



**SPEAR &  
JACKSON**

# ORIGINAL INSTRUCTION MANUAL

48cm 140cm<sup>3</sup> self propelled

# Petrol Lawnmower

**XSZ48B-SD**



**Important - Please read these instructions  
fully before starting assembly**

These instructions contain important information that will help you get the best from your mower, ensuring it is assembled correctly and safely. If you need help or have damaged or missing parts, call the Customer Helpline on 0345 605 2067

**AFTER SALES SUPPORT  
0345 605 2067**

# SPEAR & JACKSON SINCE 1760

For more than 250 years gardeners have enjoyed high quality performance and great results using Spear & Jackson tools.

Our garden power tools combine continuous innovation and the latest in manufacturing technologies with a proud heritage.

Each product is carefully designed with performance, comfort and durability firmly in mind, which has earned Spear & Jackson an enviable reputation as a maker of tools to trust.

## 3 YEARS GUARANTEE

As a testament to the quality of our products, we offer a 3 year manufacturers warranty and a comprehensive after sales service.

The warranty covers manufacturing faults, however in the event that the item has been deliberately damaged, used in a commercial environment or disassembled then the warranty will be null and void.

Please retain proof of purchase.

## 7 DAYS A WEEK TECHNICAL SUPPORT

We want you to get the best out of your products. Our easy-to-read instruction manual guides you with best practice use and maintenance tips. Please call **0345 605 2067** for technical support, we can solve around 80% of questions directly over the phone.

We hope you enjoy your product and we look forward to any feedback, as this allows us to develop even better products for the future.

# CONTENTS

<b>Safety Information.....</b>	<b>04</b>
Description of symbols.....	04
General safety.....	05
Personal safety.....	05
Operating safety.....	06
Maintenance and storage safety.....	08
Intended use.....	08
<b>Box Content / Parts.....</b>	<b>09</b>
<b>Assemble.....</b>	<b>10</b>
Unpacking.....	10
Assemble handle.....	10
Grassbagassembly.....	11
Attach cable clips.....	12
<b>Prepare .....</b>	<b>13</b>
Filling with engine oil.....	13
Filling with engine fuel.....	14
<b>Operate .....</b>	<b>16</b>
<b>Maintenance .....</b>	<b>22</b>
<b>Technical Data.....</b>	<b>29</b>
<b>Troubleshooting.....</b>	<b>31</b>
<b>Warranty.....</b>	<b>32</b>

# SAFETY INFORMATION

Please read these instructions fully before operating or maintaining your machine.

## DESCRIPTION OF SYMBOLS

The following warning symbols appear throughout this manual and indicate the appropriate safety measures you should take when operating and maintaining your lawnmower.



Read instruction handbook before operating this machine.



This symbol indicates that there is a danger of damaging your hands if you do not wear thick, hard wearing gloves.



Keep bystanders away.



Beware of sharp blades- remove spark plug lead before maintenance.



No naked flames.



Appropriate ear, eye, and head protection must be worn.



Hot surfaces will burn fingers or palms.



Warning! The lawnmower exhaust gas contains toxic substances. Do not run the engine in closed or poorly ventilated areas.



Blade continues to rotate for a period after the machine is switched off. Do not touch the blade until all the machine components have been stopped completely.



Always use high quality detergent oil classified SAE30 oil. Always use clean, fresh unleaded petrol and purchase fuel in quantities that can be used within 30 days.



Sound level data (96 dB) in accordance with Directive 2000/14/EC.



The product complies with the applicable European directives and an evaluation method of conformity for these directives was done.

# SAFETY INFORMATION

Please read these instructions fully before operating or maintaining your machine

## GENERAL SAFETY

### ! IMPORTANT!

- Keep this operating and maintenance manual in a safe place for reference at a later date.
- Read the instructions carefully. Be familiar with the controls and the proper use of the equipment.
- Never allow children or people unfamiliar with these instructions to use the lawnmower. Local regulations can restrict the age of the operator.
- Never mow while people, especially children, or pets are nearby. Keep in mind that the operator or user is responsible for accidents or hazards occurring to other people or their property.
- This appliance is not intended for use by people (including children) with reduced physical, sensory

or mental capabilities, or lack of experience and knowledge, unless they have been given supervision or instruction concerning use of the appliance by a person responsible for their safety.

- Do not touch rotating blade.

## PERSONAL SAFETY

### ! WARNING!

- While mowing, always wear substantial footwear and long trousers. Do not operate the equipment when barefoot or wearing open sandals.
- Thoroughly inspect the area where the equipment is to be used and remove all objects which can be thrown by the machine.
- Petrol is highly flammable: store fuel in containers specifically designed for

## SAFETY INFORMATION

Please read these instructions fully before operating or maintaining your machine

this purpose.

- a) Refuel outdoors only and do not smoke while refueling.
- b) Add fuel before starting the engine. Never remove the cap of the fuel tank or add petrol while the engine is running or when the engine is hot.
- c) If petrol is spilled, do not attempt to start the engine but move the machine away from the area of spillage and avoid creating any source of ignition until petrol vapours have dissipated.
- d) Replace all fuel tank and container caps securely.
- e) Stop the engine and disconnect the spark plug wire, make sure that all moving parts have come to a complete stop before refueling.

- Replace faulty silencers.
- Prior to use, visually inspect to see that the blade, blade bolts and cutter assembly are not worn or damaged. Replace worn or damaged blades and bolts in sets to preserve balance.

### OPERATION SAFETY

#### **WARNING!**

- Do not operate the engine in a confined space where dangerous carbon monoxide fumes can collect.
- Mow only in daylight or in good artificial light.
- Avoid operating the equipment on wet grass, where feasible.
- Always be sure of your footing on slopes.
- Walk, never run.
- Mow across the face of slopes, never up and down.

## SAFETY INFORMATION

Please read these instructions fully before operating or maintaining your machine

- Exercise extreme caution when changing direction on slopes.
  - Do not mow excessively steep slopes.
  - Use extreme caution when reversing or pulling the lawnmower towards you.
  - Stop the blade if the lawnmower has to be tilted for transportation when crossing surfaces other than grass, and when transporting the lawnmower to and from the area to be mowed.
  - Never operate the lawnmower with defective guards, or without safety devices, for example deflectors and/or grass catchers, in place.
  - Do not change the engine governor settings or over speed the engine.
  - Start the engine carefully according to instructions and with feet well away from the blade.
- Do not tilt the lawnmower when starting the engine.
  - Do not start the engine without the grass collector located.
  - Do not put hands or feet near or under rotating parts. Keep clear of the discharge opening at all times.
  - Never pick up or carry a lawnmower while the engine is running.
  - Stop the engine and disconnect the spark plug cable, making sure that all moving parts have come to a complete stop:
    - a) Before clearing blockages or unclogging chute.
    - b) Before checking, cleaning or working on the lawnmower.
    - c) After striking a foreign object, inspect the lawnmower for damage and make repairs before restarting and operating the lawnmower.

# SAFETY INFORMATION

Please read these instructions fully before operating or maintaining your machine

d) If lawnmower starts to vibrate abnormally, check immediately.

■ If the fuel tank has to be drained, this should be done outdoors.

## MAINTENANCE AND STORAGE SAFETY

### WARNING!

- Keep all nuts, bolts and screws tight to be sure the equipment is in safe working condition.
- Never store the equipment with petrol in the tank inside a building where fumes can reach an open flame or spark.
- Allow the engine to cool before storing in any enclosure.
- To reduce the fire hazard, keep the engine, silencer, and petrol storage area free of grass, leaves, or excessive grease.
- Check the grass bag frequently for wear or deterioration.
- Replace worn or damaged parts for safety.

## INTENDED USE

This lawnmower is designed for domestic use only:

- This petrol lawnmower is intended for mowing lawns in domestic and hobby gardens.
- This product is not to be used in wet weather conditions and may not be used to mow wet or unusually high grass, e.g. pasture grass or for shredding leaves.
- This product is intended for private domestic use only, not for any commercial trade use. It must not be used for any purposes other than those described.

Any use of the machine that deviates from its intended use and is not included in these.

# BOX CONTENTS

## PARTS

- |  |   |
|--|---|
| <b>1</b> Upper handle with soft grip   | <b>9</b> Engine   |
| <b>2</b> Start/Stop bar                | <b>10</b> Steel deck  |
| <b>3</b> Upper handle quick release x2 | <b>11</b> Lower Handle fixing knob with nut M8 and arch-head bolts x2 |
| <b>4</b> Grass collecting bag          | <b>12</b> Plug wrench x1  |
| <b>5</b> Lower handle                  | <b>13</b> Cable clip x1   |
| <b>6</b> Safety flap                   | <b>14</b> Propulsion lever  |
| <b>7</b> Height adjustment handle      | <b>15</b> Plastic mulching plug                                       |
| <b>8</b> Wheel                         | <b>16</b> Side discharge chute  |

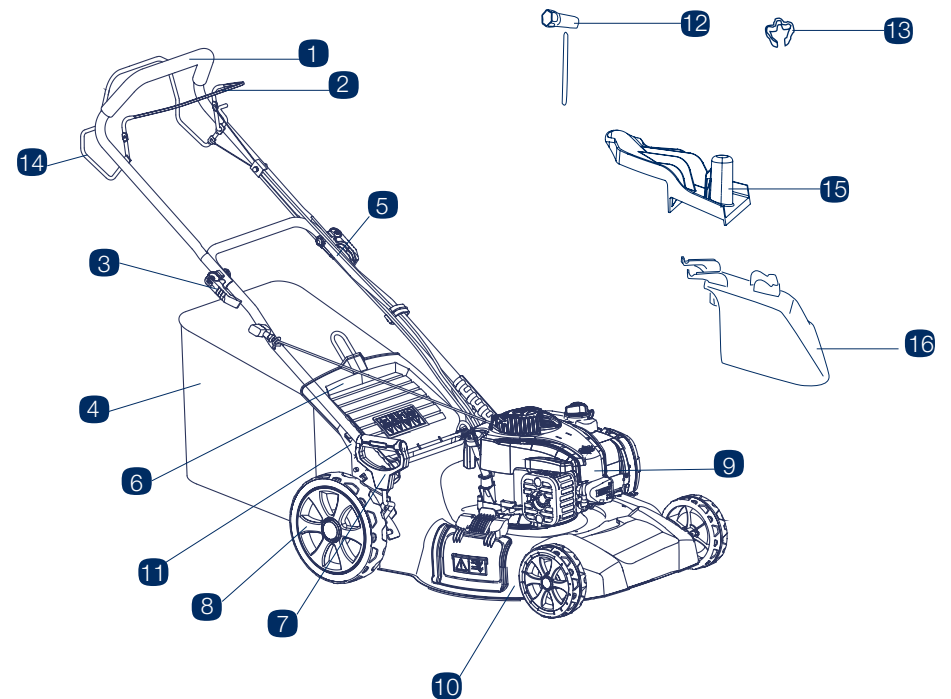

Items required, but not included

- SAE30 or 4-stroke oil
- Unleaded fuel
- Funnel

If there are any parts missing, please call the customer helpline on **0345 605 2067**

# ASSEMBLE

**! WARNING! Wear proper gloves!**

## 1 Unpacking

- i. Unpack all parts and lay them on a flat, stable surface.
- ii. Remove all packing materials and shipping devices if applicable. Box should be kept for duration of warranty.
- iii. Make sure the delivery contents are complete and free of any damage. If you find that parts are missing or show damage do not use the product but contact your dealer. Using an incomplete or damaged product represents a hazard to people and property.
- iv. Ensure that you have all the accessories and tools needed for assembly and operation. This also includes suitable personal protective equipment.

## 2 Assemble handle

- i. Remove the packaging from the handle. Set the height adjustment to lowest position, and align the lower handle with the holes in the deck. Make sure the holes in the lower handle are aligned with those in the support.

**Note: Ensure the rope guide is on the right side, when you stand behind the mower.**

- ii. Fix the lower handle onto the deck firmly, using the lower handle fixing bolts and knobs (11) supplied.

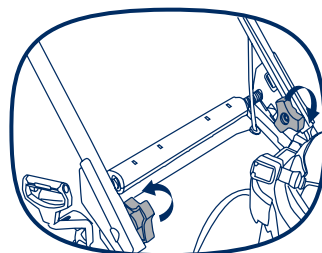
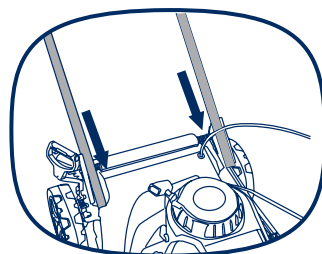

# ASSEMBLE

- iii. Lift the upper handle, and lock in place using the quick release lever and tensioning bolts that are attached to the handle. Ensure the lower and upper handles are firmly connected.

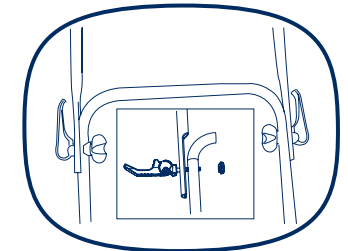

- iv. Ensure the rope guide is on the right side, when you stand behind the mower. Pull on/off lever and gently pull the rope. Hook it around the guide rope.

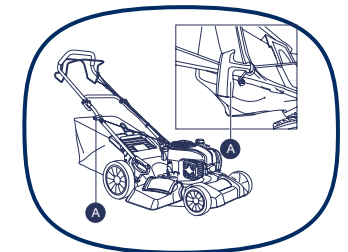

## 3 Grass bag assembly

**! IMPORTANT! Make sure the grass collection bog is in place before starting the engine.**

- i. Attach the grass bag to the frame by fixing all plastic hooks.

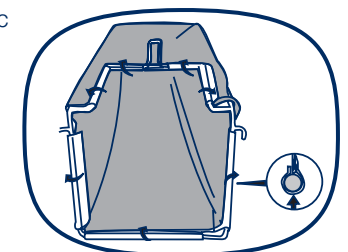

## ASSEMBLE

- ii. Raise the safety flap (6), and hook the collection bag onto the mower.

Release the safety flap.

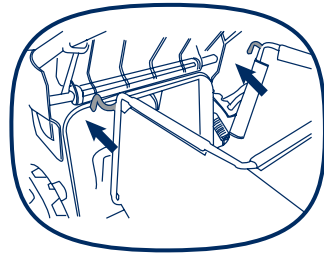

### 4 Attach cable clips

Ensure that the cable clips supplied are used to fix the cable to the lower handle.

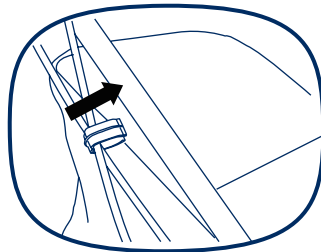

## PREPARE



**DO NOT START THE ENGINE BEFORE PUTTING 500ML OF SAE 30 OIL INTO THE ENGINE.**

**FAILURE TO DO SO WILL RESULT IN IRREPARABLE DAMAGE TO THE ENGINE AND INVALIDATE YOUR WARRANTY.**

### 1 Filling with engine oil



#### IMPORTANT!

- The following procedures and adjustments must be performed before the engine is started. Do not attempt to make any of these adjustments while the engine is running.

This engine is shipped without oil or petrol, any oil residue is from testing prior to shipping.

The engine must be filled with the correct grade of oil and petrol before starting the engine.

Running the engine with a low oil level will cause engine irreparable damage.

Always use high quality detergent oil classified SAE30 oil (or equivalent eg 5W/30, often termed as 4 Stroke lawn mower oil). Only use additives recommended by the engine manufacturer. To prolong the life of your engine, it is important that the oil is changed after the first 5 hours of use.

Using non-detergent oil can shorten the engine's service life and using 2-stroke oil will damage the engine.

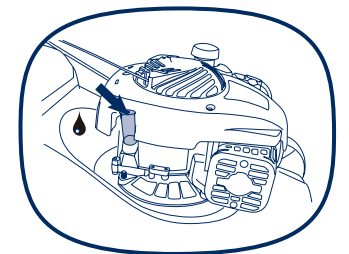

## PREPARE

Check the engine oil level with the engine stopped and the mower on a level surface.

- Remove the oil filler dipstick and wipe oil from it with a clean cloth.
- Insert the dipstick into the oil filler neck, and screw it in.
- Then remove the dipstick and check the oil level. The oil level must be between the Min and Max marks on the dipstick. If near the lower level, fill to upper level with the recommended oil (SAE30 or equivalent). Do not overfill. Wipe away any spilt oil.

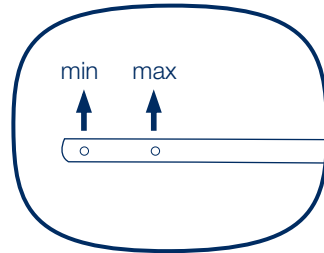

**Before first time using, add 0.5 litres oil (SAE 30).**

## 2 Filling with engine fuel



### WARNING!

- Refuel in a well-ventilated area with the engine stopped. Do not smoke or allow flames or sparks in the area where the engine is refueled or where petrol is stored. Avoid repeated or prolonged contact with skin or inhalation of vapour.



### CAUTION!

- Petrol is highly flammable and extreme caution must be taken when handling or working with it. Keep out of reach of children.

- Clean the area around the petrol filler cap before removing the cap. Check the fuel level.
- Refill the tank if the fuel level is low.
- Always use clean, fresh unleaded petrol and purchase fuel in quantities that can be used within 30 days.

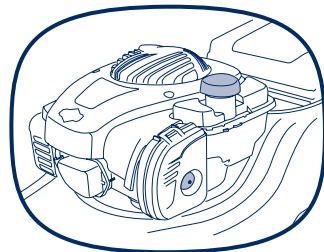

## PREPARE

- Never mix oil with petrol.
- Refuel carefully to avoid overfilling or spilling fuel to allow for expansion. There should be no fuel in the filler neck.
- Clean up any overflow or splashes of petrol before starting the engine.

Tighten the filler cap after filling, finger tight only.

**NOTE! The Spear & Jackson 48cm Self Propelled Lawnmower has a maximum fuel capacity of 800ml.**



# OPERATE

## 1 Setting the cutting height



### WARNING!

-The blade can cause serious injury. Before adjusting the mower height, stop the engine and wait for the mower blade to come to a complete stop.

- i. Pull the lever towards the wheel, then move it forward or backward to adjust the cutting height.
- ii. Move it to any one of the 7 positions(25mm~75mm) for the desired cutting height.
- iii. Return lever into securing plate.

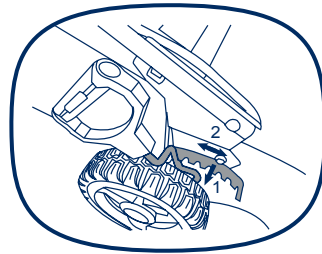

Position	Approx. cutting height (mm)
1	25mm
2	28mm
3	34mm
4	43mm
5	53mm
6	64mm
7	75mm

**NOTE!** Never use the lowest cutting height for the first cut of the season or in drought conditions. Only about one thirds of the grass height should be cut.

## 2 Starting the engine



### WARNING!

Do not operate the machine in enclosed or poorly ventilated areas as the exhaust gas contains toxic substances. Keep hands, feet, hair and clothing away from all the moving parts of the machine. The exhaust and other parts of the machine will become hot during use. Make sure that the blade is securely fastened before starting the engine.

# OPERATE



### WARNING!

While mowing, always wear substantial footwear and long trousers. Do not operate the equipment when barefoot or wearing open sandals.

### i. Starting procedure quick guide

Before starting the engine, make sure that the spark plug cap is located on the plug and the machine is filled with sufficient oil and petrol.

PRIMER BULB 3~5 TIMES	START STOP BAR CLOSED	PULL STARTING KNOB	PROPULSION LEVER CLOSED

### ii. Press the primer bulb (A) 3-5 times.

When starting a cold engine, press down the primer fully 3~5 times.

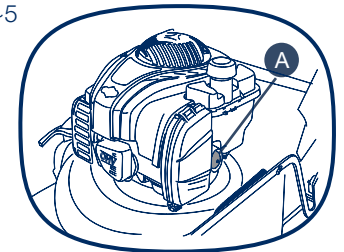

Pressing the primer button too many times could cause the engine to flood.

**NOTE!** When starting a warm engine, the primer does not need to be used. If the engine stops due to a lack of petrol, refill and press down the primer 3~5 times.

### iii. Pull the Start/Stop bar towards you.

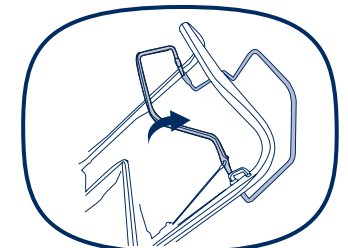

# OPERATE

- iv. With right hand, slowly but firmly pull the starter handle and rope from the pull cord guide until you feel resistance, then pull briskly. If the engine fails to start after three pulls, repeat the start process. When the engine starts, return the starter rope to the pull cord guide gently.

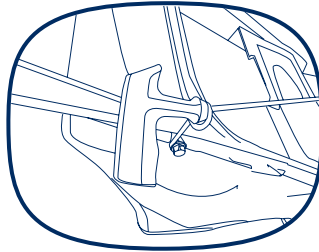

- v. Pull up the propulsion or self propelled lever to engage the self drive function.

- vi. Release the stop/start bar to stop the machine.

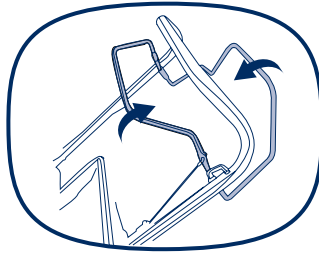

**Note! If the engine won't start after you have operated the starter several times, the engine may be flooded with excess fuel.**

Use following procedure to clear and start a flooded engine:

- i. Release the stop/start bar.
- ii. Remove the spark plug, dry it, and wait 30 second to 1 minute to allow excess fuel vapour to dissipate from the cylinder. Refer to page 25.
- iii. Reinstall the spark plug carefully by hand, to avoid cross-threading. After the plug is seated, tighten 1/8 to 1/4 turn with the plug wrench (12) to compress the washer.
- iv. Pull the stop/start bar towards the upper handle.
- v. Operate the starter as described above.

# OPERATE

## 3 Mowing with grass bag



### WARNING!

Always observe the strictest safety procedures when using the lawnmower. Always fit the grass bag before mowing.

### i. Mowing with grass bag (Be sure to remove the side discharge chute and take out the mulching plug)

- Start the engine and allow it run. See "Step-2 Starting the engine"
- Keep a firm grip on the upper handle with stop/start bar and walk bar closed and walking along it self-propelling, never run with the mower, be very careful when mowing uneven or rough ground. Mow across slopes, never up and down. Be careful when changing the direction of the mower on a slope. Do not use the mower on a steep slope of more than 15°.

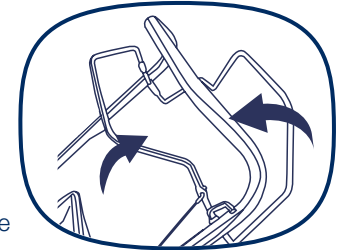

### ii. Mowing with mulching

When mulching, remove the collection grass bag, and put the plastic mulching plug into the rear discharge chute. Then release the flap, it will close back to cover the mulching plug.

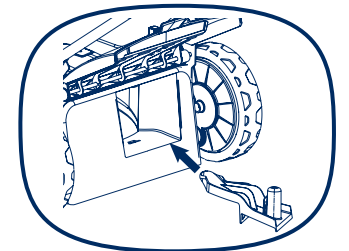
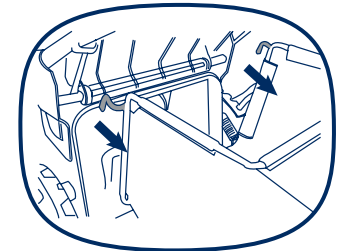

# OPERATE

## iii. Mowing with side discharge.

When using side discharge to throw grass, remove the grass collection bag and insert the mulching plug.

- Push the locking button open with one hand.

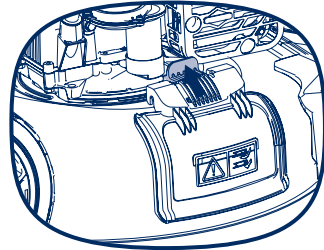

- Raise the side safety flap with other hand.

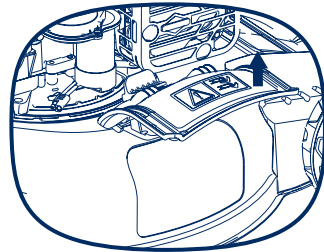

- Hold the flap opening, hook the side discharge chute onto the mower and release the safety flap.

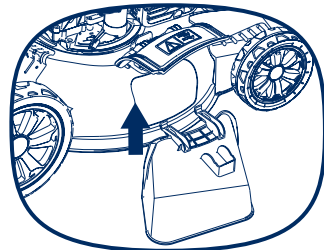

### NOTE!

- **The best result will be achieved if the grass is dry. Wet grass will tend to clog the blade and the grass collection system. Grass grows at different rates at different times of the year.**
- **Never use the lowest cutting height for the first cut of the season or in drought conditions. Only about one thirds of the grass height should be cut.**
- **If the lawnmower will not collect the cuttings efficiently, the grass discharge chute may be blocked. The grass bag may be full, or the underside of the mower deck may be clogged.**

# OPERATE

## 4 Emptying the grass bag

- i. Raise the safety flap with one hand and remove the grass bag using its handle with your other hand. To maintain safety, the safety flap will close back to cover the mulching plug, when you release the safety flap.

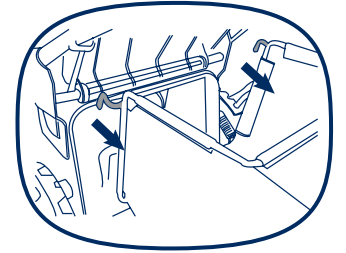

- ii. Empty the grass debris from the grass collection bag, and refit grass collection bag. If any grass residues are caught in the discharge chute, clean it using a brush.

# MAINTENANCE

## Storing the lawnmower for short periods

After mowing, please follow the below actions prior to placing the lawnmower in storage.

- Allow the engine to fully cool.
- Ensure the grass bag is empty.
- Clean all debris from under the mower deck.
- Store the lawnmower on flat and level surface with all 4 wheels on the ground.
- Store in a safe place which is not accessible by children or people who are not familiar with operation.

## Storing the lawnmower for extended periods



### CAUTION!

Do not empty the petrol tank in enclosed areas, near fire or when smoking. Petrol fumes can cause explosions and fire.



### WARNING!

- Before you tip the lawn mower onto its side, completely empty the fuel tank using a petrol suction pump.
- Never turn the mower upside down.
- Before commencing any maintenance always disconnect the spark plug.

- If the lawnmower is to be placed into storage at the end of the season or if the mower is not to be used for a longer period than 6 weeks, storage maintenance must be performed on the lawnmower.
- Temperature fluctuations cause condensation which contaminates fuel and causes starting problems. Simply emptying the machine of fuel will prevent this.

# MAINTENANCE

- Empty the petrol tank with a petrol suction pump if available or use the tipping method if a large quantity of fuel needs to be removed.
- To remove smaller quantities of fuel, simply start the engine and let it run until any remaining petrol has been used up.
- Change the oil at the end of every season. To do so, remove the used engine oil from warm engine and refill with fresh oil.
- Clean the cooling fins of the cylinder and the housing.
- Be sure to clean the entire machine to protect the paint.
- Store the machine in a well-ventilated place.

**NOTE:** Alternatively adding Briggs & Stratton FUEL FIT to the fuel will prevent contaminated fuel. Not all additives on the market do this.

## Preparation to re-use

- Check oil level before starting the engine and ensure of sufficient oil level, see page 13.
- Check spark plug inserted correctly, see page 18.
- Fill engine with fresh unleaded fuel, see page 13 and 14.
- Follow starting procedure, see page 17.

# MAINTENANCE

## Maintenance schedule

Performing routine maintenance correctly on your lawnmower will ensure you get years of trouble free use.

Please keep this manual safe for future reference.

It is recommended that the following maintenance schedule is adhered to. This will ensure the lawnmower operates correctly and is safe to use.

	after every use	12 hours after use	24 hours after use	36 hours after use
Cleaning	clean	clean	clean	clean
Air filter		clean	clean	replace
Sprak plug		check	check	replace
Engine oil	check	check	check	check
Cutting blade	check	check	check	replace



**WARNING!** The engine oil should be changed after the first 5 hours.

## Cleaning

- To ensure long life and good performance of the machine it's important to keep the machine clean and well lubricated. Make sure the chute is clean and under the deck is cleared from wet debris. See also short term storage.
- Do not allow grass cuttings and other debris to become dry and hard on any of the mower surfaces. This will directly affect the cutting and grass collection performance. Make sure that the underside of the lawnmower deck is clean and clear.

# MAINTENANCE

- Never clean the lawn mower with a water jet or high-pressure cleaner. The engine must remain dry. Do not use aggressive cleaning agents such as cold cleaner or petroleum ether.

## Cleaning or replacing air filter



**WARNING!** Never run the engine without the air filter element installed.

- Loosen the fastener that holds the cover.
- Open the cover and remove the filter.
- To loosen debris, gently tap the filter on a hard surface. If the filter is excessively dirty, replace with a new filter.
- Install the filter.
- Install the cover tabs into the slots.
- Close the cover and secure with the fastener.

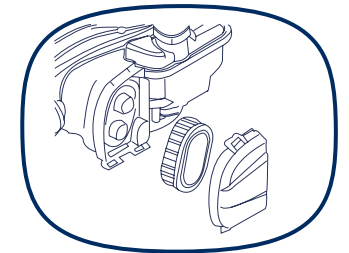

## Cleaning or replacing spark plug

- Once the engine has cooled, pull off the spark plug boot with a twist. Remove the spark plug using the wrench supplied.

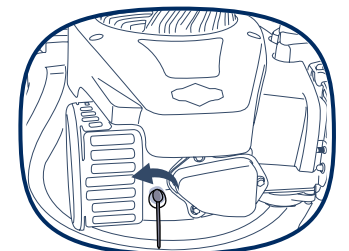
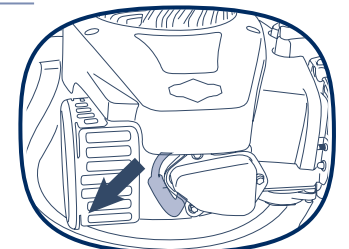

## MAINTENANCE

- Clean the spark plug with a wire brush.
- Using a feeler gauge set the gap to 0.51 mm.

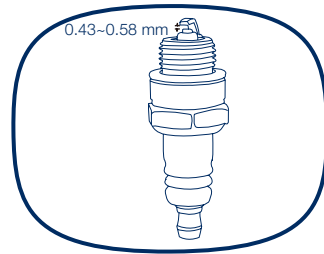

- Install the spark plug carefully by hand, to avoid cross-threading.
- After the spark plug is seated, tighten with the spanner to compress the washer.

### Changing the oil

- Running the engine for a few minutes prior to draining will allow the oil to pour more easily.
- Tilt the lawnmower towards the oil filler, have a container ready to catch the oil and remove the dipstick. Once the oil has been emptied, wipe clean any spillages.
- Refill with 500ml SAE30 oil or equivalent ie SAE5W/30, SAE10W/30). When the dipstick is screwed into the filler pipe, the oil level must be between the min and max marks on the dipstick.
- See "Filling with Engine Oil". Do not overfill.
- Start the engine and allow it to run briefly.
- Stop the engine, wait one minute and check the oil level. Top up if necessary.

## MAINTENANCE

### Replacing cutting blade



#### WARNING!

- Before you remove the grass collection bag, stop the engine and wait until the blade has come to a complete stop.
- You will need garden gloves (not provided) and a spanner wrench to remove the blade.
- Always handle the blade with care- sharp edges could cause injury USE GLOVES.
- Don't hold the blade by hand directly.

#### RENEW YOUR METAL BLADE AFTER 50HRS MOWING OR 2 YEARS WHICHEVER IS SOONER REGARDLESS OF CONDITION.

Regularly check your blade. If the cut of your grass is poor, the blade might be blunt. Damaged blades not only result in a bad cut, they cause excessive vibration and uneconomical running of the engine. If the blade has worn excessively and become pitted and blunt, it should be replaced or sharpened.

**NOTE!** The blade carrier is designed to break under heavy blade impact to protect the machine. if this happens also replace the blade carrier.

- Tip the machine slightly towards the oil filler pipe and reach under the deck.
- Hold the blade and unscrew the blade bolt counterclockwise using a spanner wrench. Remove the washer and the blade.
- Inspect the blade adaptor for any signs of damage.
- Fit a new blade, locate the blade on the two studs on the blade flange and then replace the washer and bolts.

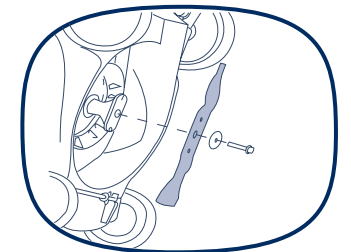

## MAINTENANCE

- v Check the washer is still slightly domed to keep the pressure on the bolt to stop it unwinding, keeping the blade firmly secure. Replace the washer (right way round!) and bolts. Note: If washer has lost its dome and become flat it must be replaced.
- vi Make sure the blade is correctly located, and then firmly tighten the bolt. Do not over tighten. The upturn of the blade must project into the motor compartment.

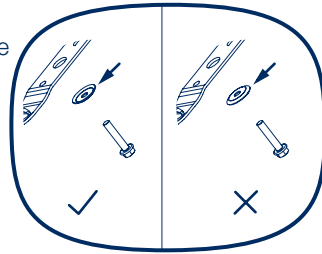

**NOTE!** If you are unsure about performing this operation call our helpline or go to an authorized dealer to change the blade for you.

### Recycling and disposal

- The product comes in a package that protects it against damage during shipping. Keep the packaging until you are sure that all parts have been delivered and the product is functioning properly. Recycle the packaging afterwards.
- Old products are potentially recyclable and do not, therefore, belong in your household rubbish. You are requested to assist us and our contribution to saving resources and protecting the environment by handing in this product at an equipped collection centre (if there is one available).

## TECHNICAL DATA

Property	Value
Engine type	Single cylinder 4-stroke
Engine displacement	140cm <sup>3</sup>
Engine power	2.1kW/ 2900/min
Max Engine speed	2900/min
Cutting width	48cm
Grass bag capacity	60L
Ignition	T.C.I
Fuel tank capacity	0.8L
Oil tank capacity	0.5L
Measured sound power level	93 dB(A)
Guaranteed sound power level	96 dB(A) K=3dB(A)
Vibration	6.1 m/s <sup>2</sup> k=1.5m/s <sup>2</sup>
Spark type	QC12YC
Net weight	30kg

The sound values have been determined according to noise test code given in ENISO5393-1:2013, using the basic standards EN ISO 11094:1991, ENISO3744:1995&Annex III of 2000/14/EC as amended by 2005/88/EC.

The sound intensity level for the operator may exceed 80dB(A) and ear protection measures are necessary.

The declared vibration value has been measured in accordance with a standard test method (according to EN ISO 5395-1:2013, Annex G) and may be used for comparing one product with another. The declared vibration value may also be used in a preliminary assessment of exposure.

**WARNING!** Depending on the actual use of the product the vibration values can differ from the declared total! Adopt proper measures to protect yourself against vibration exposures! Take the whole work process including times the product is running under no load or switched off into consideration!

Proper measures include among others regular maintenance and care of the product and cutting attachments, keeping hands warm, periodical breaks and proper planning of work processes!

## TECHNICAL DATA

PART NUMBER	ACCESSORIES
QC12YC	Spark plug
958905	Collection grass bag
958214	Blade
916204	Blade bolt
466018	Lower handle fixing knob
428029	Upper handle quick release

## TROUBLESHOOTING

Suspected malfunctions are often due to causes that the user can fix themselves. Therefore, check the product using this section. In most cases the problem can be solved quickly.



**WARNING!** Only perform the steps described within these instructions! All further inspection, maintenance and repair work must be performed by an authorised service centre or a similarly qualified specialist if you cannot solve the problem yourself!  
Gloves and appropriate protective clothing must be worn when performing these instructions.

Fault	Possible Cause	Solution
Loud while running, machine vibrates heavily	<ul style="list-style-type: none"> <li>-Screws are loose</li> <li>- Blade fasteners are loose</li> <li>-Blade is unbalanced</li> </ul>	<ul style="list-style-type: none"> <li>- Check screws</li> <li>- Check blade fasteners</li> <li>- Replace blade</li> </ul>
Engine does not start	<ul style="list-style-type: none"> <li>- Start/stop bar not pressed</li> <li>- Primer bulb is empty</li> <li>- Spark plug is defective</li> <li>- Fuel tank is empty</li> <li>- Engine may be flooded</li> </ul>	<ul style="list-style-type: none"> <li>- Press start/stop bar</li> <li>- Press primer bulb 3~5 times.</li> <li>- Replace spark plug</li> <li>- Refill with fuel</li> <li>- remove plug and dry, see page 18</li> </ul>
Engine runs unsteadily	<ul style="list-style-type: none"> <li>- Air filter is soiled</li> <li>- Spark plug is soiled</li> </ul>	<ul style="list-style-type: none"> <li>- Clean the air filter</li> <li>- Clean the spark plug</li> </ul>
Uneven mowing results	<ul style="list-style-type: none"> <li>- Blade is blunt</li> <li>- Cutting height is too low</li> </ul>	<ul style="list-style-type: none"> <li>- Sharpen the blade</li> <li>- Set correct height</li> </ul>
Unsatisfactory grass collection	<ul style="list-style-type: none"> <li>- Cutting height is too low</li> <li>- Blade is worn</li> <li>- Grass bag is clogged</li> </ul>	<ul style="list-style-type: none"> <li>- Set correct height</li> <li>- Replace the blade</li> <li>- Clear any clogged grass debris</li> </ul>



# WARRANTY

If your device develops a fault, please don't hesitate to contact our customer service department on 0345 605 2067, the majority of problems can be solved directly on the phone.

1. These warranty terms cover additional warranty rights and do not affect your statutory warranty rights. All our products are covered by a 3 year manufacturer warranty.
2. Claims must be accompanied by proof of purchase. This must be in the form of a Sales receipt or bank statement and must show that the product has been purchased within the warranty period as described under point 1, from the retailer that it was originally bought from. Please keep your receipt safe or staple it to the back of this manual for future reference.
3. Our warranty covers problems caused by material or manufacturing defects, and will result in the repair of these defects or replacement of the device with a like for like or similar article.
4. Our devices have not been designed for commercial, trade or industrial applications, any signs of use of the equipment in these application or equivalent activities, invalidates the warranty.
5. The following are also excluded from our warranty:
  - A. Faults due to accidents, customer misuse or unauthorized repairs
  - B. Consumable Parts such as blades, quick release locks, extension cables, wheels, grass bags and other accessories that are compatible with the product.
  - C. Failure due to lack of routine maintenance.
  - D. Failure as a result of not using the equipment in accordance with the manual and safety instructions
  - E. The adjustment of cables, drives belts or recoil starters.

Warranty claims should be submitted before the end of the warranty period, see point 1, but a paid service exists for repairs commissioned after this period. The original warranty period remains applicable to the device even if repairs are carried out or parts are replaced.

In such cases, the work performed or parts fitted will not result in an extension of the warranty period, and no new warranty will become active for the work performed or parts fitted.

If you have any problems or questions concerning your garden power tool, please contact our after sales service at 0345 605 2067.