

RMB45MCBL/SS

User Guide

&

Installation & Service Instructions



U110666 - 03

Contents

1. Before You Start...	1	3. Installation	29
Installation and Maintenance	1	Before The Installation	29
Before First Use	1	Location of the Oven	29
Personal Safety	1	Electrical Connection	32
Cleaning	2	4. Circuit Diagram	33
2. Oven Overview	3	5. Technical Data	34
Setting the clock for the first time	4	6. Warranty/After Sales Service	35
Changing the time	4		
What kind of ovenware can be used?	5		
Cooking with microwave	5		
Using the Microwave	7		
Setting the delayed start for the Microwave	8		
Cooking with the Grill	9		
Using the Grill	9		
Setting the delayed start for the Grill	10		
Using the Convection	11		
Setting the delayed start for the Convection	12		
Using the Microwave Grill	13		
Setting the delayed start for the Microwave Grill	14		
Using the Grill Convection	15		
Setting the delayed start for the Grill Convection	16		
Using the Microwave Convection	17		
Setting the delayed start for the Microwave Convection	18		
Using the Microwave Grill Convection	19		
Setting the delayed start for the Microwave Grill Convection	20		
Defrosting with microwaves	21		
Using the Defrost	22		
Setting the delayed start for Defrost	23		
Pause during cooking	24		
Cancel cooking	24		
Child Lock	24		
Modifying Parameters	24		
Cooling Fan	25		
Door Interlock Switch	25		
Troubleshooting	26		

1. Before You Start...

Thank you for buying a Rangemaster Microwave Combo Oven. It should give you many years trouble-free cooking if installed and operated correctly. It is important that you read this section before you start, particularly if you have not used a Microwave Combo Oven before.

⚠ CAUTION: This appliance is for cooking purposes only. It must not be used for other purposes, for example room heating. Using it for any other purpose could invalidate any warranty or liability claim. Besides invalidating claims this wastes fuel and may overheat the control knobs.

Installation and Maintenance

The electrical installation should be in accordance with BS 7671, or with the relevant national and local regulations. Have the installer show you the location of the oven control switch and mark it for easy reference.

It is recommended that this appliance is serviced annually. Only a qualified service engineer should service the oven, and only approved spare parts should be used.

Make sure that the oven is wired in and switched on.

Always allow the oven to cool and then switch it off at the mains before cleaning or carrying out any maintenance work, unless otherwise specified in this guide.

This appliance is for household use and complies with EEC directives. This appliance can only be used for cooking and heating food.

Before First Use

Before using the oven for the first time clean it thoroughly. Switch off the unit at the isolator or mains supply. Remove all packing materials and accessories. Using hot water and a mild detergent, wipe the oven interior and then rinse carefully with a damp cloth. Wash the oven shelves and accessories in a dishwasher or using hot water and a mild detergent and dry thoroughly.

Personal Safety

- ⚠ Accessible parts will become hot during use and will retain heat even after you have stopped cooking. Keep babies and children away from the oven.**
- ⚠ When the oven is not in use, ensure that the control knobs are in the OFF position.**
- ⚠ To minimise the possibility of burns, always be certain that the controls are in the OFF position and that the entire oven is cool before attempting to clean.**
- ⚠ Cooking high moisture content foods can create a 'steam burst' when the oven door is opened. When opening the oven door stand well back and allow any steam to disperse. Take care that no water seeps into the appliance.**
- ⚠ Use dry oven gloves when applicable – using damp gloves might result in steam burns when you touch a hot surface. Never operate the oven with wet hands. DO NOT use a towel or other bulky cloth in place of a glove – it might catch fire if it touches a hot surface.**
- ⚠ Always keep combustible wall coverings or curtains, etc., a safe distance away from your oven, and never wear loose-fitting or hanging clothes while using the appliance.**
- ⚠ DO NOT store or use aerosols, or any other potentially combustible or flammable materials, in the vicinity of the oven.**
- ⚠ DO NOT pour spirits (e.g. brandy, whisky, schnapps, etc.) over hot food. Danger of explosion!**
- ⚠ Care should be taken to avoid touching the heating elements inside the main oven.**
- ⚠ Whole chickens and large joints of meat should be defrosted thoroughly in the refrigerator. Do not defrost in a warm oven or while the adjoining oven is in operation or still warm.**
- ⚠ When the oven is on, DO NOT leave the door open for longer than necessary.**
- ⚠ NEVER heat unopened food containers. Pressure build-up may cause the containers to burst and cause injury.**
- ⚠ DO NOT use aluminium foil to cover vents, shelves, linings or the oven roof.**
- ⚠ This appliance is heavy, so take care when moving it.**
- ⚠ The appliance is not intended to be operated by means of external timer or separated remote-control system.**
- ⚠ DO NOT lean on the oven door when open. This may damage the oven, especially in the hinge zone. The door can bear a maximum weight of 8 kg.**

- ⚠** This appliance can be used by children aged from 8 years and above and persons with reduced physical, sensory or mental capabilities or lack of experience and knowledge if they have been given supervision or instruction concerning use of the appliance in a safe way and understand the hazards involved.
- ⚠** Children less than 8 years of age should be kept away unless continuously supervised. Children shall not play with the appliance. Cleaning and user maintenance shall not be made by children without supervision.
- ⚠** To avoid condensation, do not leave cooked food longer than necessary.
- ⚠** To get the best cooking out of your oven, we recommend that you pour fresh water before cooking.

Cleaning

- ⚠** Before attempting to clean the oven, switch off from the mains.
- ⚠** After cooking we recommend that you clean any residue left from the cooked food and the condensation produced on the inner glass of the oven immediately.
- ⚠** DO NOT use harsh abrasive cleaners or sharp metal scrapers to clean the oven door glass since they can scratch the surface, which may result in shattering of the glass.
- ⚠** NEVER use paint solvents, washing soda, caustic cleaners, biological powders, bleach, chlorine based bleach cleaners, coarse abrasives or salt.
- ⚠** DO NOT mix different cleaning products – they may react together with hazardous results.
- ⚠** Avoid using any abrasive cleaners, including cream cleaners. For best results, use a liquid detergent or use a soft cloth wrung out in clean hot soapy water.
- ⚠** In the interests of hygiene and safety, the oven should be kept clean at all times as a build up in fats and other foodstuffs could result in a fire.
- ⚠** Clean only the parts listed in this guide.
- ⚠** Clean with caution. If a wet sponge or cloth is used to wipe spills on a hot surface, be careful to avoid steam burns. Some cleaners can produce noxious fumes if applied to a hot surface.

2. Oven Overview

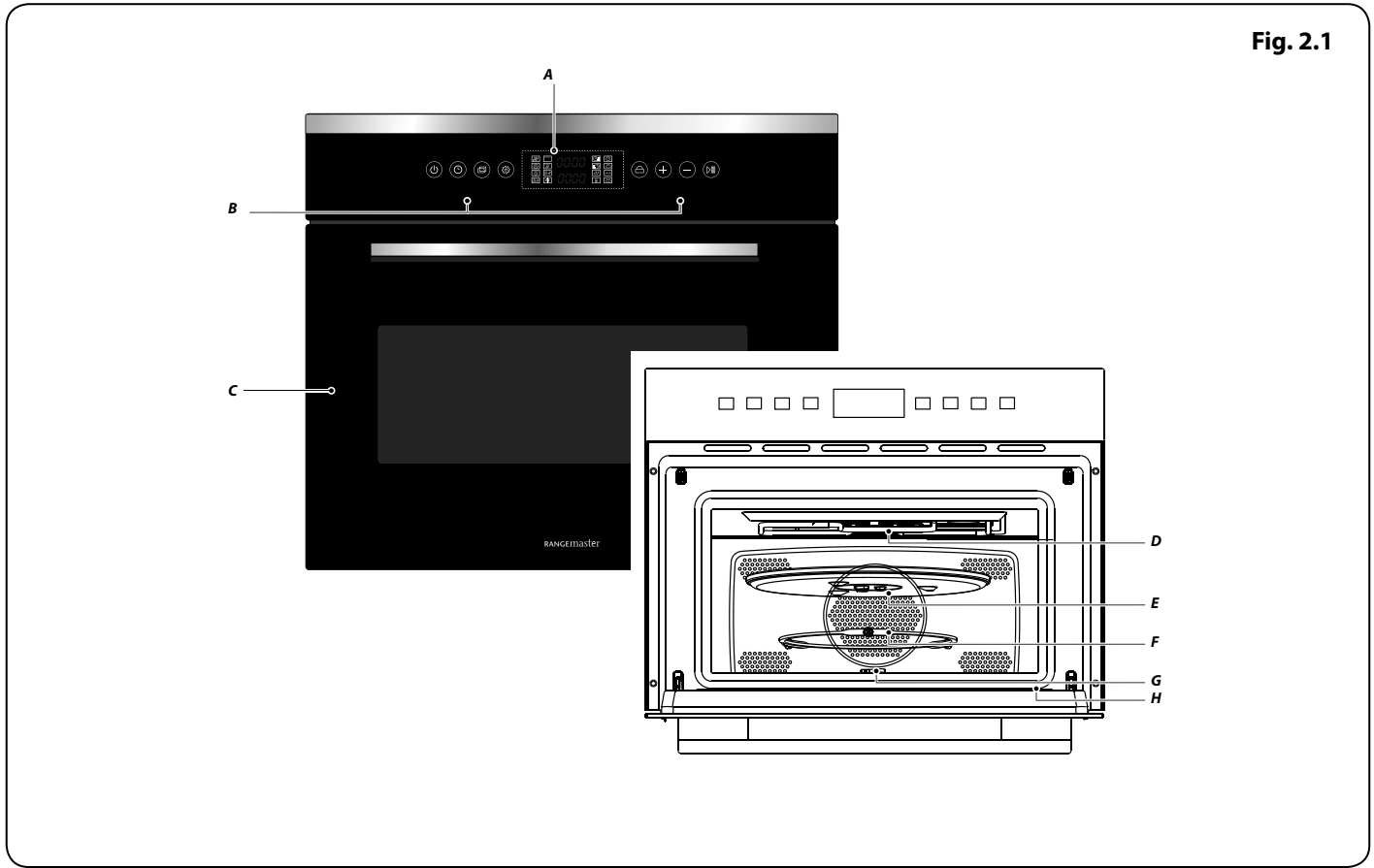

Fig. 2.1

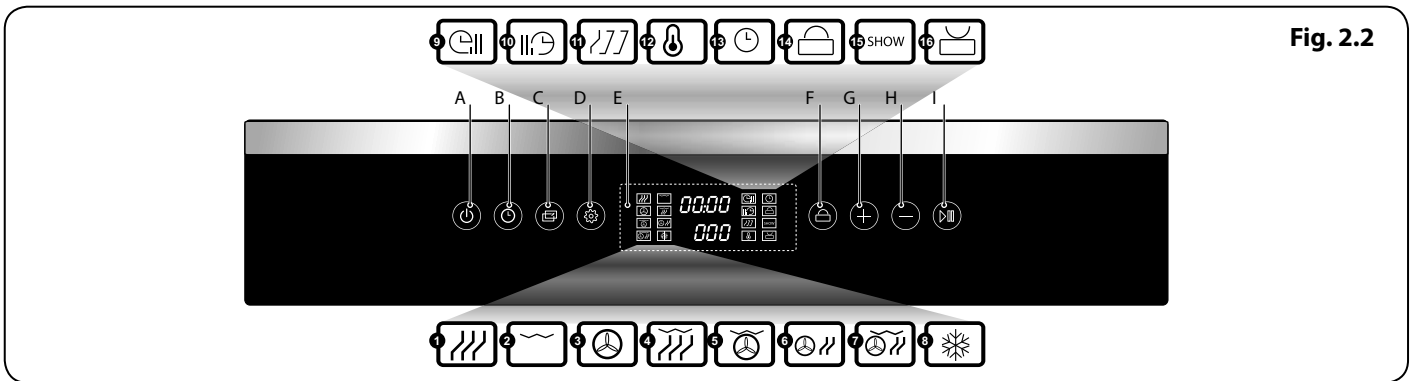

Fig. 2.2

The Microwave Combo oven (**Fig. 2.1**) has a 8-function oven cavity with a touch sensitive control panel.

Key: Fig. 2.1

- A.** Function Display
- B.** Controls
- C.** Microwave Combo Oven
- D.** Grill
- E.** Turntable Plate
- F.** Turntable Ring
- G.** Drive Shaft
- H.** Door Seal

Key: Fig. 2.2

- | | | |
|-------------------------------|--------------------------------------|----------------------------|
| A. ON /OFF button | 1. Microwave | 9. Cooking Duration |
| B. Timer Setting | 2. Grill | 10. Delay time |
| C. Function Adjustment | 3. Convection | 11. Microwave Power |
| D. Set/Confirm | 4. Microwave Grill | 12. Temperature |
| E. Display | 5. Microwave Convection | 13. Clock |
| F. Child Lock | 6. Grill Convection | 14. Child Lock |
| G. + | 7. Microwave Grill Convection | 15. Show |
| H. - | 8. Defrost | 16. Weight |
| I. Start / Pause | | |

Setting the clock for the first time

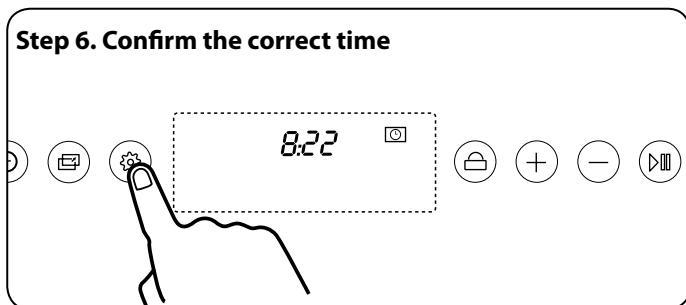
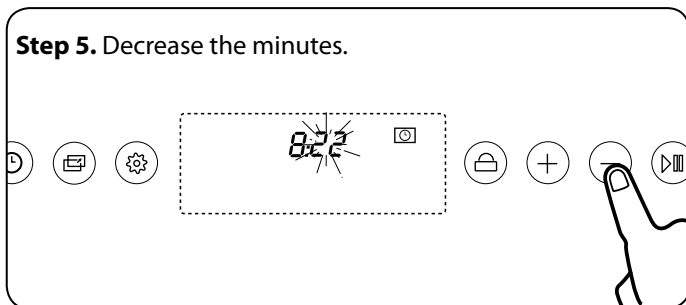
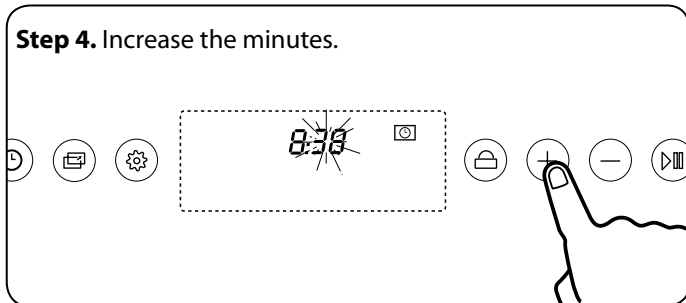
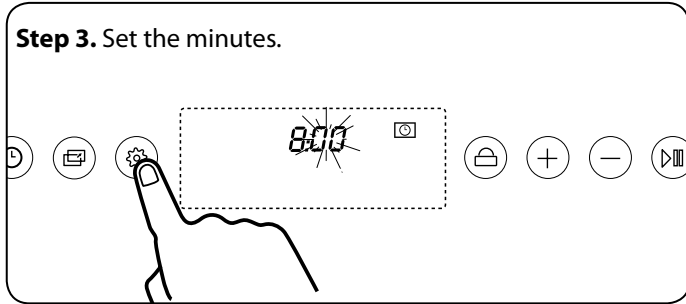
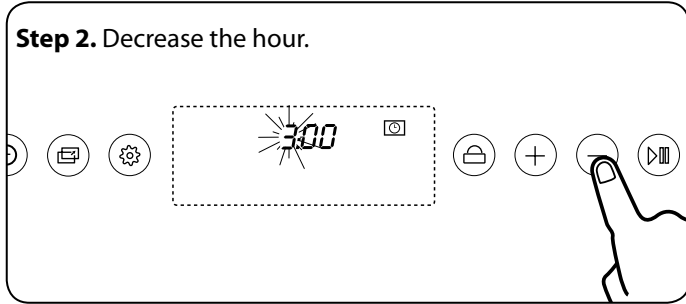
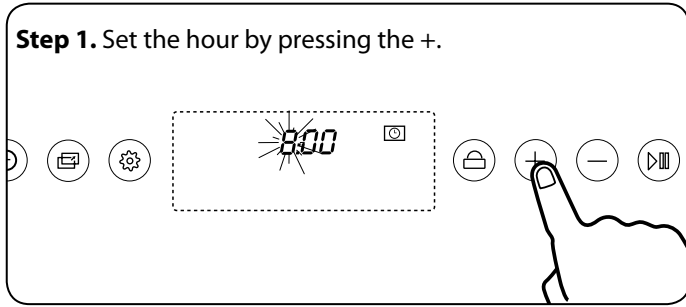

Changing the time

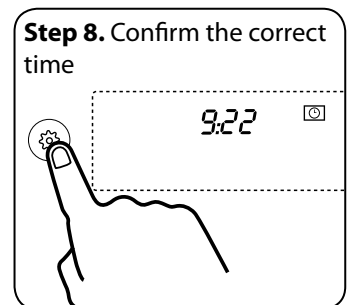
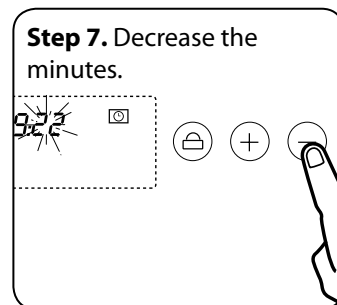
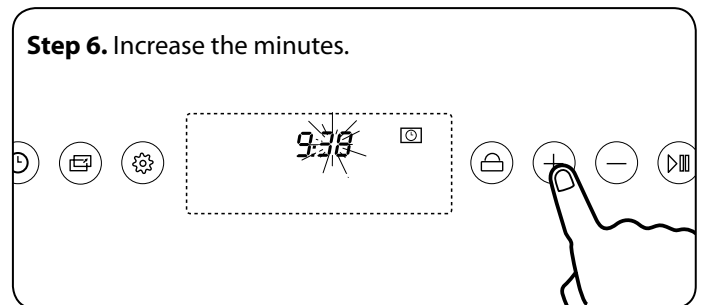
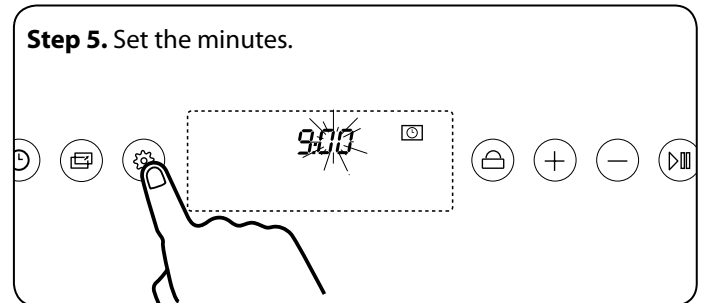
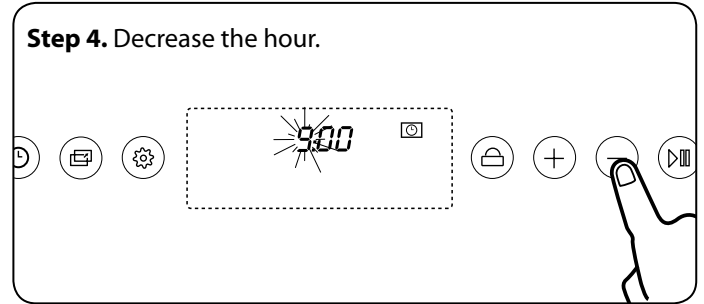
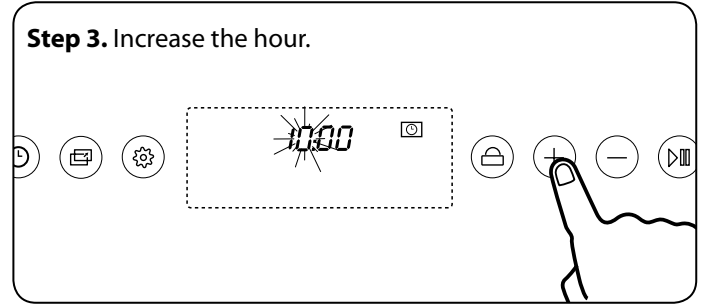
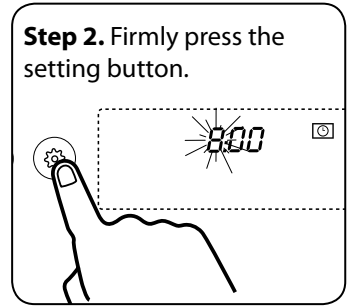
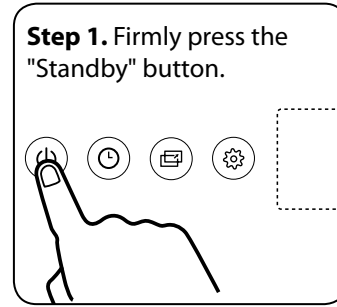

What kind of ovenware can be used?

Microwave function

Metal pans, dishes or containers with metal parts or decorations cannot be used in the microwave. Glassware and clay with metallic decoration or content (e.g. lead crystal) cannot be used for microwave oven.

The ideal material for microwave oven is glass, refractory china or clay, or heat resistant plastic. Very thin, fragile glass or china should only be used for short period of time (e.g. heating)

To test ovenware, put the item in the oven for 20 seconds at maximum microwave power, after 20 seconds, take the ovenware out immediately, it is suitable to use if it is cold or just slightly warm. However, it is not suitable for microwave oven if it heats up a lot or causes electric arcing.

Grilling

In the case of the grill function, the ovenware should be resistant to temperature of at least 300°C. Plastic dishes are not suitable for the grill function.

Combination functions

In the combination functions (microwave + conventional heating elements), the ovenware used should be suitable for microwave and grill.

Aluminum containers and foil

Pre-cooked food in aluminum containers or in aluminum foil can be put in the microwave if the following aspects are respected.

Please read the manufacturer's recommendations written on the external packing.

The aluminum containers cannot be more than 3 cm high or come in contact with the cavity walls (minimum distance 3 cm). Any aluminum lid or top should be removed.

The cooking time is longer because the microwaves only permeate into food from the top. If you have any doubts, it is best to use only dishes suitable for microwave use.

⚠ Aluminum foil cannot come into contact with the cavity walls since this may cause electrical arcing.

Lids

We recommend you use glass or plastic lids or cling film:

- In case of excessive evaporation (mainly during very long cooking times)
- Cooking time is shorter
- The aroma is preserved

To prevent a build-up of pressure when cooking in sealed containers, the lid should have holes or openings to allow for sufficient ventilation. Plastic bags should be opened. Baby feeding bottles or jars with baby food and similar containers can only be heated without tops/lids on, otherwise they may burst.

Cooking with microwave

⚠ Read the safety instructions before using your microwave

- Before heating or cooking foods with peel or skin (e.g. apples, tomatoes, potatoes, sausages) peel them so that they do not burst. Cut the food up before starting to prepare it.
- Before using a container or dish make sure that it is suitable for microwave use.
- When cooking food with very little moisture (e.g. defrosting bread, making popcorn, etc.) evaporation is very quick. The oven then works as if it was empty and the food may burn. The appliance and the container may be damaged in such situation. You should therefore

set just the cooking time necessary and you should keep a close eye on the cooking process.

- If you have several containers, such as cups, for example, set them out uniformly on the turntable plate
- **DO NOT** seal plastic bags with metal clips. Use plastic clips instead. Prick the bags for several holes so that the steam can escape.
- Check that they reach at least a temperature of 70°C. When heating or cooking foods.
- Steam on the oven door during cooking may start to appear. This situation is normal and may be more noticeable if the room temperature is low. The process of cooking is not affected by this. After you have finished cooking, clean up the water coming from the condensation.
- When heating liquids, use containers with a wide opening, so that the steam can evaporate easily.
- Prepare the foods as per the instructions and keep in mind the cooking times and power levels indicated in the tables.
- Keep in mind that the figures given are only indicative and can vary depending on the initial state, temperature, moisture and type of food. It is depending on the initial state, temperature, moisture and different types of food. It is advisable to adjust the times and power levels to each situation. Depending on the exact characteristics of the food you may need to increase or shorten the cooking times or increase or decrease the power levels.
- The greater the amount of food, the longer the cooking time. Keep in mind that: Double the quantity = double the time. Half the quantity = half the time
- The lower the temperature, the longer the cooking time.
- Foods containing a lot of liquid heat up more quickly
- Cooking will be more uniform if the food is evenly distributed on the turntable. If you put dense foods on the outer part of the plate and less dense ones on the centre of the plate, you can heat up different types of food simultaneously.
- You can open the oven door at any time. When you do this the oven switches off automatically. The microwave will only start working again when you close the door and press the start key.
- It takes less time if we put a cover over food, but the cover should have vents avoiding extreme pressure.

Using the Microwave

Step 1. Firmly press the "Standby" button.

Step 2. Overview of the display

Step 3. Press the "Timer" to set the time.

Step 4. Increase time.

Step 5. Decrease time.

Step 6. Press the "Function" button to change/set the power rating. Refer to **Table 2.1 Microwave rating**.

Step 7. Increase the power rating.

Step 8. Decrease the power rating.

Step 9. Press the "Pause/Start" button to confirm the setting.

NOTE:

At the end of each cooking process the oven will emit 3 beeps every 30 seconds for five minutes or until the oven door is open or when you press the **Start / Pause**.

Setting the delayed start for the Microwave

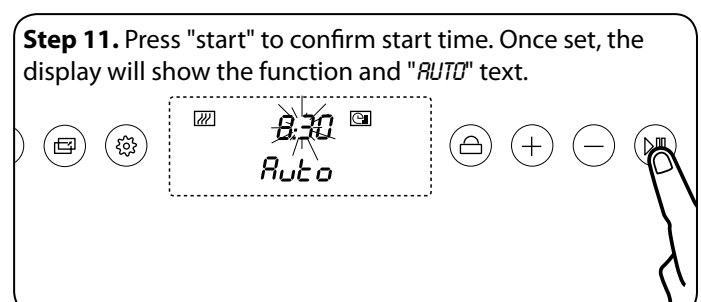
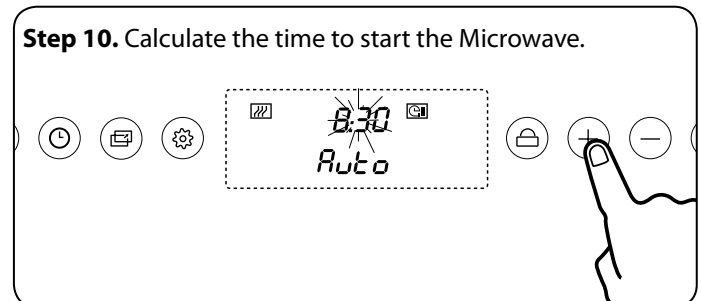
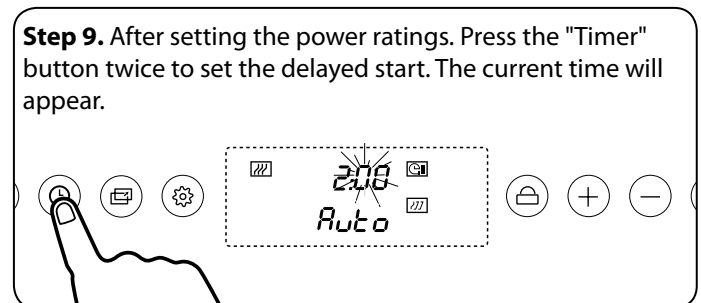
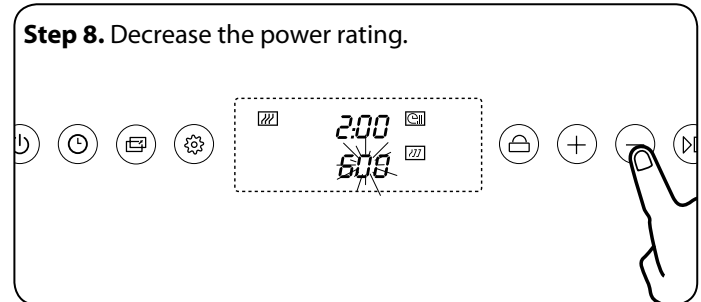
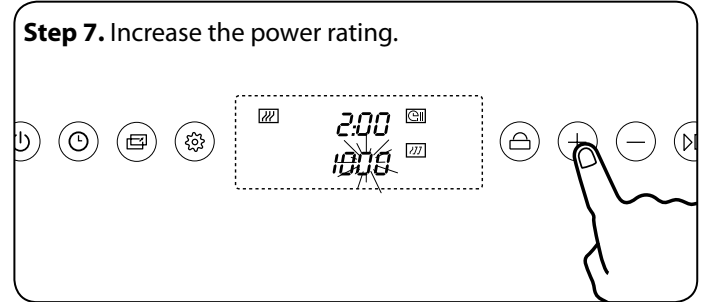
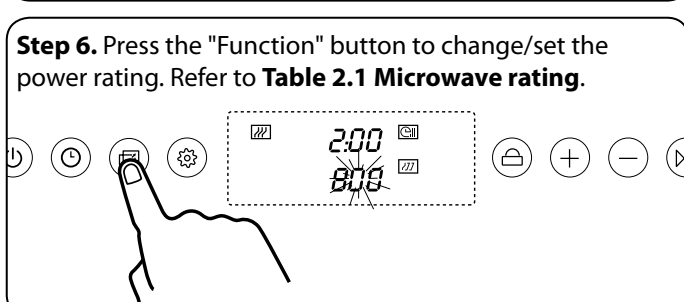
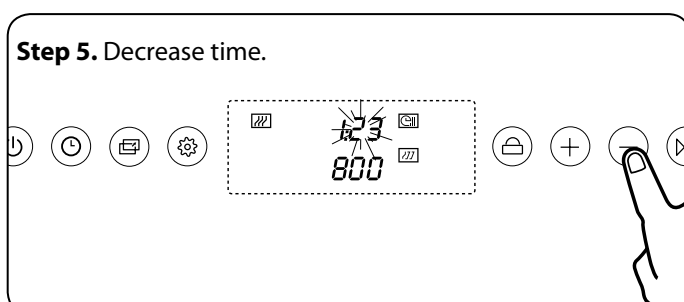
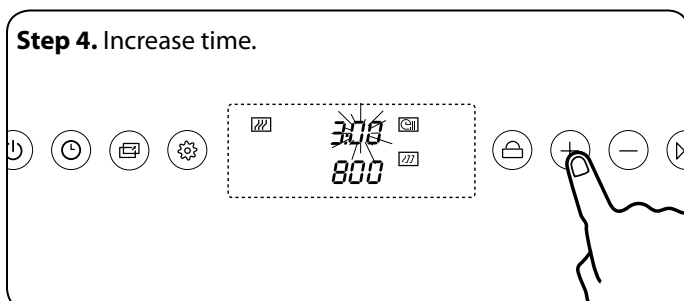
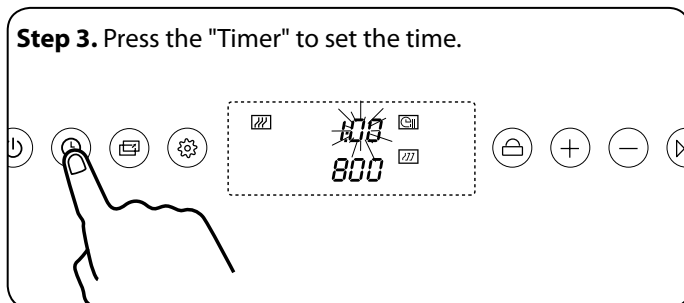
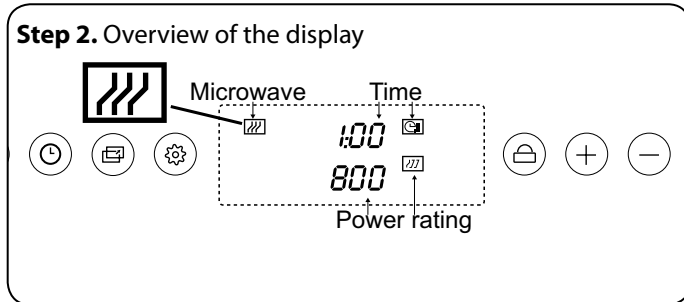
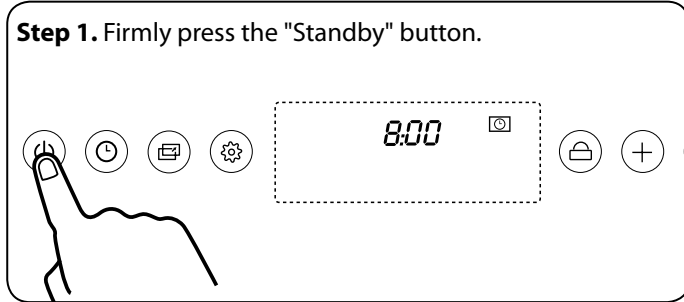

NOTE:
At the end of each cooking process the oven will emit 3 beeps every 30 seconds for five minutes or until the oven door is open or when you press the **Start / Pause**.

Cooking with the Grill

Table 2.6 page 28

⚠ IMPORTANT POINTS:

- There will be some smoke and smell when the grill is used for the first time. That is because of oil left from the manufacture process.
- The glass of oven door becomes very hot when the oven is working. Keep children away.
- When the grill is used for extended period of time, it is normal to find that the elements will switch themselves off temporarily due to the safety thermostat.
- Important: When food is to be grilled or cooked in containers you should check that the container is suitable for microwave use. See the section on types of ovenware!
- When the grill is used it is possible that some splashes of fat may go onto the elements and be burnt. This is a normal situation and does not mean there is any kind of operation fault.
- After you have finished cooking, clean the interior and the accessories so that cooking remains do not become encrusted.

Using the Grill

Step 1. Firmly press the "Standby" button.



Step 2. Press the + button to choose Grill

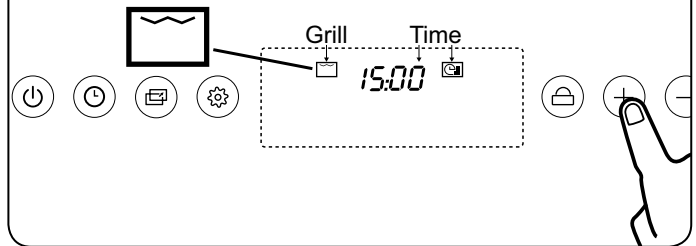

Step 3. Press the "Timer" to set the time.

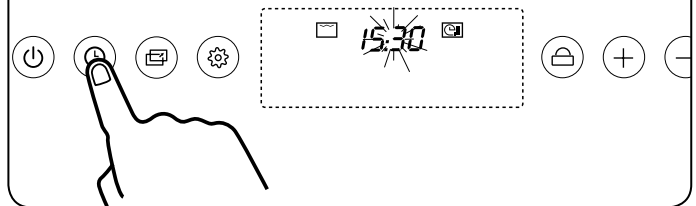

Step 4. Increments of + and - of 30secs

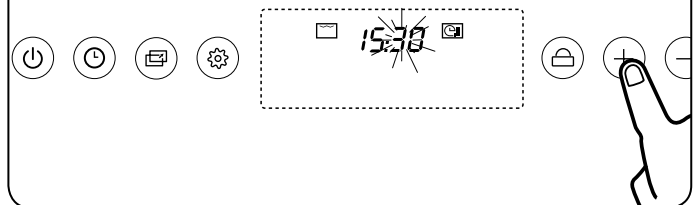

Step 5. Press the "Pause/Start" button to confirm the setting.

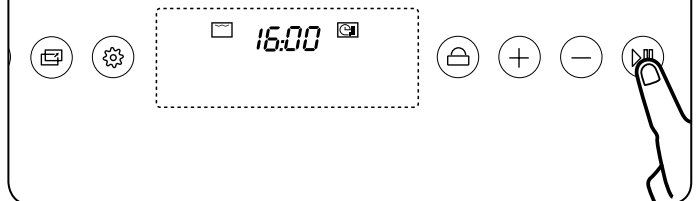

NOTE:

At the end of each cooking process the oven will emit 3 beeps every 30 seconds for five minutes or until the oven door is open or when you press the **Start / Pause**.

Setting the delayed start for the Grill

Step 1. Firmly press the "Standby" button.

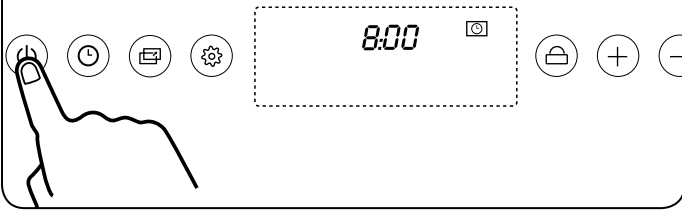

Step 2. Press the + button to choose Grill

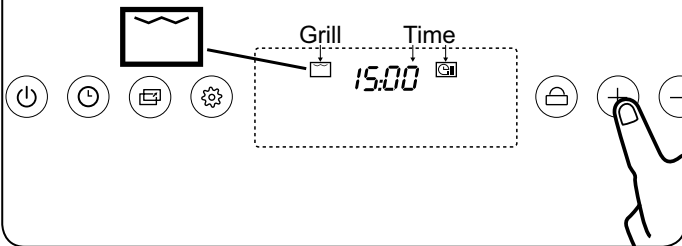

Step 3. Press the "Timer" to set the time.

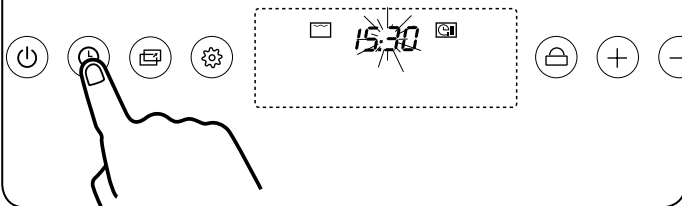

Step 4. Increments of + and - of 30secs

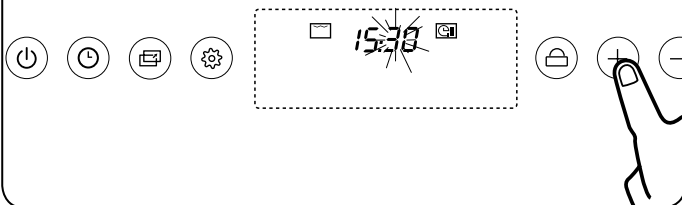

Step 9. After setting the cooking duration. Press the "Timer" button twice to set the delayed start. The current time will appear.



Step 6. Calculate the time to start the Grill.

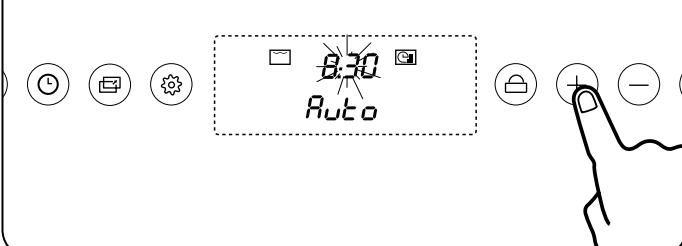

Step 7. Press "Start" to confirm start time. Once set, the display will show the function and "AUTO" text.

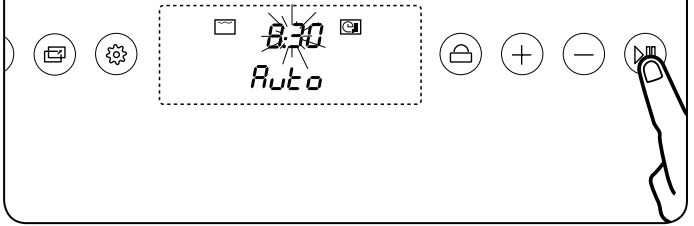

NOTE:

At the end of each cooking process the oven will emit 3 beeps every 30 seconds for five minutes or until the oven door is open or when you press the **Start / Pause**.

Using the Convection

Step 1. Firmly press the "Standby" button.

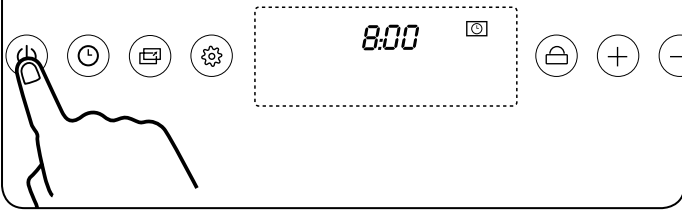

Step 7. Decrease temperature.

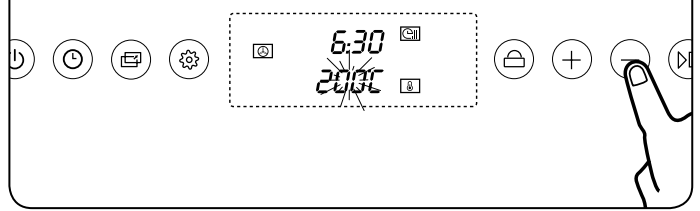

Step 2. Press the + button to choose Convection.

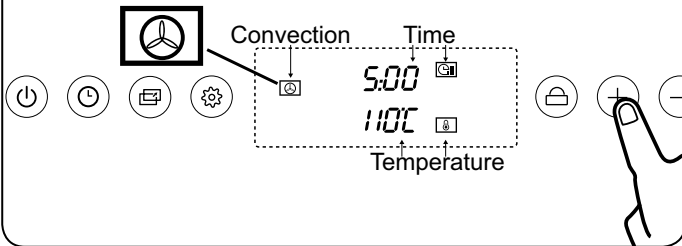

Step 8. Press the "Pause/Start" button to confirm the setting.

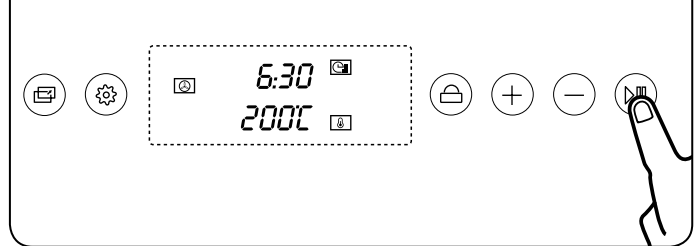

Step 3. Press the "Timer" to set the time.

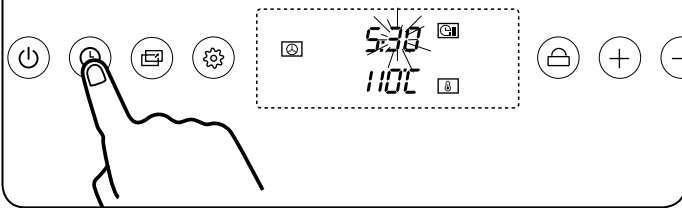

Step 9. Press the "Childlock" button, to confirm if the convection oven has reached your desired temperature.

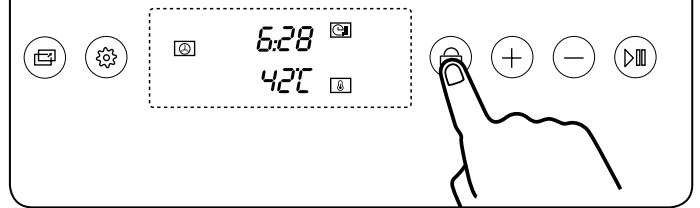

Step 4. Set the time. Increments of + and - of 30secs.

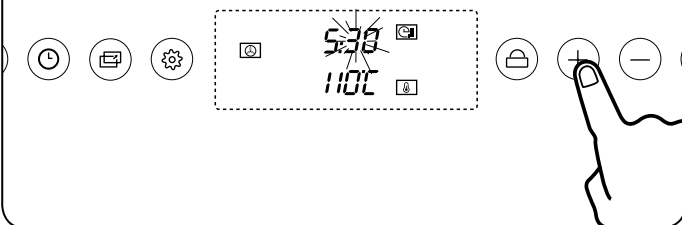

NOTE:

At the end of each cooking process the oven will emit 3 beeps every 30 seconds for five minutes or until the oven door is open or when you press the **Start / Pause**.

Step 5. Press the "Function" to set the temperature.

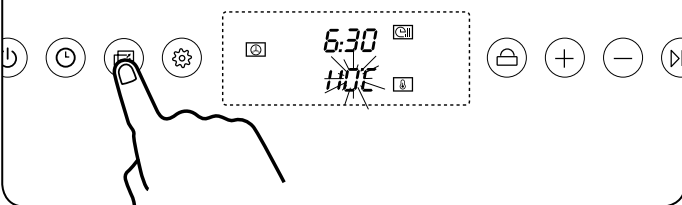

Step 6. Increase temperature.

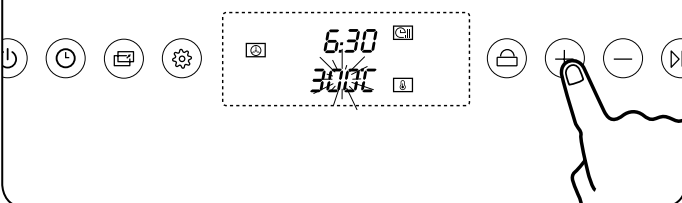

Setting the delayed start for the Convection

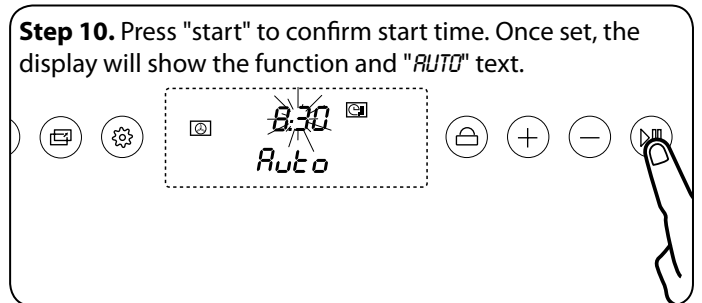
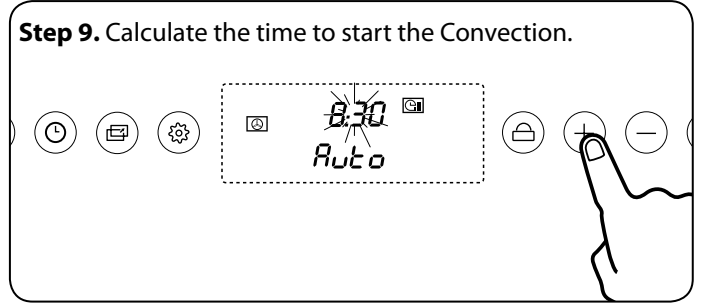
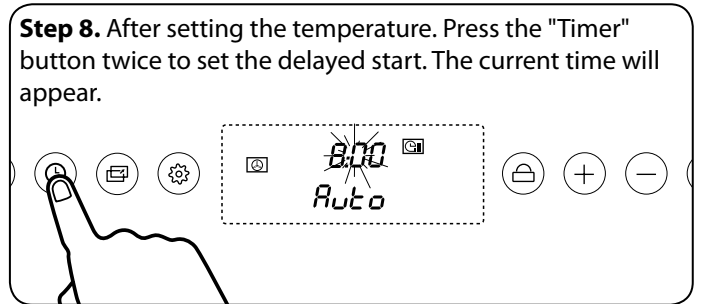
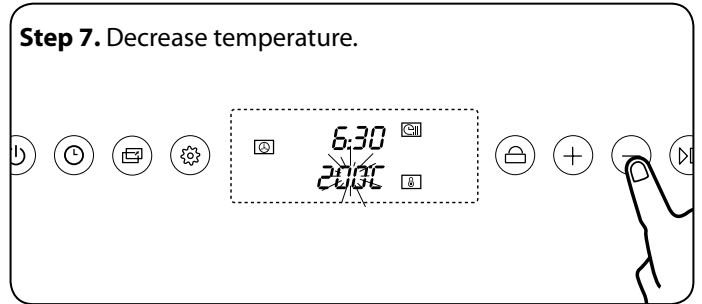
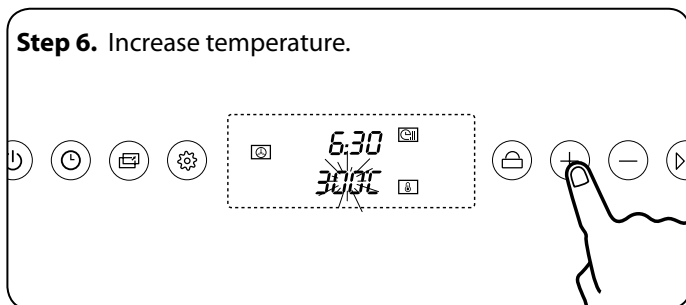
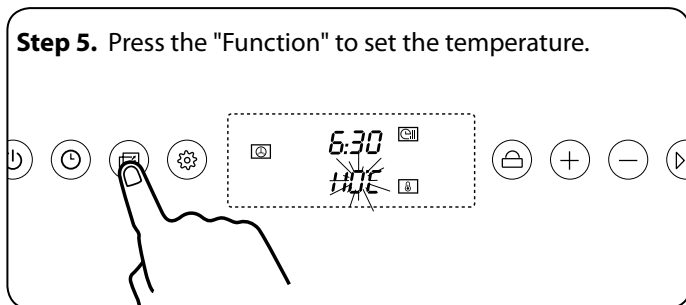
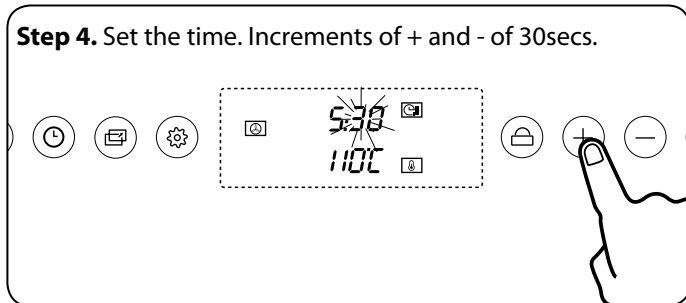
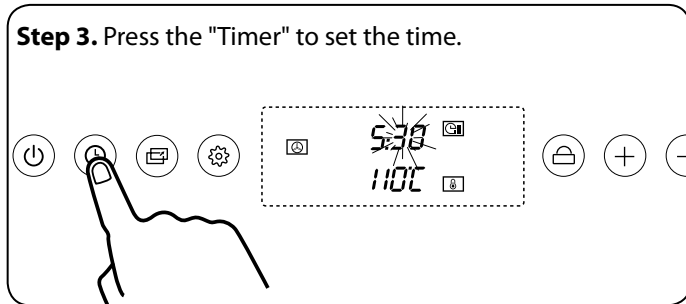
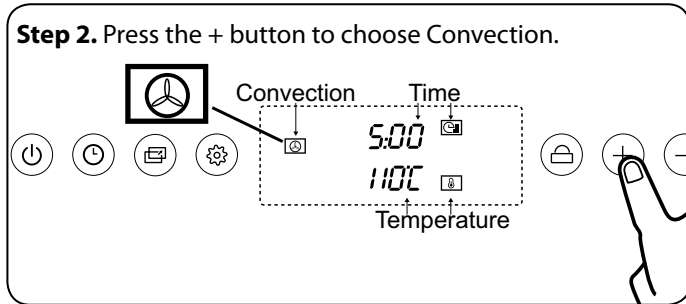
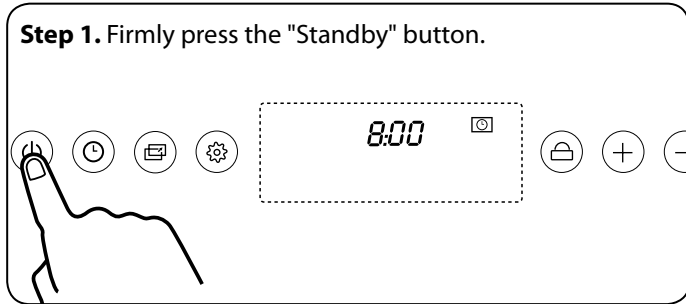

NOTE:

At the end of each cooking process the oven will emit 3 beeps every 30 seconds for five minutes or until the oven door is open or when you press the **Start / Pause**.

Using the Microwave Grill

The microwave and the grill work simultaneously and it is ideal for quickly browning foods after cooking.

Make sure your cookware and/or dish is suitable for microwave grill and that it is also suitable for microwave use.

The cookware and/or dish to be used in the combined function should adhere to **Table 2.2 Microwave Grill ratings**. The values given in the table are valid when there is no preheat.

The control settings and cooking times given in the **Table 2.2 Microwave Grill ratings** are intended to be used **AS A GUIDE ONLY**. Individual tastes may require the temperature to be altered to provide a preferred result.

Please allow for standing time and unless otherwise instructed do not forget to turn the meat pieces.

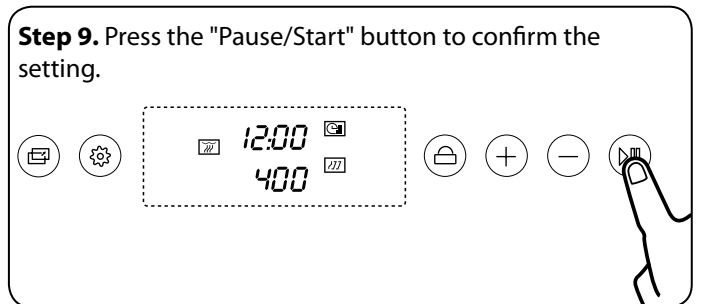
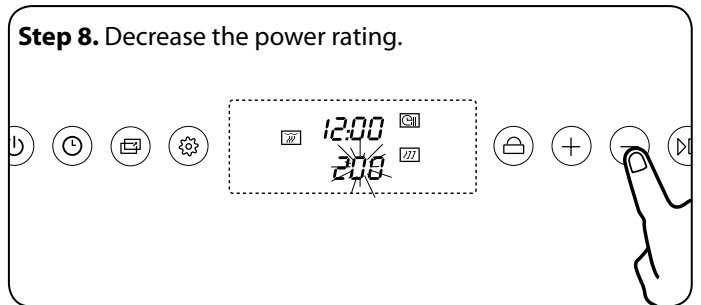
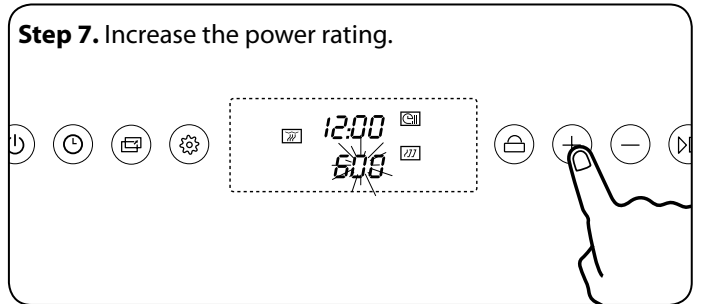
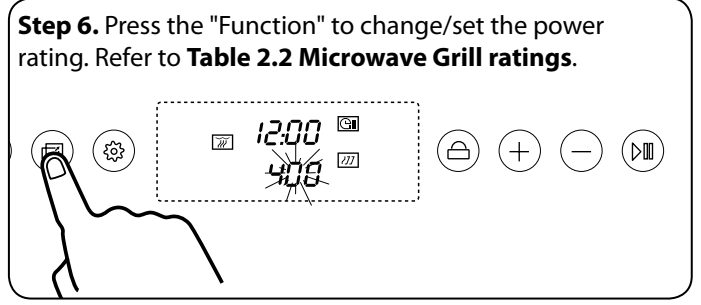
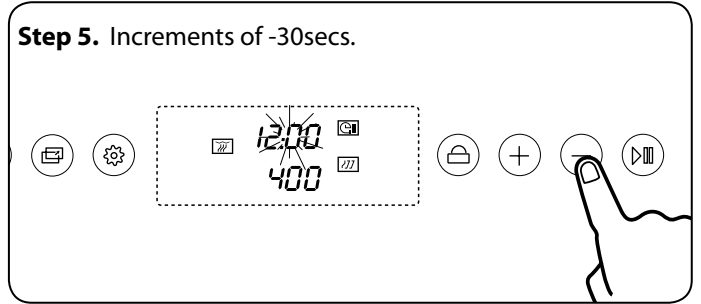
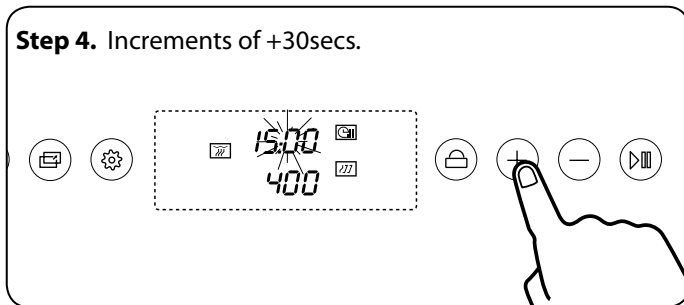
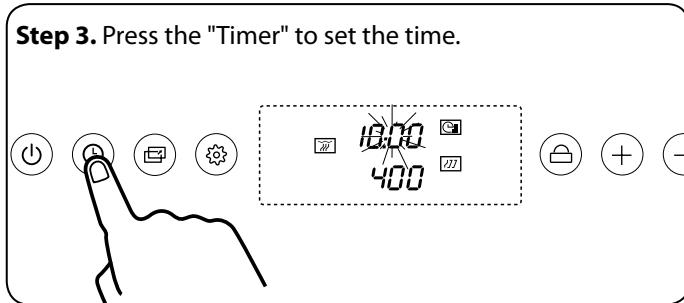
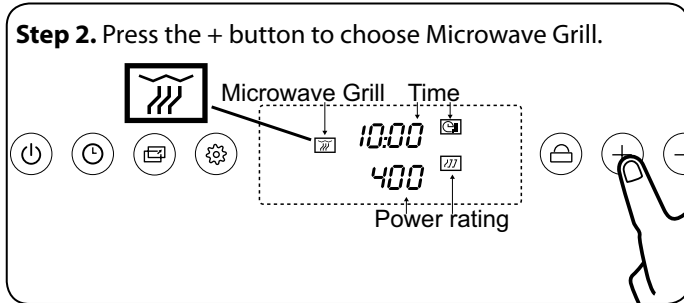
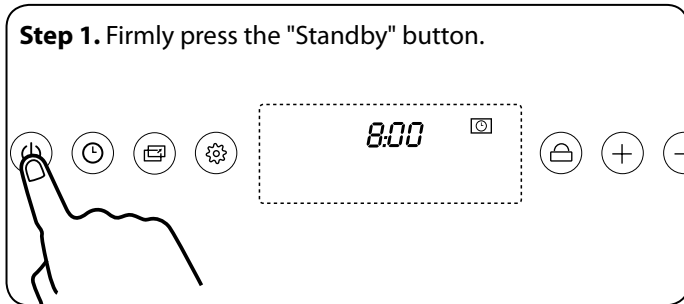

NOTE:

At the end of each cooking process the oven will emit 3 beeps every 30 seconds for five minutes or until the oven door is open or when you press the **Start / Pause**.

Setting the delayed start for the Microwave Grill

Step 1. Firmly press the "Standby" button.



Step 7. Increase the power rating.

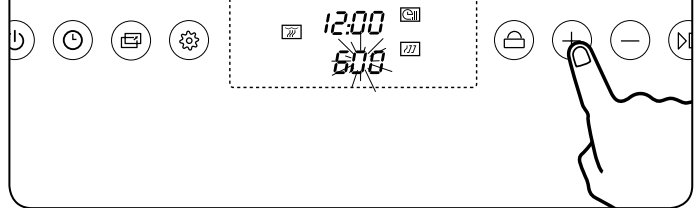

Step 2. Press the + button to choose Microwave Grill.

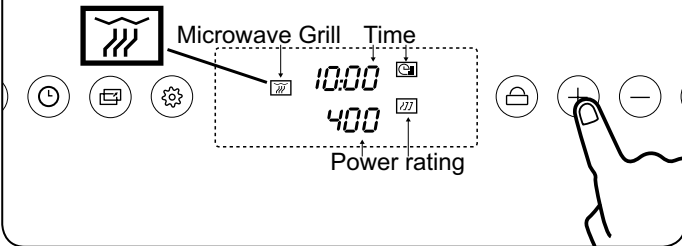

Step 8. Decrease the power rating.

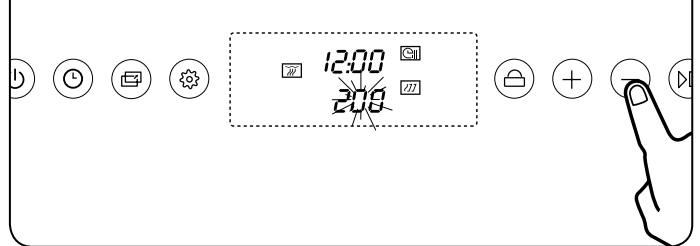

Step 3. Press the "Timer" to set the time.

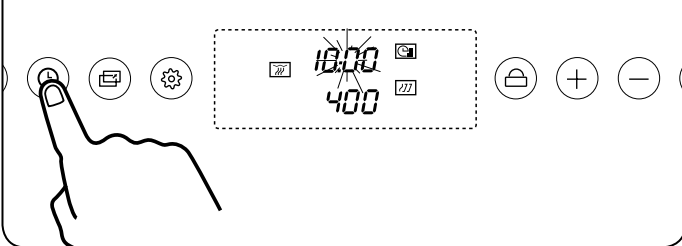

Step 9. After setting the power rating. Press the "Timer" button twice to set the delayed start. The current time will appear.



Step 4. Increments of +30secs.

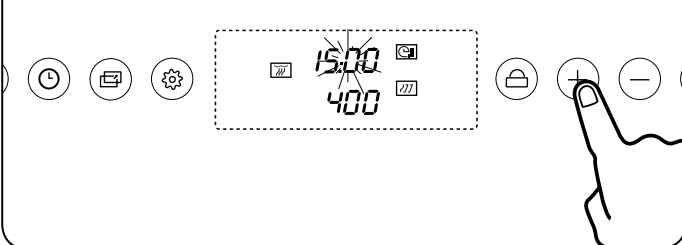

Step 10. Calculate the time to start the Microwave Grill.

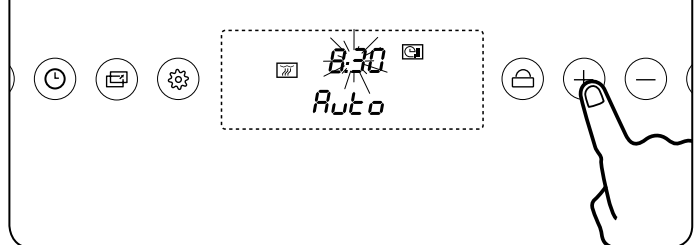

Step 5. Increments of -30secs.

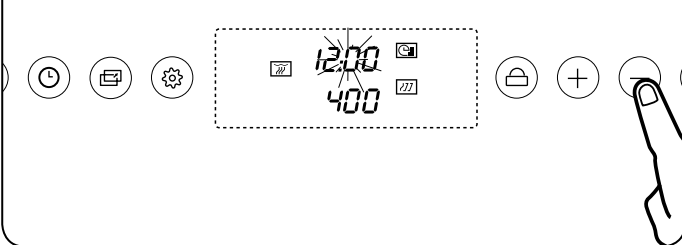

Step 11. Press "start" to confirm start time. Once set, the display will show the function and "AUTO" text.



Step 6. Press the "Function" to change/set the power rating. Refer to **Table 2.2 Microwave Grill ratings**.

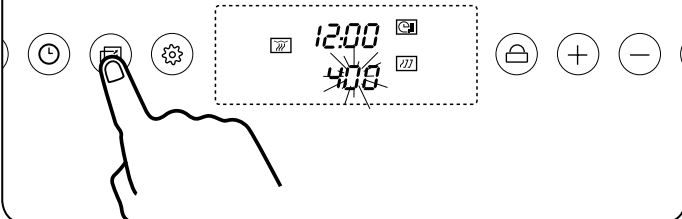

NOTE:

At the end of each cooking process the oven will emit 3 beeps every 30 seconds for five minutes or until the oven door is open or when you press the **Start / Pause**.

Using the Grill Convection

Step 1. Firmly press the "Standby" button.

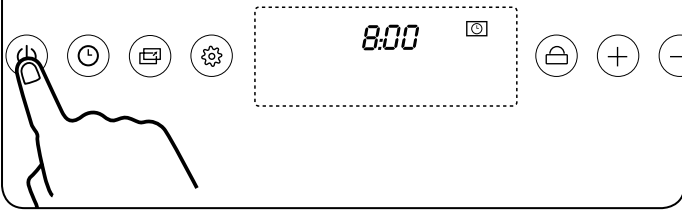

Step 2. Press the + button to choose Grill Convection.

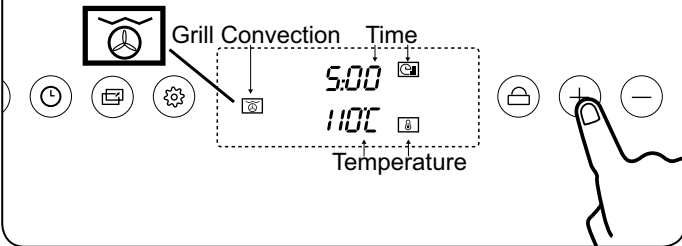

Step 3. Press the "Timer" to set the time.

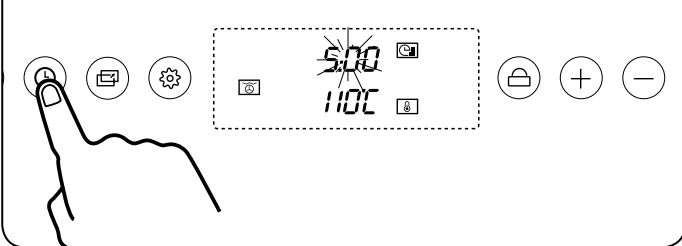

Step 4. Increments of +30secs.

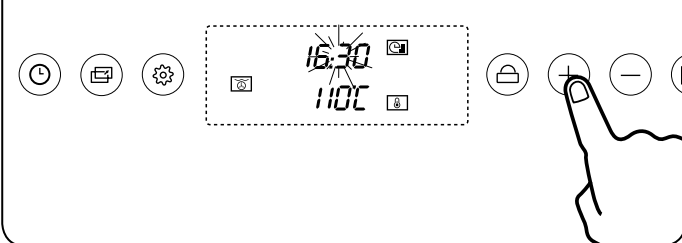

Step 5. Increments of -30secs.

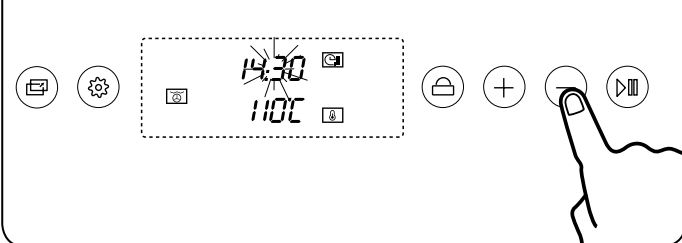

Step 6. Press the "Function" to set the temperature.

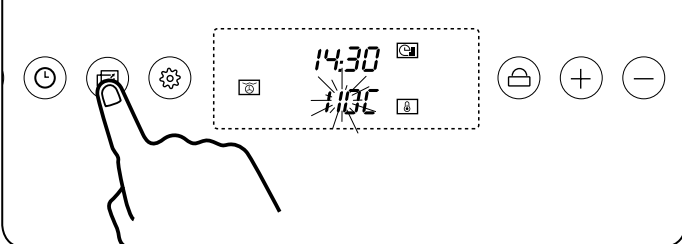

Step 7. Increase temperature.

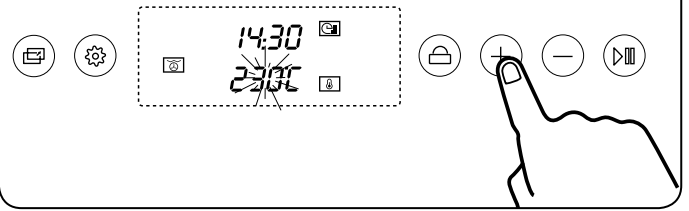

Step 8. Decrease temperature.

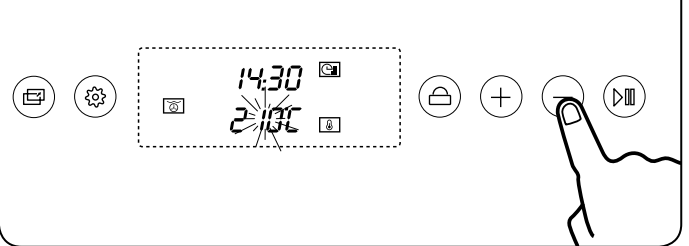

Step 9. Press the "Pause/Start" button to confirm the setting.



Step 10. Press the "childlock" button, to confirm if the Grill Convection has reached your desired temperature.

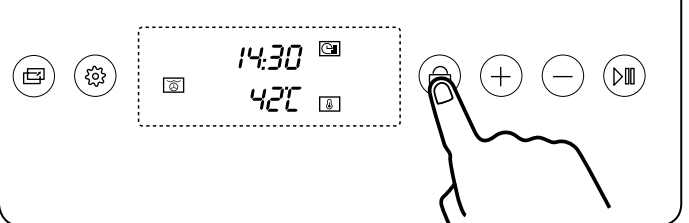

NOTE:

At the end of each cooking process the oven will emit 3 beeps every 30 seconds for five minutes or until the oven door is open or when you press the **Start / Pause**.

Setting the delayed start for the Grill Convection

Step 1. Firmly press the "Standby" button.

Step 2. Press the + button to choose Grill Convection.

Step 3. Press the "Timer" to set the time.

Step 4. Increments of +30secs.

Step 5. Increments of -30secs.

Step 6. Press the "Function" to set the temperature.

Step 7. Increase temperature.

Step 8. Decrease temperature.

Step 8. After setting the temperature. Press the "Timer" button twice to set the delayed start. The current time will appear.

Step 10. Calculate the time to start the Grill Convection..

Step 11. Press "start" to confirm start time. Once set, the display will show the function and "AUTO" text.

NOTE:

At the end of each cooking process the oven will emit 3 beeps every 30 seconds for five minutes or until the oven door is open or when you press the **Start / Pause**.

Using the Microwave Convection

Step 1. Firmly press the "Standby" button.



Step 7. Increase the power rating.

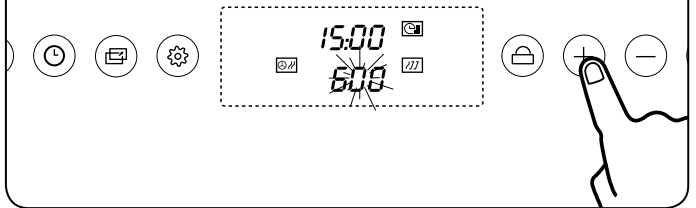

Step 2. Press the + button to choose Microwave Convection.

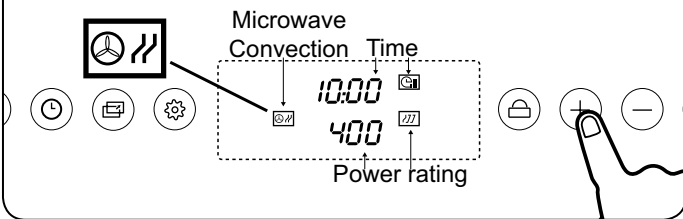

Step 8. Decrease the power rating.

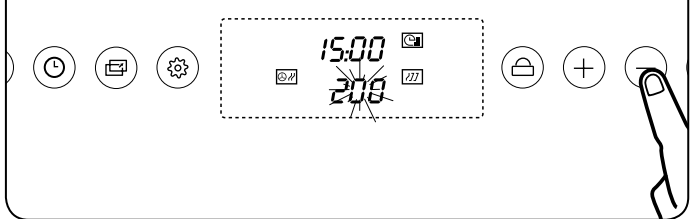

Step 3. Press the "Timer" to set the time.

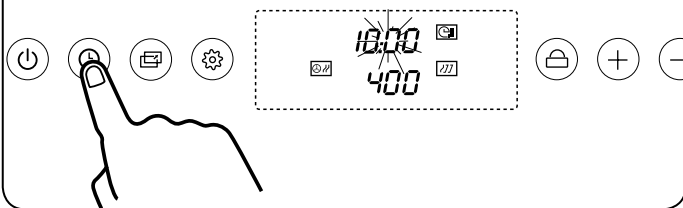

Step 9. Press the "Pause/Start" button to confirm the setting.

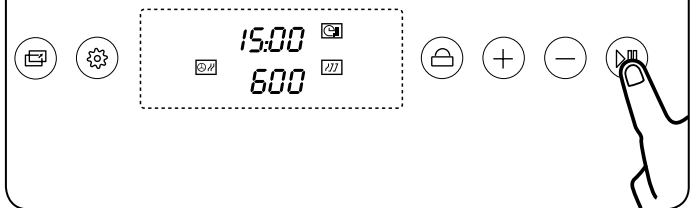

Step 4. Increments of +30secs.

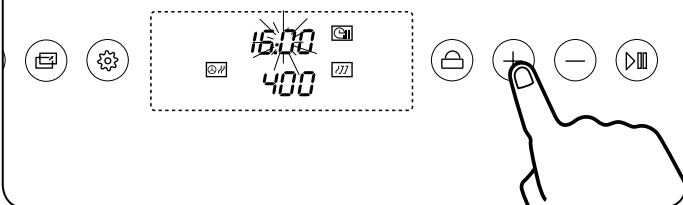

NOTE:

At the end of each cooking process the oven will emit 3 beeps every 30 seconds for five minutes or until the oven door is open or when you press the **Start / Pause**.

Step 5. Increments of -30secs.

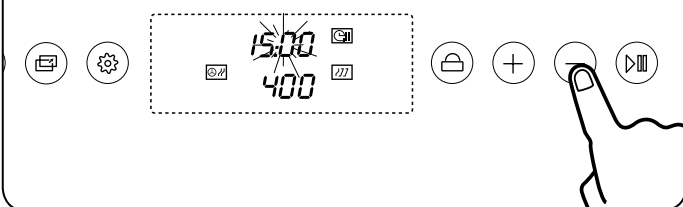

Step 6. Press the "Function" to change/set the power rating.

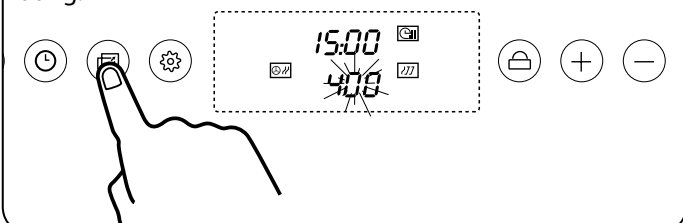

Setting the delayed start for the Microwave Convection

Step 1. Firmly press the "Standby" button.

Step 2. Press the + button to choose Microwave Convection.

Step 3. Press the "Timer" to set the time.

Step 4. Increments of +30secs.

Step 5. Increments of -30secs.

Step 6. Press the "Function" to change/set the power rating.

Step 7. Increase the power rating.

Step 8. Decrease the power rating.

Step 9. After setting the power rating. Press the "Timer" button twice to set the delayed start. The current time will appear.

Step 10. Calculate the time to start the Microwave Convection..

Step 11. Press "start" to confirm start time. Once set, the display will show the function and "AUTO" text.

NOTE:

At the end of each cooking process the oven will emit 3 beeps every 30 seconds for five minutes or until the oven door is open or when you press the **Start / Pause**.

Using the Microwave Grill Convection

Step 1. Firmly press the "Standby" button.

Step 2. Press the + button to choose Microwave Grill Convection.

Step 3. Press the "Timer" to set the time.

Step 4. Increments of +30.

Step 5. Increments of -30.

Step 6. Press the "Function" to change/set the power rating.

Step 7. Increase the power rating.

Step 8. Decrease the power rating.

Step 9. Once set, press start. The power rating will alternated between temprature and power.

NOTE:

At the end of each cooking process the oven will emit 3 beeps every 30 seconds for five minutes or until the oven door is open or when you press the **Start / Pause**.

Setting the delayed start for the Microwave Grill Convection

Step 1. Firmly press the "Standby" button.

Step 2. Press the + button to choose Microwave Grill Convection.

Step 3. Press the "Timer" to set the time.

Step 4. Increments of +30.

Step 5. Increments of -30.

Step 6. Press the "Function" to change/set the power rating.

Step 7. Increase the power rating.

Step 8. Decrease the power rating.

Step 9. After setting the power rating. Press the "Timer" button twice to set the delayed start. The current time will appear.

Step 10. Calculate the time to start the Microwave Convection..

Step 11. Press "start" to confirm start time. Once set, the display will show the function and "AUTO" text.

NOTE:

At the end of each cooking process the oven will emit 3 beeps every 30 seconds for five minutes or until the oven door is open or when you press the **Start / Pause**.

Defrosting with microwaves

- When defrosting, use only dishes that are appropriate for microwaves.
- The defrost function by weight and the tables refer **Table 2.5 page 28**.
- The defrosting time depends on the quantity and thickness of the food. When freezing food keep the defrosting process in mind. Distribute the food evenly in the container.
- Thick portions of food should be turned over several times in the process of baking.
- Distribute the frozen food as evenly as possible since narrow and thick portions defrost more quickly than the thicker and broader parts.
- Fat-rich foods such as butter, cheese and cream should not be completely defrosted. If they are kept at room temperature they will be ready to be served in a few minutes. With ultra-frozen cream, if you find small pieces of ice in it, you should mix these in before serving.
- Place poultry on an upturned plate so that the meat juices can run off more easily.
- Bread should be wrapped in a napkin so that it does not become too dry.
- Remove frozen food from its wrapping and do not forget to take off any metal twist-tags. For containers that are used to keep frozen food in the freezer and which can also be used for heating and cooking, all you need to do is take off the lid. For all other cases you should put the food into containers that are suitable for microwave use.
- The liquid resulting from defrosting, principally that from poultry, should be discarded. In no event should such liquids be allowed to come into contact with other foods.
- Do not forget that by using the defrosting function you need to allow for standing time until the food is completely defrosted.
- In defrost process, please turn food over when microwave oven alarm sounds and the display says "turn".

Using the Defrost

Half way through the defrost process, the appliance will stop and emit 3 beeps every 30 seconds. The defrost icon will become static and the word "turn" will appear. Open the door, turn the food over and press the **Start / Pause** button to continue defrosting.

Step 1. Firmly press the "Standby" button.

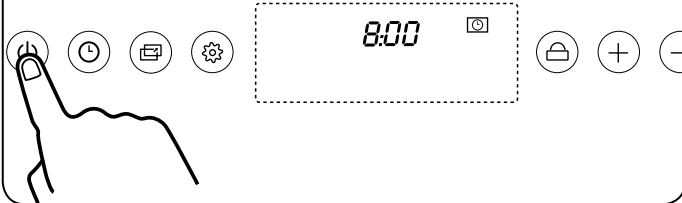

Step 5. Increase the weight.

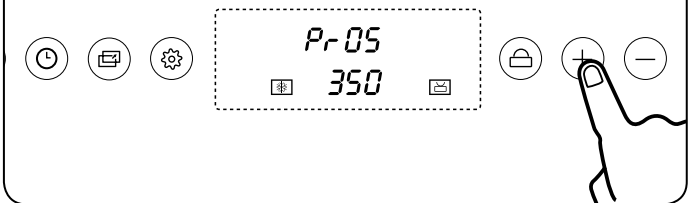

Step 2. Press the + button to choose Defrost

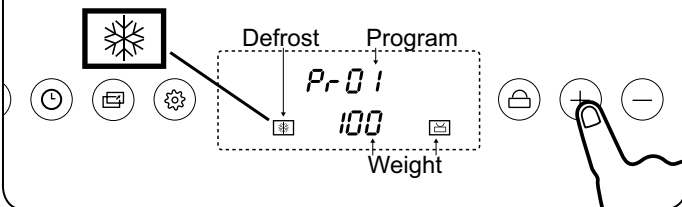

Step 6. Decrease the weight.

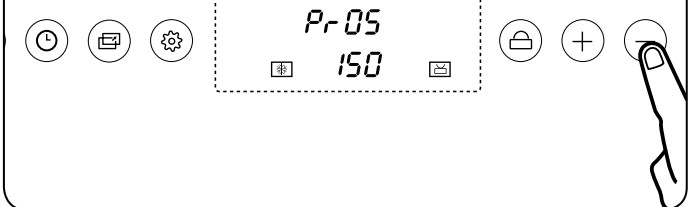

Step 3. Choose a program.
Refer to **Table 2.3 Defrost ratings.**

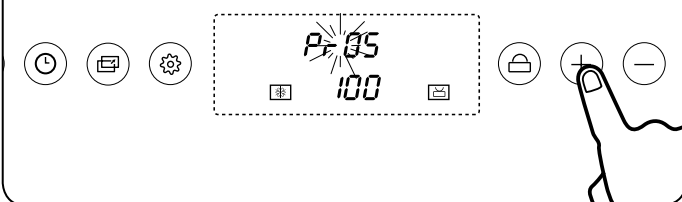

Step 7. Press the "Pause/Start" button to confirm the setting.

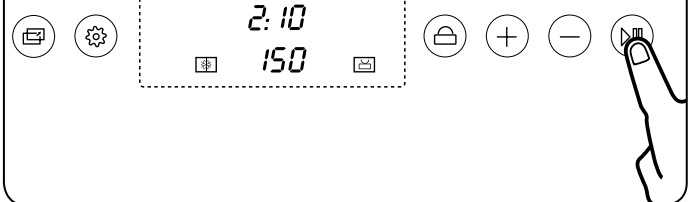

Step 4. Press the "Function" to change/set the weight.

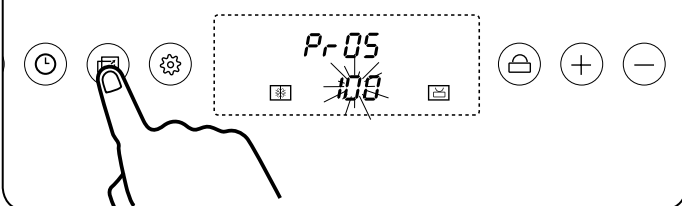

NOTE:

At the end of each cooking process the oven will emit 3 beeps every 30 seconds for five minutes or until the oven door is open or when you press the **Start / Pause**.

Setting the delayed start for Defrost

Step 1. Firmly press the "Standby" button.



Step 6. Decrease the weight.

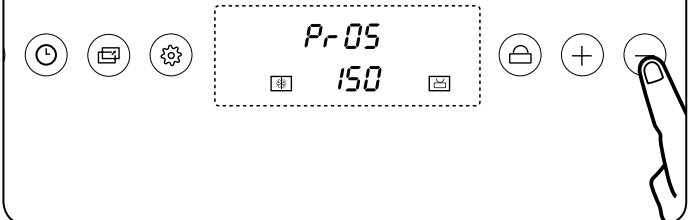

Step 2. Press the + button to choose Defrost

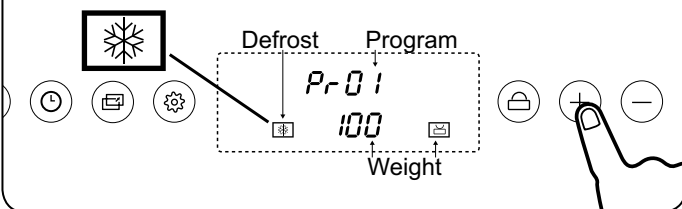

Step 7. After setting the weight. Press the "Timer" button twice to set the delayed start. The current time will appear.



Step 3. Choose a program.
Refer to **Table 2.3 Defrost ratings.**

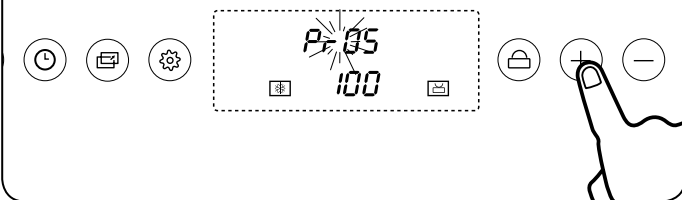

Step 8. Calculate the time to start the Defrost



Step 4. Press the "Function" to change/set the weight.

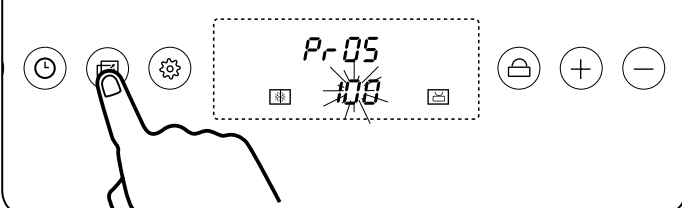

Step 9. Press "start" to confirm start time. Once set, the display will show the function and "AUTO" text.



Step 5. Increase the weight.

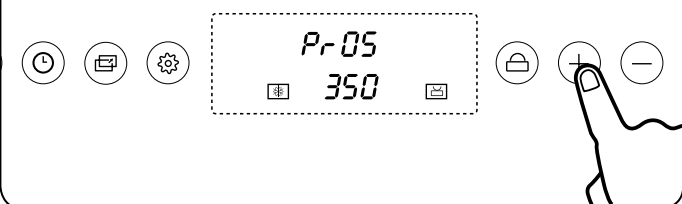

NOTE:

At the end of each cooking process the oven will emit 3 beeps every 30 seconds for five minutes or until the oven door is open or when you press the **Start / Pause**.

Pause during cooking

Press the "Pause/Start" button.

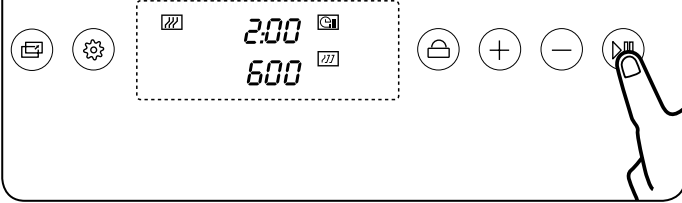

Cancel cooking

To cancel the cooking process, press the "Standby" button until you hear the beep to confirm cancellation.

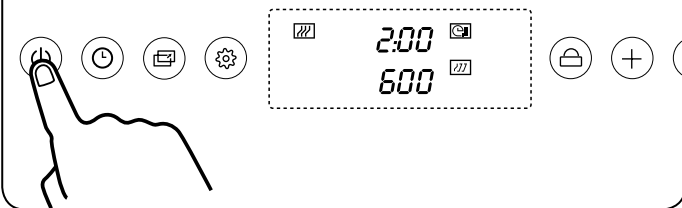

Child Lock

Press "Child Lock" for 3 seconds. A beep will sound to confirm child lock is active and the icon will appear. Repeat to unlock.

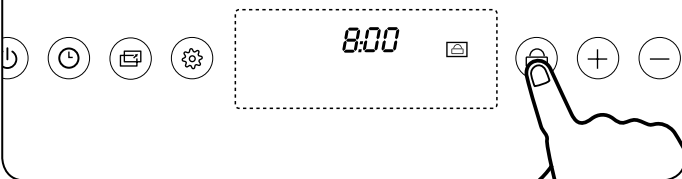

Modifying Parameters

The parameters of weight, time and temperature can only be modified when the cooking has been stopped.

If you need to change the cooking duration, press the "Timer" to change the time.

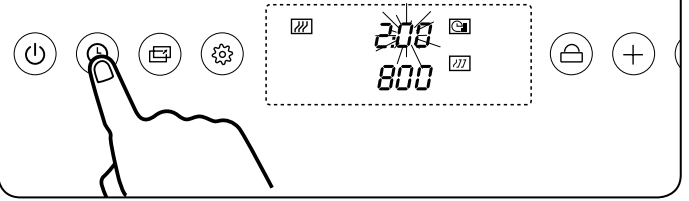

If you need to change either the weight or temperature, press the "Function" to change the time.

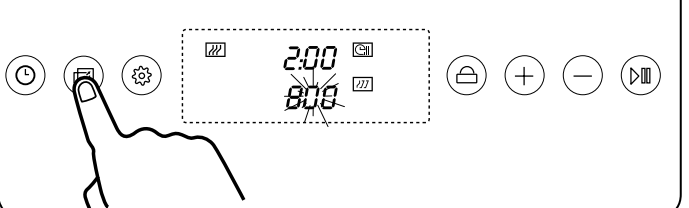

Cooling Fan

The appliance is equipped with a cooling fan which comes into operation as soon as a cooking function starts.

Operation of the fan generates a normal airflow which comes out above the door and may continue for a short time even after the appliance is switched off.

Door Interlock Switch

If you try to start the oven when the door is open the light will come on and the screen will display "door". The screen will return to the original display after 3 seconds.

The light comes on when in use and when the oven door is open in "Standby" mode. If the oven door is open longer than 10 minutes the light will switch off after 10 minutes.

Cleaning and Maintenance

Before carrying out any operations, disconnect the appliance from the electricity supply. Take the plug out of the socket or switch of the oven's power circuit.

⚠ Never use a jet of steam for cleaning the inside of the oven.

⚠ The microwave oven should be cleaned regularly, with all food remains being removed. The surface of microwave may deteriorate if it is not clean. That may reduce the oven's working life and possibly result in a dangerous situation.

Cleaning Stainless Steel

To keep stainless steel in a good condition, it should be cleaned regularly.

Daily Cleaning Routine

When cleaning and caring for stainless steel surfaces, always use only specific products which do not contain abrasives or chlorine-based acids.

Instructions for use: Pour the product onto a damp cloth and wipe over the surface, then rinse thoroughly and dry with a soft cloth or chamois leather.

Food Stains Or Spills

Never use metal scouring pads or sharp scrapers which may damage the surface of the oven.

Use ordinary non-abrasive products with the aid of wooden or plastic utensils if necessary. Rinse thoroughly and dry with a soft cloth or chamois leather.

Cleaning The Oven Cavity

Cleaning is the only maintenance normally required. Every time after cooking, clean the inner cavity with a damp cloth since this is an easier way to remove splashes or spots that may stick to the cavity.

To remove dirt that is harder to shift, use a non-aggressive cleaning product. Do not use oven sprays or other aggressive or abrasive cleaning products.

Always keep the door and the oven front very clean to ensure that the door opens and closes properly.

Make sure water does not permeate into the microwave ventilation holes.

Regularly take out the turntable plate and the respective support and clean the cavity base, especially after any liquid spillage.

Microwave should not work without turntable.

If the oven cavity is very dirty, put a glass of water on the turntable and switch on the microwave oven for 2 or 3 minutes at maximum power. The steam released will soften the dirt which can then be cleaned easily using a soft cloth. Unpleasant odors (e.g. after cooking fish) can be eliminated easily. Put a few drops of lemon juice in a cup with water. Put a spoonful of coffee in the cup to avoid the water boiling over. Heat the water for 2 to 3 minutes at maximum microwave power.

Cleaning The Cavity Ceiling

If the oven ceiling is dirty, to avoid the danger of burning, wait until the grill is cold before lowering it.

DO NOT use abrasive cleaning products or sharp objects.

To avoid any risk, do not remove the mica cover.

The glass lamp cover is located on the oven ceiling and can be removed easily for cleaning. For this you just need to unscrew it and clean it with water and dishwashing liquid.

Rinse Of Door Seal And Front Panel

Please rinse in time if there are residues left in door seal or on front panel. Do not use rough cleaning tools like hard brush, coarse cloth, wire netting, knife or any other sharp tools, using those sharp tools may scratch door seal or the surface of the front panel. Please use non-abrasive detergent. You can use wooden or plastic cleaning tools if it is necessary.

Cleaning The Accessories

Clean the accessories after each use. If they are very dirty, soak them first of all and then use a brush and sponge. The accessories can be washed in a dish washing machine.

Make sure that the turntable plate and the respective support are always clean. Do not switch on the oven unless the turntable and the respective support are in place.

Troubleshooting

Replacing The Light Bulb Fig. 2.3

1. Take off the plug from power supply.
2. Take off the lampshade
3. Take down halogen lamp Warning: Hot lamp!
4. Fill new halogen lamp (230V-25W).
5. Operate according to the instruction.
6. Install lampshade well.
7. Connect the power.

⚠ The lamp is not suggested for consumer to replace. The replacing should be done by a professional mechanic.

Fig. 2.3

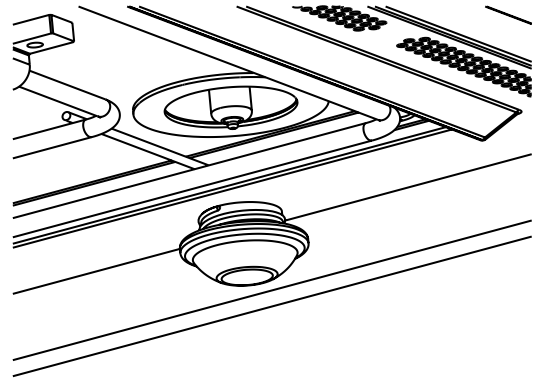

The control settings and cooking times given in the tables are intended to be used **AS A GUIDE ONLY**. Individual tastes may require the temperature to be altered to provide a preferred result.

Display	1000W	800W	600W	400W	200W	0W
Power	High	Medium High	Medium	Medium Low	Low	Cool

Table 2.1 Microwave rating

Food	Quantity (g)	Dish	Power (W)	Time (min)	Standing time (min)
Cheese topped pasta	500	Low dish	400	12-17	3-5
Cheese topped potatoes	800	Low dish	600	20-22	3-5
Lasange	Approx 800	Low dish	600	15-20	3-5
Grilled Cream Cheese	Approx 500	Low dish	400	18-20	3-5
2 Fresh Chicken legs (Grilled)	200 Each	Low dish	400	10-15	3-5
Chicken	Approx 1000	Low land wide fish	400	35-40	3-5
Cheese topped onion soup	2x 200 cups	Soup bowls	400	2-4	3-5

Table 2.2 Microwave Grill ratings

Program	Food	Weight (g)	Time (min)	Duration (min)
PR 01	Meat	100 - 2000	2:20-43:30	20 - 30
PR 02	Poultry	100 - 2500	2:10-58:10	20 - 30
PR 03	Fish	100 - 2000	2:00-40:00	20 - 30
PR 04	Fruit	100 - 500	2:36-13:00	10 - 20
PR 05	Bread	100 - 800	2:25-19:20	10 - 20

Table 2.3 Defrost ratings

Name	Weight (g)	Water	Fire Power	Time (min)	Follow up Time (min)	Notice
Cauliflower	500	100	800	9-11	2-3	Cut into slices Cover well
Broccoli	300	50	800	6-8	2-3	
Mushroom	250	25	800	7-9	2-3	
Peas, carrots / frozen carrots	300 / 250	100 / 25	800	8-10	2-3	Cut into slices or blocks, cover well
Potatoes	250	25	800	5-7	2-3	Peel and cut into uniform size, cover well
Chives	250	25	800	5-7	2-3	Cut into segments or slices, cover well
Frozen cabbage	300	50	800	6-8	2-3	Cover well

Table 2.4 Vegetables

Name of food	Weight (g)	Defrosting (min)	Follow up Time (min)	Frequency of turnover
Meat (veal, beef, pork)	100	2-3	5-10	1
	200	4-5	5-10	1
	500	10-12	10-15	2
	1000	21-23	20-30	2
	1500	32-34	20-30	2
	2000	43-45	25-35	3
Beef stew	500	8-10	10-15	2
	1000	17-19	20-30	3
Minced meat	100	2-4	10-15	2
	500	10-14	20-30	3
Sausage	200	4-6	10-15	2
	500	9-12	15-20	3
Poultry	250	5-6	5-10	1
Chicken	1000	20-24	20-30	2
Dorking	2500	38-42	25-35	3
Fish fillet	200	4-5	5-10	1
Trout Prawn	250	5-6	5-10	1
	100	2-3	5-10	1
	500	8-11	15-20	2
Fruit	200	4-5	5-10	1
	300	8-9	5-10	1
	500	11-14	10-20	2
Bread	200	4-5	5-10	1
	500	10-12	10-15	1
	800	15-17	10-20	2
Butter	250	8-10	10-15	
Cheese	250	6-8	10-15	
Cream	250	7-8	10-15	

Table 2.5 Defrosting with microwaves

Name	Quantity (g)	Time (min)	Instructions
Fish			
Bass	800	18-24	Spread lightly with butter. After half of cooking time turn and spread with seasoning.
Sardines/gurnard	6-8 Fish	15-20	
Meat			
Sausages	6-8 Units	22-26	Prick after half cooking time and turn
Frozen hamburgers	3 Units	18-20	
Spare rib (approx.3 Cm thick)	400	25-30	After half of cooking time, baste and turn
Toast	4 Units	3/2-3	Watch toasting
Toasted sandwiches	2 Units	5-10	Watch toasting

Table 2.6 Cooking with Grill

INSTALLATION

Check the appliance is electrically safe and gas sound when you have finished.

3. Installation

Dear Installer

Before you start your installation, please complete the details below.

Installer's Name
Installer's Company
Installer's Telephone Number
Appliance Serial Number

If your customer has a problem relating to your installation they will be able to contact you easily.

You must be aware of the following safety requirements & regulations:

This appliance shall be installed in accordance with the regulations in force and in a well-ventilated space. Read the instructions before installing or using this appliance.

The cooker must be installed in accordance with:

- All relevant British Standards / Codes of Practice
- The relevant Building / IET regulations

Before The Installation

Open the oven door and take out all the accessories and remove the packing material.

Make sure that the oven is not damaged by any way. Check that the oven door closes correctly and the inside of the door and front oven panel are not damaged.

Do not use the oven if the power cable or the plug is damaged, if the oven does not function correctly or if it has been damaged or dropped. Put the oven on a flat and stable surface. The oven should not be installed close to any heat source, radios or televisions.

During installation, make sure that the power cable does not come into contact with any moisture or objects with sharp edges and the back of the oven. High temperature can damage the cable. Warning: after the oven is installed you should make sure you can access the plug.

Location of the Oven

The oven may be installed in a kitchen/kitchen diner but NOT in a room containing a bath or shower.

This appliance is designed for domestic cooking only. Use for any other purpose could invalidate any warranty or liability claim.

⚠ This appliance should not be installed in a boat or caravan.

The hob must be installed in accordance with the relevant Building regulations and IET regulations.

You will need the following tools and equipment to complete the oven installation satisfactorily:

1. Electric drill
2. Steel tape measure
3. Cross head screwdriver
4. Pencil
5. Multimeter (for electrical checks)

INSTALLATION

Check the appliance is electrically safe and gas sound when you have finished.

Fig. 3.1

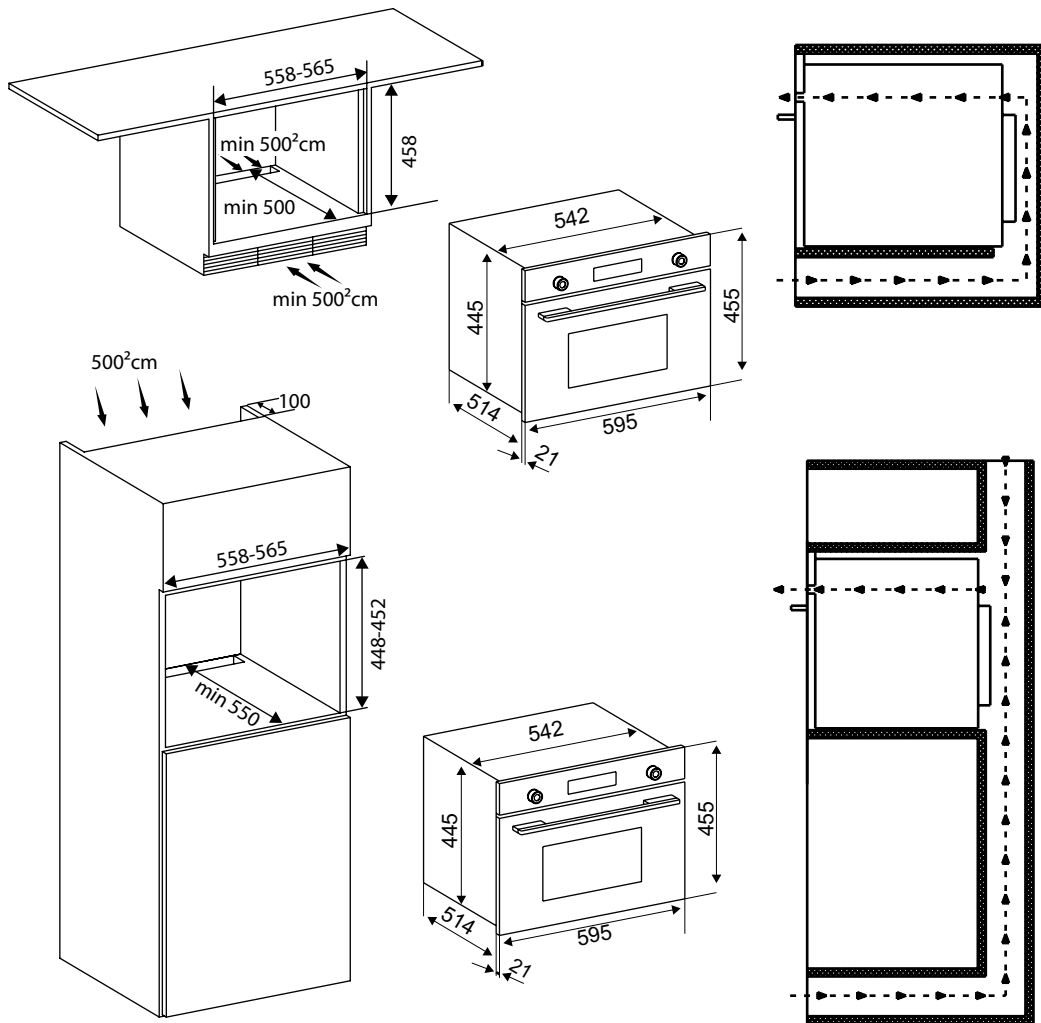

All dimensions in mm unless otherwise shown

INSTALLATION

Check the appliance is electrically safe and gas sound when you have finished.

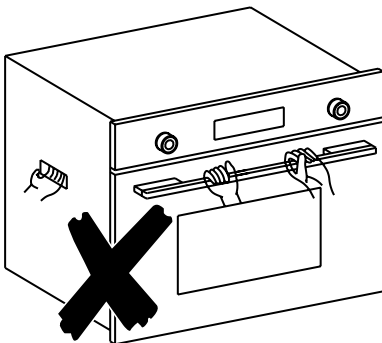
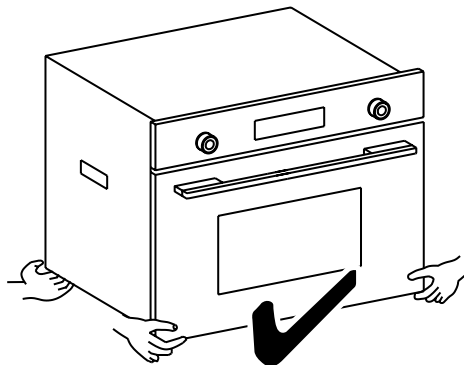
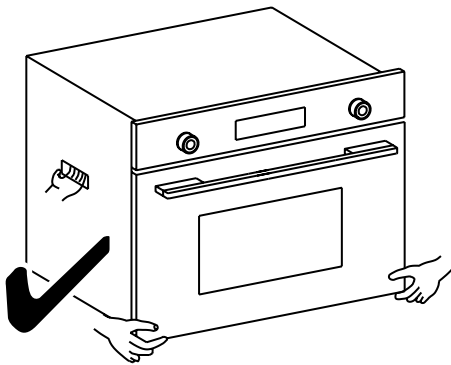
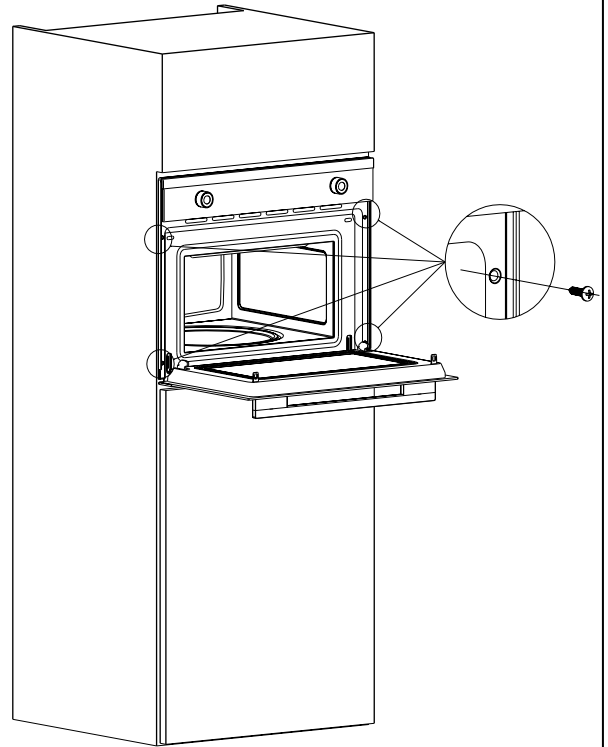
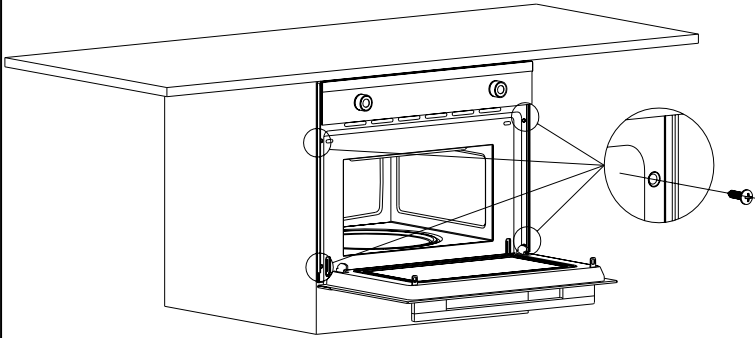

▲ DO NOT use the handle to lift the oven

INSTALLATION

Check the appliance is electrically safe and gas sound when you have finished.

Electrical Connection

This appliance must be installed by a qualified electrician to comply with the relevant Institution of Engineering and Technology (I.E.T.) regulations and also the local electricity supply company requirements.

⚠ WARNING: THIS APPLIANCE MUST BE EARTHED

This appliance must be connected by a competent person, using fixed wiring via a double pole switched fused spur outlet, protected by a 13A fuse (Fig. 3.2).

We recommend that the appliance is connected by a qualified electrician, who is a member of the N.I.C.E.I.C. and who will comply with the I.E.T. and local regulations. The wires in the mains lead are coloured in accordance with the following code:

⚠ This appliance must not be connected to an ordinary domestic power point.

The mains terminal is situated on the back of the oven (Fig. 3.3).

- GREEN AND YELLOW = EARTH
- BLUE = NEUTRAL
- BROWN = LIVE.

As the colours of the wires in the mains lead for the appliance may not correspond with the coloured markings identifying the terminals in your spur box, proceed as follows:

1. The wire which is coloured green and yellow must be connected to the terminal marked E (Earth) or coloured Green.
2. The wire which is coloured blue must be connected to the terminal marked N (Neutral) or coloured Black.
3. The wire which is coloured brown must be connected to the terminal marked L (Live) or coloured Red.

Connect the cable to the correct terminals. Check that the links are correctly fitted and that the terminal screws are tight. Secure the mains cable using the cable clamp.

Ensure the cable route avoids the risk of trapping or touching hot surfaces.

Current Operated Earth Leakage Breakers

Where the installation is protected by a 30mA sensitivity residual current device (RCD), the combined use of your appliance and other domestic appliances may occasionally cause nuisance tripping. In these instances the kitchen circuit may need to be reconfigured. This work should be carried out by a qualified electrician.

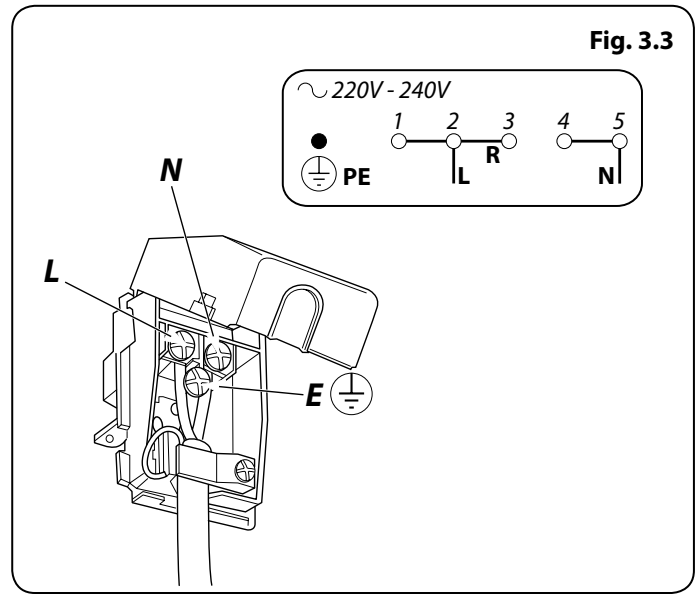
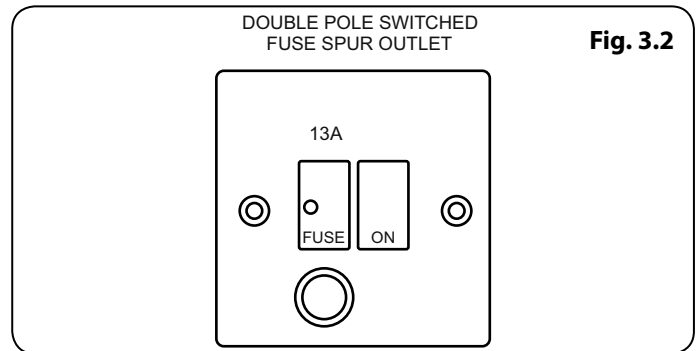

4. Circuit Diagram

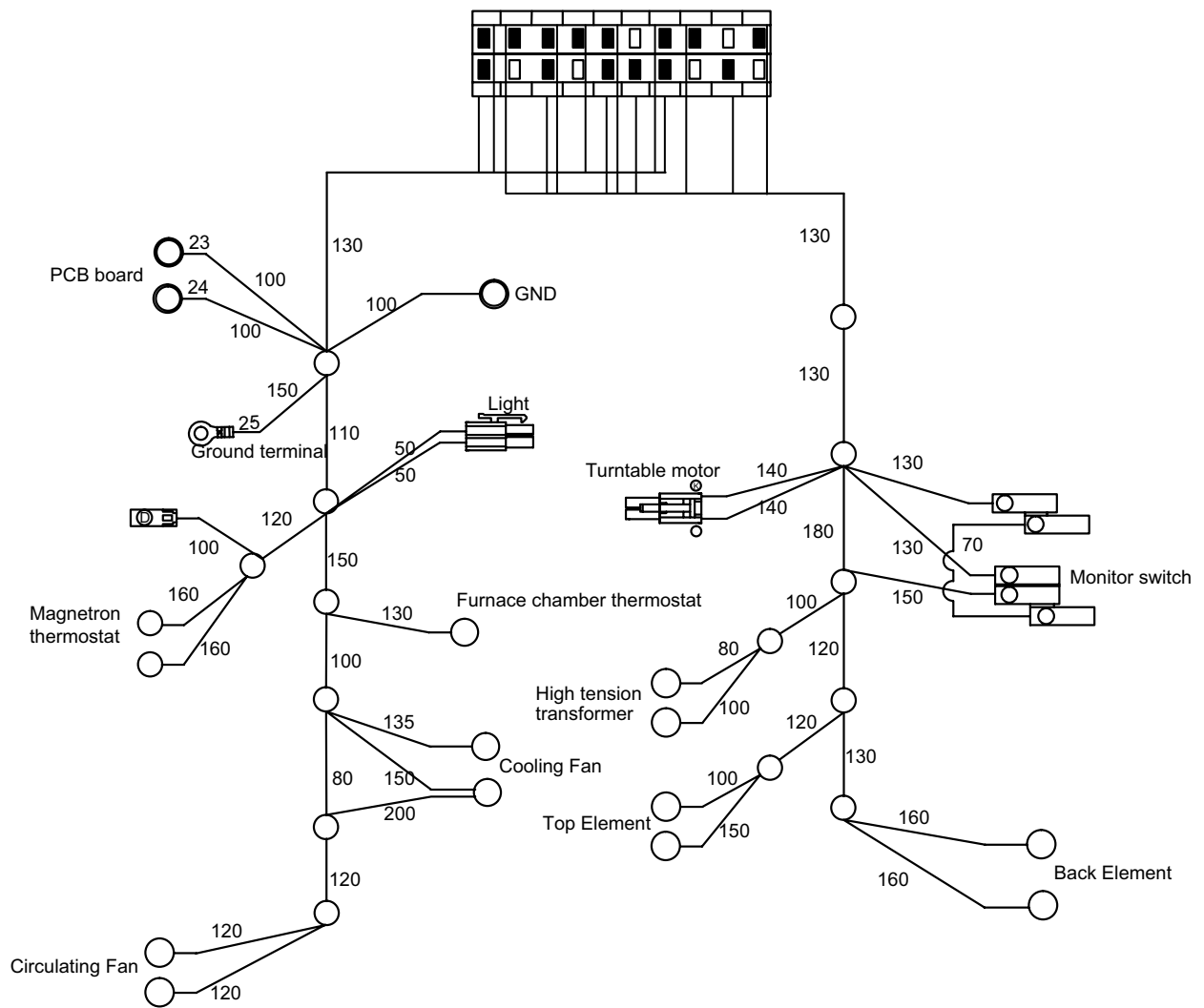

5. Technical Data

INSTALLER: Please leave these instructions with the user.

DATA BADGE LOCATION: Back of the drawer.

COUNTRY OF DESTINATION: GB, IE.

Dimensions

Dimensions	Oven (excluding front frame)	Oven (including front frame)
Height	445 mm	455 mm
Width	544 mm	595 mm
Depth	514 mm	535 mm
Mass (kg)	36	

Data

Brand	Rangemaster	
Model identification	RMB45MCBL/SS	
Type of drawer		Electric
Number of cavities		1
Volume	Litres	35
Max load	kg	38.0

Maximum total electrical load at 230 V (approximate total including, oven lights, power steam/oven etc.)	1.400 kW
-----------------------------------------------------------------------------------------------------------------	----------

6. Warranty/After Sales Service

If consultation or technical assistance is needed, please provide the local authorised service agent with the purchase invoice and the product code/serial number.

The 2 years free maintenance for the operation of the appliance started from the date of purchase of this product.

Any cosmetic damage to the appliance must be reported within 90 days of delivery.

Free from a landline: +44 (0) 800 8046261

Depending on your mobile network, call from this number is free: +44 (0) 3707 895107

Notes

AGA RANGEmaster

Clarence Street, Royal Leamington Spa,
Warwickshire, CV31 2AD, England.

Tel: +44 (0) 800 8046261

E-mail: consumers@agarangemaster.co.uk

