



**SPEAR &
JACKSON**

ORIGINAL INSTRUCTION MANUAL

450W

Electric Hedge Trimmer

HTEG48A-450



**Important - Please read these instructions
fully before starting assembly**

These instructions contain important information that will help you get the best from your trimmer, ensuring it is assembled correctly and safely. If you need help or have damaged or missing parts, call the Customer Helpline on 0345 605 2067

**AFTER SALES SUPPORT
0345 605 2067**

SPEAR & JACKSON SINCE 1760

For more than 250 years gardeners have enjoyed high quality performance and great results using Spear & Jackson tools.

Our garden power tools combine continuous innovation and the latest in manufacturing technologies with a proud heritage.

Each product is carefully designed with performance, comfort and durability firmly in mind, which has earned Spear & Jackson an enviable reputation as a maker of tools to trust.

3 YEARS GUARANTEE

As a testament to the quality of our products, we offer a 3 year manufacturers warranty and a comprehensive after sales service.

The warranty covers manufacturing faults, however in the event that the item has been deliberately damaged, used in a commercial environment or disassembled then the warranty will be null and void.

Please retain proof of purchase.

7 DAYS A WEEK TECHNICAL SUPPORT

We want you to get the best out of your products. Our easy-to-read instruction manual guides you with best practice use and maintenance tips. Please call **0345 605 2067** for technical support, we can solve around 80% of questions directly over the phone.

We hope you enjoy your product and we look forward to any feedback, as this allows us to develop even better products for the future.

CONTENTS

Safety Information	04
Description of symbols	04
General safety	05
Personal safety	07
Operational safety	08
Maintenance and storage safety	10
Intended use	11
In The Box	12
Assemble	12
Unpacking.....	13
Blade sheath	13
Connection to the power supply	14
Operate	15
General operate.....	15
Remove the blade sheath	15
Switching on/off	16
Trimming times	16
Trimming	16
Maintenance	18
General cleaning	18
Cleaning the blades	19
Repair	19
Storage	20
Transportation	20
Recycling and disposal	20
Technical Data	21
Troubleshooting	22
Warranty	23

SAFETY INFORMATION

Please read these instructions fully before operating or maintaining your machine

DESCRIPTION OF SYMBOLS

The following warning symbols appear throughout this manual and indicate the appropriate safety measures you should take when operating and maintaining the hedge trimmer.



IMPORTANT!

Please read all of the safety and operating instructions carefully before using this tool.



WARNING!

This is a warning symbol. This symbol is used throughout the user guide whenever there is a risk of personal injury. Ensure that these warnings are read and understood at all times.



Wear ear protection



Wear eye protection



Wear protect mask



Wear proper safety shoes.



Disconnect the mains plug immediately if the cable is damaged, has been badly twisted or is completely cut through and in the event that the device is left unattended for a short time.



Objects thrown by the product could hit the user or other bystanders. Always ensure that other people and pets remain at a safe distance from the product when it is in operation. In general, children must not come near the area where the product is.



Warning! Switch the product off and disconnect it from the power supply before assembly, cleaning, adjustments, maintenance, storage and transportation.



Guaranteed sound power level.



Keep fingers away from moving blades.



Do not expose the product to rain or wet conditions (moisture).



Double insulations, Class II appliance.



Waste Disposal and Environmental Protection!

Be environmentally friendly. Return the tool, accessories and packaging to a recycling centre when you have finished with them.

Electrical machines do not belong in domestic waste.

Take the equipment to a waste disposal site. The plastic and metal parts that are used can be separated out into pure grade, which allows recycling.

SAFETY INFORMATION

Please read these instructions fully before operating or maintaining your machine

GENERAL SAFETY



IMPORTANT!

- Keep this instruction manual in a safe place for future reference.
- Read the instructions carefully. Be familiar with the controls and the proper use of the equipment.
- Never allow children or people unfamiliar with these instructions to use the hedge trimmer. Local regulations can restrict the age of the operator.
- Never use the machine while people, especially children, or pets are nearby. Keep in mind that the operator or user is responsible for accidents or hazards occurring to other people or their property.
- This appliance is not intended for use by persons (including children) with reduced

physical, sensory or mental capabilities, or lack of experience and knowledge, unless they have been given supervision or instruction concerning use of the appliance by a person responsible for their safety.

- Don't use the appliance without reading the instruction manual.
- Children should be supervised to ensure that they do not play with the appliance.

Work area safety

- Keep the work area clean and well lit. Cluttered or dark areas invite accidents.
- Do not operate power tools in explosive atmospheres, such as in the presence of flammable liquids, gases or dust. Power tools create sparks which may ignite the dust or fumes.

SAFETY INFORMATION

Please read these instructions fully before operating or maintaining your machine

- Keep children and bystanders away while operating a power tool. Distractions can cause you to lose control.

Electrical safety

- Power tool plugs must match the outlet. Never modify the plug in any way. Do not use any adapter plugs with earthed (grounded) power tools. Unmodified plugs and matching outlets will reduce the risk of electric shock.
- Avoid body contact with earthed or grounded surfaces, such as pipes, radiators, ranges and refrigerators. There is an increased risk of electric shock if your body is earthed or grounded.
- Do not expose power tools to rain or wet conditions. Water entering a power tool will increase the risk of electric shock.
- Do not abuse the cord. Never use the cord for carrying, pulling or unplugging the power tool. Keep the cord away from heat, oil, sharp edges or moving parts. Damaged or entangled cords increase the risk of electric shock.
- When operating a power tool outdoors, use an extension cord suitable for outdoor use. Use of a cord suitable for outdoor use reduces the risk of electric shock.
- If operating a power tool in a damp location is unavoidable, use a residual current device (RCD) protected supply. Use of an RCD reduces the risk of electric shock. The maximum operating current of the RCD must be less than 30mA.

Power tool use and care

- Do not force the power tool. Use the correct power tool for your application.

SAFETY INFORMATION

Please read these instructions fully before operating or maintaining your machine

The correct power tool will do the job better and more safely when operated at the rate for which it was designed.

- Do not use the power tool if the switch does not turn it on and off. Any power tool that cannot be controlled with the switch is dangerous and must be repaired.
- Disconnect the plug from the power source and/ or the battery pack from the power tool before making any adjustments, changing accessories, or storing power tools. Such preventive safety measures reduce the risk of starting the power tool accidentally.
- Store idle power tools out of the reach of children and do not allow persons unfamiliar with the power tool or these instructions to operate the power tool. Power tools are dangerous in the hands of untrained users.

PERSONAL SAFETY

- Stay alert, watch what you are doing and use common sense when operating a power tool. Do not use a power tool while you are tired or under the influence of drugs, alcohol or medication. A moment of inattention while operating power tools may result in serious personal injury.
- Use personal protective equipment. Always wear eye protection. Protective equipment such as dust mask, non-skid safety shoes, hard hat, or hearing protection used for appropriate conditions will reduce the risk of personal injuries.
- Prevent unintentional starting. Ensure the switch is in the off-position before connecting to the power source and/or battery pack, picking up or carrying the tool. Carrying

SAFETY INFORMATION

Please read these instructions fully before operating or maintaining your machine

power tools with your finger on the switch or energising power tools that have the switch on invites accidents.

- Remove any adjusting key or wrench before turning the power tool on. A wrench or a key left attached to a rotating part of the power tool may result in personal injury.
- Do not overreach. Keep proper footing and balance at all times. This enables better control of the power tool in unexpected situations.
- Dress properly. Do not wear loose clothing or jewellery. Keep your hair, clothing and gloves away from moving parts. Loose clothes, jewellery or long hair can be caught in moving parts.
- If devices are provided for the connection of dust extraction and collection facilities, ensure these are connected and properly used. Use of dust

collection can reduce dust-related hazards.

OPERATIONAL SAFETY

Training

- Read the instructions carefully. Be familiar with the controls and the proper use of the product.
- Never allow people unfamiliar with these instructions or children to use the product. Local regulations can restrict the age of the operator.
- Keep in mind that the operator or user is responsible for accidents or hazards occurring to other people or their property.

Operation

- Use the product only in daylight or good artificial light.
- Never operate the product with damaged guards or shields or without guards or

SAFETY INFORMATION

Please read these instructions fully before operating or maintaining your machine

shields in place.

- Keep hands and feet away from the cutting attachment at all times and especially when switching on the motor.
- Before use check the controls and correct operation of the product.
- Before using the product or after any impact, check for signs of wear or damage and repair as necessary.
- Always disconnect the product from the power supply (i.e. remove the plug from the power supply or the battery pack):
 - whenever leaving the product unattended;
 - before clearing a blockage;
 - before checking, cleaning or working on the product
 - after striking a foreign object;
 - whenever the product starts vibrating abnormally.
- Take care against injury to feet and hands from the cutting attachment.
- Always ensure that the air vents are kept clear of debris.
- Never use replacement parts or accessories not provided or recommended by the manufacturer.
- The product should be supplied via a residual current device (RCD) with a tripping current of not more than 30 mA.
- Avoid using the product in bad weather conditions especially when there is a risk of lightning.
- Position the cord so that it will not be caught by the cutting attachment during operation.
- Disconnect from the power supply when the cord becomes damaged or tangled.
- If the cord becomes damaged during use, disconnect the cord from the supply immediately. DO

SAFETY INFORMATION

Please read these instructions fully before operating or maintaining your machine

NOT TOUCH THE CORD BEFORE DISCONNECTING THE SUPPLY.

- Do not use the product if the cord is damaged or worn.
- Warning! The cutting elements continue to move after the product is switched off.
- Keep the extension cord away from the blades at all times.
- Only use an extension cord with conductors of not less than 1.5mm² or 2.0mm² and:
 - If rubber insulated, ordinary tough rubber sheathed flexible cord (code designation 60245 IEC 53);
 - If polyvinyl chloride insulated, ordinary polyvinyl chloride sheathed flexible cord (code designation 60227 IEC 53).
- Do not expose the product to rain. instructions is

considered unauthorized use and relieves the manufacturer from his or her legal liability.

MAINTENANCE AND STORAGE SAFETY

- Disconnect the product from the power supply (i.e. remove the plug from the power supply or the battery pack) and check for damage after use.
- Disconnect the product from the power supply (i.e. remove the plug from the power supply or the battery pack) before carrying out maintenance or cleaning work.
- Use only the manufacturer's recommended replacement parts and accessories.
- Inspect and maintain the product regularly. Have the product repaired only by an authorised service centre or similar qualified specialist.
- When not in use, store the

SAFETY INFORMATION

Please read these instructions fully before operating or maintaining your machine

product out of the reach of children.

- Maintain power tools. Check for misalignment or binding of moving parts, breakage of parts and any other condition that may affect the power tool's operation. If damaged, have the power tool repaired before use. Many accidents are caused by poorly maintained power tools.
- Keep cutting tools sharp and clean. Properly maintained cutting tools with sharp cutting edges are less likely to bind and are easier to control.
- Use the power tool, accessories and tool bits etc. in accordance with these instructions, taking into account the working conditions and the work to be performed. Use of the power tool for operations different from those intended could result in a hazardous situation.

Service

- Have your power tools serviced by a qualified repair person using only identical replacement parts. This will ensure that the safety of the power tool is maintained.

INTENDED USE

This hedge trimmer is designed for domestic use only:

- to cut and trim hedges, bushes and ornamental shrubs. Any other use that is not explicitly approved in these instructions may result in damage to the equipment and represent a serious danger to the user.
- to use with accessories and replacement parts approved by Spear & Jackson.

Any use of the machine that deviates from its intended use and is not included in these.

IN THE BOX

PARTS

- 1 Cutting blades
- 2 Front guard
- 3 Front handle
- 4 Safety switch
- 5 Air vent
- 6 Rear handle
- 7 On/off switch
- 8 Power cord with plug
- 9 Cord strain relief
- 10 Blade sheath

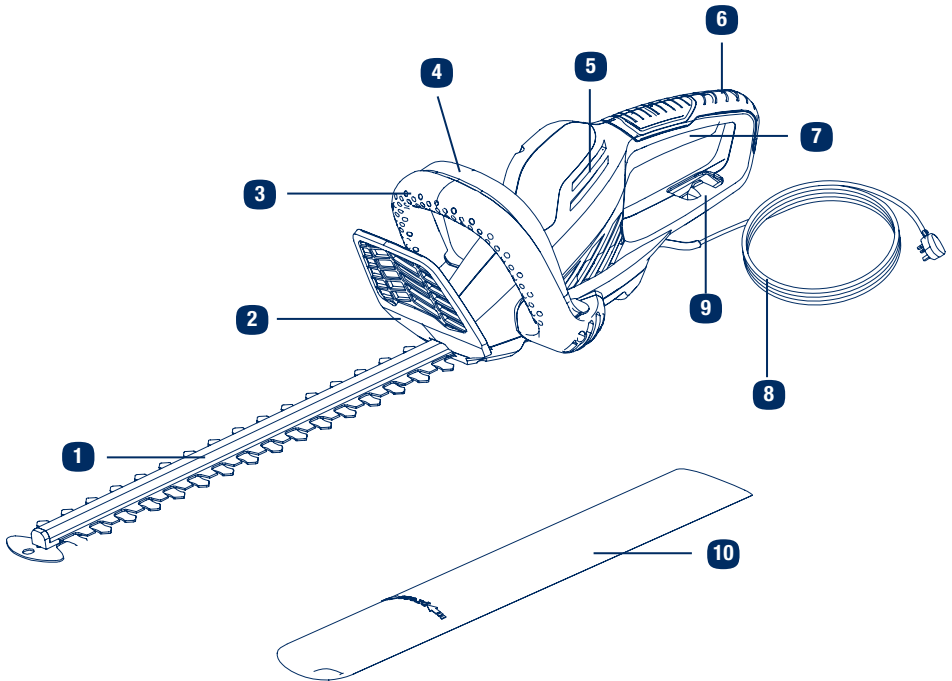

If there are any parts missing, please call the customer helpline on 0345 605 2067

ASSEMBLE

1 Unpacking

- i. Unpack all parts and lay them on a flat, stable surface.
- ii. Make sure all parts and accessories are included and undamaged. If you find that parts are missing or show damage please contact the after sales service at 0345 605 2067. Use of an incomplete or damaged product represents a hazard to people and property.
- iii. Ensure that you have all the accessories and tools needed for assembly and operation. This also includes suitable personal protective equipment (PPE).

2 Blade sheath

- i. Remove the blade sheath (10) from the cutting blades (1) before operation .
- ii. After use align the blade sheath (10) to the cutting blades (1) and push it onto it to attach. Ensure the sheath engages properly, check by pulling. It may not be possible to simply pull off the sheath.

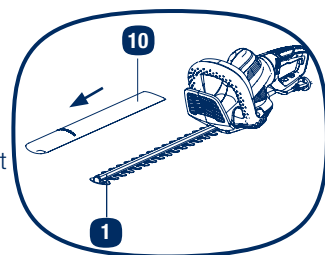

NOTE: Always attach the blade sheath (10) when the product is not in use, for storage and transportation.

ASSEMBLE

3 Connection to the power supply

- i. Double the cord, about a foot from the end. Lead the loop through the hole on the rear safe guard and hook the loop over the cord strain relief (9). Gently pull on the cord to ensure that it is firmly attached.

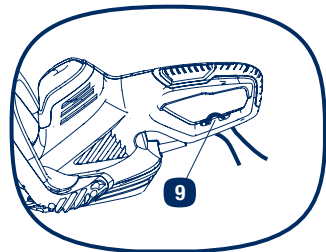

- ii. Connect the plug of the cable to the mains socket.

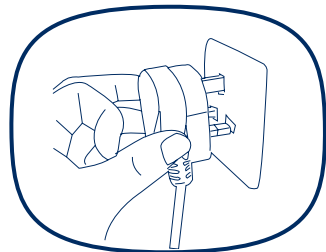

OPERATE

GENERAL OPERATE

- Check the product, its power cord and plug as well as accessories for damage before each use. Do not use the product if it is damaged or shows wear.
- Double check that accessories or cutting device are properly fixed.
- Always hold the product by its handles. Keep the handles dry to ensure safe support.
- Ensure that the air vents are always unobstructed and clear. Clean them if necessary with a soft brush. Blocked air vents may lead to overheating and damage the product.
- Switch the product off immediately if you are disturbed while working by other people entering the working area. Always let the product come to complete stop before putting it down.
- Do not overwork yourself. Take regular breaks to ensure you can concentrate on the work and have full control over the product.



WARNING - Wear suitable clothing, ears and eyes protecting when working with the equipment. Ensure that the mains voltage value matches the label on the equipment.

Remove the blade sheath

Remove the blade sheath (10) from the blade (1) of appliance carefully .

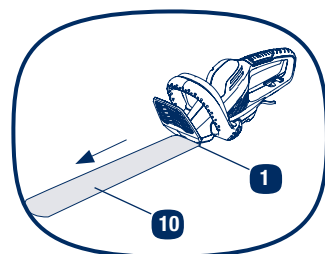

OPERATE

Switching on/off

- i. Hold the product with one hand at the rear handle (6) and with the other at the front handle (3).
- ii. Press the on/off switch (7) and the safety switch (4) at the same time to switch the product on.
- iii. Release either the on/off switch (7) or the safety switch (4) to switch the product off.

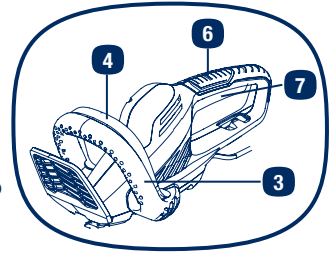

Trimming times

Green leaf hedges	June to October
Evergreens	April and August
Conifers and other fast growing shrubs	every 6 - 8 weeks

NOTE: Only operate the product during reasonable hours - not early in the morning, late at night or on weekends/public holidays when people might be disturbed. Please check local restrictions.

Trimming

- i. Cut and remove branches exceeding the cutting capacity of this product using a proper pruner before operation.
- ii. Move the cutting device lightly through the surface to be cut in a sweeping motion following the shape of the hedge or shrub.
- iii. A slight tilt downwards of the cutting device in the direction of motion is recommended for optimum cutting performance.
- iv. Do not to rush and do not attempt to cut too much with one stroke of the cutting device.

OPERATE

- v. First cut both sides from the bottom cutting upwards to the top. This will prevent any of the trimmings falling into the path of the area still to be cut.



- vi. After cutting the sides proceed to the top. Try to keep the cutting device angled at approximately 15° to the cutting surface.

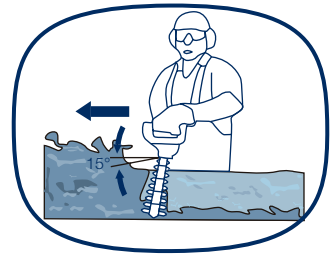

- vii. Cut in a number of stages if the area being cut is particularly long to achieve a better result; smaller trimmings will allow for easy composting.

NOTE: When shaping it is advisable to achieve a trapezoidal shape. A trapezoidal cut corresponds to the natural growth of plants and results in optimal hedge growth, as it will expose more light to the lower end of the hedge.

MAINTENANCE



WARNING! Always switch the product off, disconnect it from the power supply and let the product cool down before performing inspection, maintenance and cleaning work!

- Regular and proper cleaning will help ensure safe use and prolong the life of the product.
- Inspect the product before each use for worn and damaged parts. Do not operate it if you find broken and worn parts.
- Lubricate the internal surfaces of the blades with gear grease after each use.

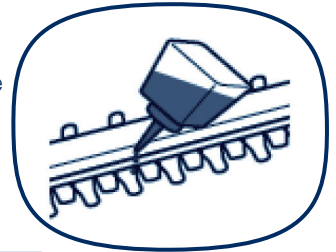

General cleaning

- i. Switch the product off, disconnect it from the power supply and let it cool down.
- ii. Check, clean and store the product as described below.
- iii. Clean the product with a damp cloth and pH-neutral soap. Use a brush for areas that are hard to reach.
- iv. In particular clean the air vents after every use with a cloth and brush.
- v. Remove stubborn dirt with high pressure air (max. 3 bar).

NOTE: Do not use chemical, alkaline, abrasive or other aggressive detergents or disinfectants to clean this product as they might be harmful to its surfaces.

Cleaning the blades



WARNING! Wear safety gloves when working on blades and close to it! Use appropriate tools to remove debris, e.g. a brush or wooden stick! Never use your bare hands!

Always use original spare parts for replacement.

- i. Keep the blades (1) clean and free of debris. Remove trimmings.
 - ii. Apply a small amount of suitable lubricant, like gear grease, on the cutting device (1) to retain a good cutting performance.
-
-

Repair

This product does not contain any parts that can be repaired by the consumer. Contact the after sales support if you have any queries.

MAINTENANCE

Storage

- i. Clean the product as described above.
 - ii. Attach the blade sheath.
 - iii. Store the product and its accessories in a dry, frost-free place.
 - iv. Always store the product in a place that is inaccessible to children. The ideal storage temperature is between 10 - 30°C.
 - v. We recommend using the original package for storage or covering the product with a suitable cloth or enclosure to protect it against dust.
-
-

Transportation

- i. Switch the product off and disconnect from power supply.
 - ii. Attach the blade sheath.
 - iii. Always carry the product by its handles/gripping surfaces.
 - iv. Protect the product from any heavy impact or strong vibrations which may occur during transportation in vehicles.
 - v. Secure the product to prevent it from slipping or falling over.
-
-

Recycling and disposal

- The product comes in a package that protects it against damage during shipping. Keep the packaging until you are sure that all parts have been delivered and the product is functioning properly. Recycle the packaging afterwards.
- Old products are potentially recyclable and do not, therefore, belong in your household waste. You are requested to assist us and our contribution to saving resources and protecting the environment by handing in this product at an equipped collection centre.



TECHNICAL DATA

Model	HTEG48A-450
Input voltage rating	230-240V ~,50Hz
Input power	450W
Max. cutting length	400mm
Max. cutting capacity	16mm
Safety class	class II
Weight	3.2kg

Part number	Accessories
HT500-01	Blade sheath

Measured sound pressure level: LpA:87dB(A), K=3dB(A)

Measured sound power level: LwA:99 dB(A), K=3dB(A)

Guaranteed sound power level: LwA:99dB(A)

Vibration values:

Hand arm vibration a_{H1} : 5.8 m/s²

Uncertainty K: 1.5 m/s²

The sound values have been determined according to noise test code given in a standard (EN 60745), using the basic standards EN ISO 11094 and EN ISO 3744.

The sound intensity level for the operator may exceed 80dB(A) and ear protection measures are necessary.

The declared vibration value has been measured in accordance with a standard (EN 60745) test method and may be used for comparing one product with another. The declared vibration value may also be used in a preliminary assessment of exposure.

WARNING! Depending on the actual use of the product the vibration values can differ from the declared total! Adopt proper measures to protect yourself against vibration exposures! Take the whole work process including times the product is running under no load or switched off into consideration!

Proper measures include among others regular maintenance and care of the product and cutting attachments, keeping hands warm, periodical breaks and proper planning of work processes!

TROUBLESHOOTING

Suspected malfunctions are often due to issues that the user can fix themselves. Therefore, check the product using this section. In most cases the problem can be solved quickly.



WARNING! Only perform the steps described within these instructions! All further inspection, maintenance and repair work must be performed by an authorised service centre or a similarly qualified specialist if you cannot solve the problem yourself!

Problem	Possible Cause	Solution
1. Product does not start	<ul style="list-style-type: none">• Not connected to power supply• Power cord or plug is defective• Other electrical defect to the product	<ul style="list-style-type: none">• Connect to a proper power supply• Call after sales support at 0345 605 2067• Call after sales support at 0345 605 2067
2. Product does not reach full power	<ul style="list-style-type: none">• Extension cord is not suitable for this product• Power source (e.g. generator) has too low a voltage• Air vents are blocked	<ul style="list-style-type: none">• Use a proper extension cord• Connect to another proper power supply• Clean the air vents
3. Unsatisfactory result	<ul style="list-style-type: none">• The branches are too thick	<ul style="list-style-type: none">• Only cut branches within the limits
4. Excessive vibration/ noise or exhaust	<ul style="list-style-type: none">• Loose screws	<ul style="list-style-type: none">• Call after sales support at 0345 605 2067

WARRANTY

If your device develops a fault, please don't hesitate to contact our customer service department on 0345 605 2067, we can solve 80% of problems via the phone.

1. These warranty terms cover additional warranty rights and do not affect your statutory warranty rights. All our products are covered by a 3 year manufacturer warranty.
2. Claims must be accompanied by Proof of Purchase. This must be in the form of a Sales receipt or Bank statement and must show that the product has been purchased within the warranty period as described under point 1, from the retailer that it was originally bought from. Please keep your receipt safe or staple it to the back of this manual for future reference.
3. Our warranty covers problems caused by material or manufacturing defects, and will result in the repair of these defects or replacement of the device with a like for like or similar article.
4. Our devices have not been designed for commercial, trade or industrial applications, any signs of use of the equipment in these application or equivalent activities, invalidates the warranty.
5. The following are also excluded from our warranty:
 - A. Faults due to accidents, customer misuse or unauthorized repairs
 - B. Consumable Parts such as blade covers, cables, and accessories that are compatible with the product.
 - C. Failure due to lack of routine maintenance.
 - D. Failure as a result of not using the equipment in accordance with the manual and safety instructions
 - E. The adjustment of cables, drive gears, or blades

Warranty claims should be submitted before the end of the warranty period, see point 1, but a paid service exists for repairs commissioned after this period. The original warranty period remains applicable to the device even if repairs are carried out or parts are replaced. In such cases, the work performed or parts fitted will not result in an extension of the warranty period, and no new warranty will become active for the work performed or parts fitted.

If you have any problems or questions concerning your garden power tool, please contact our after sales service at 0345 605 2067.

