

# Components

# HME CHAIR IN A BOX

Simple Assembly Instructions-Please keep for future reference

-----6126311/6214560/6996228/7259476

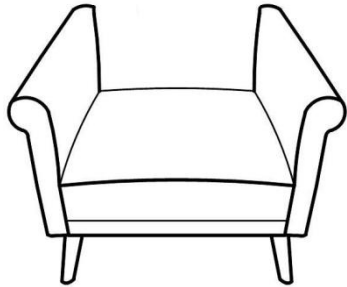

A.1XSEAT WITH ARMREST

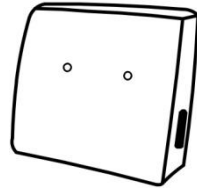

B.1XBACKREST

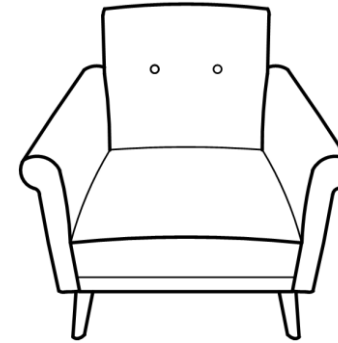



# Fittings

Important-Please read these instructions fully before starting assembly

If you need help or have damaged or missing parts, call the Customer Helpline:

0345 640 0800

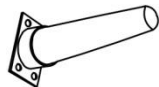
## HARDWARE LIST:

|    |   |       |
|----|---|-------|
| C: |  | 4PCS  |
| D: |  | 1PC   |
| E: |  | 16PCS |

1. Read these instructions carefully and familiarize yourself with the procedure before assembling the unit.

2. Check that you have all the component parts following the list on the back cover and familiarize yourself with each part before proceeding.

3. take all the fittings out of the plastic bag and separate them into their groups.

4. ensure you have enough space to lay out all the parts before assembly.

5. To avoid scratching it is recommended that you assemble the unit on a soft level surface.

# Assembly Instructions

1. Taking out the fittings for leg assembly from the fitting carton.

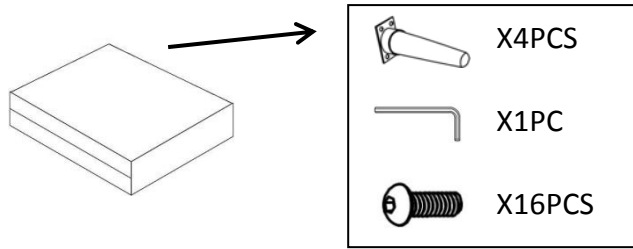

2. Fitting the legs on the bottom of the seat with correct orientation.

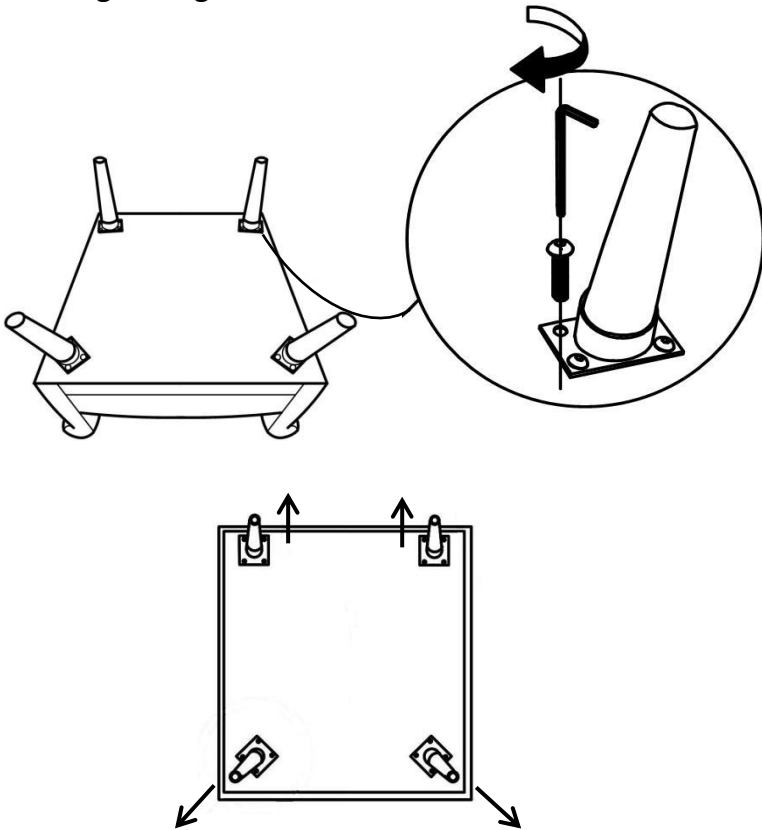

# Assembly Instructions

3. Fitting the back by connecting the inserts on the arm and back.

NOTE: It would be useful to ask someone to help you at this stage.

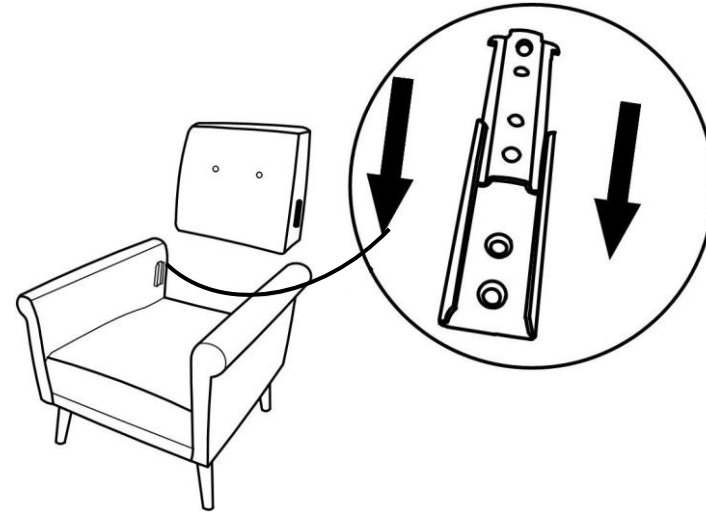

4. Finally carefully place the unit in the desired location.

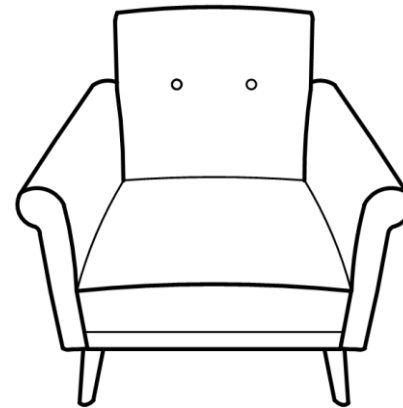

# Care and Maintenance

## Safety

To avoid any risk of suffocation to animals or children dispose of the plastic bags immediately.

## Cleaning

As with all surfaces clean with a damp cloth and mild detergent, do not use bleach or abrasive products.

## Fitting

From time to time please ensure there are no loose screws on the product.

If you need help or have damaged or missing parts, call the **Customer Helpline: 0345 640 0800.**

489-499 Avebury Boulevard Milton Keynes MK9 2NW, Argos Limited.