

VC734030MUK Rev2

# morphy richards®

smart ideas for your home



\* Register at [www.morphyrichards.co.uk/support](http://www.morphyrichards.co.uk/support)  
UK and Ireland customers only

## Supervac pro Cordless Vacuum Cleaner

 Please read and keep these instructions for future use

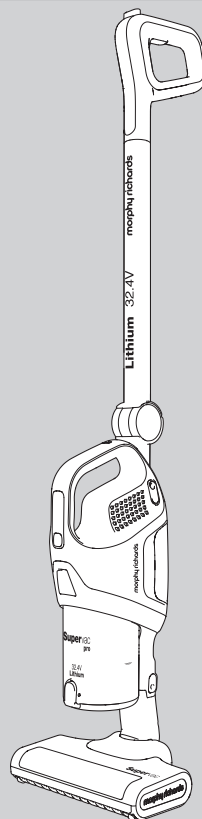

**CHARGE THE PRODUCT FULLY BEFORE FIRST USE**

For competitions, product hints and tips  
and more join us at



[www.morphyrichards.co.uk/blog](http://www.morphyrichards.co.uk/blog)



[www.facebook.com/morphyrichardsuk](http://www.facebook.com/morphyrichardsuk)



@loveyourmorphy

[www.morphyrichards.com](http://www.morphyrichards.com)

## Health and Safety

The use of any electrical appliance requires the following common sense safety rules.  
**Please read these instructions carefully before using the product.**

- **WARNING: Whenever the cleaner is in use, due to the risk of entrapment in rotating parts, keep loose clothing, hair, fingers etc. away from the brush bar, nozzle and any handheld accessories.**
- **WARNING: Disconnect from the mains supply and remove the handheld vacuum cleaner (15) before carrying out any routine maintenance, such as cleaning any blockages, changing any filters, accessing the motorised floor brush or removing the battery.**
- This appliance can be used by children aged from 8 years and above and persons with reduced physical, sensory or mental capabilities, or lack of experience and knowledge, if they have been given supervision or instruction concerning the use of the appliance in a safe way and understand the hazards involved.
- Only use the mains adaptor supplied with the unit.
- Children shall not play with the appliance.
- Cleaning and user maintenance shall not be undertaken by children without supervision.
- If the battery is damaged, do not use or try to charge it. Contact the helpline on the back page.
- Refer to page 11 for disposal of the product and battery.

### Personal safety

- **WARNING: Only lift the product by the handles (3 & 6) and never pick the cleaner up by the motorised floor brush.**
- **WARNING: Misuse of the appliance could cause personal injury.**
- To prevent accidental contact with the rotating brush bar, always remove the motorised floor brush (22) during maintenance.
- Never use in the presence of explosive liquid or vapours.
- Never pick up inflammable or poisonous liquids such as petrol, copier toner or other volatile substances. Never pick up acids, asbestos or asbestos dust.
- Never touch the adaptor, product or cable with wet hands.
- Unprofessional repairs can be dangerous for users.
- To protect against fire, electric shock and personal injury, do not immerse cord, mains adaptor or cleaner in water or other liquid.
- The appliance must never be left running unsupervised.

### Location

- Do not use or keep this product outside.
- Do not store the appliance near hot surfaces eg. ovens or heating appliances.

### Product safety

- This appliance is not intended for liquid/wet pick up.
- Never use the appliance without the filter being installed.
- Never use the appliance to vacuum hot ashes, broken glass, sharp objects or liquids.
- Never modify the cleaner in any way.
- Use only Morphy Richards spare parts and accessories.

### Electrical requirements

- Check that the voltage on the rating plate of the mains adaptor corresponds with your house electricity supply which must be A.C. (Alternating Current).
- The battery is not a serviceable item. Remove at the end of the product's life for recycling.

## Product overview

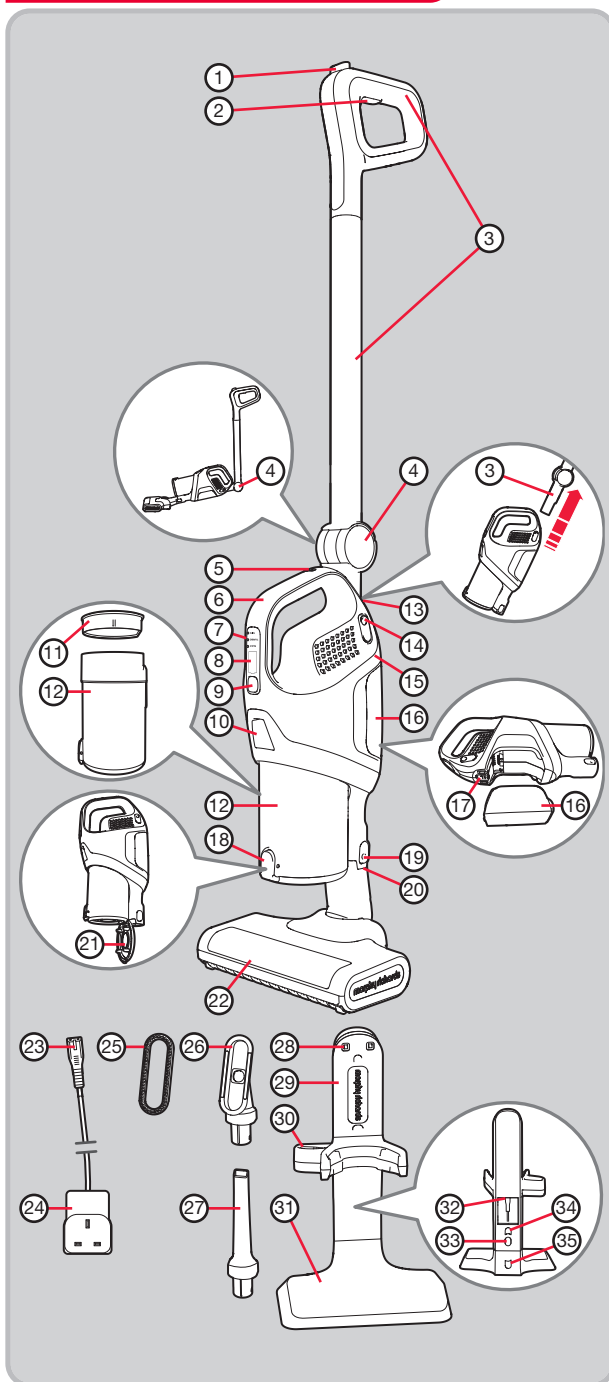

## Features

- (1) Back saver handle button
- (2) Upright handle On/Off button
- (3) Upright handle
- (4) Back saver pivot
- (5) Handheld charging inlet
- (6) Handheld vacuum cleaner handle
- (7) Power level indicator lights
- (8) Charge indicator
- (9) On/Off button
- (10) Dust canister release button
- (11) Main filter
- (12) Dust canister
- (13) Upright handle connector hole
- (14) Upright handle release buttons
- (15) Handheld vacuum cleaner
- (16) Battery
- (17) Battery release button
- (18) Dust canister swing base release button
- (19) Handheld vacuum cleaner attachments release buttons
- (20) Handheld vacuum cleaner suction inlet
- (21) Dust canister swing base
- (22) Motorised floor brush
- (23) Mains adaptor connector
- (24) Mains adaptor
- (25) Dusting brush
- (26) Upholstery nozzle
- (27) Crevice tool
- (28) Charging cradle electrical connectors
- (29) Charging cradle
- (30) Tool storage
- (31) Charging cradle base
- (32) Charging cradle charging inlet
- (33) Charging cradle base detach button
- (34) Upper cord storage hook
- (35) Lower cord storage hook

## Dual functionality

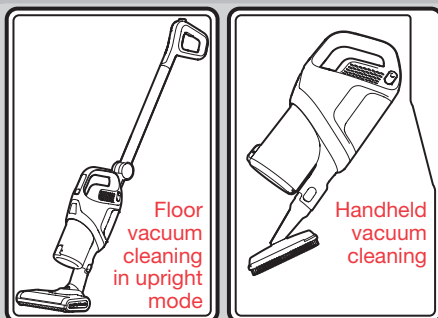

Your vacuum cleaner can easily be configured into two different cleaning modes:

- A vacuum cleaner for floors and carpets.
- Handheld vacuum cleaner which can be carried with you whilst cleaning.

## Set up and charging

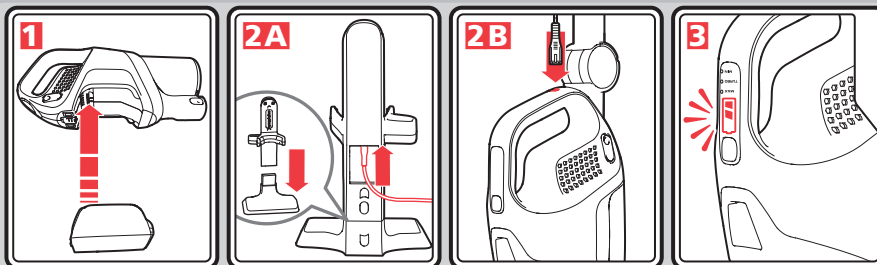

**Charge the product fully before first use.**

- 1** Fit the battery (16). Hook the lower end of the battery into the cleaner, then push the top of the battery firmly until it locks into place.

The battery will not need to be removed again unless the product reaches the end of its useful life.

### Removal of battery or replacement:

If the battery needs to be removed again, slide the battery release button (17) towards the handheld vacuum cleaner handle (6) and pull from the top end of the battery to remove.

Only use battery number 734000-B for this product.

In extreme conditions, batteries may be subject to leakage. If touched, wash skin with hot soapy water. Do not try to use or recharge the battery in this condition.

- 2A** Assemble the charging cradle (29) to the charging cradle base (31). If necessary, the two parts can be separated again by pressing the charging cradle base detach button (33), then pulling apart. Insert the mains adaptor connector (23) into the charging cradle charging inlet (32). Seat the vacuum cleaner into the charging cradle, ensuring the charging cradle electrical connectors (28) align with the handheld vacuum cleaner electrical connectors.

Connect the mains adaptor (24) to the mains supply.

- 2B** Alternatively (provided the unit is in the charging cradle (29)), insert the mains adaptor connector (23) into the handheld vacuum cleaner charging inlet (5). The connector will only fit one way. Connect the mains adaptor (24) to the mains supply.

After the adaptor is connected, the charge indicator (8) will illuminate within a few seconds.

- 3** When the battery is empty and the product is put onto charge, one bar of the charge indicator (8) will illuminate. As the battery charges, the second bar of the charge indicator will start to flash and then become steady, then the third bar will start to flash. When the illumination of all three bars is steady, the product is fully charged. A full charge may take 4 hours.

The three bars will stay illuminated for 5 minutes and then extinguish to save power.

If all three bars are flashing, this indicates a fault, please see 'Maintenance - troubleshooting', page 11.

When fully charged, the mains adaptor may be switched off and unplugged. If unused, the batteries will remain charged for many weeks so there is no need to keep constantly on charge.

## Assembly in upright mode

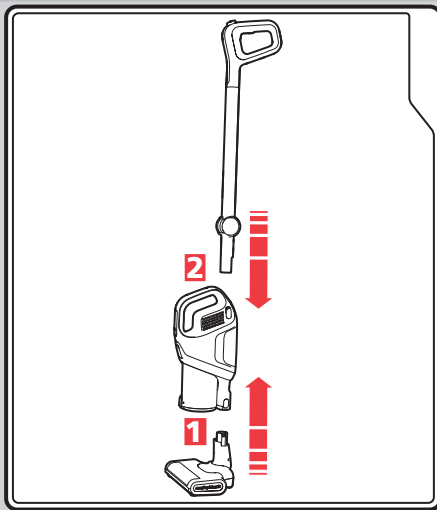

**1** Push the neck of the motorised floor brush (22) into the handheld vacuum cleaner suction inlet (20) until it clicks into place.

**2** Push the upright handle (3) into the upright handle connector hole (13).

## Switching on and power settings

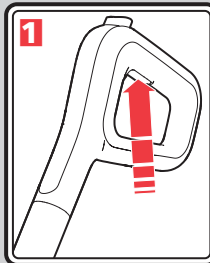

**1** If floor vacuum cleaning in upright mode, press the upright handle On/Off button (2).

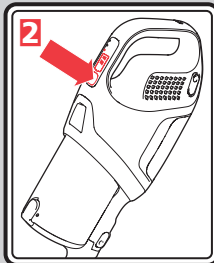

**2** If handheld vacuum cleaning, press the On/Off button (9).

**3** Pressing either button (2 or 9) will switch the product on at MAX. A second press will change the power to TURBO, a third press will change the power to MIN and a fourth press to OFF. The product may also be switched off by pressing the switch continuously for 2 seconds.

When the product is on, one of the three power level indicator lights (7) will illuminate to display which power setting has been selected and the charge indicator (8) will also illuminate to show the amount of battery charge remaining.

The MAX setting should be sufficient for the majority of cleaning tasks. The TURBO setting will produce the best cleaning results, but the battery charge will be used more quickly. Using on MIN power will be sufficient for light

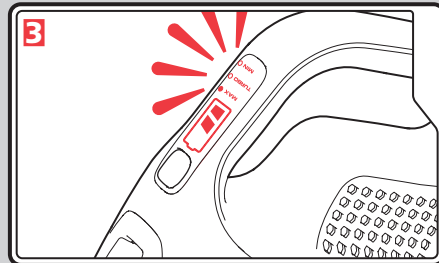

cleaning and will extend the usage time before the battery needs recharging.

**NOTE: The motorised floor brush (22) will not rotate when the MIN setting is chosen.**

As the battery charge is diminished during use, the number of illuminated bars on the charge indicator (8) will reduce. When the last bar starts to flash, the battery charge is close to its minimum limit. The product will automatically stop when the battery charge reaches its minimum limit. The battery must then be re-charged.

**NOTE: Using the product on MAX/TURBO setting will give approximately 15 minutes of use. Using the product on the MIN setting will give up to 60 minutes of use in the handheld mode. After approximately 15 minutes of continuous use on the MAX/TURBO setting, the power will automatically reduce to the MIN setting to prevent over-discharge of the battery.**

## Using in upright mode

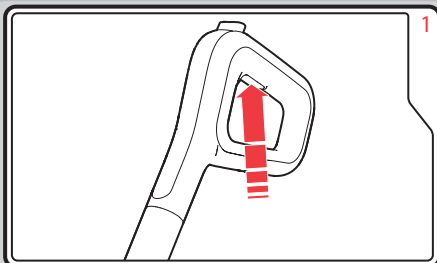

Assemble the product for upright vacuum cleaning (see 'Assembly in upright mode', page 5).

**IMPORTANT:** When using the motorised floor brush (22), never keep it in one location on the floor for an extended period and do not leave the product running whilst standing still. The rotating brush bar could cause damage to some floor coverings if the floor is exposed to the rotating brush action for a continued period of time.

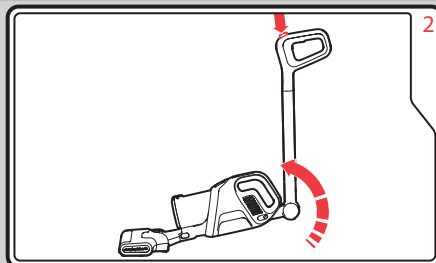

If cleaning floors under tables, chairs or low lying furniture, press the back saver handle button (1) to pivot the upright handle forwards, allowing the main body to drop parallel with the floor without you having to bend down.

## Handheld vacuum cleaning

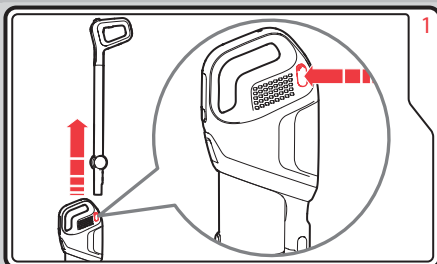

This function is ideal for cleaning stairs, curtains and upholstery.

To separate the upright handle (3) from the handheld vacuum cleaner (15), press the upright handle release buttons (14) and pull the upright handle away from the handheld vacuum cleaner.

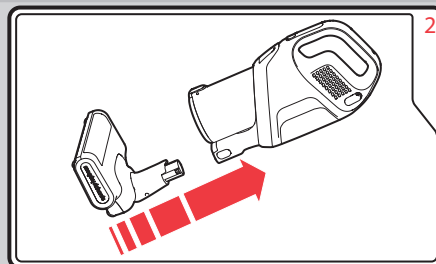

To attach the motorised floor brush (22) to the handheld vacuum cleaner (15), push the neck of the motorised floor brush into the handheld vacuum cleaner suction inlet (20) until it clicks into place.

To separate the motorised floor brush from the handheld vacuum cleaner, press the handheld vacuum cleaner attachments release buttons (19) and pull the motorised floor brush away from the handheld vacuum cleaner.

## Handheld vacuum cleaning (continued)

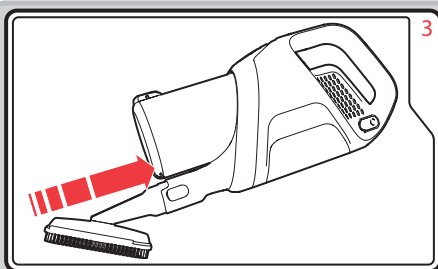

To use the crevice tool (27) upholstery nozzle (26), or dusting brush (25) in place of the motorised floor brush (22), align the ridges on the side of the tool with the grooves inside the handheld vacuum cleaner suction inlet (20) and push in place until a click is heard. To remove it again, press the handheld vacuum cleaner attachments release buttons (19).

NOTE: To use the dusting brush (25), it must be attached to the upholstery nozzle (26) (see 'Using the attachments', below).

## Using the attachments

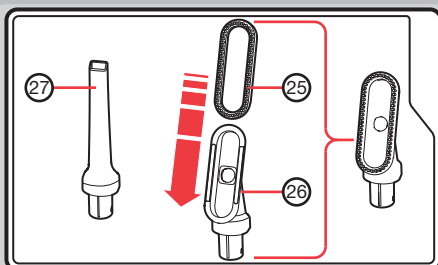

### Crevice tool and brushes

**Crevice tool (27)** for awkward places, corners and behind radiators etc. This tool is also useful on stairs.

**Dusting brush (25)** for carpet, upholstery and stairs etc.

**Upholstery nozzle (26)** for upholstery and bedding etc.

The dusting brush (25) must be attached to the upholstery nozzle (26). Slide the dusting brush on to the front of the upholstery nozzle until it clicks into place, as shown.

## Tool storage

When not in use, the attachments may be stored in the tool storage (30) on the charging cradle (29) as shown (below).

1. Attach the dusting brush (25) to the upholstery nozzle (26) as shown in 'Using the attachments'.
2. Slide the combined dusting brush and upholstery nozzle onto the crevice tool (27).
3. Push the base of the crevice tool into the tool storage.

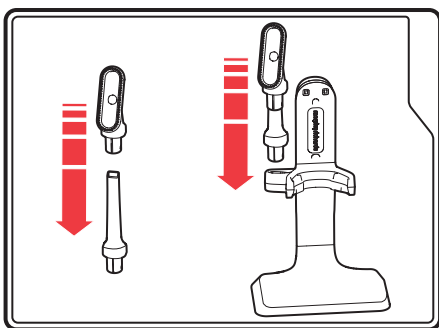

## Maintenance

**The guarantee may be invalidated if the motor is damaged due to: using the appliance without the filter(s) installed; not cleaning the filter(s); or not replacing a damaged filter.**

Your cleaner is manufactured to withstand normal day-to-day use, but occasionally wipe over with a damp cloth to help maintain its good looks. Take care not to get the electrical connections wet.

Abrasive cleaners should not be used.

## Maintenance - emptying the dust canister and cleaning the filters

Empty the dust canister (12) regularly even if it does not look full, this will maintain the performance.

To ensure optimum suction and performance, we recommend that the canister is only filled to the line shown on the side of the canister.

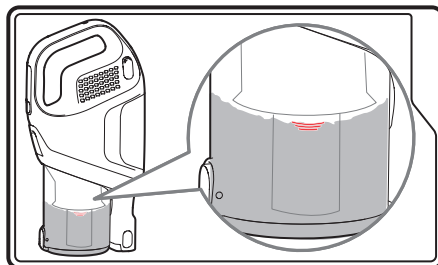

**We recommend cleaning the filter (11) every time the dust canister (12) is emptied.**

The dust canister can be quickly and easily emptied:

1. Press the dust canister release button (10) and pull the dust canister (12) away from the handheld vacuum cleaner (15).
2. Remove the main filter (11) and set aside.

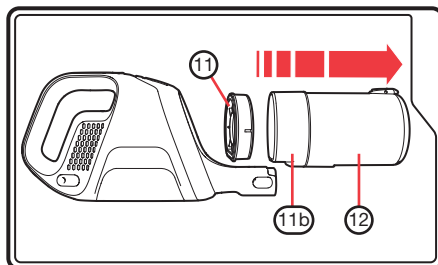

3. Use the dust canister swing base release button (18) to open the dust canister swing base (21).

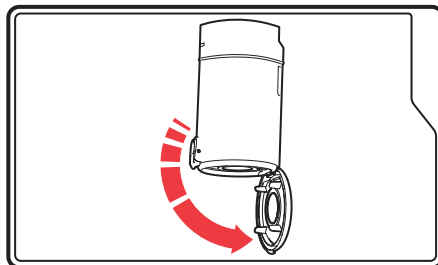



4. Empty the dirt from inside the dust canister and push the swing base closed again.
5. Remove the foam filter (11a) from the main filter (11).

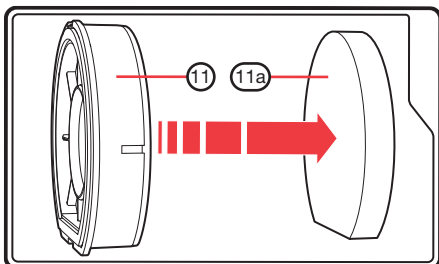

6. Dust off the foam filter each time the dust canister is emptied.

Every month, wash the foam filter in luke-warm water and thoroughly air dry before re-fitting.

**IMPORTANT: Do not wash the filter(s) with hot water or detergents.**

**IMPORTANT: Do not use heated appliances to dry the filter(s).**

7. Replace the foam filter into the main filter.
8. Replace the main filter into the top of the dust canister and replace the dust canister into the handheld vacuum cleaner (15).

**IMPORTANT: Never use the product without the main filter (11) and the foam filter (11a) fitted.**

### Cleaning the dust canister filter

To maintain suction, the filter in the dust canister must be cleaned regularly.

Follow steps 1 - 4.

9. Twist the dust canister filter (11b) slightly anti-clockwise to unlock, then pull away from the dust canister.

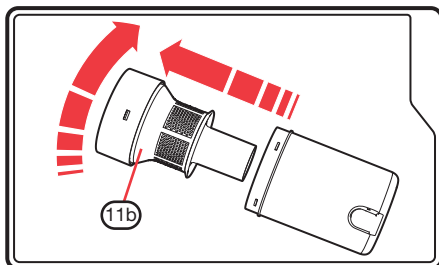

10. Twist **part C** anti-clockwise, this will unlock the whole assembly ready for cleaning.

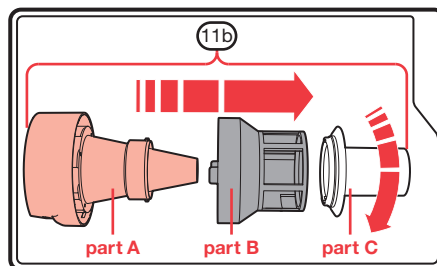

11. Brush clean all parts of the dust canister filter to remove any hairs or fibres.
12. When putting the dust canister filter back together again, align the tabs on **part B** with the holes on **part A**. Of the six mesh windows on **part B**, one of them is half size, this window goes to the bottom (almost in line with the flat edge of **part A**). Place **part B** onto **part A** and hold in place.

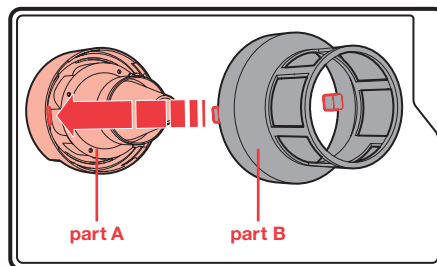

13. Whilst holding **part A** and **part B** together. Align the tabs on the cone section of **part A** with the gaps on **part C** and bring together, then twist **part C** clockwise to lock all parts together.

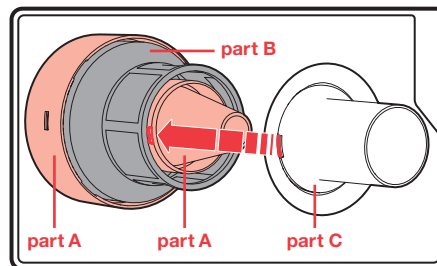

14. To refit the dust canister filter (11b) back into the dust canister, align the arrow graphic on **part A** with the unlocked padlock arrow graphic on the dust canister, then twist so the arrow graphic on **part A** aligns with the locked padlock arrow graphic on the side of the dust canister.
15. Refit the main filter (11) into the dust canister filter (11b).
16. Refit the dust canister (12) into the handheld vacuum cleaner (15), ensuring the dust canister swing base release button (19) faces away from the handheld vacuum cleaner.

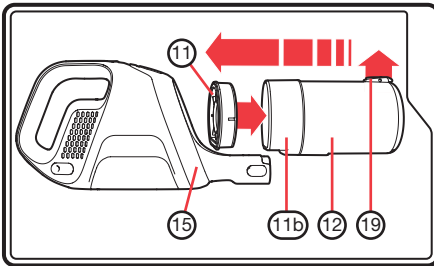

## Maintenance - motorised floor brush

**WARNING:** The motorised floorbrush (22) must be removed before any maintenance operations.

**WARNING:** Take care when using tools and sharp objects.

1. If the motorised floor brush (22) is stalled, eg. by a foreign object or if used on very deep pile carpet, the power level indicator lights (7) will flash. If this happens, switch off, remove the motorised floor brush and then remove the cause of the stall. Leave for a few minutes to allow the floor brush protection to self reset.
2. To clean the motorised floor brush, turn the unit off, press the handheld vacuum cleaner attachments release buttons (19) and pull the motorised floor brush away.

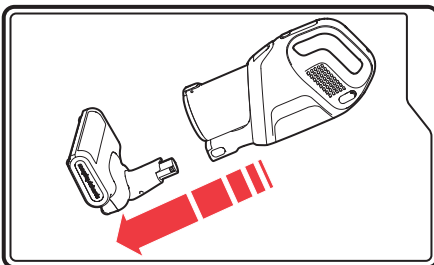

3. Turn the motorised floor brush (22) over to inspect the rotating brush bar (22c).

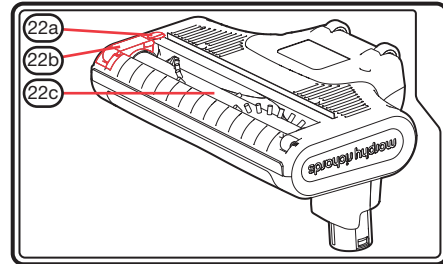

4. Using a small flat bladed screwdriver gently turn the locking button (22a) 1/8 turn clockwise to unlock the cover. Remove the cover (22b). Using the small flat bladed screwdriver underneath the end of the rotating brush, gently lift the rotating brush bar (22c) out.

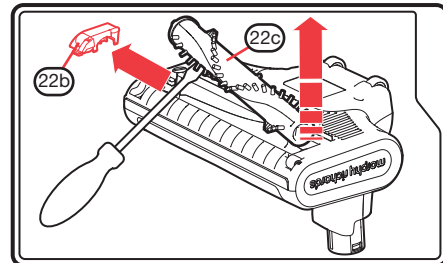

5. Pull-away any hairs or fibres from around the rotating brush bar. If they are tightly wound around the brush carefully snip the fibres/hairs with scissors using the groove in the brush to assist. Take care not to damage the brush bristles. Inspect both ends of the brush for hairs & fibres and remove if necessary. The end cap of the brush that sits underneath the brush bar cover (22b) should rotate freely.
6. Before the replacing the motorised floor brush (22), check to ensure there are no blockages in the inlet aperture.
7. Replace the rotating brush bar and brush bar cover in their original position and re-lock the locking button (22a).

## Maintenance - troubleshooting

- **“Does not pick-up”/ “Motorised floor-brush running slow or soon stops”**

Check for hairs/fibres that may be wrapped around the rotating brush-bar.

**IMPORTANT:** Remove the rotating brush bar as described on page 10. Fine hairs or fibres may be caught in the ends of the rotating brush bar. Carefully remove the hairs and re-fit the rotating brush bar.

- **“All three power level indicator lights are flashing”**

If all three power level indicator lights (7) are flashing, this indicates that the rotating brush cannot rotate due to a restriction/blockage.

Turn the product off, remove the motorised floor brush (22) and then check the rotating brush for any item that may be stopping the brush from rotating. This may include hairs or fibres wrapped around the end of the brush. If necessary, remove the rotating brush (as shown on page 10) to remove any hairs/fibres.

- **“Does not pick-up” / “Suction of handheld cleaner has reduced”**

In addition to emptying the dust canister, it is very important that the filters are regularly and thoroughly cleaned. See pages 8, 9 and 10 for details of how to access and clean the filters.

- **“Does not pick-up from the floor but the motorised floor brush is rotating and the handheld has good suction”**

Switch off the product, remove the motorised floor brush and check for blockages.

- **“Product not charging”**

Check the charge indicator (8) on the top of the handheld vacuum cleaner is flashing to indicate that charging is in process. If the indicator is not showing, check: **a)** the mains adaptor (24) is correctly fitted into the charging inlet (5 or 32); **b)** the mains adaptor is fully fitted into the mains socket and the socket is switched on.

- **“Three bars flashing on charge indicator”**

If all three bars on the charge indicator (8) are flashing, this indicates a fault condition and the mains adaptor (24) should be removed from the mains socket. Check that the battery is fully fitted.

Check the correct charger is being used.

Charger/adaptor:

MODEL: YLS0241A-U400065 or YSL0241A-E400065

INPUT: 100-240V~ 50/60Hz, 0.8A Max

OUTPUT: 40VDC, 650mA

## Disposal

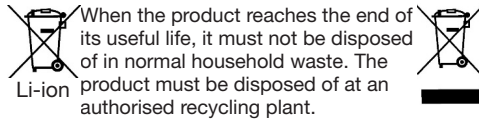

The battery should be removed and disposed of at an authorised recycling plant. Your local authority will have a centre which accepts such waste for recycling.

To remove the battery, slide the battery release button (17) towards the handheld vacuum cleaner handle and pull the battery away from the handheld vacuum cleaner (15).

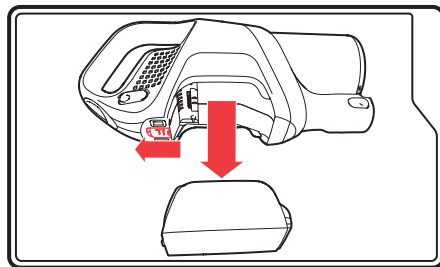

**WARNING: Batteries and products containing batteries must never be disposed of in fires.**

## Contact us

### Helpline

If you are having a problem with your appliance, please call our Helpline, as we are more likely to be able to help than the store you purchased the item from.

Please have the product name, model number and serial number to hand when you call to help us deal with your enquiry quicker.

UK Helpline: **0344 871 0944**

IRE Helpline: **1800 409 119**

Spares: **0344 873 0710**

### Talk To Us

If you have any questions or comments, or want some great tips to help you get the most out of your products, join us online:

Blog: **[www.morphyrichards.co.uk/blog](http://www.morphyrichards.co.uk/blog)**

Facebook: **[www.facebook.com/morphyrichardsuk](https://www.facebook.com/morphyrichardsuk)**

Twitter: **[@loveyourmorphy](https://twitter.com/loveyourmorphy)**

Website: **[www.morphyrichards.com](http://www.morphyrichards.com)**

VC734030MUK Rev2 03/17

## Registering your 2 year guarantee

Your standard 1 year guarantee is extended for an additional 12 months when you register the product within 28 days of purchase with Morphy Richards. If you do not register the product with Morphy Richards within 28 days, your product is guaranteed for 1 year. To validate your 2 year guarantee, register with us online at [www.morphyrichards.co.uk](http://www.morphyrichards.co.uk)

Or call our customer registration line

**UK 0344 871 0242**

**IRE 1800 409 119**

N.B. Each qualifying product needs to be registered with Morphy Richards individually.

**Please note that the 2 year guarantee is only available in the UK and Ireland.** Please refer to the 1 year guarantee for more information.

## Your 1 year guarantee

To qualify for the 1 year guarantee, the appliance must have been used according to the instructions supplied.

It is important to retain the retailer's receipt as proof of purchase. Staple your receipt to this back cover for future reference.

Please quote the following information if the product develops a fault. These numbers can be found on the base of the product.

Model no.

Serial no.

All Morphy Richards products are individually tested before leaving the factory. In the unlikely event of any appliance proving to be faulty within 28 days of purchase, it should be returned to the place of purchase for it to be replaced.

If the fault develops after 28 days and within 1 year (2 years if registered) of original purchase, you should contact the Helpline number quoting Model number and Serial number on the product, or write to Morphy Richards at the address shown.

You may be asked to return a copy of proof of purchase. Subject to the exclusions set out below (see Exclusions), the faulty appliance will then be repaired or replaced and dispatched usually within 7 working days of receipt.

If you suspect a fault, follow the simple checks detailed below before retrying the appliance or calling the helpline.

- Check the filters for blockages and clean.
- Check the tools / tubes for blockages.
- Check the appliance is charged.
- Check the socket used for charging is working and the charging adaptor is firmly in the socket during charging.

If, for any reason, this item is replaced during the 1 year guarantee period, the guarantee on the new item will be calculated from original purchase date. Therefore it is vital to retain your original till receipt or invoice to indicate the date of initial purchase. To qualify for the 1 year guarantee, the appliance must have been used according to the instructions supplied.

This appliance is intended for domestic use only. Misuse or use for commercial or any other purpose will render the guarantee invalid.

## Exclusions

Morphy Richards shall not be liable to replace or repair the goods under the terms of the guarantee where:

- 1 The fault has been caused or is attributable to accidental use, misuse, negligent use or used contrary to the manufacturer's recommendations or where the fault has been caused by power surges or damage caused in transit.
  - 2 The appliance has been used on a voltage supply other than that stamped on the products.
  - 3 Repairs have been attempted by persons other than our service staff (or authorised dealer).
  - 4 The appliance has been used for hire purposes or non domestic use.
  - 5 The appliance is second hand.
  - 6 Morphy Richards reserves the right not to carry out any type of servicing under the guarantee at its discretion.
  - 7 The guarantee excludes consumables such as the filter.
- This guarantee does not confer any rights other than those expressly set out above and does not cover any claims for consequential loss or damage. This guarantee is offered as an additional benefit and does not affect your statutory rights as a consumer. Morphy Richards products are intended for household use only. See usage limitations within the location safety instructions.

## Disclaimer

Morphy Richards has a policy of continuous improvement in product quality and design. The company, therefore reserves the right to change the specification of its models at any time.



For electrical products sold within the European Community. At the end of the electrical products useful life, it should not be disposed of with household waste. Please recycle where facilities exist. Check with your Local Authority or retailer for recycling advice in your country.



Battery should be removed at the end of the product's life for recycling.

Li-ion

**IF YOU ARE HAVING A PROBLEM  
WITH ONE OF OUR PRODUCTS,  
CALL OUR HELPLINE:**

**UK: 0344 871 0944  
EIRE: 1800 409 119  
SPARES: 0344 873 0710**

**morphy richards**

The After Sales Division  
Morphy Richards Ltd  
Mexborough,  
South Yorkshire,  
England, S64 8AJ

[www.morphyrichards.com](http://www.morphyrichards.com)

