

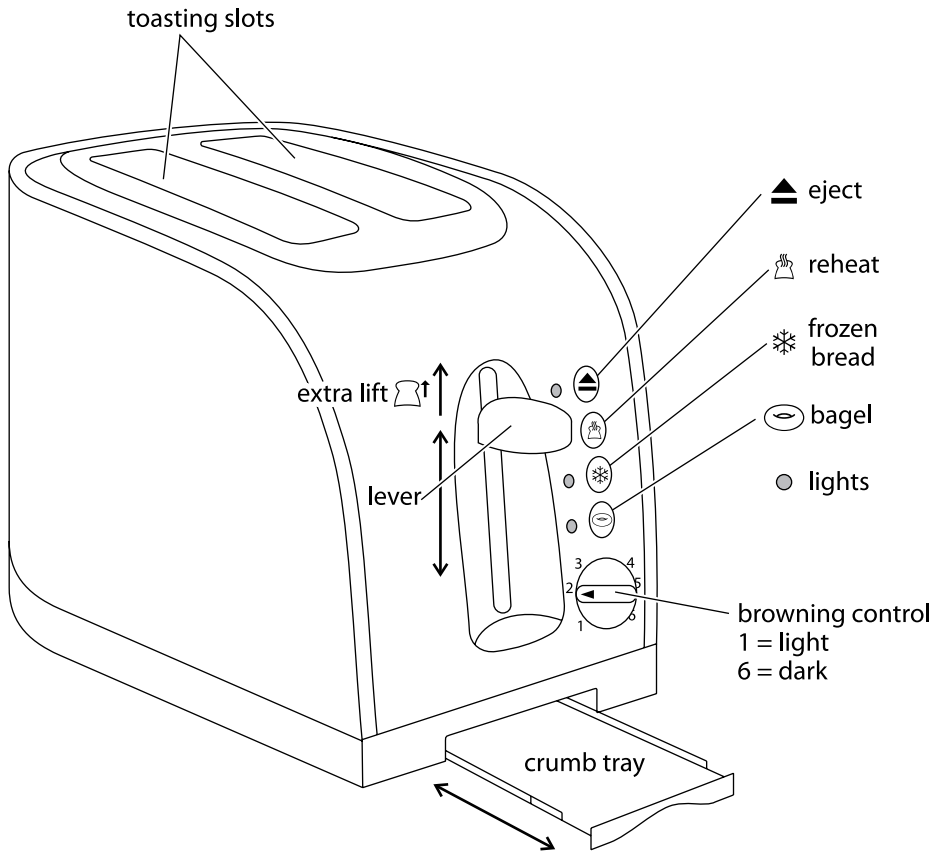

Russell Hobbs



instructions



Read the instructions and keep them safe. Pass them on if you pass the toaster on. Remove all packaging, but keep it in case you ever need to return the toaster.

important safeguards

Follow basic safety precautions, including:

- 1 The toaster must only be used by or under the supervision of a responsible adult. Use and store it out of reach of children.
- 2 Don't put the toaster in liquid, don't use it in a bathroom, near water, or outdoors. 
- 3 Sit the toaster upright, on a stable, level, heat-resistant surface.
- 4 Don't put it on or near anything that could be damaged even by moderate heat.
- 5 Bread may burn. Don't use the toaster near or below curtains or other combustible materials, and watch it while it's hot.
- 6 The area round the toasting slots gets very hot – don't touch!
- 7 Route the cable so it doesn't overhang and can't be caught.
- 8 If you're only using one slot, don't let anything get into the empty slot, as both slots will be "live" when the lever is lowered.
- 9 Don't cover the toaster, or put anything on top of it – you'll cause a fire hazard.
- 10 If bread gets jammed, unplug the toaster, let it cool, then carefully remove the bread. Don't use anything sharp, you'll damage the elements.
- 11 Don't toast sandwiches or buttered items, the filling or spread may burn.
- 12 Don't use torn, curled up, oversized, or misshapen slices of bread, as these may jam the toaster.
- 13 Unplug the toaster when not in use, before moving and before cleaning. Let it cool down fully before cleaning and storing away.
- 14 Clean the crumbs out of your toaster frequently, to avoid a build up of crumbs. This is unhygienic, and could cause a fire hazard.
- 15 Don't use the toaster unless the crumb tray is fitted and closed.
- 16 Don't connect the toaster to an external timer or remote control system.
- 17 Keep the toaster and cable away from sources of heat.
- 18 Don't use the toaster for any purpose other than those described in these instructions.
- 19 Don't use the toaster if it's damaged or malfunctions.
- 20 If the cable is damaged, return the toaster, to avoid hazard.

household use only

before using for the first time

- Check the slots are empty.
- Set the browning control to the highest setting (6).
- Operate the toaster without bread, to cure the new elements.
- They may smoke a bit, but it's nothing to worry about – ensure the room is well ventilated.

toasting bread

- 1 Sit the toaster upright on a stable, level, heat-resistant surface.
- 2 Don't put it on or near anything that could be damaged even by moderate heat.
- 3 Route the cable so it doesn't overhang, and can't be tripped over or caught.
- 4 Bread may burn. Don't use the toaster near or below curtains or other combustible materials and watch it while it's hot.
- 5 Put the plug into the power socket (switch the socket on, if it's switchable).
- 6 Turn the browning control to the required setting (1 = light, 6 = dark).
- 7 Put bread into the toasting slots (maximum thickness 25mm (1in)).
- 8 Press the lever down fully – it won't lock down unless the toaster is connected to the electricity supply.
- 9 The  light will glow, and the elements will heat up.
- 10 When it's done, the toast will pop up, the light and the elements will go off.



extra lift

- 11 After toasting small items (bagels, crumpets, etc.) the bread carriage handle may be raised further, to allow them to be removed more easily.



eject

- 12 To stop the toaster before it's finished, press the  button.
- 13 The toast will pop up, the light and the elements will go off.



frozen bread

- 14 This takes the guesswork out of toasting frozen bread.
- 15 Leave the browning control at your favoured setting, insert the frozen bread, lower the lever, then press the  button.
- 16 The  light will glow, and the toasting time will be altered automatically to give the same degree of browning you get with unfrozen bread.

reheating toast

- 17 Leave the browning control at your favoured setting, insert the bread, lower the lever, then press the  button.
- 18 The  light will glow, the toast will be given a short burst of heat, then it'll pop up, and the light will go out.
- 19 You must only reheat plain, "unbuttered" toast.

bagel

- 20 Conventionally, only the brown crusty surfaces of bagels are toasted; the soft inner surfaces are just warmed, not browned.
- 21 Split your bagel, and put the two halves into the slots with the brown crusts facing the outside elements.
- 22 Leave the browning control at your favoured setting, press the lever fully down, then press the  button.
- 23 The  light will glow, the brown outsides of the bagel will be toasted, and the cut sides will be warmed.

-  If you're not conventional, and prefer your bagels toasted on the cut side, feel free to put them into the slots the other way round – we won't tell anyone!

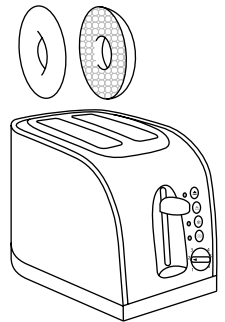

hints and tips

- 24 When toasting more than one slice, use slices of similar size, thickness and freshness.
- 25 Old (yesterday's) bread contains less moisture, so makes crisper toast.
- 26 Old or thin bread cooks faster than fresh or thick bread – use a lighter setting.
- 27 Sweet bread products (tea cakes, fruit loaf, etc.) brown much more quickly than ordinary bread, so should be toasted on a lighter setting.

crumbs

- 28 Clean the crumbs out of your toaster frequently, to avoid a build up of crumbs. This is unhygienic, and it could cause a fire hazard.
- 29 Unplug the toaster and let it cool down.
- 30 Slide the crumb tray out from underneath the toaster.
- 31 Empty it, wipe it with a damp cloth, dry it, then replace it in the toaster.
- 32 Don't use the toaster unless the crumb tray is fitted and closed.

care and maintenance

- 33 Unplug the toaster and let it cool.
- 34 Wipe outer surfaces with a damp cloth. If necessary, use a little washing-up liquid.
- 35 Don't let anything enter the slots, you might damage the elements.
- 36 Don't put the toaster in liquid.
- 37 Don't use harsh or abrasive cleaning agents or solvents.

connection

The product must be earthed. It has a 13A BS1362 fuse in a 13A BS1363 plug. To replace the plug, fit the green/yellow wire to ⊕ or E, the blue wire to N, and the brown wire to L. Fit the cord grip. If in doubt, call an electrician. Don't use a non-rewireable plug unless the fuse cover is in place. If you remove the plug, dispose of it.

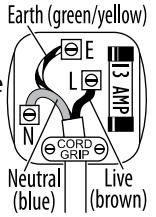

wheelie bin symbol

To avoid environmental and health problems due to hazardous substances in electrical and electronic goods, appliances marked with this symbol mustn't be disposed of with unsorted municipal waste, but recovered, reused, or recycled.



service

If you ring Customer Service, please have the **Model No.** to hand, as we won't be able to help you without it. It's on the rating plate (usually underneath the product).

The product isn't user-serviceable. If it's not working, read the instructions, check the plug fuse and main fuse/circuit breaker. If it's still not working, consult your retailer.

If that doesn't solve the problem – ring Customer Service – they may be able to offer technical advice.

If they advise you to return the product to us, pack it carefully, include a note with your name, address, day phone number, and what's wrong. If under guarantee, say where and when purchased, and include proof of purchase (till receipt). Send it to:

Customer Service, Russell Hobbs Ltd, Fir Street, Failsworth, Manchester M35 0HS

email: service@russellhobbs.com

telephone: 0845 658 9700 (local rate number)

guarantee

Defects affecting product functionality appearing within one year of purchase will be corrected by replacement or repair provided the product is used and maintained in accordance with the instructions. Your statutory rights are not affected.

Documentation, packaging, and product specifications may change without notice.

online

www.russellhobbs.co.uk for more products