

WORX

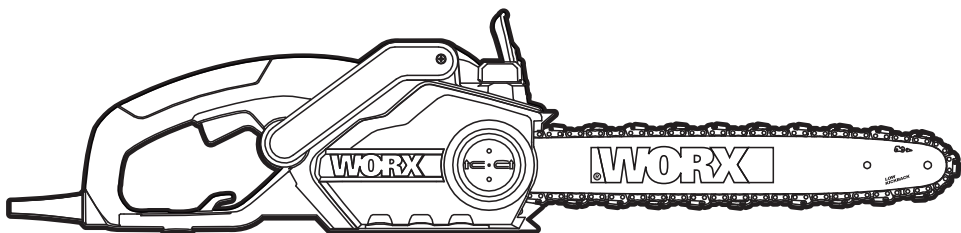

SAFETY AND OPERATING MANUAL

ORIGINAL INSTRUCTIONS

Chain Saw

WG303E

GENERAL POWER TOOL SAFETY WARNINGS



WARNING: Read all safety warnings and all instructions.

Failure to follow the warnings and instructions may result in electric shock, fire and/or serious injury.

Save all warnings and instructions for future reference.

The term "power tool" in the warnings refers to your mains-operated (corded) power tool or battery-operated (cordless) power tool.

1) Work area safety

a) Keep work area clean and well lit.

Cluttered or dark areas invite accidents.

b) Do not operate power tools in explosive atmospheres, such as in the presence of flammable liquids, gases or dust.

Power tools create sparks which may ignite the dust or fumes.

c) Keep children and bystanders away while operating a power tool.

Distractions can cause you to lose control.

2) Electrical safety

a) Power tool plugs must match the outlet. Never modify the plug in any way. Do not use any adapter plugs with earthed (grounded) power tools.

Unmodified plugs and matching outlets will reduce risk of electric shock.

b) Avoid body contact with earthed or grounded surfaces, such as pipes, radiators, ranges and refrigerators.

There is an increased risk of electric shock if your body is earthed or grounded.

c) Do not expose power tools to rain or wet conditions. Water entering a power tool will increase the risk of electric shock.

d) Do not abuse the cord. Never use the cord for carrying, pulling or unplugging the power tool. Keep cord away from heat, oil, sharp edges or moving parts. Damaged or entangled cords increase the risk of electric shock.

e) When operating a power tool outdoors, use an extension cord suitable for outdoor use. Use of a cord

suitable for outdoor use reduces the risk of electric shock.

f) If operating a power tool in a damp location is unavoidable, use a residual current device (RCD) protected supply. Use of an RCD reduces the risk of electric shock.

3) Personal safety

a) Stay alert, watch what you are doing and use common sense when operating a power tool. Do not use a power tool while you are tired or under the influence of drugs, alcohol or medication. A moment of inattention while operating power tools may result in serious personal injury.

b) Use personal protective equipment. Always wear eye protection.

Protective equipment such as dust mask, non-skid safety shoes, hard hat, or hearing protection used for appropriate conditions will reduce personal injuries.

c) Prevent unintentional starting. Ensure the switch is in the off-position before connecting to power source and/or battery pack, picking up or carrying the tool. Carrying power tools with your finger on the switch or energising power tools that have the switch on invites accidents.

d) Remove any adjusting key or wrench before turning the power tool on. A wrench or a key left attached to a rotating part of the power tool may result in personal injury.

e) Do not overreach. Keep proper footing and balance at all times. This enables better control of the power tool in unexpected situations.

f) Dress properly. Do not wear loose clothing or jewellery. Keep your hair, clothing and gloves away from moving parts. Loose clothes, jewellery or long hair can be caught in moving parts.

g) If devices are provided for the connection of dust extraction and collection facilities, ensure these are connected and properly used. Use of

dust collection can reduce dust-related hazards.

4) Power tool use and care

- a) Do not force the power tool. Use the correct power tool for your application.** The correct power tool will do the job better and safer at the rate for which it was designed.
- b) Do not use the power tool if the switch does not turn it on and off.**
Any power tool that cannot be controlled with the switch is dangerous and must be repaired.
- c) Disconnect the plug from the power source and/or the battery pack from the power tool before making any adjustments, changing accessories, or storing power tools.** Such preventive safety measures reduce the risk of starting the power tool accidentally.
- d) Store idle power tools out of the reach of children and do not allow persons unfamiliar with the power tool or these instructions to operate the power tool.** Power tools are dangerous in the hands of untrained users.
- e) Maintain power tools. Check for misalignment or binding of moving parts, breakage of parts and any other condition that may affect the power tool's operation. If damaged, have the power tool repaired before use.** Many accidents are caused by poorly maintained power tools.
- f) Keep cutting tools sharp and clean.** Properly maintained cutting tools with sharp cutting edges are less likely to bind and are easier to control.
- g) Use the power tool, accessories and tool bits etc. in accordance with these instructions, taking into account the working conditions and the work to be performed.** Use of the power tool for operations different from those intended could result in a hazardous situation.

5) Service

- a) Have your power tool serviced by a qualified repair person using only identical replacement parts.** This will ensure that the safety of the power tool is maintained.

CHAIN SAW SAFETY WARNINGS

- 1. Keep all parts of the body away from the saw chain when the chain saw is operating. Before you start the chain saw, make sure the saw chain is not contacting anything.** A moment of inattention while operating chain saws may cause entanglement of your clothing or body with the saw chain.
- 2. Always hold the chain saw with your right hand on the rear handle and your left hand on the front handle.** Holding the chain saw with a reversed hand configuration increases the risk of personal injury and should never be done.
- 3. Hold the power tool by insulated gripping surfaces only, because the saw chain may contact hidden wiring or its own cord.** Saw chains contacting a "live" wire may make exposed metal parts of the power tool "live" and could give the operator an electric shock.
- 4. Wear safety glasses and hearing protection. Further protective equipment for head, hands, legs and feet is recommended.** Adequate protective clothing will reduce personal injury by flying debris or accidental contact with the saw chain.
- 5. Do not operate a chain saw in a tree.** Operation of a chain saw while up in a tree may result in personal injury.
- 6. Always keep proper footing and operate the chain saw only when standing on fixed, secure and level surface.** Slippery or unstable surfaces such as ladders may cause a loss of balance or control of the chain saw.
- 7. When cutting a limb that is under tension be alert for spring back.** When the tension in the wood fibres is released the spring loaded limb may strike the operator and/or throw the chain saw out of control.

8. Use extreme caution when cutting brush and saplings. The slender material may catch the saw chain and be whipped toward you or pull you off balance.

9. Carry the chain saw by the front handle with the chain saw switched off and away from your body. When transporting or storing the chain saw always fit the guide bar cover. Proper handling of the chain saw will reduce the likelihood of accidental contact with the moving saw chain.

10. Follow instructions for lubricating, chain tensioning and changing accessories. Improperly tensioned or lubricated chain may either break or increase the chance for kickback.

11. Keep handles dry, clean, and free from oil and grease. Greasy, oily handles are slippery causing loss of control.

12. Cut wood only. Do not use chain saw for purposes not intended. For example: do not use chain saw for cutting plastic, masonry or non-wood building materials. Use of the chain saw for operations different than intended could result in a hazardous situation.

13. Using of a residual current device with a tripping current of 30 mA or less is recommended.

Causes and operator prevention of kickback

Kickback may occur when the nose or tip of the guide bar touches an object, or when the wood closes in and pinches the saw chain in the cut.

Tip contact in some cases may cause a sudden reverse reaction, kicking the guide bar up and back towards the operator. Pinching the saw chain along the top of the guide bar may push the guide bar rapidly back towards the operator.

Either of these reactions may cause you to lose control of the saw which could result in serious personal injury. Do not rely exclusively upon the safety devices built into your saw. As a chain saw user, you should

take several steps to keep your cutting jobs free from accident or injury. Kickback is the result of tool misuse and/or incorrect operating procedures or conditions and can be avoided by taking proper precautions as given below:

- **Maintain a firm grip, with thumbs and fingers encircling the chain saw handles, with both hands on the saw and position your body and arm to allow you to resist kickback forces.** Kickback forces can be controlled by the operator, if proper precautions are taken. Do not let go of the chain saw.
- **Do not overreach and do not cut above shoulder height.** This helps prevent unintended tip contact and enables better control of the chain saw in unexpected situations.
- **Only use replacement bars and chains specified by the manufacturer.** Incorrect replacement bars and chains may cause chain breakage and/or kickback.
- **Follow the manufacturer's sharpening and maintenance instructions for the saw chain.** Decreasing the depth gauge height can lead to increased kickback.

SAVE THESE INSTRUCTIONS **Instructions concerning the proper techniques for basic felling, limbing, and cross-cutting**

1. Felling a tree

When bucking and felling operations are being performed by two or more persons at the same time, the felling operations should be separated from the bucking operation by a distance of at least twice the height of the tree being felled. Trees should not be felled in a manner that would endanger any person, strike any utility line or cause any property damage. If the tree does make contact with any utility line, the company should be notified immediately.

The chain saw operator should keep on the uphill side of the terrain as the tree is likely to roll or slide downhill after it is felled.

An escape path should be planned and cleared as necessary before cuts are started. The escape path should extend back and

diagonally to the rear of the expected line of fall as illustrated in Figure 1.

Before felling is started, consider the natural lean of the tree, the location of larger branches and the wind direction to judge which way the tree will fall.

Remove dirt, stones, loose bark, nails, staples and wire from the tree.

2. Notching undercut

Make the notch 1/3 the diameter of the tree, perpendicular to the direction of falls as illustrated in Figure 1. Make the lower horizontal notching cut first. This will help to avoid pinching either the saw chin or the guide bar when the second notch is being made.

3. Felling back cut

Make the felling back cut at least 50 mm higher than the horizontal notching cut as illustrated in Figure 1. Keep the felling back cut parallel to the horizontal notching cut. Make the felling back cut so enough wood is left to act as a hinge. The hinge wood keeps the tree from twisting and falling in the wrong direction. Do not cut through the hinge

As the felling gets close to the hinge, the tree should begin to fall. If there is any chance that the tree may not fall in desired direction or it may rock back and bind the saw chain, stop cutting before the felling back cut is complete and use wedges of wood, plastic or aluminium to open the cut and drop the tree along the desired line of fall.

When the tree begins to fall remove the chain saw from the cut, stop the motor, put the chain saw down, then use the retreat path planned. Be alert for overhead limbs falling and watch your footing.

4. Limbing a tree

Limbing is removing the branches from a fallen tree. When limbing leave larger lower limbs to support the log off the ground. Remove the small limbs in one cut as illustrated in Figure 2. Branches under tension should be cut from the bottom up to avoid binding the chain saw.

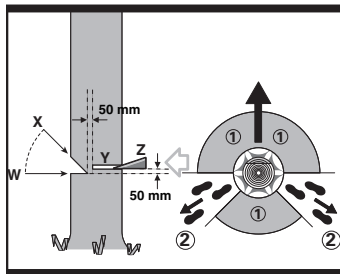

Fig.1

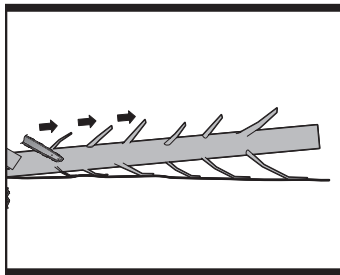

Fig.2

5. Bucking a log

Bucking is cutting a log into lengths. It is important to make sure your footing is firm and your weight is evenly distributed on both feet. When possible, the log should be raised and supported by the use of limbs, logs or chocks. Follow the simple directions for easy cutting.

When the log is supported along its entire length as illustrated in Figure 3, it is cut from the top (overbuck).

When the log is supported on one end, as illustrated in Figure 4, cut 1/3 the diameter from the underside (underbuck). Then make the finished cut by overbucking to meet the first cut.

When the log is supported on both ends, as illustrated in Figure 5, cut 1/3 the diameter from the top (overbuck). Then make the finished cut by underbucking the lower 2/3 to meet the first cut.

When bucking on a slope always stand on the uphill side of the log, as illustrated in Figure 6. When “cutting through”, to maintain complete control release the cutting pressure near the end of the cut without relaxing your grip on the chain saw handles. Don't let the chain contact the ground. After completing the cut, wait for the saw chain to stop before you move the chain saw. Always stop the motor before moving from tree to tree.

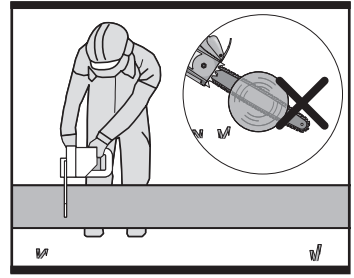

Fig.3

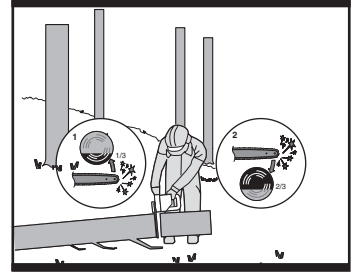

Fig.4

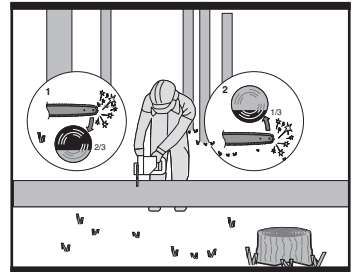

Fig.5

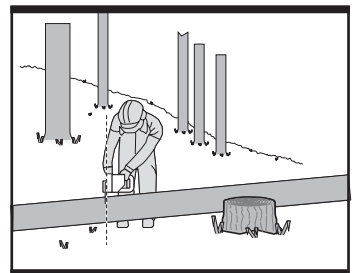

Fig.6

SYMBOLS



Read the manual



WARNING



Wear eye protection



Wear ear protection



Wear dust mask



Gloves with saw protection



Boots with saw protection, steel toe-cap and non-slip sole



Correct Direction of Cutting-Teeth



Chain stop



Tip contact may cause the guide bar to move suddenly upward and backwards, which may cause serious injury to user.



Contact of the guide bar tip with any object should be avoided



Do not use one handed when operating the chain saw.



Always use two hands when operating the chain saw.



Double insulation.



Do not expose to rain



Remove plug from the mains immediately if the cable is damaged or cut.



Waste electrical products must not be disposed of with household waste. Please recycle where facilities exist. Check with your local authorities or retailer for recycling advice.

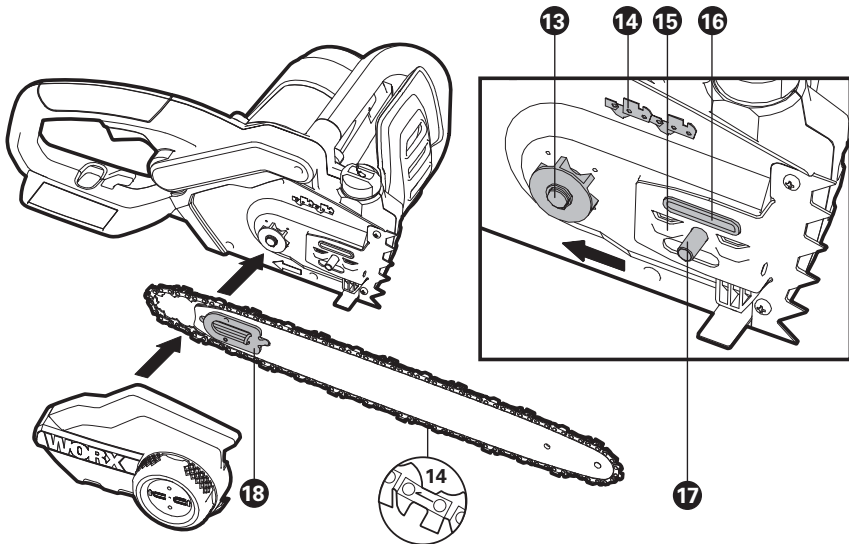
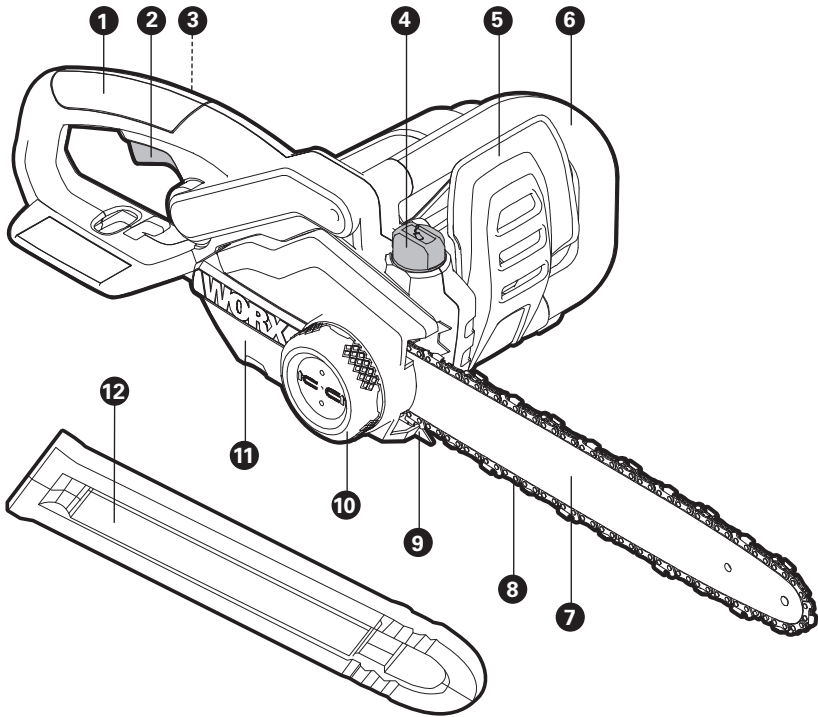

-
- 1. REAR HANDLE**

 - 2. ON/OFF SWITCH**

 - 3. LOCK-OFF BUTTON**

 - 4. OIL FILLER CAP**

 - 5. ACTIVATION LEVER FOR KICKBACK BRAKE(HAND GUARD)**

 - 6. FRONT HANDLE**

 - 7. GUIDE BAR**

 - 8. CHAIN**

 - 9. SPIKED BUMPER**

 - 10. LOCKING KNOB/ CHAIN TENSIONING ADJUSTMENT KNOB**

 - 11. COVER PLATE**

 - 12. BLADE PROTECTION COVER**

 - 13. DRIVE SPROCKET**

 - 14. SYMBOL FOR ROTATION AND CUTTING DIRECTION**

 - 15. GUIDE FINS FOR CHAIN BAR**

 - 16. OIL OUTLET**

 - 17. FASTENING BOLT**

 - 18. CHAIN TENSIONING CATCH**

 - 19. OIL LEVEL GAUGE(SEE FIG. H)**

 - 20. CHAIN CATCHER (SEE FIG. C2)**
-

Not all the accessories illustrated or described are included in standard delivery.

TECHNICAL DATA

Type **WG303E** (3- designation of machinery, representative of Chain Saw)

Voltage	220-240V~50/60Hz
Rated power	2000W
Bar length	400mm
Chain speed	12m/s
Oil tank capacity	200ml
Chain pitch	3/8"
Number of chain links	57
Chain gauge	0.05"
Saw chain type	ES:91VG
Bar type	ES:160SDEA041
Weight (chain & bar included)	4.8kg
Protection class	

NOISE DATA

A weighted sound pressure	L_{pA} : 93dB(A)
A weighted sound power	L_{WA} : 105dB(A)
K_{pA} & K_{WA}	3dB(A)
Wear ear protection	

Vibration Information

Vibration total values (triax vector sum) determined according to EN 60745	
Vibration emission value	a_h = 5.2 m/s ²
Uncertainty	K = 1.5 m/s ²

The declared vibration total value may be used for comparing one tool with another, and may also be used in a preliminary assessment of exposure.

 **WARNING:** The vibration emission value during actual use of the power tool can differ from the declared value depending on the ways in which the tool is used dependant on the following examples and other variations on how the tool is used:

How the tool is used and the materials being cut or drilled.

The tool being in good condition and well maintained

Using the correct accessory for the tool and ensuring it is sharp and in good condition.

The tightness of the grip on the handles and if any anti vibration accessories are used.

And the tool is being used as intended by its design and these instructions.

This tool may cause hand-arm vibration syndrome if its use is not adequately managed

 **WARNING:** To be accurate, an estimation of exposure level in the actual conditions of use should also take account of all parts of the operating cycle such as the times when the tool is switched off and when it is running idle but not actually doing the job. This may significantly reduce the exposure level over the total working period.

Helping to minimise your vibration exposure risk.

ALWAYS use sharp chisels, drills and blades.

Maintain this tool in accordance with these instructions and keep well lubricated (where appropriate).

If the tool is to be used regularly then invest in anti vibration accessories.

Avoid using tools in temperatures of 10°C or less.

Plan your work schedule to spread any high vibration tool use across a number of days.

ACCESSORIES

Lubrication oil	100ml
Blade protection cover	1
Chain	1
Bar	1

We recommend that you purchase your accessories from the same store that sold you the tool. Refer to the accessory packaging for further details. Store personnel can assist you and offer advice.

Intended use

The chain saw is intended for sawing of trees, tree trunks, branches, wooden beams, planks, etc. Cuts can be sawed with or across the grain. This product is not suitable for sawing mineral materials.

ASSEMBLY

WARNING! Do not connect the chain saw to mains before it is completely assembled. Always use gloves when handling the chain.

CHAIN AND GUIDE BAR ASSEMBLY

1. Unpack all parts carefully.
2. Place the chain saw on a solid, level surface.
3. Use only genuine WORX chains designed for chainbar.
4. Slide the chain (8) in the slot around the chain bar (7). Ensure chain is in correct running direction by comparing with chain symbol (14). Ensure the chain tensioning catch (18) is facing outwards. (See Fig. A)
5. Fit the chain onto the drive sprocket (13) and guide the chain bar (7), so that the fastening bolt (17) and the two guide fins (15) fit into the keyway of the chain bar (7). (See Fig. B)
6. Check if all parts are seated properly and hold chain and chain bar in a level position. (See Fig. C1)
7. Fit cover plate, ensure that the chain catcher (20) fits into the groove of the cover plate (11). (See Fig. C2)
8. Screw on the cover plate (11) with the locking knob (10). (See Fig. D)

The chain is not yet tensioned. Tensioning the chain applies as described under "Tensioning chain".

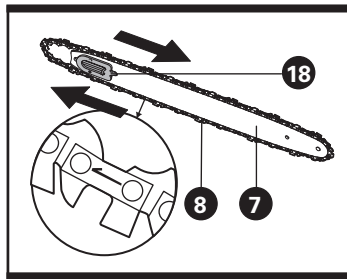

A

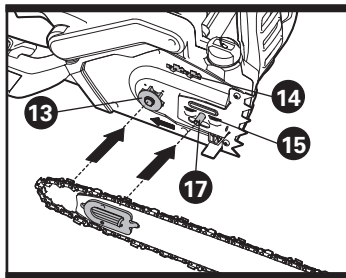

B

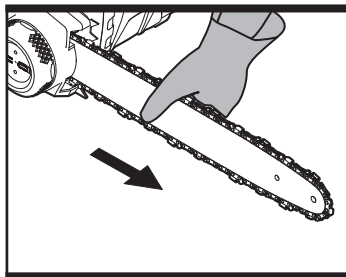

C1

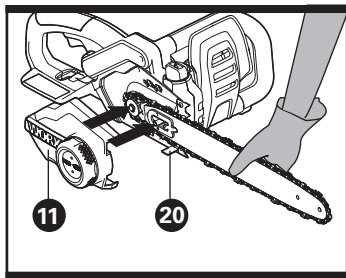

C2

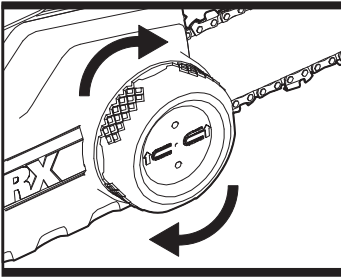

D

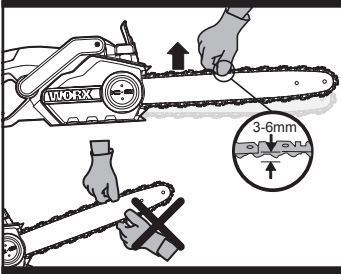

E1

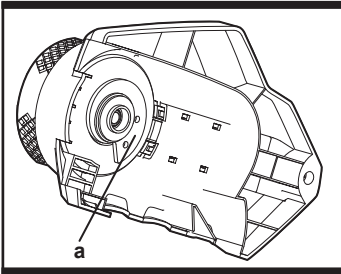

E2

TENSIONING CHAIN

Always check the chain tension before use, after the first cuts and regularly during use, approx. every 10 minutes. Upon initial operation, new chains can lengthen considerably.



WARNING: Unplug chain saw from power source before adjusting saw chain tension.



WARNING: Cutting edges on chain are sharp.



WARNING: Use protective gloves when handling chain.

WARNING: Maintain proper chain tension

always. A loose chain will increase the risk of kickback. A loose chain may jump out of guide bar groove. This may injure operator and damage chain. A loose chain will cause chain, chain bar, and sprocket to wear rapidly.

The chain life of the saw chain mainly depends upon sufficient lubrication and correct tensioning. Avoid tensioning the chain if it is hot, as this will cause the chain to become over tensioned when it cools down.

1. Place the chain saw on any suitable flat surface.
2. Turn the locking knob/ chain tensioning knob (10) clockwise until the locking knob is screwed tightly. The correct chain tension will be reached automatically. The ratchet mechanism prevents the chain tension from loosening. (See Fig. E2)
3. The correct chain tension is reached when the chain (8) can be raised approx. 3 – 6 mm from the chain bar in the centre. This should be done by using one hand to raise the chain against the weight of the machine. (See Fig. E1)
4. When the chain looses, unscrew the locking knob/ chain tensioning knob absolutely and then Screw on the cover plate with the locking knob tightly again.

13

LUBRICATION



IMPORTANT: the chain saw is not supplied filled with oil. It is essential to fill with oil before use. Never operate the chain saw without chain oil or at an empty oil tank level, as this will result in extensive damage to the product.

Chain life and cutting capacity depend on optimum lubrication. Therefore, the chain is automatically oiled during operation via oil outlet (16).

FILLING OIL TANK:

1. Set chain saw on any suitable surface with oil filler cap facing upward.
2. Clean area around the oil filler cap with cloth unscrew cap.
3. Add **WORX** chain saw oil until reservoir is full.

4. Avoid dirt or debris entering oil tank, refit oil filler cap (4) and tighten.

! **IMPORTANT:** To allow venting of the oil reservoir, small breather channels are provided between the oil filler cap and the strainer, to prevent leakage ensure machine is left in a horizontal position (oil filler cap (4) uppermost) when not in use. It is important to use only the recommended oil to avoid damage to the chain saw. Never use recycled/old oil. Use of non approved oil will invalidate the warranty.

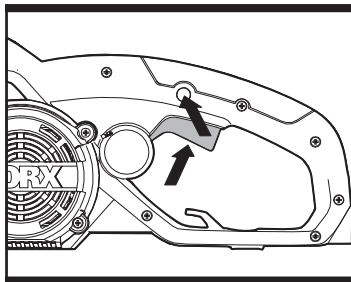

F

OPERATION

1. SWITCHING ON AND OFF (See Fig. F)

! **ATTENTION:** Check the voltage and current supply: The voltage and current supply must comply with the ratings on the type plate.

For **switching on the machine**, press the lock-off (3) button, then fully press the on/off switch (2) and hold in this position. The lock-off button (3) can now be released.

For **switching off**, release the on/off switch (2).

Do not stop chain saw after sawing by activating the front hand guard (chain brake).

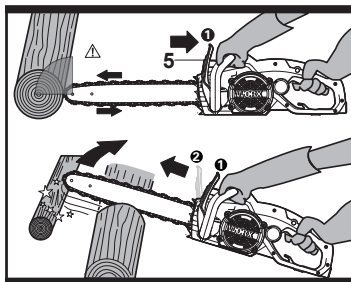

G

2. CHAIN BRAKE (SEE FIG. G)

The **chain brake** is a safety mechanism activated through the front hand guard (5), when kickback occurs. Chain stops immediately.

The following function check should be carried out at regular intervals. Push front hand guard (5) forwards (position ②) and start the chain saw. The chain must not start. To deactivate the kickback brake, pull hand guard (5) backwards (position ①), and release On/Off switch (2)

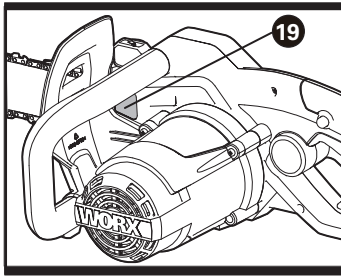

H

CUTTING

- is the oil reservoir filled? Check oil level gauge (19) prior to starting and regularly during operation. Refill oil when oil level is low. The oil tank filling will last approx. 16 minutes, depending on sawing intensity and stops. (See Fig. H)
- is the chain tension in order and is the chain sharp? Check new replaced chain tension approx. every 10 minutes during operation. Upon initial operation, new chains can lengthen considerably. The condition of the chain influences the cutting performance. Only a sharp chain protects from overload.
- is the kickback deactivated and its function ensured?
- are you wearing the necessary protective equipment? Wear safety glasses /goggles/visor –safety helmet and hearing protection. Further protective equipment for head, hand, legs and feet is highly recommended. Adequate protective clothing will reduce personal injury by flying debris or accidental contact with saw chain.

Proper functioning of the automatic oiler can be checked by running the chain saw and pointing the tip of the chain bar towards a piece of cardboard or paper on the ground. Caution: Do not touch the ground with the chain. Ensure safety clearance of 20 cm. If an increasing oil pattern develops, the automatic oiler is operating fine. If there is no oil pattern, despite a full oil reservoir, see "Troubleshooting" or contact WORX customer service agent or approved service agent.

15

Kickback (See Fig. G)

Kickback is the sudden backward/upward motion of the chain saw, occurring when the chain (at the tip of the chain bar) comes in contact with a log or wood, or when the chain becomes jammed.

When kickback occurs the chainsaw reacts unpredictably and can cause severe injuries to the operator or bystanders.

Particular attention must be given when sawing sideward, slanted or during length cuts, as the spiked bumper usually can not be applied.

To avoid kickback:

- saw with guide bar at a flat angle.
- never work with a loose, widely stretched or the heavily worn out chain.
- ensure chain is sharpened correctly.
- never saw above shoulder height.
- never work with the tip of the guide bar.
- always hold the chain saw firmly with both hands.
- always use a low kickback chain.
- apply the metal gripping teeth for leverage.
- ensure correct chain tension.

General behavior

Always hold the chain saw firmly with both hands. Front grip with the left hand and rear grip with the right hand. Fully grip both handles at all times during operation. Never operate chain saw using only one hand. Ensure power cord is located to the rear, away from the chain and wood and so positioned that it will not be caught on branches or the like during cutting. (See Fig. G)

Use the chain saw only with secure footing. Hold the chain saw at the right-hand side of your body. (See Fig. I) The chain must be running at full speed before it makes contact with the wood. Use the metal gripping teeth to secure the saw onto the wood before starting to cut. Use the gripping teeth(9) as a leverage point "a" while cutting. (See Fig. J)

Reset the gripping teeth at a low point when sawing thicker logs by pulling the chain saw slightly backwards until the gripping teeth release, and reposition at lower level to continue sawing. Do not remove the saw completely from the wood.

Do not force the chain while cutting, let the chain do the work, using the gripping teeth to apply minimal leverage pressure.

Do not operate the chain saw with arms fully extended or attempt to saw areas which are difficult to reach, or on a ladder. Never use the chain saw above shoulder height. (See Fig. K)

Sawing is optimized when the chain speed remains steady during cutting.

Beware when reaching the end of the cut. The weight of the saw may change unexpectedly as it cuts free from the wood. Accidents can occur to the legs and feet.

Always remove the saw from a wood cut while the saw is running.

Cutting logs

Observe the following safety instructions:

Support logs so that the face sides at the cut do not close in against each other, which would result in the chain being jammed or pinched. (See Fig. I,L)

Position and set short logs safety prior to sawing. Saw only wood or wooden objects. When sawing, always take care to avoid hitting stones, nails, ect, as these could be thrown up or cause damage to the chain or serious injury to the operator or bystanders.

Keep a running saw clear of wire fencing or the ground. Use of the saw to thin out branches or bushes is not approved.

Length cuts must be carried out with care, as leverage with the gripping teeth(9) is not possible. Saw at a flat angle to avoid kickback.

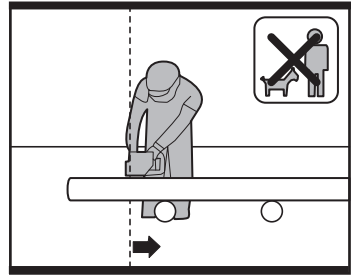

I

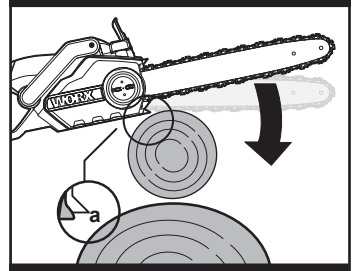

J

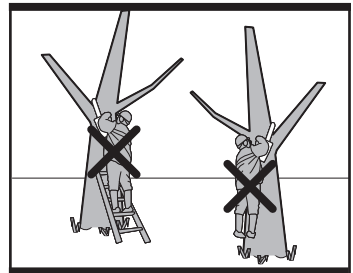

K

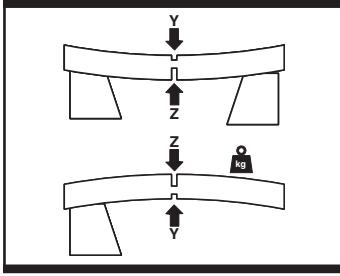

L

When working on a slope, operate above or to the side of the trunk or laying tree.

Be careful not to trip over tree stumps, branches, roots, etc.

CUTTING WOOD UNDER TENSION (SEE FIG. L)

There is a high risk of accidents when sawing wood, branch or trees under tension. Be extremely careful. Leave saw jobs like these to professionals.

When sawing logs supported on both ends, start the cut from above(Y) about 1/3 of the diameter into the log and then finish the cut (Z) from below, in order to avoid contact of the chain saw with the ground. When sawing logs supported on only one end, start the cut from below (Y) about 1/3 of the diameter into the log and finish the cut from above (Z) in order to avoid log splitting or jamming of the chain saw.

MAINTENANCE

Before any work on the machine itself, pull the mains plug from the socket.

NOTE: To ensure long and reliable service, carry out the following maintenance regularly.

Regularly check for obvious defects such as loose, dislodged or damaged chain and guide bar, loose fixings and worn or damaged components.

Check that covers and guards are undamaged and correctly fitted. Carry out necessary maintenance or repairs before using the chain saw.

If the chain saw should happen to fail despite the care taken in manufacturing and testing, repair should be carried out by an authorized customer service agent.

If the replacement of the supply cord is necessary, this has to be done by the manufacturer or his agent in order to avoid a safety hazard.

Before returning, ensure all oil in the oil tank has been emptied.

Replacing/Changing Chain and guide bar

Fit the chain and guide bar as described in "Assembly and Tensioning Chain"

The circular groove of the guide bar will wear particularly on the lower edge with time. When replacing the chain turn the chain bar 180° to allow even wear, thus extending chain bar life.

Check drive sprocket. If it is worn out or damaged due to strain, have it exchanged by an authorized service agent.

If the chain bar is worn out or damaged, take the chain tensioning catch off the bar by loosening the screw anti-clockwise. Then fit the tensioning catch into the new bar by tightening the screw clockwise. The catch protrude (a) must be fitted into the bar hole. (See Fig M)

Sharpening Chain

Have your chain sharpened professionally at your approved service agent or sharpen the chain yourself using the sharpening kit. Follow the sharpening instructions supplied with the sharpening kit.

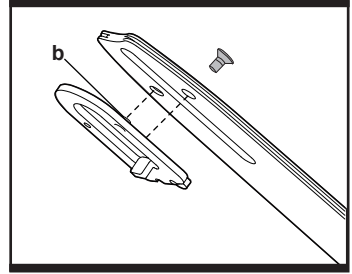

M

CLEANING/STORAGE

Clean the moulded plastic housing of the chain saw using a soft brush and clean cloth. Do not use water, solvents or polishes. Remove all debris, especially from the motor cooling vents.

Remove and brush clean the cover plate, chain and chain bar after 1 to 3 hours of use. Clean the area under the cover plate, the drive sprocket and chain bar assembly using a soft brush. Clean oil outlet with a clean cloth.

If the chain saw is to be stored for a longer period of time, clean chain and chain bar.

Store in a secure, dry place out of the reach of children.

Do not place other objects on the chain saw.

To prevent leakage ensure machine is left in a horizontal position (oil filler cap 4 uppermost).

When storing machine in original packaging the oil tank must be completely emptied.

TROUBLESHOOTING

Symptom	Possible	Cause
Chain saw fails to operate	Kickback brake is activated No power Mains socket faulty Extension cord damaged Fuse faulty	Pull hand guard back in position ① (Figure G) Check power Use another socket Check cord, replace Replace fuse
Chain saw operates intermittently	Extension cord damaged Loose connection Internal wiring defective On/Off switch defective	Check cord, replace Contact service agent Contact service agent Contact service agent
Dry chain	No oil in reservoir Vent in oil filler cap clogged Oil passage clogged	Refill oil Clean cap Clean oil passage outlet
Kickback Brake / Run down brake	Brake does not stop chain	Contact service agent
Chain/chain bar overheats	No oil in reservoir Vent in oil filler cap clogged Oil passage clogged Chain is over tensioned Dull chain	Refill oil Clean cap Clean oil passage outlet Adjust locking knob Sharpen chain or replace
Chain saw rips, vibrates, does not saw properly	Chain tension too loose Dull chain Chain worn out Chain teeth are facing in the wrong direction	Adjust locking knob Sharpen chain or replace Replace chain Reassemble with chain in correct direction

Never use tools with defective On/Off switches or defective Kickback brake(Hand Guard).
In the case of all other types of technical faults, please contact helpline or local service center.

ENVIRONMENTAL PROTECTION



Waste electrical products must not be disposed of with household waste. Please recycle where facilities exist. Check with your local authorities or retailer for recycling advice.

PLUG REPLACEMENT (ONLY FOR REWIRABLE PLUG OF UK & IRELAND)

If you need to replace the fitted plug then follow the instructions below.

IMPORTANT

The wires in the mains lead are colored in accordance with the following code:

Blue – Neutral

Brown – Live

As the colors of the wires in the mains lead of this appliance may not correspond with the coloured markings identifying the terminals in your plug, proceed as follows. The wire which is coloured blue must be connected to the terminal which is marked with N. The wire which is coloured brown must be connected to the terminal which is marked with L.

WARNING: Never connect live or neutral wires to the earth terminal of the plug. Only fit an approved 13ABS1363/A plug and the correct rated fuse.

NOTE: If a moulded plug is fitted and has to be removed take great care in disposing of the plug and severed cable, it must be destroyed to prevent engaging into a socket.

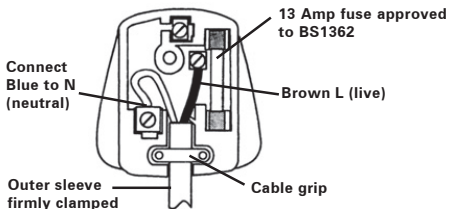

DECLARATION OF CONFORMITY

We,
Positec Power Tools (Europe) Ltd, PO Box 152,
Leeds, LS10 9DS, UK

Declare that the product,
Description

WORX Chain saw

Type **WG303E (3-designation of
machinery, representative of Chain Saw)**

Complies with the following Directives,
**2006/42/EC, 2004/108/EC, 2011/65/EU,
2000/14/EC amended by 2005/88/EC**

The notified body involved

Name: **Intertek Deutschland GmbH
(Notified body 0905)**

Address: **Stangenstraße 1, 70771
LEINFELDEN-ECHTERDINGEN**

Certification No.: **09SHW3034-04**

2000/14/EC amended by 2005/88/EC

– Conformity assessment procedure as per
Annex V

– Measured Sound Power Level **105 dB (A)**

– Declared Guaranteed Sound Power Level
108 dB (A)

Standards conform to:

**EN 60745-1, EN 60745-2-13, EN ISO
3744, EN 55014-1, EN 55014-2, EN
61000-3-2, EN 61000-3-3**

The person authorized to compile the technical
file,

Name Russell Nicholson

**Address Positec Power Tools (Europe)
Ltd, PO Box 152, Leeds, LS10 9DS, UK**



Suzhou 2015/12/08

Allen Ding

Deputy Chief Engineer, Testing & Certification

Chain Saw

WG303E

WORX
it's your nature

www.worx.com

Copyright © 2015, Positec. All Rights Reserved.
AR01166300