

Instructions for Installation and Use

60 cm Slot-in Cookers

GB

GB

English, 2

DSC60G
HUE63P
HAE60S
62DCW
62DCK
HAE60K S
HAE60P S
HAE60X S
HUE61G S
HUE61K S
HUE61P S
HUE61X S
60HEP S
62DCW S
DSC60S S
60HEG S
HAE60G S

Contents

WARNING, 2

Introduction, 3

Installation, 4

Safety Information, 5

Features, 6

The Controls, 7

Clock/Minute Minder Operation 8

Temperature Conversion Chart, 9

Use and Care of the Ceramic Hob, 10-11

Grill, 12

Solarplus Grill, 13

Top Oven Cookery Notes, 14

Main Oven Cookery Notes, 15

Oven Temperature Charts, 16-17

Using The Main Oven for other Functions, 18

Care and Cleaning, 19-22

Cooking Results Not Satisfactory?, 23

Something Wrong with your Cooker?, 24-25

Disposal of the product, 26

Guarantee Information, 27

Service Information, 28

 **Hotpoint**

Please phone us on
08448 24 24 24
to activate your
guarantee

WARNING

GB

WARNING: The appliance and its accessible parts become hot during use.

Care should be taken to avoid touching heating elements. Children less than 8 years of age shall be kept away unless continuously supervised.

This appliance can be used by children aged from 8 years and above and persons with reduced physical, sensory or mental capabilities or lack of experience and knowledge if they have been given supervision or instruction concerning use of the appliance in a safe way and understand the hazards involved. Children shall not play with the appliance. Cleaning and user maintenance shall not be made by children without supervision.

WARNING: Unattended cooking on a hob with fat or oil can be dangerous and may result in fire.

NEVER try to extinguish a fire with water, but switch off the appliance and then cover flame e.g. with a lid or a fire blanket.

WARNING: Danger of fire: do not store items on the cooking surfaces.

WARNING: If the surface in glass-ceramic is cracked, switch off the appliance to avoid the possibility of electric shock.

Do not use harsh abrasive cleaners or sharp metal scrapers to clean the oven door glass since they can scratch the surface, which may result in shattering of the glass.

The internal surfaces of the compartment (where present) may become hot.

Never use steam cleaners or pressure cleaners on the appliance. Remove any liquid from the lid before opening it.

Do not close the glass cover (if present) when the gas burners or electric hotplates are still hot.

To the Installer:

Before installation, fill in the product details on the back cover of this book.
The information can be found on the rating plate.

To the User:

You must read the instructions prior to installing and using the appliance and then retain them for future reference.

! Before operating your new appliance please read this instruction booklet carefully. It contains important information concerning the safe operation, installation and maintenance of the appliance.

! Please keep these operating instructions for future reference. Pass them on to possible new owners of the appliance.

Retention of this Instruction Book

This Instruction Book must be kept handy for reference as it contains important details on the safe and proper use of the appliance.

If you sell or pass the appliance to someone else, or move house and leave it behind, make sure this Book is also provided so the new owner can become familiar with the appliance and safety warnings. Your new appliance is guaranteed* and will give lasting service. This guarantee is only applicable if the appliance has been installed in accordance with the installation instructions detailed in this booklet. To help make best use of your cooking equipment, please read this booklet carefully.

The cooker is designed specifically for domestic use and responsibility will not be accepted for use in any other installation.

When the cooker is first used an odour may be emitted, this will cease after a period of use.

When first using the cooker ensure that the room is well ventilated (e.g. open a window or use an extractor fan) and that persons who may be sensitive to the odour avoid any fumes.

It is suggested that any pets be removed from the room until the smell has ceased. This odour is due to temporary finish on oven liners and elements and also any moisture absorbed by the insulation.

Your new cooker is guaranteed and will give lasting service.

The guarantee is only applicable if the cooker has been installed in accordance with the Installation Instructions.

The cooker is designed specifically for domestic use and responsibility will not be accepted for use in any other installation.

* The guarantee is subject to the provisions that the appliance:

- (a) Has been used solely in accordance with the Users Instruction Book.
- (b) Has been properly connected to a suitable supply voltage as stated on the rating plate attached to this equipment.
- (c) Has not been subjected to misuse or accident or been modified or repaired by any person other than the authorised employee or agent.
- (d) Has been correctly installed.

Our policy is one of continual improvement in design and development, therefore strict accuracy of illustrations and descriptions cannot be guaranteed.



This appliance conforms with the following European Economic Community directives:

- 2006/95/EC of 12/12/06 (Low Voltage) and subsequent modifications;
- 2004/108/EC of 15/12/04 (Electromagnetic Compatibility) and subsequent modifications;
- 90/396/EEC of 29/06/90 (Gas) and subsequent modifications (only for models which use gas);
- 93/68/EEC of 22/07/93 and subsequent modifications.
- 2002/96/EC
- 1275/2008 (Stand-by/ Off Mode)

Installation

GB

WARNING - THIS APPLIANCE MUST BE EARTHED.

Mains Connection

Your cooker should have been checked to ensure that the voltage corresponds with your supply voltage, this is stated on the rating plate, which is situated on the outer rear panel.

The model number and serial number are located on the front of the cooker, as shown on the Feature's page.

The cooker must be connected by a competent person such as one who is a, NICEIC registered contractor to a suitable double-pole control unit with a minimum rating of 32A and a minimum contact clearance of 3mm (applicable to newer properties, older properties where a 30A double pole control unit and a minimum contact clearance of 3mm is acceptable).

The double pole control unit should be fitted adjacent to the cooker, in accordance with IEE regulations. The control unit must be within 2 metres of but not directly above the appliance and should be easily accessible in the event of an emergency. The power supply cable should conform to B.S.6004 with a conductor size of 6mm², minimum.

Access to the mains terminals is gained by removing the rear access cover. The mains cable must pass through the cable clamp adjacent to the terminal block. Sufficient cable should be used to allow the cooker to be pulled out for servicing.

Ensure that the mains cable is routed away from any brackets affixed to the rear panel and is not trapped to the rear wall when pushing the cooker into position between cabinets.

Levelling

Four feet are fitted which can be adjusted up or down to set the height (900mm - 930mm) and level the cooker.

The feet can be simply screwed in or out to lower or raise the cooker.

After the correct height is achieved, lock the feet into position by tightening the locking nut using an open ended spanner.

CAUTION: Some soft floor coverings may get damaged if the cooker is not moved carefully.

NOTE: Ensure oven shelves are level by using a spirit level on the rod shelves.

Siting the Cooker

The cooker is designed to fit between kitchen cabinets spaced 600mm apart. The space either side need only be sufficient to allow withdrawal of the cooker for servicing and cleaning.

It can be used with cabinets one side or both as well

as in an angled corner setting. It can also be used freestanding.

Adjacent side walls which project above hob level, must not be nearer to the cooker than 150mm and should be protected by heat resistant material. Any overhanging surface or cooker hood should not be nearer than 650mm.

Note: This appliance must NOT be fitted on a platform.

Moving the Cooker

Before moving your cooker, switch off at the cooker control unit, ensure that it is cool.

Open the grill door sufficiently to allow a comfortable grip on the underside front edge of the oven roof, avoiding any grill elements.

Radio Interference

This appliance conforms to EN 55014 regarding suppression of radio and television interference.

Note: Take care in moving the cooker as it is heavy. Take care to ensure that any floor covering is not damaged.

Technical Characteristics

Top Oven

Usable Volume: 39 Litres
36 Litres for 60HEGS and 60HEPS

ENERGY LABEL - Top Oven

Directive 2002/40/EC on the label of electric ovens
Norm EN 50304

Declared energy consumption for
Natural convection Class

heating mode: Conventional

Main Oven

Usable Volume: 71 Litres

ENERGY LABEL - Main Oven

Directive 2002/40/EC on the label of electric ovens
Norm EN 50304

Declared energy consumption for
Natural convection Class

heating mode: Fan Oven

Voltage and Frequency

230-240V~ 50Hz

When used properly your appliance is completely safe but as with any electrical product there are certain precautions that must be observed. PLEASE READ THE PRECAUTIONS BELOW BEFORE USING YOUR APPLIANCE.

Always

- Remove all packing from the appliance before switching on for the first time.
- Understand the controls prior to using the appliance.
- Keep children away from the appliance when cooking as the surfaces will get extremely hot during and after use.
- Turn controls **off** when not in use.
- Stand back when opening an oven door to allow any build up of steam or heat to disperse.
- Always use dry good quality oven gloves when removing items from the oven/grill.
- Always place pans centrally over the hotplate making sure handles are kept away from the edge of the hob and cannot become heated by other hotplates or pans.
- Always take care to avoid heat or steam burns when operating the controls.
- Always turn off the electricity supply at the wall switch and allow the appliance to cool before cleaning (or changing an oven lamp if fitted).
- Always make sure the shelves are in the correct position before switching on the oven or grill.
- Always keep the oven/grill door closed when the appliance is not in use.
- Always keep the appliance clean as a build up of grease or fat from cooking can cause a fire.
- Always follow the basic principles of food handling and hygiene to prevent the possibility of bacterial growth.
- Always keep ventilation slots clear of obstructions.
- Always refer servicing to a qualified appliance service engineer.
- Always take care when removing items from the grill compartment when the lower oven is in use as the contents will be hot.
- Always turn off the electricity supply to the appliance at the wall switch should any glass panel (if fitted) crack or shatter and then **DO NOT USE THE APPLIANCE** until repaired.
- During use, the oven becomes hot. Care should be taken to avoid touching heating elements inside the oven.
- The appliance must be used by adults only for the preparation of food, in accordance with the instructions outlined in this booklet. Any other use of the appliance (e.g. for heating the room) constitutes improper use and is dangerous. The manufacturer may not be held liable for any damage resulting from improper, incorrect and unreasonable use of the appliance.

Never

- Never stare at Halogen heating units.
- Never leave children unsupervised where a cooking appliance is installed as all surfaces will be hot during and after its use.
- Never allow anyone to sit or stand on any part of the appliance.
- Never store items above the appliance that children may attempt to reach.
- Never leave anything on the hob surface when unattended and not in use.
- Never remove the oven shelves whilst the oven is hot.
- Never heat up unopened food containers as pressure can build up causing the container to burst.
- Never store chemicals/food stuffs or pressurised containers in or on the

- appliance, or in cabinets immediately above or next to the appliance.
- Never place flammable or plastic items on or near the hob.
- Never fill a deep fat frying pan more than 1/3 full of oil, or use a lid. **DO NOT LEAVE DEEP FAT FRYING PANS UNATTENDED WHILE COOKING.**
- Never use the appliance as a room heater.
- Never use the grill to warm plates.
- Never dry any items on either the hob or oven doors.
- Never install the appliance next to curtains or other soft furnishings.
- Never operate the grill with the grill door closed as this will cause the appliance to over heat.
- Never use 'steam cleaners'.

SAFETY ADVICE IN CASE OF A CHIP-PAN FIRE

In the event of a chip pan fire or any other pan fire.

- TURN OFF THE COOKER APPLIANCE AT THE WALL SWITCH.
- COVER THE PAN WITH A FIRE BLANKET OR DAMP CLOTH, this will smother the flames and extinguish the fire.
- LEAVE THE PAN TO COOL FOR AT LEAST 60 MINUTES BEFORE MOVING IT. Injuries are often caused by picking up a hot pan and rushing outside with it.

NEVER USE A FIRE EXTINGUISHER TO PUT OUT A PAN FIRE as the force of the extinguisher is likely to tip the pan over.

Never use water to extinguish oil or fat fires.

! The appliance should not be operated by people (including children) with reduced physical, sensory or mental capacities, by inexperienced individuals or by anyone who is not familiar with the product. These individuals should, at the very least, be supervised by someone who assumes responsibility for their safety or receive preliminary instructions relating to the operation of the appliance.

NOTICE

! VERY HOT SURFACES

FOOD OR GREASE ON THESE SURFACES COULD CAUSE SMOKE AND POSSIBLY EVEN BURN YOU MUST KEEP THE OVEN AND GRILL CAVITIES CLEAN

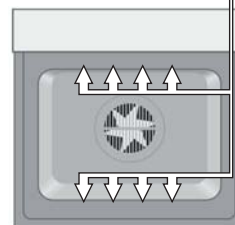

! ATTENTION

DURING INSTALLATION THE FEET OF THE APPLIANCE MUST BE LOWERED SO THAT AN AIR GAP OF AT LEAST 10MM (1CM) IS LEFT BETWEEN THE BASE OF THE APPLIANCE AND THE FLOOR.



! ATTENTION

WHEN USING THE MAIN OVEN YOU MUST ENSURE THAT THE BASE OF THE CAVITY IS NOT COVERED WITH ALUMINUM FOIL, UTENSIL OR ANY OTHER FORM OF COVERING. FAILURE TO DO THIS MAY RESULT IN THE CAVITY BEING DAMAGED.



Features

GB

1800/750W Dual Circuit (HUE61G S HUE61K S HUE61P S HUE61X S HAE60K S HAE60P S HAE60X S HAE60G S HAE60G S)
 1800W Ceramic (All other models)
 1800W Halogene (HUE63P) 1200W Ceramic

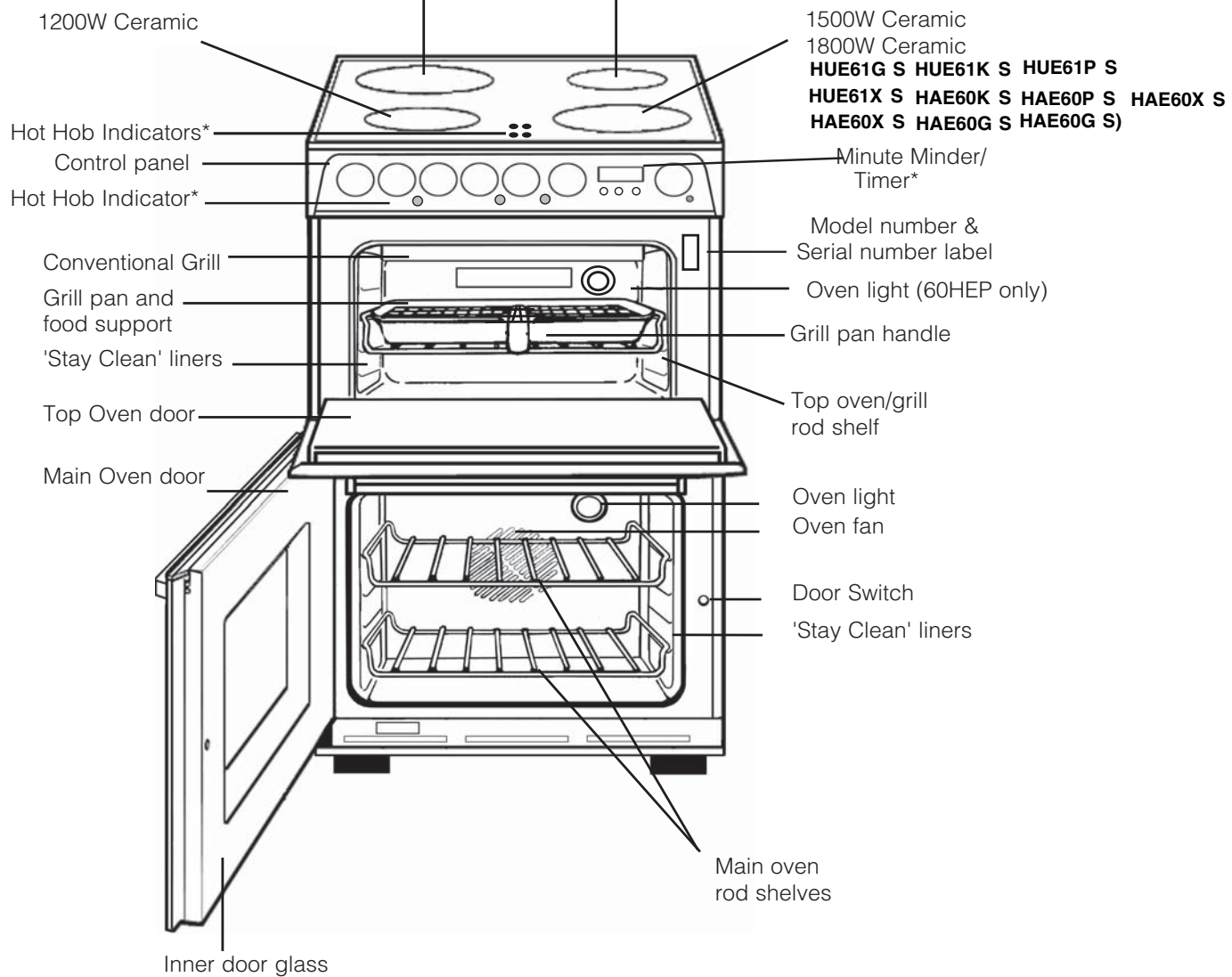

* Available only in certain models

The controls

60HEP; 62DCW; DSC60G;DSC60S; HUE63P;62DCK;60HEG

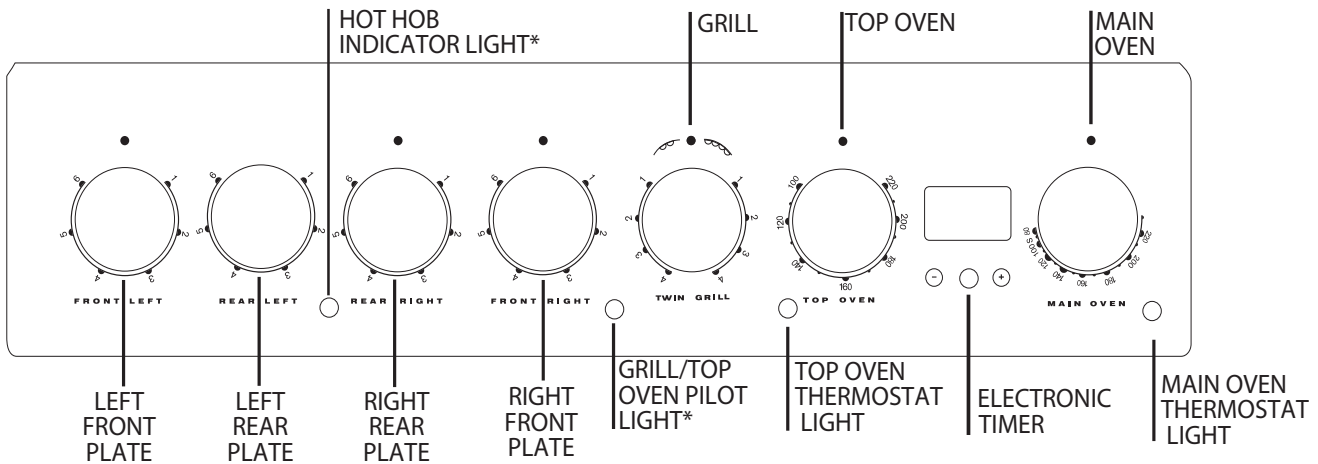

HUE61G;HUE61K; HUE61P;HUE61X;HAE60K;HAE60P;HAE60G;HAE60S;HAE60X

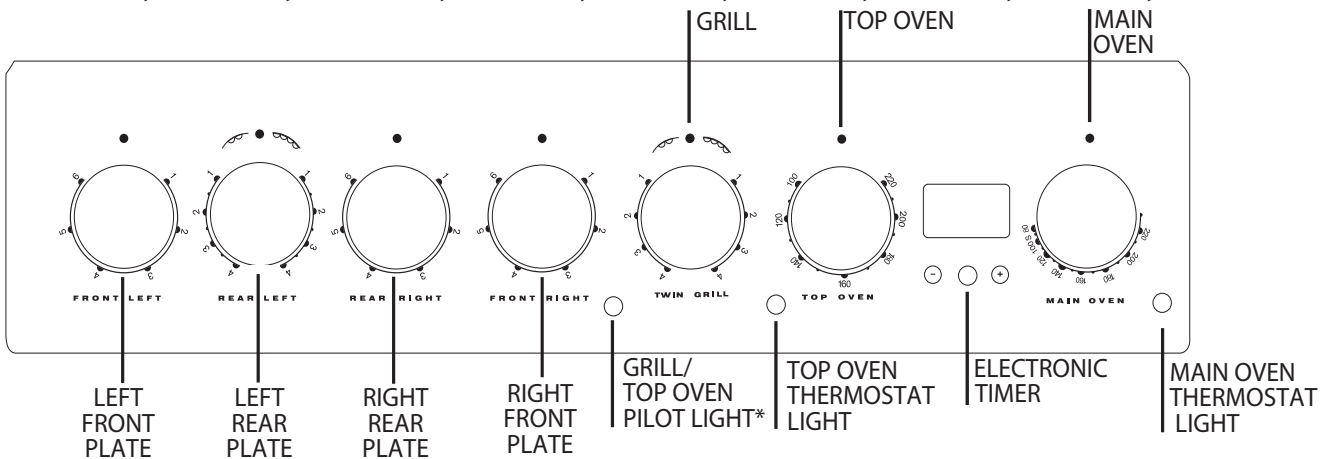

Operating controls when the grill is in use

In common with all cookers having controls sited above the grill compartment, care must be taken when setting the controls, due to the hot air expelled from the grill compartment.

Note: After use, it is advisable to check that all cooker controls have been switched Off.

Cooling fan

A gentle flow of air will be blown below the control panel when the grill control is in use. When the ovens are in use the cooling fan will operate after a short period of time and may run on after all controls are switched off.

Main Oven light

The main oven light will illuminate when the thermostat is operated. The light will remain on during the cook period.

Element and Fan cut off

The oven is fitted with a safety device which disconnects the heating element and oven fan when the door is opened. The heating element and oven fan will not operate until the oven door is closed.

The Grill/ Top Oven Pilot Light

The light remains lit when the top oven or grill is in use.

The top oven thermostat light

The top oven light will come on and wait for the top oven thermostat light to go off, indicating that the oven has reached the right temperature

The main oven thermostat light

The main oven light will come on and wait for the main oven thermostat light to go off, indicating that the oven has reached the right temperature.

*Available only on certain models

Clock/Minute Minder Operation

GB

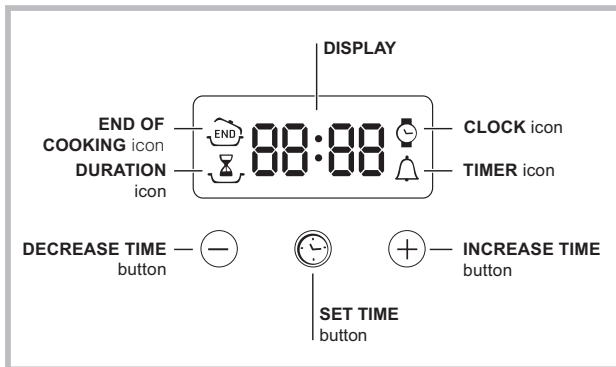



! Only the Main Oven can be controlled by the automatic timer

! NEVER operate the grill when the oven is set to cook automatically because the oven cavity can become warm and this may cause bacterial growth in food.

Setting the clock



! The clock may be set when the oven is switched off or when it is switched on, provided that the end time of a cooking cycle has not been programmed previously. After the appliance has been connected to the mains,

or after a blackout, the  icon and the four numerical digits on the DISPLAY will begin to flash.

1. Press the  button several times until the  icon and the four digits on the display begin to flash.
2. Use the “+” and “-” buttons to adjust the time; if you press and hold either button, the display will scroll through the values more quickly, making it quicker and easier to set the desired value.
3. Wait for 10 seconds or press the  button again to finalise the setting.

Setting the minute minder

! This function does not interrupt cooking and does not affect the oven; it is simply used to activate the buzzer when the set amount of time has elapsed.

1. Press the  button several times until the  icon and the three digits on the display begin to flash.
2. Use the “+” and “-” buttons to set the desired time; if you press and hold either button, the display will scroll through the values more quickly, making it quicker and easier to set the value.
3. Wait for 10 seconds or press the  button again to finalise the setting.



The display will then show the time as it counts down. When this period of time has elapsed the buzzer will be activated.

*Only on certain models

Programming cooking*





! A cooking mode must be selected before programming can take place.

Programming the cooking duration

1. Press the  button several times until the  icon and the three digits on the DISPLAY begin to flash.
2. Use the “+” and “-” buttons to set the desired duration; if you press and hold either button, the display will scroll through the values more quickly, making it quicker and easier to set the value.
3. Wait for 10 seconds or press the  button again to finalise the setting.
4. When the set time has elapsed, the text END appears on the DISPLAY, the oven will stop cooking and a buzzer sounds. Press any button to stop the buzzer and turn all control knobs to the 0 position.
 - For example: it is 9:00 a.m. and a time of 1 hour and 15 minutes is programmed. The programme will stop automatically at 10:15 a.m.

Setting the end time for a cooking mode

! A cooking duration must be set before the cooking end time can be scheduled.

1. Follow steps 1 to 3 to set the duration as detailed above.
2. Next, press the  button until the  icon and the four digits on the DISPLAY begin to flash.
3. Use the “+” and “-” buttons to adjust the cooking end time; if you press and hold either button, the display will scroll through the values more quickly, making it quicker and easier to set the desired value.
4. Wait for 10 seconds or press the  button again to finalise the setting.
5. When the set time has elapsed, the text END appears on the DISPLAY, the oven will stop cooking and a buzzer sounds. Press any button to stop it. Programming has been set when the  and  buttons are illuminated. The DISPLAY shows the cooking end time and the cooking duration alternately.
 - For example: It is 9:00 a.m. and a duration of 1 hour has been programmed. 12:30 is scheduled as the end time. The programme will start automatically at 11:30 a.m.

Cancelling a programme

To cancel a programme:

- press the  button until the icon corresponding to the setting you wish to cancel and the digits on the display are flashing. Press the “-” button until the digits 00:00 appear on the display.
- Press and hold the “+” and “-” buttons; this will cancel all the settings selected previously, including timer settings.

Temperature Conversion Chart



GB

Gas Mark	°F	Main Conventional Oven	Top Conventional Oven	Main Fan Oven
½	250	120	110	100
1	275	140	130	120
2	300	150	140	130
3	325	160	150	140
4	350	180	170	160
5	375	190	180	170
6	400	200	190	180
7	425	220	210	200
8	450	-	220	210
9	475	-	-	220

Using the Ceramic Hob

GB

WARNING: IF THE SURFACE IS CRACKED, SWITCH OFF THE APPLIANCE TO AVOID THE POSSIBILITY OF ELECTRIC SHOCK, FOR HOB SURFACES OF GLASS-CERAMIC OR SIMILAR MATERIAL WHICH PROTECT LIVE PARTS.

	60HEP;62DCW;62DCK;DSC60G;DSC60S;HUE63P 60HEG
Front Right	6 Heat 1500W
Rear Left	6 Heat 1800W
Rear Right	6 Heat 1200W
Front Left	6 Heat 1200W

The Working of the Heating Zones

	HUE61G;HUE61K;HUE61P;HUE61X;HUE63P;HAE6- 0K;HAE60P;HAE60G;HAE60S;HAE60X
Front Right	6 Heat 1800W
Rear Left	Dual Circuit Hilite -Solarglo 1800/750
Rear Right	6 Heat 1200W
Front Left	6 Heat 1200W

Heating only occurs within the marked circular cooking zones. The zones heat up and cool down quicker, providing greater controllability for sensitive foods. Each heating zone is equipped with a thermal limiter which is a safety cut-out which prevents the ceramic glass from overheating. After several minutes at full power without a pan on the heating zone the thermal limiter will switch the heating elements off and on automatically to avoid any damage to the ceramic glass.

The HOT HOB indicator light:

This indicates that the temperature of the corresponding cooking zone is greater than 60°C, even when the heating element has been switched off but is still hot.

Rear Left Dual Circuit hotplate

(models HUE61G;HUE61K;HUE61P;HUE61X;HUE63P;
HAE60K;HAE60P;HAE60G;HAE60S;HAE60X)

This is a dual purpose hotplate with two elements. The settings on the glass control panel will show **1 - 4** when the control knob is turned clockwise to indicate that the whole hotplate is turned on and can be used for a larger pan, **4** is the highest setting. With the control knob turned anti-clockwise the settings on the glass control panel will show **1 - 4** to indicate that only the inner part of the hotplate is switched on.

This is an energy saving feature and is useful for cooking with smaller pans or for simmering. The control will be **OFF** when the control knob is turned to the **0** position.

Choice of saucepan's

It is essential that the saucepan's you use on the ceramic hob are suitable.

ALWAYS USE:

- Good quality pans with smooth, flat, heavy bases.
- saucepan's manufactured from aluminium (enamelled or machined) or stainless steel.
- Correct size saucepan's. The base of the pan must cover the heating zone completely.
- saucepan's with lids which are well fitting to reduce cooking time and energy use.

NEVER USE:



- Pans with thin, distorted or uneven bases as these will extend cooking times, waste electricity and cause damaging, local hotspots on the glass surface.
- Pans with ridged or recessed bases.
- Pans with damaged or rough bases which could

Care of the Ceramic Hob

- scratch the glass surface.
- Glass or glass ceramic utensils.

Do Not

In order to keep your ceramic hob in good condition, follow these simple guidelines:

- Do not** stare at halogen heating units.
- Do not** cook directly on the hob surface without a cooking utensil, as this will result in damage to the surface of the hob.
- Do not** use the hob as a worktop surface as damage may occur to the smooth surface of the hob.
- Do not** drag or slide utensils on the hob surface, as this will cause scratches in the surface of the hob.
- Do not** allow a cooking utensil to come into contact with the hob surround. 
- Do not** place anything between the base of the utensil and the ceramic hob, e.g. do not use asbestos mats, aluminium or wok stand.
- Do not** leave any utensils, food or combustible items on the hob when it is not in use.
- Do not** place aluminium or plastic foil, or plastic containers on the hob.
- Do not** leave the hotplates or cooking areas switched On unless they are being used.
- Do not** leave heating zones uncovered when they are switched On. We recommend not to place large preserving pans or fish kettles across two heating areas. 
- Do not** leave utensils partly covering the heated areas. Always ensure that they are placed centrally over the heated areas and have the same diameter as the heating area used.

Do

- Always** ensure that the bottom of the pan is both clean and dry. Dirt or moisture between the pan and the hob can cause pitting of the surface of the glass.

We do not recommend the use of utensils with a base diameter greater than 25cm (10ins). Pressure cookers or other large pans should be used on the front cooking areas.

- Always** ensure that saucepan handles are positioned safely.

- Always** take extra care when cooking foods with a high sugar content eg. jam, as spillage will

- Always** cause damage to the surface of the glass. clean spills immediately (see Care and Cleaning).

IMPORTANT - As with any cooking appliance there could be some fire risk attached to the heating of oil, particularly for deep fat frying, cooking utensils containing oil **must not be left unattended** (e.g. to answer the telephone) on or in close proximity to the patterned cooking areas.

1. Use a deep pan, large enough to completely cover the appropriate heating area.
2. Never fill the pan more than one-third full with fat or oil.
3. Never leave oil or fat unattended during the heating or cooking period.
4. Do not try to fry too much food at a time, especially frozen food. This only lowers the temperature of the oil or fat too much, resulting in greasy food.
5. Always dry food thoroughly before frying, and lower it slowly into the hot oil or fat. Frozen foods, in particular, will cause frothing and spitting, if added too quickly.
6. Never heat fat, or fry, with a lid on the pan.
7. Keep the outside of the pan clean and free from streaks of oil or fat.
8. Never allow excessive splashing of oil onto the hob.

Safety requirements for deep fat frying

In the unfortunate event of a chip pan fire:

1. Switch **Off** the electricity supply. **NEVER** attempt to move the pan - burns and injuries are caused almost invariably by picking up the burning pan and rushing outside with it.
2. Smother flames with a fire blanket or damp cloth. **NEVER** use a fire extinguisher to put out a pan fire, as the force of the extinguisher is likely to tip the pan over. **NEVER** use water to extinguish oil or fat fires. When smothering the flames **DO ENSURE** that your **FACE** and **ARMS** are **WELL PROTECTED** from the flames to save you from becoming hurt.
3. After the fire has been extinguished **LEAVE THE PAN TO COOL FOR AT LEAST 60 MINUTES BEFORE MOVING IT.**
4. If you fail to put the fire out, call the fire brigade immediately.

Grill

GB

Setting the Grill

CAUTION: Accessible parts may become hot during use. Young children should be kept away.

GRILLING SHOULD NEVER BE UNDERTAKEN WITH THE GRILL/TOP OVEN DOOR CLOSED.

The grill control is designed to provide variable heat control of either the twin grill elements on together or the single left hand grill element only, depending upon which direction the control knob is rotated. With the control rotated clockwise **1** through to **4** the twin elements will come on together. With the control turned anti-clockwise **1** through to **4** and the single left hand element will come on only. The control is **Off** at **O**.

Note: The grill will not operate unless the top oven control is in the OFF position.

Food which requires browning only should be placed under the hot grill, directly on the shelf in the first or second runner from the bottom of the oven, according to the depth of the dish.

Open the Grill door to the grilling position. i.e. fully. With the grill door in the grilling position, heating the grill is achieved by turning the control clockwise to the desired 'grill setting' on the control panel.

Never: line the grill pan with aluminium foil.

Note: Preheat the grill at setting **4** for approximately **5** minutes.

The grill pan is placed on the shelf or grill pan support and should be correctly positioned under the grill element.

Leave the control at **4** for toast, sealing and fast cooking of foods.

For thicker foods requiring longer cooking, turn the switch to a lower setting after the initial sealing on both sides at **4**.

The thicker the food the lower the control should be set.

GUIDE TO GRILLING

Pre-heat the grill for 5 minutes on maximum control setting before grilling

The settings in the above guide have been developed to cook food successfully without excessive fat spitting and splashing.

Grill Pan Handle

The grill pan handle is detachable from the pan to facilitate cleaning and storage. Fix the pan handle securely before use:

1. Fit the handle to the grill pan so that the external 'hooks' embrace the edge of the pan (fig. 1)
2. Make sure that the middle part of the handle fits exactly the protruding support of the pan (fig .2) and holds the pan from the bottom.

The food must be placed on the rack in the grill pan. Position the grill pan on top of the oven rack. The best results are achieved by placing the oven rack on the uppermost shelves. Pouring a little water into the grill pan will make the collection of grease particles more efficient and prevent the formation of smoke.

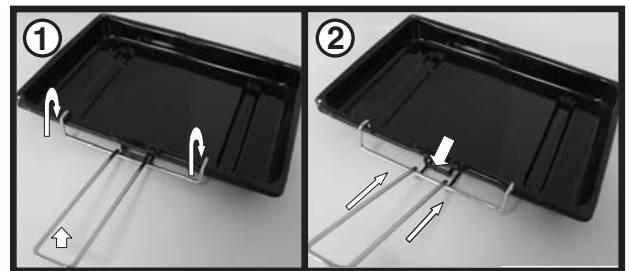

GRILL CHART

Food	Grill Setting	Approximate Cooking time
Toasting of Bread products	4	3 - 10 mins.
Small cuts of meat, sausages, bacon, etc.	4 for 4 mins. reduce to lower setting.	10 - 20 mins.
Chops etc. Gammon steaks Chicken pieces	4 for 6-8 mins. reduce to lower setting.	20 - 30 mins.
Fish: fingers Whole Fillets	4	10 - 20 mins. Whole fish and fillets placed in the base of the grill pan.
Fish in bread crumbs	3	15 - 20 mins.
Pre - Cooked potato products	3	15 - 20 mins.
Pizzas	3	12 - 15 mins. in the base of the grill pan.
Browning of food	4	8 - 10 mins. Dish placed directly on the shelf.

Warning: Accessible parts may become hot during use. Young children should be kept away.

Your cooker is not fitted with a conventional type of grill. The **solarplus** grill is designed to reduce your grilling times. It is quicker because it takes less time to warm up from cold. Conventional grills require 5 minutes pre-heat before food is placed beneath them, but for normal grilling the **solarplus** grill can be used from cold without any pre-heat. However, when toasting, optimum performance is achieved by pre-heating the grill for about 1 minute.

Notes

You will notice that the grill elements are protected by a wire mesh.

This stops you from touching live parts.

DO NOT under any circumstances insert objects into the grill mesh as this could damage or break the element tubes OR if the grill is on cause an electric shock.

During use the mesh may become soiled. Do not attempt to clean it while the grill is still on. Turn the cooker off at the control unit and wait until it has cooled down before cleaning.

Care must be taken to ensure the grill mesh is not distorted - DO NOT store the grill pan handle on the grill pan grid when the grill pan runners are on the top runner position.

There are two halves to the grill, one on the left and one on the right. You can choose to have both sides on or just the left side on.

Turning the control knob clockwise, will switch both sides on. Turning it anti-clockwise, will only switch the left side on.

The numbers which are displayed indicate the heat setting:

MAXIMUM is the hottest and **MINIMUM** the coolest.

GRILLING SHOULD NOT BE UNDERTAKEN WITH THE TOP OVEN/GRILL DOOR CLOSED - This will cause overheating.

The grill will not operate unless the top oven control is in the Off position, 'O'.

To operate the grill proceed as follows:

1. Open the grill/top oven door fully.
2. Position the rod shelf as recommended, in the chart (next page), for the food being cooked.
3. Place the grill pan on the rod shelf, ensuring it is positioned centrally under the element.
4. Never line the grill pan with aluminium foil as this may cause overheating of fat in the grill pan.

Food	Pre-heat	Shelf Position from base of oven	Setting	Approx. Cooking Time	Comments
Toasting of Bread Products	1 min.	3 or 2	Maximum	3-5 minutes. Grill pan and grid.	NOTE: Position 1 is bottom runner from the base of the oven.
Small cuts of meat – Sausages, Bacon	None	3 or 2	Maximum for 4 minutes, then reduce to 3	10-15 minutes. Grill pan and grid.	
Chops, etc. Gammon Steaks, Chicken pieces	None	2	Maximum or 6-8 minutes. reduce to 3-2,5	25-30 minutes. Grill pan and grid.	
Fish	Whole:	2	Maximum	6-8 minutes.	
	Filletts:	3 or 2	Maximum	In base of grill pan.	
Fish in breadcrumbs	None	3 or 2	3	10-15 minutes. Grill pan and grid.	
Pre-cooked Potato Products	None	3 or 2	3	10-12 minutes.	
Pizzas	None	3 or 2	3	10-15 minutes. Grill pan and grid.	
Browning of Food	1 min.	1 or 2	Maximum	5-7 minutes. Dish placed directly on shelf.	

* Available only in the models: 60HEP;60HEG and HUE63P

Top Oven Cookery Notes

GB

The top oven should be used to cook small quantities of food. The oven is designed so that the grill element operates at a reduced heat output, this is combined with a heating element situated underneath the floor of the oven.

To ensure even cooking of the food it is important that cooking utensils are positioned correctly on the oven shelf so that the element is directly above.

There are two cooking positions, the shelf placed on runner 1 or 2 (from the base), do not use shelves upside down.

Food/utensils must not be placed directly on the oven floor.

There should always be at least 25mm (1in) between the top of the food and the grill element.

Warning: Items stored in top oven will get hot when main oven is in use.

Operation

To heat the oven, turn the control knob clockwise. The top oven pilot light will come on and remain on until the oven reaches the required temperature. The pilot light will automatically go on and off during cooking as the thermostat maintains the correct temperature.

Cooking meat/poultry

Small joints of meat up to 1.5kg (3 lbs), or poultry, up to 3.6kg (8 lbs) (60cm cookers) in weight can be roasted in a small meat pan in the top oven. Larger joints of meat/poultry weighing more than 3.6kg (8 lbs) (60cm cookers) should be roasted in the main oven.

Do not use the grill pan as a meat pan in the top oven as air circulation will be seriously restricted.

Top oven as a warming compartment for plates

Place the plates/dishes on the shelf, positioned on runner 1, turn top oven control to 100°C for 10-15 minutes. Never use grill control.

Main Oven Cookery Notes

To heat the oven turn the knob clockwise, selecting the required temperature between 80°C (176°F) and 230°C (450°F) as recommended in the temperature chart. The pilot light will immediately come on and remain on until the oven reaches the required temperature. This light will then automatically go off and on during cooking as the oven thermostat maintains the correct temperature.

It should be noted that at the end of the cooking period there may be a momentary puff of steam when the oven door is opened. This will disperse in a few seconds and is a perfectly normal characteristic of an oven with a good door seal.

Since a circulaire fan oven heats up more quickly, and generally cooks food at a lower temperature than a conventional oven, pre-heating is often unnecessary. However, foods such as bread, scones, Yorkshire pudding, do benefit from being placed in a pre-heated oven.

The 'oven temperature charts' are a guide only, giving approximate cooking temperatures and times. To suit personal taste and requirements, it may be necessary to increase or decrease temperatures by 10°C.

Unless otherwise indicated in the charts food should be placed in a cold oven, i.e. without pre-heating. If food is placed in an already hot oven, the suggested cooking time should be reduced, depending on the type and quantity of food being cooked.

Oven positions

Since the distribution of heat in the circulaire fan oven is very even, most foods will cook satisfactorily

on any shelf position, but the shelves should be evenly spaced.

The top oven rod shelf can be used in the main oven when cooking large quantities of food. Additional shelves can be purchased through your oven supplier or our Parts Department (see Key Contacts, back page).

Food or utensils should Never be placed directly on the floor of the oven for cooking.

Never use more than 3 shelves in the oven as air circulation will be seriously restricted. To ensure oven circulation do not use meat pans larger than 390 x 300mm (15"x12") and baking trays no larger than 330 x 255mm (13"x 10"), these should be positioned centrally on the oven shelf.

Food should not be placed directly on the floor of the oven. To avoid unnecessary cleaning, rod shelves which are not in use, should be removed from the oven.

Temperature and time

When all three shelves are used to cook large quantities of food for home freezing or parties, it may be necessary to increase the cooking times given in the temperature charts by a few minutes, to allow for the loss of heat due to extra time taken to load the oven, and the larger mass of food. Baking trays should have an equal gap at either side of the oven.

Frozen meat and poultry

Joints of meat and whole birds should be defrosted slowly, preferably in a domestic refrigerator (allowing 5-6 hours per 450g (1 lb), or at room temperature (allowing 2-3 hours per 450g (1 lb)).

! When inserting the shelf make sure the backstop is at the rear of the cavity (see image)

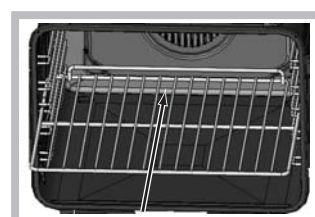

Oven Cooking Charts

- Baking

GB

	Top Oven Cooking			
Baking	Pre-heat	Temperature °C	Time in mins.	Position in Oven
Scones	Yes	210/220	10-15	Runner 2 from bottom of oven
Small Cakes	Yes	180/190	20-25	Runner 2 from bottom of oven
Victoria Sandwich	Yes	170/180	20-30	Runner 2 from bottom of oven
Sponge Sandwich	Yes	180/190	20-25	Runner 2 from bottom of oven
Swiss Roll	Yes	200/210	10-15	Runner 2 from bottom of oven
Semi-rich Fruit cakes	Yes	150/160	60-75 7 inch	Runner 2 from bottom of oven
Rich Fruit Cakes	Yes	140/150	Depending on size	Runner 1 or 2 from bottom of oven
Shortcrust Pastry	Yes	190/200	Depending on size	Runner 2 from bottom of oven
Puff Pastry	Yes	200/210	Depending on size	Runner 2 from bottom of oven
Yorkshire Pudding	Yes	190/200	30-40	Runner 2 from bottom of oven
Individual Yorkshire Pudding	Yes	200/210	20-30	Runner 2 from bottom of oven
Milk Pudding	Yes	140/150	90-120	Runner 2 from bottom of oven
Baked Custard	Yes	150/160	40-50	Runner 2 from bottom of oven
Bread	Yes	200/210	30-45	Runner 1 from bottom of oven
Meringues	Yes	100	150-180	Runner 2 from bottom of oven

	Fan Oven Cooking			
Baking	Pre-heat	Temperature °C	Time in mins.	Position in Oven
Scones	Yes	210/220	8-10	Runner 2 from bottom of oven
Small Cakes		170/180	15-20	Runner 2 from bottom of oven
Victoria Sandwich		160/170	20-25	Runner 2 from bottom of oven
Sponge Sandwich	Yes	170/190	15-20	Runner 2 from bottom of oven
Swiss Roll	Yes	180/190	10-15	Runner 2 from bottom of oven
Semi-rich Fruit cakes		140/150	60-75	Runner 2 from bottom of oven
Rich Fruit Cakes		130/140	Depending on size	Runner 1 or 2 from bottom of oven
Shortcrust Pastry		190/200	45-50	Runner 2 from bottom of oven
Puff Pastry		190/200	Depending on use	Runner 2 from bottom of oven
Yorkshire Pudding	Yes	180/190	40-45	Runner 2 from bottom of oven
Individual Yorkshire Pudding	Yes	190/200	20-25	Runner 2 from bottom of oven
Milk Pudding		130/140	105-135	Runner 2 from bottom of oven
Baked Custard		140/150	40-50	Runner 2 from bottom of oven
Bread	Yes	200/210	40-50	Runner 1 from bottom of oven
Meringues		80-90	180-240	Runner 2 from bottom of oven

Note: If soft margarine is used for cake making, temperatures recommended by the manufacturers should be followed. Temperatures recommended in this chart refer to cakes made with block margarines or butter only.

Oven Cooking Charts

- Meat



GB

Top Oven Cooking				
Meat	Pre-heat	Temperature °C	Time (approx.)	Position in Oven
Beef/ Lamb (slow roasting)	Yes	170/180	35 mins per 450g (1lb) + 35 mins over.	Runner 1 from bottom of oven.
Beef/ Lamb (foil covered)	Yes	190/200	35-40 mins per 450g (1lb)	
Pork (slow roasting)	Yes	170/180	40 mins per 450g (1lb) + 40 mins over	
Pork (foil covered)	Yes	190/200	40 mins per 450g (1lb)	
Veal (slow roasting)	Yes	170/180	40-45 mins per 450g (1lb) + 40 mins over	
Veal (foil covered)	Yes	190/200	40-45 mins per 450g (1lb)	
Poultry/Game (slow roasting)	Yes	170/180	25-30 mins per 450g (1lb) + 25 mins over	
Poultry/Game (foil covered)	Yes	190/200	25-30 mins per 450g (1lb)	
Casserole Cooking	Yes	150	2-2½ hrs	

If using aluminium foil, never:
1.Allow foil to touch sides of oven. **2.**Cover oven interior with foil. **3.**Cover shelves with foil.

Fan Oven				
Meat	Pre-heat	Temperature °C	Time (approx.)	Position in Oven
Beef	No	160/180	20-25 mins per 450g (1lb) + 20 mins extra.	Runner 1 from bottom of oven.
Lamb	No	160/180	20-30 mins per 450g (1lb) +25 mins extra.	
Pork	No	160/180	25-30 mins per 450g (1lb) +25 mins extra.	
Veal	No	160/170	25-30 mins per 450g (1lb) +25 mins extra.	
Chicken/Turkey up to 4kg (8lb)	No	160/180	18-20 mins per 450g (1lb) + 20 mins extra.	
Turkey 4 to 5.5kg (8 to 12lb)	No		13-15 mins per 450g (1lb) at 150/160°C	
Turkey 4 to 5.5kg (8 to 12lb)			allow 12 mins per 450g (1lb) at 150°C	
Casserole Cooking	No	140-150	1½ - 2 hrs	

If using aluminium foil, never:
1.Allow foil to touch sides of oven. **2.**Cover oven interior with foil. **3.**Cover shelves with foil.

The most accurate method of testing the readiness of joints of meat or whole poultry is to insert a meat thermometer into the thickest part of a joint, or the thickest part of poultry thighs, during the cooking period. The meat thermometer will indicate when the required internal temp has been reached.

Beef - Rare: 60°C **Lamb:** 80°C **Poultry:** 90°C
 Medium: 70°C **Pork:** 90°C
 Well Done: 75°C **Veal:** 75°C

Using The Main Oven for other Functions

GB

'S' SLOW setting

"Slow" cook is identified as 'S' on the oven temperature scale. This is used for slow cooking, keeping food warm and warming plates for short periods. Extra care should be taken when warming bone china, as it may be damaged in a hot oven.

DO NOT place food or plates directly on the oven floor as this could damage both the oven lining and the plates which are being warmed.

Advantages of "SLOW" cooking are:

The oven stays cleaner because there is less splashing.
Timing of food is not as critical, so there is less fear of overcooking.
Inexpensive joints of meat are tenderised.
Fully loading the oven can be economical.
Cooking times can be extended in some cases by up to 2 hours.

Operation:

1. Place the prepared food in the main oven and ensure the door is fully closed.
2. Select 'S' (Slow Cooking Temperature) by turning Main Oven Temperature Control clockwise ensuring the oven door is fully closed.

Storage and re-heating of food:

1. If food is to be frozen or not used immediately, place it in a clean container and cool as soon as possible.
2. Always thaw frozen food completely in the refrigerator before re-heating.
3. Always reheat food thoroughly and ensure it is piping hot before serving.
4. Only re-heat food **once**.

Points to consider when preparing food for "SLOW" cooking:

1. Make sure that the dishes to be used will fit into the oven ensuring enough room for air to circulate.
2. All dishes cooked on the slow setting will require a minimum of 6 hours, however, if they are cooked for 1-2 hours longer then deterioration in their appearance may be noticed.
3. Never cook joints of meat over 2.7kg (6 lb) or poultry over 2.0kg (4 lb 8oz). We do not recommend that joints of meat or poultry are stuffed before cooking on the slow setting.
4. To seal in the meat juices, always cook meat or poultry at 170°C for 30 minutes before wrapping in foil and placing on a rack over a meat tin (to allow good air circulation) before turning the control to the slow setting and cooking immediately.
5. Always ensure that joints of pork and poultry are thoroughly cooked by checking with a meat thermometer before serving.
6. Always thaw frozen foods completely before cooking. We do not recommend placing frozen food in the oven to cook.
7. Always bring soups, liquids and casseroles to the boil before placing in the oven.
8. Ensure that casserole dishes have a good seal (not airtight) and cover food first with foil and then the lid to prevent loss of moisture.
9. Ensure that fruit and vegetables are cut into even sized small pieces to cook properly.
10. Always adjust seasoning before serving.
11. If using dried red kidney beans it is important that the beans are soaked and then boiled for a minimum of 10 minutes before using in any dish to destroy any toxins.
12. Egg and fish dishes need only 1-5 hours cooking and should be included in day cooking sessions, where they can be checked from time to time.

TURN OFF THE MAIN SWITCH AND ENSURE THE COOKER IS COLD BEFORE CLEANING. BEFORE SWITCHING ON AGAIN, ENSURE THAT ALL CONTROLS ARE IN THE OFF POSITION.

NEVER USE BIOLOGICAL WASHING POWDER, HARSH ABRASIVES, SCOURING PADS, AEROSOL CLEANERS OR OVEN CHEMICAL CLEANERS OF ANY KIND, UNLESS SPECIFIED BELOW.



! Never use steam cleaners or pressure cleaners on the appliance.

! Clean the glass part of the oven door using a sponge and a non-abrasive cleaning product, then dry thoroughly with a soft cloth. Do not use rough abrasive material or sharp metal scrapers as these could scratch the surface and cause the glass to crack.

! The accessories can be washed like everyday crockery (even in your dishwasher).

Cleaning materials to avoid:

1. Plastic or nylon pads
2. Household abrasive powders and scourers. These may scratch the surface.
3. Oven chemical cleaners, aerosols and oven pads. Caustic cleaners such as these will etch the surface and attack the metal frame.
4. Bath and sink cleaners may mark the surface.

ALWAYS SWITCH OFF AT THE MAINS SWITCH BEFORE CLEANING.

Ceramic hotplates:

Clean your Ceramic hob top regularly and avoid repeated burning of encrusted contamination.

Your choice of cleaner will depend on the degree of soiling involved (see below).

- **minor soiling**, where the contamination has not burnt hard, can be wiped off with a clean wet cloth
- **major soiling** and strongly-adhering burnt encrustation can be quickly and easily removed with a razor-blade scraper
- hard water stains, grease spots and discoloration having a metallic sheen can be removed with 'Easy Do Cleaner Powder'

- always condition hob after cleaning by using 'Easy Do Conditioner' or 'Hob Brite'. Apply a small amount of conditioner with a clean damp cloth or paper towel. Rub vigorously. Remove excess with a clean damp cloth or paper towel. Polish with a clean cloth or paper towel before the conditioner dries.

Detergent residues must always be completely removed with a clean wet cloth, (even if the instructions for use suggest otherwise), as they can have an etching effect when reheated. Then wipe dry.

To maintain hob in good condition, we would recommend regular use of the 'Easy Do Powder Cleanser'.

Sprinkle Powder Cleanser on a clean damp cloth or paper towel and rub vigorously for 3 to 4 minutes. Remove all residue with a clean damp cloth or paper towel. Then use conditioner to protect the hob.

For more stubborn marks, mix a small amount of the powder cleanser with 'Jif Lemon Juice' (from a bottle) and carefully spread over the affected area. Cover with a damp paper towel and leave for a minimum of 15 minutes. Rub vigorously. Remove excess with a clean damp cloth or paper towel before the conditioner dries. Polish with a clean cloth or paper towel.

Easy Do products are available from many electrical retailers and our Parts Department. Homecare 'Hob Brite' is available from leading Supermarkets.

'STAY CLEAN' Oven liners

Refer to the instructions below for cleaning the 'Stay clean' panels.

How "STAY CLEAN" works:

The surfaces of the 'Stay clean' oven liners are treated on the mottled face with a special vitreous enamel which absorbs cooking soils. At temperatures of 220°C (425°F) or above, the special surface enables these soils to be slowly destroyed. The higher the temperature the more effective it is. In most cases normal cooking operations at this temperature will permit this cleaning operation to proceed during cooking. However if higher cooking temperatures are not used regularly it may be necessary in order to prevent heavy soiling, to run the oven without a meat pan at maximum setting for a couple of hours.

Care and Cleaning

GB

Main Oven Liners - side and rear panels.
Top Oven Liners - sides

It should not normally be necessary to clean the 'Stay clean' panels in water. If the user feels it is desirable to do so, wash them in warm soapy water, followed by rinsing in clean water. **Do not use enzyme/biological washing powder, harsh abrasives or oven chemical cleaners of any kind.**

Decorative trims (all models):

It is advisable to clean the decorative trims regularly to prevent any build up of soiling which may detract from the appearance of the cooker.

The recommended method of cleaning is to wipe over the trims with a soft cloth wrung out in hot water or mild non-abrasive cleaner. (If in doubt try the cleaner on a small area of trim which is not noticeable in normal use).

Then, after wiping with a cloth wrung out in clear water, dry with a soft clean cloth.

Never use scouring pads or abrasive cleaners/powders which may scratch the surface.

Take care during cleaning not to damage or distort the door seals. Do not lift the door seal from the oven chassis, if necessary remove the seal by carefully unhooking the corner clips.

Take care that the rating label edges are not lifted during cleaning, and furthermore that the lettering is not blurred or removed.

Control Panel:

Wipe with a damp cloth and polish with a dry cloth.

Stainless trims:

Regularly wipe with a clean, damp cloth and polish with a clean dry cloth.

Grill:

Remove the wire grid food support, it is best to wash these items immediately after use to prevent stains from being burnt on when used again. Wipe out the Grill compartment, use a fine steel wool soap pad to remove stubborn stains from the floor of the compartment.

Main oven:

1. Glass Door - open the oven door fully. The glass panel may now be cleaned. Stubborn stains can be removed by using a fine steel wool soap pad. Do not use scouring pads, or abrasive powder, which will scratch the glass. Ensure that the glass panel is not subjected to any sharp mechanical blows. For

slight soiling the inner glass panel may be cleaned, while still warm. For removing stubborn stains see next page.

2. Remove the rod shelves. Use a fine steel wool soap pad to remove stubborn stains from the rod shelves and the floor of the oven. Refer to the instructions on previous page for cleaning the 'Stay clean' panels.

Doors

Wipe over the outer door glass panels with a cloth wrung out in warm soapy water, then after wiping with a cloth wrung out in clear water, dry with a soft clean cloth. **Ensure that glass doors are not subjected to any sharp mechanical blows.**

Glass Inner Door Panel

Open the door fully and **unscrew the two screws securing the glass panel**, taking care not to allow the glass to fall. The glass panel may now be washed at the sink. Stubborn stains can be removed by using a fine steel wool soap pad. **Ensure the glass panel is not subjected to any sharp mechanical blows.** Take particular care not to damage the inner surface which is coated with a heat reflective layer. After cleaning, rinse and dry with a soft cloth. For slight soiling the inner glass panel may be cleaned, while still warm, without removing it from the door.

Warning: Oven must not be operated with inner door glass removed.

Do not use aerosol cleaners on this oven as they could adversely affect the fan motor unit, and cannot be wiped off the fan blade.

Replacement oven lamp:

WARNING: Ensure that the appliance is switched off before replacing the lamp to avoid the possibility of electric shock.

Open the oven door and remove the rod shelves. Using a suitable cloth to protect the fingers grip the light glass dome, unscrew anti-clockwise and lift. Reach into the aperture and unscrew the lamp anti-clockwise. Fit replacement lamp (25W 300°C rated SES), refit dome.

Do not use the oven lamp as/for ambient lighting

Wall-mounted splashpanel:

A wall-mounted splashpanel is available as an optional extra from the Spare Parts Department. See back cover for details.

Care must be taken that rating label edges are not lifted during cleaning and furthermore that the lettering is not blurred or removed.

For details of your nearest Service Centre please see the separate service leaflet. If you have any queries regarding service or spares, our Spares and Service Division will be pleased to advise.

Glass inner Door with three Panels (HUE61; HUE63P)

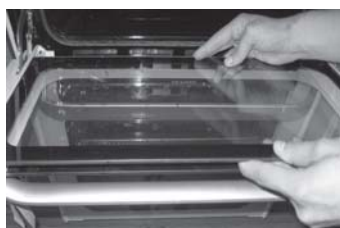

Open the door fully and carefully slide the inner glass towards you, taking care not to allow the glass to fall.

The glass panel may now be washed at the sink. Stubborn stains can be removed by using a fine steel wool soap pad. **Ensure the glass panel is not subjected to any sharp mechanical blows.** Take particular care not to damage the inner surface which is coated with a heat reflective layer. After cleaning, rinse and dry with a soft cloth. For slight soiling the inner glass panel may be cleaned, while still warm, without removing it from the door. Warning: Oven must not be operated with inner door glass removed.

SIDE OPENING DOORS

Cleaning the door glass is the same as the drop down doors, except take care to support the weight of the inner glass when removing and refitting.

Take care during cleaning not to damage or distort the door seals. Do not lift the door seal from the oven chassis, if necessary remove the seal by carefully unhooking the corner clips.

Take care that the rating label edges are not lifted during cleaning, and furthermore that the lettering is not blurred or removed.

When refitting the glass make sure it is fitted correctly i.e. reflective face is fitted the right way round.

Cleaning the glass doors

SIDE OPENING DOORS

Cleaning the door glass is the same as the drop down doors.



Open the lower door and lift out the inner door glass



Remove the two rubber anti-rattle bungs



Remove the centre glass taking care to support the weight of the glass when removing and fitting

The glass panels may now be washed at the sink. Stubborn stains can be removed by using a fine steel wool soap pad.

Replace in the reverse order.

Ensure anti-rattle bungs are fitted before fitting inner door glass.

BE CAREFUL NOT TO DAMAGE THE GLASS PANELS BY PUSHING THEM TOO HARD.

When fitting the glass make sure it is fitted correctly i.e. reflective face is fitted the right way round.

Ensure the glass panel is not subjected to any sharp mechanical blows. Take particular care not to damage the inner surface which is coated with a heat reflective layer. After cleaning, rinse and dry with a soft cloth. For slight soiling the inner glass panel may be cleaned, while still warm, without removing it from the door

Warning: Oven must not be operated with inner door glass removed.

Anti- rattle bung

The door glass is equipped with anti-rattle bungs which prevents rattling of the glass when opening and shutting the oven main door. These can be

removed for washing.

WARNING : Be careful not to lose the bungs when cleaning

Cooking Results Not Satisfactory?



GB

Problem	Check
Grilling Uneven cooking front to back	Ensure that the grill pan is positioned centrally below the grill element.
Fat splattering	Ensure that the grill is not set to too high a setting.
Baking (General) Uneven rising of cakes	Ensure that the oven shelves are level by using a spirit level on the rod shelf and adjusting the wheels/feet. The oven should be checked both left to right and front to back.
Sinking of cakes	Sinking of cakes The following may cause cakes to sink: 1. Preheating of fan ovens. 2. Cooking at too high a temperature. 3. Using normal creaming method with soft margarine. (use the all-in-one method). 4. If using soft margarine use the all-in-one method
Over/Under cooking Fast/Slow cooking	Refer to the cooking times and temperatures given in the oven temperature charts, however, it may be necessary to increase or decrease temperatures by 10°C to suit personal taste. Do not use utensils greater than 56mm (2¼ins) in height.
Uneven cooking of cakes	1. Too large baking sheet used. (See 'Cookery Notes', for correct sizes). 2. Over loading of oven and always ensure even air gaps around baking tins. 3. Placed into pre-heated oven. (See oven temperature charts)
Top Oven Baking: Uneven cooking front to back	Ensure the cooking utensil is positioned centrally under the grill element.
Uneven rising of cakes	Ensure that the shelf is level (see above) and that the food is positioned centrally in the oven.
Overcooking	Remember to reduce cooking temperatures by 10°C from standard recipes when using the top oven.
Food is taking too long to cook	Ensure that the cooking utensil used in the top oven is not larger than 300x225mm (12ins x 9ins). Only cook one item at a time to avoid overloading the oven.

Something Wrong with your Cooker?

GB

Before contacting your nearest Service Centre/Installer, check the problem guide below; there may be nothing wrong with your cooker.

Problem	Check
Slight odour or small amount of smoke when grill / oven used for first time	This is normal and should cease after a short period.
Nothing works	If you find that the timer display is blank, then it is likely that there is no electricity supply to your oven. Check: (i) That the wall cooker socket is switched on (ii) Other appliances, to see if you have had a power cut (iii) The main circuit breaker for the property
Top Oven and Grill do not work... Main oven works	Operating the cooker under the following conditions may cause a safety device to operate: (a) Grilling with the door closed - Always grill with the door fully open (b) Grilling for an excessively long period at maximum setting - see Grilling guide. Switch off appliance and allow to cool for approx 30 mins. Switch the cooker back on and check that the Grill / Top oven is now operating.
Grill does not work	Ensure that the grill control is turned on.
Grill keeps turning on and off	When the Grill control is operating at less than its maximum setting, the Grill will cycle on and off, this is normal and <u>not</u> a fault.
Timer is showing '0.00'	The power supply to your oven has possibly been interrupted, but has now come back on again. Reset the timer to the correct time of day using the instructions given in the timer section of the book.
Timer buzzer operates continually	To cancel the audible tone: - press the manual button once. - press the minute minder button once.
Oven temperatures too high or low	Check temperature and shelf positions are as recommended in the Oven Temperature Charts. It may be necessary to increase or decrease the recommended temperature slightly to suit your taste.
Oven does not cook evenly	Check: (a) Temperature and shelf positions are as recommended in the Oven Temperature Charts. (b) Oven utensils being used allow sufficient air flow around them.
Main oven door rattles when opening or shutting	Check that anti-rattle bungs have been re-fitted after cleaning, and that they been fitted correctly

Something Wrong with your Cooker?



GB

Problem	Check
Oven lamp does not work	The oven lamp is not covered by the guarantee. The part is easily changed (see the section on oven lamp replacement). A new lamp may be obtained from our Parts department see Key Contacts, back page.
Draught from beneath control panel	A gentle flow of air will be blown from beneath the control panel when the appliance is used. If the appliance is still warm, this cooling fan may run on, or restart itself when all controls have been turned off. The fan will stop once the appliance has been cooled. This is normal and not a fault.
Condensation on the wall at the rear of the cooker.	Steam and / or condensation may appear from the vent at the rear of the appliance when using an oven particularly for foods with a high water content e.g. frozen chips, roast chicken etc. This is normal, and any excess should be wiped off.
Steam / Condensation in the oven after use.	Steam is a by - product of cooking any food with a high water contact. To help minimise always: a) Try to avoid leaving food in the oven to cool after being cooked. b) Use a covered container, wherever possible.

If you have been through the above list and there is still a problem; Contact Service, see Key Contacts (back cover).

Disposal of your product

To minimise the risk of injury to children please dispose of your product carefully and safely. Remove all doors and lids. Remove the mains cable (where fitted) by cutting off flush with the appliance and always ensure that no plug is left in a condition where it could be connected to the electricity supply.

To help the environment, Local Authority instructions should be followed for the disposal of your product.



Disposal of old electrical appliances

The European Directive 2002/96/EC on Waste Electrical and Electronic Equipment (WEEE), requires that old household electrical appliances must not be disposed of in the normal unsorted municipal waste stream. Old appliances must be collected separately in order to optimise the recovery and recycling of the materials they contain and reduce the impact on human health and the environment.

The crossed out "wheeled bin" symbol on the product reminds you of your obligation, that when you dispose of the appliance it must be separately collected.

Consumers should contact their local authority or retailer for information concerning the correct disposal of their old appliance.

Guarantee

12 months Parts and Labour Guarantee

Your appliance has the benefit of our manufacturer's guarantee, which covers the cost of breakdown repairs for twelve months from the date of purchase.

This gives you the reassurance that if, within that time, your appliance is proven to be defective because of either workmanship or materials, we will, at our discretion, either repair or replace the appliance at no cost to you.

The guarantee is subject to the following conditions:

- The appliance has been installed and operated correctly and in accordance with our operating and maintenance instructions.
- The appliance is only used on the electricity or gas supply printed on the rating plate.
- The appliance has been used for normal domestic purposes only.
- The appliance has not been altered, serviced, maintained, dismantled or otherwise interfered with by any person not authorised by us.
- Any repair work must be undertaken by us or our appointed agent.
- Any parts removed during repair work or any appliance that is replaced become our property.
- The appliance is used in the United Kingdom or Republic of Ireland.

The guarantee does not cover:

- Damage resulting from transportation, improper use, neglect or interference or as a result of improper installation.
- Replacement of any consumable item or accessory. These include but are not limited to: plugs, cables, batteries, light bulbs, fluorescent tubes and starters, covers and filters.
- Replacement of any removable parts made of glass or plastic.

THE GUARANTEE WILL NOT APPLY IF THE APPLIANCE HAS BEEN USED IN COMMERCIAL OR NON-DOMESTIC PREMISES.

5 Year Parts Guarantee

Hotpoint also offers you a FREE 5 year parts guarantee. This additional guarantee is conditional on you registering your appliance with us and the parts being fitted by one of our authorised engineers. There will be a charge for our engineer's time. To activate the extra parts warranty on your appliance, simply call our registration line on **08448 24 24 24 (ROI 01 230 0800)**

Extended Guarantees

We offer a selection of protection plans that enable you to fully cover yourself against the expense of repair bills for the life of your policy. To find the ideal plan for you please call our advice line on **08448 226 226 (ROI 01 230 0233)**

Free Helpdesk Service

We have a dedicated team who can provide free advice and assistance with your appliance if you experience any technical difficulties within the first 90 days of ownership.

Simply call our Hotpoint Service Hotline on **08448 224 224 (ROI 0818 313 413)** for telephone assistance, or, where necessary, to arrange for an engineer to call.

After Sales Service

No one is better placed to care for your Hotpoint appliance during the course of its working life than us - the manufacturer.

Essential Contact Information

Hotpoint Service

We are the largest service team in the country offering you access to 400 skilled telephone advisors and 1100 fully qualified engineers on call to ensure you receive fast, reliable, local service.

UK: 08448 224 224

Republic of Ireland: 0818 313 413

www.hotpoint.co.uk

Please note: Our advisors will require the following information:

Model number

Serial number

Parts & Accessories

We supply a full range of genuine replacement parts as well as accessory products that protect and hygienically clean your appliance to keep it looking good and functioning efficiently throughout its life.

UK: 08448 225 225

Republic of Ireland: 0818 313 413

www.hotpointservice.co.uk

Appliance Registration

We want to give you additional benefits of Hotpoint ownership. To activate your FREE 5 year parts guarantee you must register your appliance with us.

UK 08448 24 24 24

Republic of Ireland: 01 230 0800

www.hotpointservice.co.uk

As part of Hotpoint's continued commitment to helping the environment, Hotpoint reserves the right to use quality, recycled components to keep down customer costs and minimise material wastage.

Indesit Company UK Limited, Morley Way, Peterborough, PE2 9JB

Indesit Company, Unit 49 Airways Industrial Estate, Dublin 17