

GB

English, 1

**BWA 81283**

### Contents

GB

#### **Installation, 2-3-4-5**

Unpacking and levelling  
Connecting the electricity and water supplies  
The first wash cycle  
Technical data

#### **Care and maintenance, 6**

Cutting off the water or electricity supply  
Cleaning the washing machine  
Cleaning the detergent dispenser drawer  
Caring for the door and drum of your appliance  
Cleaning the pump  
Checking the water inlet hose

#### **Precautions and tips, 7**

General safety  
Load balancing system  
Disposal

#### **Description of the washing machine and starting a wash cycle, 8-9**

Control panel  
Indicator lights  
Starting a wash cycle

#### **Wash cycles, 10**

Push & Wash  
Table of wash cycles

#### **Personalisation, 11**

Setting the temperature  
Setting the spin speed  
Functions

#### **Detergents and laundry, 12**

Detergent dispenser drawer  
Preparing the laundry  
Garments requiring special care

#### **Troubleshooting, 13-14**

#### **Product Guarantee and Repair Information, 15**

# Installation

GB

! This instruction manual should be kept in a safe place for future reference. If the washing machine is sold, transferred or moved, make sure that the instruction manual remains with the machine so that the new owner is able to familiarise himself/herself with its operation and features.  
! Read these instructions carefully: they contain vital information relating to the safe installation and operation of the appliance.

## Unpacking and levelling

### Unpacking

1. Remove the washing machine from its packaging.
2. Make sure that the washing machine has not been damaged during the transportation process. If it has been damaged, contact the retailer and do not proceed any further with the installation process.

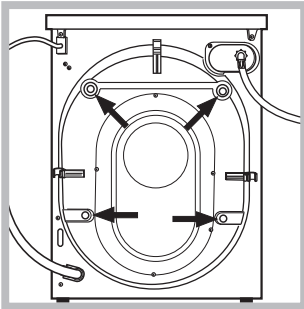

3. Remove the 4 protective screws (used during transportation) and the rubber washer with the corresponding spacer, located on the rear part of the appliance (see figure).

4. Close off the holes using the plastic plugs provided.
5. Keep all the parts in a safe place: you will need them again if the washing machine needs to be moved to another location.  
! Packaging materials should not be used as toys for children.

### Levelling

1. Install the washing machine on a flat sturdy floor, without resting it up against walls, furniture cabinets or anything else.

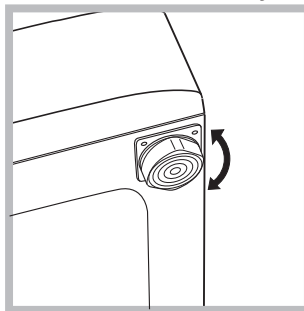

2. If the floor is not perfectly level, compensate for any unevenness by tightening or loosening the adjustable front feet (see figure); the angle of inclination, measured in relation to the worktop, must not exceed 2°.

Levelling the machine correctly will provide it with stability, help to avoid vibrations and excessive noise and prevent it from shifting while it is operating. If it is placed on carpet or a rug, adjust the feet in such a way as to allow a sufficient ventilation space underneath the washing machine.

## Connecting the electricity and water supplies

### Connecting the water inlet hose

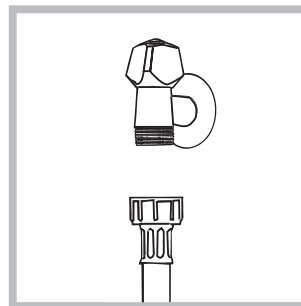

1. Connect the supply pipe by screwing it to a cold water tap using a 3/4 gas threaded connection (see figure).  
Before performing the connection, allow the water to run freely until it is perfectly clear.

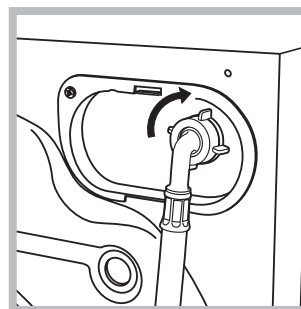

2. Connect the inlet hose to the washing machine by screwing it onto the corresponding water inlet of the appliance, which is situated on the top right-hand side of the rear part of the appliance (see figure).

3. Make sure that the hose is not folded over or bent.

! The water pressure at the tap must fall within the values indicated in the Technical details table (see page 5).

! If the inlet hose is not long enough, contact a specialised shop or an authorised technician.

! Never use second-hand hoses.

! Use the ones supplied with the machine.

## Connecting the drain hose

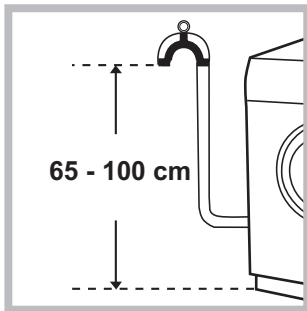

Connect the drain hose, without bending it, to a draining duct or a wall drain situated between 65 and 100 cm from the floor;

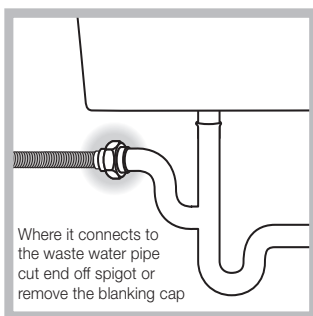

The drain hose may be connected to an under-sink trap. Before connecting the drain hose from the machine ensure that any blanks or removable ends have been taken off the spigot.

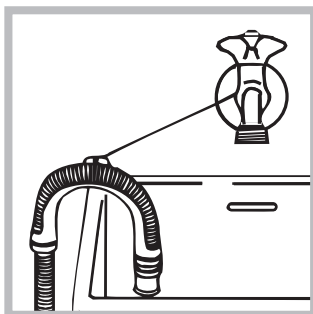

If it is placed over the edge of a basin or sink be sure the free end of the hose should not be underwater.

**!** We advise against the use of hose extensions; in case of absolute need, the extension must have the same diameter as the original hose and must not exceed 150 cm in length. Ensure that if the drain hose is pushed into a standpipe, that the end does not go down more than 15cms (6 inches). If the hose is pushed down too far, this may cause the machine to self-siphon ie. continuously empty as it is filling.

## Electric connection

Before plugging the appliance into the mains socket, make sure that:

- the socket is earthed and in compliance with the applicable law;
- the socket is able to sustain the appliance's maximum power load indicated on the Technical Data Plate fixed on the machine;

- the supply voltage is included within the values indicated on the Technical Data Plate fixed on the machine.

- the socket is compatible with the washing machine's plug. If this is not the case, replace the socket or the plug.

Your appliance is now supplied with a 13 amp fused plug it can be plugged into a 13 amp socket for immediate use. Before using the appliance please read the instructions below.

**WARNING - THIS APPLIANCE MUST BE EARTHED. THE FOLLOWING OPERATIONS SHOULD BE CARRIED OUT BY A QUALIFIED ELECTRICIAN.**

### *Replacing the fuse:*

When replacing a faulty fuse, a 13 amp ASTA approved fuse to BS 1362 should always be used, and the fuse cover re-fitted. If the fuse cover is lost, the plug must not be used until a replacement is obtained.

### *Replacement fuse covers:*

If a replacement fuse cover is fitted, it must be of the correct colour as indicated by the coloured marking or the colour that is embossed in words on the base of the plug. Replacements can be obtained directly from your nearest Service Depot.

### *Removing the plug:*

If your appliance has a non-rewireable moulded plug and you should wish to re-route the mains cable through partitions, units etc., please ensure that either:

the plug is replaced by a fused 13 ampere rewireable plug bearing the BSI mark of approval.

or:

the mains cable is wired directly into a 13 amp cable outlet, controlled by a switch, (in compliance with BS 5733) which is accessible without moving the appliance.

### *Disposing of the plug:*

Ensure that before disposing of the plug itself, you make the pins unusable so that it cannot be accidentally inserted into a socket.

Instructions for connecting cable to an alternative plug:

Important: the wires in the mains lead are coloured in accordance with the following code:

<b>Green &amp; Yellow</b>	<b>Earth</b>
<b>Blue</b>	<b>Neutral</b>
<b>Brown</b>	<b>Live</b>

As the colours of the wires in the lead may not correspond with the coloured markings identifying the terminals in your plug, proceed as follows:

Connect Green & Yellow wire to terminal marked E or  $\equiv$  or coloured Green or Green & Yellow.

Connect Brown wire to terminal marked L or coloured Red.

Connect Blue wire to terminal marked N or coloured Black.

If a 13 amp plug (BS 1363) is used it must be fitted with a 13 amp fuse, either in the plug or adaptor or at the distribution board.

If you are in any doubt regarding the electrical supply to your machine, consult a qualified electrician before use.

How to connect an alternative plug:

The wires in this mains lead are coloured in accordance with the following code:

**BLUE**  
**BROWN**  
**GREEN & YELLOW**

**NEUTRAL (N)**  
**LIVE (L)**  
**EARTH (E)**

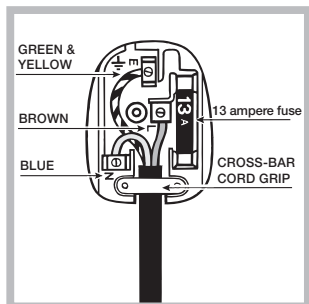

*Disposing of the appliance:*

When disposing of the appliance please remove the plug by cutting the mains cable as close as possible to the plug body and dispose of it as described above.

! The washing machine should not be installed in an outdoor environment, not even where the area is sheltered, because it may be very dangerous to leave it exposed to damp, rain and thunderstorms.

! When the washing machine is installed, the mains socket must be within easy reach.

! Do not use extensions or multiple sockets.

! The power supply cable must never be bent or dangerously compressed.

! The power supply cable must only be replaced by an authorised serviceman.

Warning! The company denies all liability if and when these norms are not respected.

**The first wash cycle**

Once the appliance has been installed, and before you use it for the first time, run a wash cycle with detergent and no laundry, using the wash cycle “Auto Clean” (see “Cleaning the washing machine”).

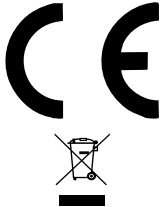
Technical data	
<b>Model</b>	BWA 81283
<b>Dimensions</b>	width 59.5 cm height 85 cm depth 60.5 cm
<b>Capacity</b>	from 1 to 8 kg
<b>Electrical connections</b>	please refer to the technical data plate fixed to the machine
<b>Water connections</b>	maximum pressure 1 MPa (10 bar) minimum pressure 0.05 MPa (0.5 bar) drum capacity 62 litres
<b>Spin speed</b>	up to 1200 rotations per minute
<b>Test wash cycles in accordance with regulations 1061/2010 and 1015/2010.</b>	Programme 9: Eco Cotton 60°. Programme 9: Eco Cotton 40°.
	This appliance conforms to the following EC Directives: - EMC 2014/30/EU (Electromagnetic Compatibility) - LVD 2014/35/EU (Low Voltage) - 2012/19/EU (WEEE)

<b>COMMISSION DELEGATED REGULATION (EU) No 1061/2010</b>	
Brand	INDESIT
Model	BWA 81283X W UK
Rated capacity in kg of cotton	8
Energy efficiency class on a scale from A+++ (low consumption) to G (high consumption)	A+++
Energy consumption per year in kWh <sup>1)</sup>	193
Energy consumption of the standard 60 °C cotton programme at full load in kWh <sup>2)</sup>	1.044
Energy consumption of the standard 60 °C cotton programme at partial load in kWh <sup>2)</sup>	0.715
Energy consumption of the standard 40 °C cotton programme at partial load in kWh <sup>2)</sup>	0.644
Power consumption of the off-mode in W	0.5
Power consumption of the left-on mode in W	8
Water consumption per year in litres <sup>3)</sup>	11594
Spin-drying efficacy class on a scale from G (minimum efficacy) to A (maximum efficacy)	B
Maximum spin speed attained <sup>4)</sup>	1200
Remaining moisture content <sup>5)</sup>	53.0%
Programme time of the "standard 60 °C cotton" at full load in minutes	215
Programme time of the "standard 60 °C cotton" at partial load in minutes	155
Programme time of the "standard 40°C cotton" at partial load in minutes	145
Duration of the left-on mode in minutes	30
Noise in dB(A) re 1 pW washing <sup>6)</sup>	52
Noise in dB(A) re 1 pW spinning <sup>6)</sup>	80
Built-in model	

<sup>1)</sup> The "standard 60°C cotton" at full and partial load and the "standard 40°C cotton" at partial load are the standard washing programmes to which the information in the label and the fiche relates. Standard 60°C cotton and standard 40°C cotton are suitable to clean normally soiled cotton laundry and are the most efficient programmes in terms of combined energy and water consumption. Partial load is half the rated load.

<sup>2)</sup> Based on 220 standard washing cycles for cotton programmes at 60°C and 40°C at full and partial load, and the consumption of the low-power modes. Actual energy consumption will depend on how the appliance is used.

<sup>3)</sup> Based on 220 standard washing cycles for cotton programmes at 60°C and 40°C at full and partial load. Actual water consumption will depend on how the appliance is used.

<sup>4)</sup> For the standard 60 °C at full and partial load or the 40°C at partial whichever is lower.

<sup>5)</sup> Attained for 60 °C cotton at full and partial load or the 40°C at partial whichever is higher.

<sup>6)</sup> Based on washing and spinning phases for the standard 60°C cotton programme at full load.

# Care and maintenance

GB

## Cutting off the water and electricity supplies

- Turn off the water tap after every wash cycle. This will limit wear on the hydraulic system inside the washing machine and help to prevent leaks.
- Unplug the washing machine when cleaning it and during all maintenance work.

## Cleaning the washing machine

- The outer parts and rubber components of the appliance can be cleaned using a soft cloth soaked in lukewarm soapy water. Do not use solvents or abrasives.
- The washing machine has a “Auto Clean” programme for its internal parts that **must be run with no load in the drum**.

For maximum performance you may want to use either the detergent (i.e. a quantity 10% the quantity specified for lightly-soiled garments) or special additives to clean the washing machine. We recommend running a cleaning programme every 40 wash cycles. To start the programme press buttons **A** and **B** simultaneously for 5 seconds (see figure). The programme will start automatically and will last approximately 70 minutes. To stop the cycle press the START/PAUSE button.

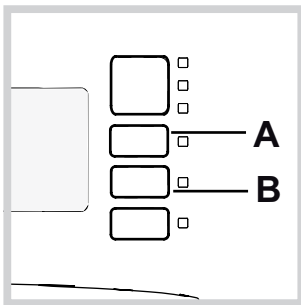

## Cleaning the detergent dispenser drawer

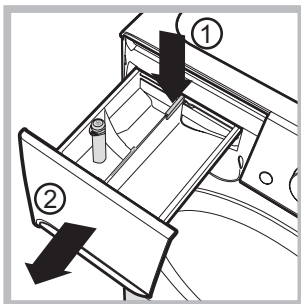

To remove the drawer, press lever (1) and pull the drawer outwards (2) (see figure). Wash it under running water; this procedure should be repeated frequently.

## Caring for the door and drum of your appliance

- Always leave the porthole door ajar in order to prevent unpleasant odours from forming.

## Cleaning the pump

The washing machine is fitted with a self-cleaning pump which does not require any maintenance. Sometimes, small items (such as coins or buttons) may fall into the protective pre-chamber at the base of the pump. **! Make sure the wash cycle has finished and unplug the appliance.**

To access the pre-chamber:

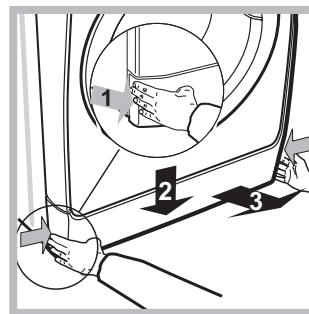

1. Take off the cover panel on the front of the machine by first pressing it in the centre and then pushing downwards on both sides until you can remove it (see figures).

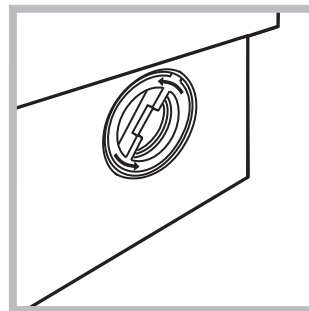

2. Unscrew the lid by rotating it anti-clockwise (see figure); a little water may trickle out. This is perfectly normal.

3. Clean the inside thoroughly.
4. Screw the lid back on.
5. Reposition the panel, making sure the hooks are securely in place before you push it onto the appliance.

## Checking the water inlet hose

Check the inlet hose at least once a year. If there are any cracks, it should be replaced immediately: during the wash cycles, water pressure is very strong and a cracked hose could easily split open.

**! Never use second-hand hoses.**

! This washing machine was designed and constructed in accordance with international safety regulations. The following information is provided for safety reasons and must therefore be read carefully.

## General safety

- This appliance was designed for domestic use only.
- This appliance can be used by children aged from 8 years and above and persons with reduced physical, sensory or mental capabilities or lack of experience and knowledge if they have been given supervision or instruction concerning use of the appliance in a safe way and understand the hazards involved. Children shall not play with the appliance. Cleaning and user maintenance shall not be made by children without supervision.
- The washing machine must only be used by adults, in accordance with the instructions provided in this manual.
- Do not touch the machine when barefoot or with wet or damp hands or feet.
- Do not pull on the power supply cable when unplugging the appliance from the electricity socket. Hold the plug and pull.
- Do not open the detergent dispenser drawer while the machine is in operation.
- Do not touch the drained water as it may reach extremely high temperatures.
- Never force the porthole door. This could damage the safety lock mechanism designed to prevent accidental opening.
- If the appliance breaks down, do not under any circumstances access the internal mechanisms in an attempt to repair it yourself.
- Always keep children well away from the appliance while it is operating.
- The door can become quite hot during the wash cycle.
- If the appliance has to be moved, work in a group of two or three people and handle it with the utmost care. Never try to do this alone, because the appliance is very heavy.
- Before loading laundry into the washing machine, make sure the drum is empty.

## Load balancing system

Before every spin cycle, to avoid excessive vibrations and to distribute the load in a uniform manner, the drum rotates continuously at a speed which is slightly greater than the washing rotation speed. If, after several attempts, the load is not balanced correctly, the machine spins at a reduced spin speed. If the load is excessively unbalanced, the washing machine performs the distribution process instead of spinning. To encourage improved load distribution and balance, we recommend small and large garments are mixed in the load.

## Disposal

- Disposing of the packaging materials: observe local regulations so that the packaging may be re-used.
- The European Directive 2012/19/EU - WEEE on Waste Electrical and Electronic Equipment, requires that old household electrical appliances must not be disposed of in the normal unsorted municipal waste stream. Old appliances must be collected separately in order to optimise the recovery and recycling of the materials they contain and reduce the impact on human health and the environment. The crossed out “wheeled bin” symbol on the product reminds you of your obligation, that when you dispose of the appliance it must be separately collected.  
Consumers should contact their local authority or retailer for information concerning the correct disposal of their old appliance.

# Description of the washing machine and starting a wash cycle

## Control panel

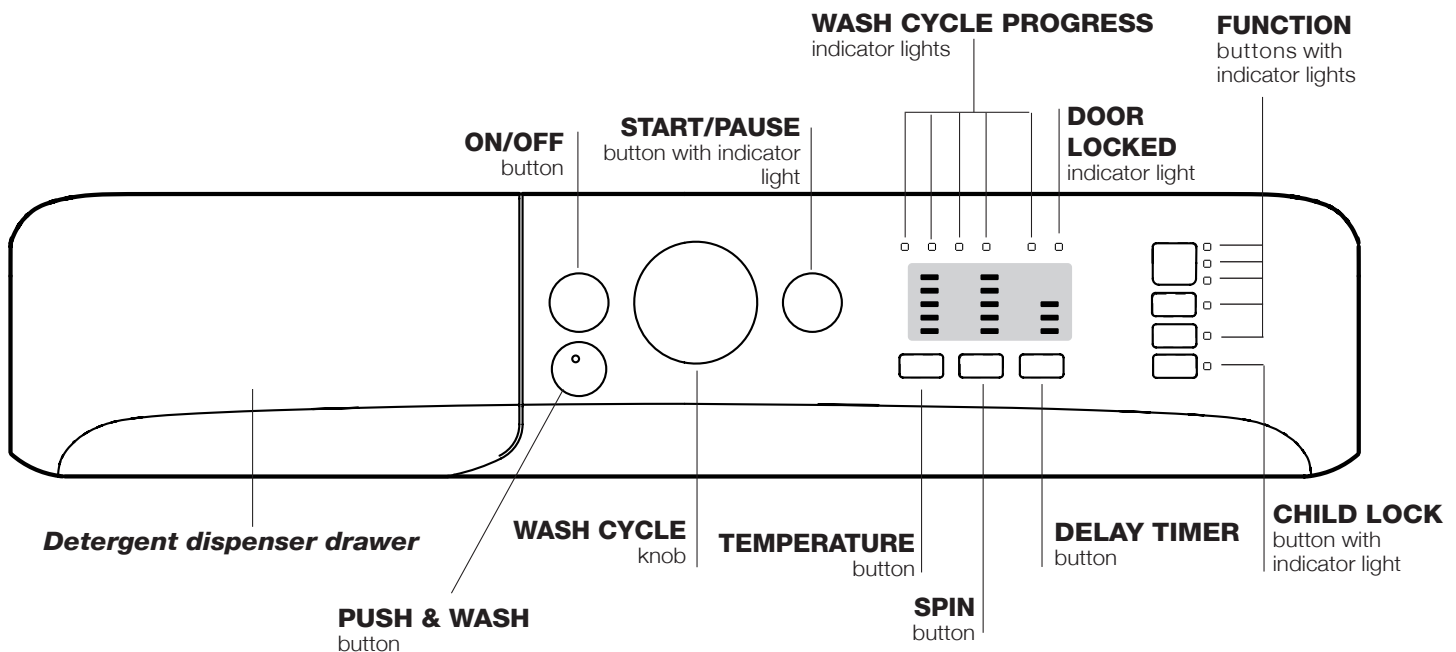

**Detergent dispenser drawer:** used to dispense detergents and washing additives (see “Detergents and laundry”).

**ON/OFF button:** switches the washing machine on and off.

**PUSH & WASH button:** (see “Wash cycles”).

**WASH CYCLE knob:** programmes the wash cycles. During the wash cycle, the knob does not move.

**FUNCTION buttons with indicator light:** used to select the available functions. The indicator light corresponding to the selected function will remain lit.

**CHILD LOCK button with indicator light:** to activate the control panel lock, press and hold the button for approximately 2 seconds. When the symbol  is illuminated, the control panel is locked (apart from the ON/OFF button). This means it is possible to prevent wash cycles from being modified accidentally, especially where there are children in the home. To deactivate the control panel lock, press and hold the button for approximately 2 seconds.

**TEMPERATURE button:** sets the temperature or the cold wash cycle (see “Personalisation”).

**SPIN button:** sets the spin speed or exclude the spin cycle completely (see “Personalisation”).

**DELAY TIMER button:** delays the start of the wash cycle by up to 9 hours. Press the button repeatedly until the indicator light corresponding to the desired delay time turns on. When the button is pressed for the fourth time, the option will be deactivated.

**N.B.:** once the START/PAUSE button has been pressed, the delay time can only be modified by decreasing it until the set programme is launched.

! This option is available on all programmes.

**WASH CYCLE PROGRESS indicator lights:** used to monitor the progress of the wash cycle. The illuminated indicator light shows which phase is in progress.

**DOOR LOCKED indicator light:** indicates whether the door may be opened or not (see next page).

**START/PAUSE button with indicator light:** starts or temporarily interrupts the wash cycles.

**N.B.** To pause the wash cycle in progress, press this button; the corresponding indicator light will flash orange, while the indicator light for the current wash cycle phase will remain lit in a fixed manner. If the DOOR LOCKED  indicator light is switched off, the door may be opened (wait approximately 3 minutes).

To start the wash cycle from the point at which it was interrupted, press this button again.

### Standby mode

This washing machine, in compliance with new energy saving regulations, is fitted with an automatic standby system which is enabled after about 30 minutes if no activity is detected. Press the ON-OFF button briefly and wait for the machine to start up again.



## Indicator lights

The indicator lights provide important information. This is what they can tell you:

### Delayed start

If the DELAY TIMER function has been activated (see “Personalisation”), after the wash cycle has been started the indicator light corresponding to the selected delay period will begin to flash:

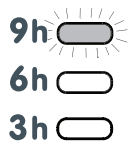

As time passes, the remaining delay will be displayed and the corresponding indicator light will flash:

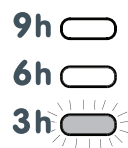

The set programme will start once the selected time delay has expired.

## Starting a wash cycle

### Rapid programming

- LOAD THE LAUNDRY.** Open the porthole door. Load the laundry, making sure you do not exceed the maximum load value indicated in the table of programmes and wash cycles on the following page.
- ADD THE DETERGENT.** Pull out the detergent dispenser drawer and pour the detergent into the relevant compartments as described in “Detergents and laundry”.
- CLOSE THE DOOR.**
- Press the “PUSH & WASH” button to start the wash programme.

### Traditional programming

- Turn the washing machine on by pressing the ON/OFF button. All the indicator lights will turn on for a few seconds, then only the indicator lights relative to the selected programme settings will remain lit and the START/PAUSE indicator light will flash.

### Wash cycle phase indicator lights

Once the desired wash cycle has been selected and has begun, the indicator lights switch on one by one to indicate which phase of the cycle is currently in progress.

Wash	
Rinse	
Spin	
Drain	
End of wash cycle	

### Function buttons and corresponding indicator lights

When a function is selected, the corresponding indicator light will illuminate.



If the selected function is not compatible with the programmed wash cycle, the corresponding indicator light will flash and the function will not be activated.

If the selected option is not compatible with another previously selected option, the indicator light will flash accompanied by a buzzer (3 beeps), and only the latter option will be activated; the indicator light corresponding to the activated option will turn on.

### Door locked indicator light

When the indicator light is on, the porthole door is locked to prevent it from being opened; make sure the indicator light is off before opening the door (wait approximately 3 minutes).

To open the door during a running wash cycle, press the START/PAUSE button; the door may be opened once the DOOR LOCKED indicator light turns off.

- Load the laundry and close the door.
- Set the WASH CYCLE knob to the desired programme.
- Set the washing temperature (see “Personalisation”).
- Set the spin speed (see “Personalisation”).
- Measure out the detergent and washing additives (see “Detergents and laundry”).
- Select the desired functions.
- Start the wash cycle by pressing the START/PAUSE button and the corresponding indicator light will remain lit in a fixed manner in green. To cancel the set wash cycle, pause the machine by pressing the START/PAUSE button and select a new cycle.
- At the end of the wash cycle the  indicator light will switch on. The door can be opened once the DOOR LOCK  indicator light turns off (wait approximately 3 minutes). Take out your laundry and leave the appliance door ajar to make sure the drum dries completely. Switch the washing machine off by pressing the ON/OFF button.

# Wash cycles

GB

## Push & Wash

This function allows for starting a wash cycle even when the machine is switched off without having to press the ON/OFF button in advance, or after switching on the machine, without having activated any button and/or selector (otherwise, the Push & Wash function will be deactivated). To start the Push & Wash cycle press and hold the relative button for 2 seconds. The lit indicator light indicates that the cycle has started. This wash cycle is ideal for cotton or synthetic fabrics, as it washes at a temperature of 30° and a maximum spin speed of 1000 rpm. Maximum load 4 kg. (Cycle duration 45').

### How does it work?







1. Load the laundry (cotton and/or synthetic garments) and close the door.
2. Pour the detergent and additives.
3. Start the programme by pressing and holding the Push & Wash button for 2 seconds. The relative indicator light turns green and the door will lock (the DOOR LOCKED symbol turns on).

**N.B.:** starting the wash cycle through the Push & Wash button activates an automatic non-customisable cycle recommended for cotton and synthetic fabrics. This programme does not allow for setting any additional options.

To open the door while an automatic cycle is under way, press the START/PAUSE button; if the DOOR LOCKED symbol is switched off the door may be opened. Press the START/PAUSE button again to restart the wash cycle from the point at which it was interrupted.

4. Once the programme is finished, the  indicator light turns on.

## Table of wash cycles

Wash cycles	Description of the wash cycle	Max. temp. (°C)	Max. speed (rpm)	Detergents		Max. load (kg)	Residual dampness %	Energy consumption kWh	Total water lt	Cycle duration
				Wash	Fabric softener					
<b>Everyday 30° ECO</b>										
1	Daily cotton	30°	1200	●	●	4	-	-	-	100'
2	Daily synthetics	30°	1000	●	●	4.5	-	-	-	90'
3	Coloureds	30°	1000	●	●	4	-	-	-	95'
4	Delicates	30°	0	●	●	1	-	-	-	80'
5	Rapid 30min: to refresh lightly soiled garments quickly (not suitable for wool, silk and clothes which require washing by hand).	30°	800	●	●	4.5	70	0.18	42	30'
<b>Traditionals</b>										
6	Cotton (3): lightly soiled whites and delicate colours.	40° (Max.60°)	1200	●	●	8	53	1.03	92	220'
7	Synthetics (4): lightly soiled resistant colours.	40° (Max.60°)	1000	●	●	4.5	46	0.74	59	125'
8	Mixed	40°	1200	●	●	8	-	-	-	105'
9	 Eco cotton 60°C (1): heavily soiled whites and resistant colours.	60°	1200	●	●	8	53	1.04	55.0	215'
9	 Eco cotton 40°C (2): lightly soiled whites and delicate colours.	40°	1200	●	●	8	53	1.03	92	220'
10	White cotton: heavily soiled whites and resistant colours.	60° (Max.90°)	1200	●	●	8	-	-	-	200'
<b>Specials</b>										
11	Sport	30°	600	●	●	4	-	-	-	60'
12	Duvet: for down-stuffed garments.	30°	1000	●	●	3.5	-	-	-	115'
13	Wool: for wool, cashmere, etc.	40°	800	●	●	2	-	-	-	85'
14	Anti odour	40°	1000	●	●	3.5	-	-	-	105'
	Rinse + Spin	-	1200	-	●	8	-	-	-	55'
	Spin + Drain	-	1200	-	-	8	-	-	-	10'
	Drain only *	-		-	-	8	-	-	-	3'

\* If you select programme  and exclude the spin cycle, the machine will drain only.

The length of cycle shown on the display or in this booklet is an estimation only and is calculated assuming standard working conditions. The actual duration can vary according to factors such as water temperature and pressure, the amount of detergent used, the amount and type of load inserted, load balancing and any wash options selected.

**1) Test wash cycle in compliance with regulation 1061/2010: set wash cycle 9 with a temperature of 60°C.**

This cycle is designed for cotton loads with a normal soil level and is the most efficient in terms of both electricity and water consumption; it should be used for garments which can be washed at 60°C. The actual washing temperature may differ from the indicated value.

**2) Test wash cycle in compliance with regulation 1061/2010: set wash cycle 9 with a temperature of 40°C.**

This cycle is designed for cotton loads with a normal soil level and is the most efficient in terms of both electricity and water consumption; it should be used for garments which can be washed at 40°C. The actual washing temperature may differ from the indicated value.

For all Test Institutes:

3) Long wash cycle for cottons: set wash cycle 6 with a temperature of 40°C.

4) Synthetic program along: set wash cycle 7 with a temperature of 40°C.

## Setting the temperature

Press the TEMPERATURE button to set the wash temperature (see *Table of wash cycles*).

The temperature may be lowered, or even set to a cold wash (20°).

The washing machine will automatically prevent you from selecting a temperature which is higher than the maximum value set for each wash cycle.

! Exception: if the **6** programme is selected, the temperature can be increased up to a value of 60°C.

! Exception: if the **7** programme is selected, the temperature can be increased up to a value of 60°C.

! Exception: if the **10** programme is selected, the temperature can be increased up to a value of 90°C.

## Setting the spin speed

Press the SPIN SPEED button to set the spin speed for the selected wash cycle.

The maximum spin speeds available for each wash cycle are as follows:

Wash cycles	Maximum spin speed
Cottons	1200 rpm
Synthetics	1000 rpm
Wool	800 rpm

The spin speed may be lowered, or the spin cycle can be excluded altogether by selecting the symbol .

The washing machine will automatically prevent you from selecting a spin speed which is higher than the maximum speed set for each wash cycle.

## Functions

The various wash functions available with this washing machine will help to achieve the desired results, every time.

To activate the functions:

1. Press the button corresponding to the desired function;
2. the function is enabled when the corresponding indicator light is illuminated.



**Note:**

- If the selected function is not compatible with the programmed wash cycle, the corresponding indicator light will flash and the function will not be activated.
- If the selected option is not compatible with another previously selected option, the indicator light will flash accompanied by a buzzer (3 beeps), and only the latter option will be activated; the indicator light corresponding to the activated option will turn on.



### Stain removal

This option allows for selecting the type of dirt so as to optimally adjust the cycle for removing the stains. The following types of dirt can be selected:

-  **Food**, for stains caused by foodstuffs and beverages, for example.
-  **Work**, for grease and ink stains, for example.
-  **Outdoor**, for mud and grass stains, for example.

! The wash cycle duration varies according to the type of selected dirt.



### Extra Rinse

By selecting this option, the efficiency of the rinse is increased and optimal detergent removal is guaranteed. It is particularly useful for sensitive skin.



### Easy iron

By selecting this function, the wash and spin cycles will be modified in order to reduce the formation of creases. At the end of the cycle the washing machine will perform slow rotations of the drum, while the EASY IRON and START/PAUSE indicator lights will flash and the  led will remain lit in a fixed manner. To end the cycle, press the START/PAUSE button or the EASY IRON button.

# Detergents and laundry

GB

## Detergent dispenser drawer

Successful washing results also depend on the correct dose of detergent: adding too much detergent will not necessarily result in a more efficient wash, and may in fact cause build up on the inside of your appliance and contribute to environmental pollution.

! Do not use hand washing detergents because these create too much foam.

! Use powder detergent for white cotton garments, for pre-washing, and for washing at temperatures over 60°C.

! Follow the instructions given on the detergent packaging.

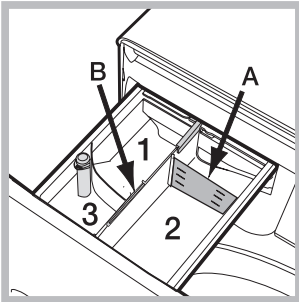

Open the detergent dispenser drawer and pour in the detergent or washing additive, as follows.

**Compartment 1:** Do not pour detergent into the middle compartment 1.

**Compartment 2: Washing detergent (powder or liquid)**

If liquid detergent is used, it is recommended that the removable plastic partition **A** (supplied) be used for proper dosage. If powder detergent is used, place the partition into slot **B**.

**Compartment 3: Additives (fabric softeners, etc.)**

The fabric softener must not exceed the "max" level indicated on the central pin.

## Preparing the laundry

- Divide the laundry according to:
  - the type of fabric/the symbol on the label
  - the colours: separate coloured garments from whites.
- Empty all garment pockets and check the buttons.
- Do not exceed the values listed in the "Table of wash cycles", which refer to the weight of the laundry when dry.

## How much does your laundry weigh?

- 1 sheet 400-500 g
- 1 pillow case 150-200 g
- 1 tablecloth 400-500 g
- 1 bathrobe 900-1.200 g
- 1 towel 150-250 g

## Garments requiring special care

**Daily cotton:** a 30°C cycle for cotton garments. It allows for reducing consumption of energy for heating the water, while guaranteeing excellent results. Suitable for lightly soiled garments.

**Daily synthetics:** a 30°C cycle for synthetic garments. It allows for reducing consumption of energy for heating the water, while guaranteeing excellent results. Suitable for lightly soiled garments.

**Coloureds:** a 30°C cycle that helps to preserve the colours; suitable for coloured cotton and synthetic garments. It allows for reducing consumption of energy for heating the water, while guaranteeing excellent results. Suitable for lightly soiled garments.

**Delicates:** use programme **4** to wash very delicate garments. It is advisable to turn the garments inside out before washing them. For best results, use liquid detergent on delicate garments. For washing Silk items and Curtains, select the relevant cycle and activate the option ; the machine will end the cycle with the laundry soaked and the indicator light will flash. To drain the water so that the laundry can be removed, press the START/PAUSE button ro the option .

**Mixed:** a 40°C cycle for washing cotton and synthetic garments together. Suitable for lightly soiled underwear.

**Sport** (programme **11**) is designed for washing lightly soiled sports clothing (tracksuits, shorts, etc.); for best results, we recommend not exceeding the maximum load indicated in the "Programme table". We recommend using liquid detergent, and adding the amount suitable for a half-load.

**Duvet:** to wash double or single duvets (the weight of which should not exceed 3,5 kg), cushions or clothes padded with goose down such as puffer jackets, use the special wash programme number **12**. We recommend that duvets are placed in the drum with their edges folded inwards (see figure) and that no more than  $\frac{3}{4}$  of the total volume of the drum is used. To achieve the best results, we recommend that a liquid detergent is used and placed inside the detergent dispenser drawer.

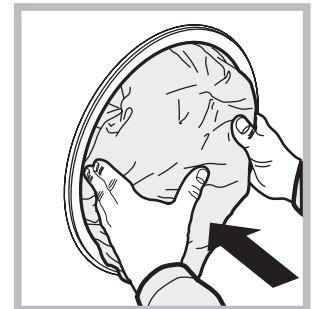

## Wool - Woolmark Apparel Care - Blue:

the wool wash cycle of this machine has been approved by The Woolmark Company for the washing of wool garments labelled as "hand wash" provided that the products are washed according to the instructions on the garment label and those issued by the manufacturer of this washing machine. (M1127)



In UK, Eire, Hong Kong and India the Woolmark trade mark is a Certification trade mark.

**Anti odour:** use programme **14** (Synthetics) for washing garments with bad odours (e.g. smoke, sweat, fried food). The programme is designed to remove bad odours while preserving the fabric fibres.

Your washing machine could fail to work. Before contacting the Technical Assistance Centre (see "Assistance"), make sure that the problem cannot be solved easily using the following list.

## Problem:

## Possible causes / Solutions:

### The machine does not switch on.

- The appliance is not plugged into the socket fully, or not enough to make contact.
- There is no power to the socket, or the fuse has blown in the mains plug.

### The wash cycle does not start.

- The door is not closed properly.
- The ON/OFF button has not been pressed.
- The START/PAUSE button has not been pressed.
- The water tap has not been turned on to allow water to flow into the machine.
- A delayed start has been set.

### The machine does not fill with water or the indicator light for the first wash cycle stage flashes rapidly.

- The water inlet hose is kinked.
- The water inlet hose is not connected to the water supply.
- The water pressure is too low.
- The water tap has not been turned on to allow water to flow into the machine.
- There is no water supply to the house.
- The inlet valve filter is blocked.
- The START/PAUSE button has not been pressed.

### The machine continuously fills with water and continually drains away or Water left in the drum or Stuck on wash.

- The top of the drain hose is too low - It must be fitted at a height between 65 and 100 cm from the floor (see "Installation").
- The drain hose is connected incorrectly to the sink trap allowing water to run into the machine, the drain hose must be positioned higher than the bottom of the sink to prevent water flowing down the drain hose.
- The end of the drain hose has been pushed too far down the standpipe, the 'U' bracket should be fitted 100 mm from the end of the drain hose.



### The machine does not drain or spin - ( error lights flashing ).

- The Pump filter is blocked.
- The drain hose is kinked (see "Installation").
- New Installation - The blanking cap or spigot has not been removed if connected under a sink.
- The drain hose or sink trap is blocked.

### The machine does spin

- The Spin Speed is set to .

### The machine does not drain or spin - & 'START/PAUSE' indicator lights flash.

- If the  option is enabled, at the end of the program the machine drum will rotate slowly. To complete the program press the 'START/PAUSE' or the  buttons.

### The programme takes too long.

- Programme times will vary due to water pressure, the incoming water temperature and if the wash load goes out of balance. This will increase the programme times accordingly (see 'The machine wont spin properly' next page).

### The machine vibrates a lot during the spin cycle.

- The feet have not been adjusted, enabling the machine to rock.
- New Installation - Either the Transit Bolts including the plastic spacers, or the Polystyrene Packaging have not been removed when installing the machine.
- The machine is trapped between cabinets and/or walls.
- The load is in a slight out of balance condition and machine is spinning, but at a lower speed.

**The machine is noisy.**

- There will always be some motor, pump and drum noise during spin.

**The machine wont spin properly.**

- Out of Balance detected when attempting to go into a spin cycle - If this happens the machine will continue to try to repeat the distribution of the load required before the machine will go into higher spin speeds - This will increase the programme time accordingly. This is a safety feature to prevent damage. Out of Balance can be caused by washing a single heavy item (eg duvet, quilt, etc). - Try the programme again using a different load.

**The machine leaks from the dispenser.**

- The dispenser drawer is blocked with detergent and requires cleaning.
- The water pressure is too high and requires turning down - turn down the tap on the water supply pipe slightly and try again.
- The machine is tilting forwards - It must be level when in its final position.

**The machine leaks (other than dispenser).**

- The fill hose is loose, check both the cabinet and tap ends.
- The fill hose is tight but still leaks, if so replace the rubber washers, or the fill hose is missing the rubber washer.
- The drain hose is not fixed in properly.

**The function lights and the START/ PAUSE indicator light flash while one of the wash cycle progress and DOOR LOCKED lights are lit in a fixed manner.**

- Switch off the machine and unplug it, wait for approximately 1 minute and then switch it back on again If the problem persists contact the Technical Assistance Service.

**The machine smells.**

- The machine requires a service wash. Run a "Auto Clean" wash cycle with detergent and no laundry.

**The machine door cannot be opened.**

- The door will not open until the door lock indicator light goes out shortly after the program has finished.
- If there is no power to the machine you need to perform the manual unlocking procedure.

**Door Seal damaged at the bottom.**

- The door seal has drainage holes at the bottom - This is normal.

**The water level is too low when the machine is washing.**

- The water level is correct if it can be seen at the bottom of the door.

**There is too much foam.**

- The detergent is not suitable for machine washing (it should display the text 'for washing machines' or 'hand and machine wash' or the like).
- Too much detergent was used - less detergent is required in soft water.

**After completing the programme, or before starting a programme, the machine has turned itself off (no lights).**

- To comply with new energy saving regulations the machine is fitted with an automatic standby system. Press 'ON/OFF' button for 3 seconds to activate the machine, it can then either be switched off or a new programme selected.

**General.**

- Your washing machine contains sensors that monitor progress during the wash cycle (eg: Water Levels, Temperatures, Out of Balance loads, Wash time/progress). Normally, if your machine successfully completes the cycle, there is unlikely to be anything wrong!

**Remember, you will be charged for a service call for problems caused by incorrect installation, as indicated on pages 2 to 4.**

**Not emptying contents from pockets may cause pump or drain blockages, or may damage the machine. Do not wash items which do not have a wash label, or wash items that are not intended as machine washable.**

## Guarantee

### 12 Months Parts and Labour Guarantee

Your appliance has the benefit of our manufacturer's guarantee, which covers the cost of breakdown repairs for twelve months from the date of purchase. This gives you the reassurance that if, within that time, your appliance is proven to be defective because of either workmanship or materials, we will, at our discretion, either repair or replace the appliance at no cost to you:

This guarantee is subject to the following conditions:

- The appliance has been installed and operated correctly and in accordance with our operating and maintenance instructions.
- The appliance is used only on the electricity or gas supply printed on the rating plate.
- The appliance has been used for normal domestic purposes only.
- The appliance has not been altered, serviced, maintained, dismantled, or otherwise interfered with by any person not authorised by us.
- Any repair work must be undertaken by us or our appointed agent.
- Any parts removed during repair work or any appliance that is replaced become our property.
- The appliance is used in the United Kingdom or Republic of Ireland.

The guarantee does not cover:

- Damage resulting from transportation, improper use, neglect or interference or as a result of improper installation.
- Replacement of any consumable item or accessory. These include but are not limited to: plugs, cables, batteries, light bulbs, fluorescent tubes and starters, covers and filters.
- Replacement of any removable parts made of glass or plastic.

THIS GUARANTEE WILL NOT APPLY IF THE APPLIANCE HAS BEEN USED IN COMMERCIAL OR NON-DOMESTIC PREMISES.

## Recycling and Disposal Information

As part of Indesit's continued commitment to helping the environment, Indesit reserves the right to use quality, recycled components to keep down customer costs and minimise material wastage. Please dispose of packaging and old appliances carefully. To minimise the risk of injury to children, remove the door, plug, and cut the mains cable off flush with the appliance. Dispose of these parts separately to ensure that the appliance can no longer be plugged into mains socket, and the door cannot be locked shut.

## Repairs and After Sales

For product help and advice, repairs, spare parts or accessories, we're here to help.

For local repair engineers - **03448 111 606**  
ROI - **0818 313 413**

UK standard local rate applies  
ROI local Irish rate applies

For Parts and Accessories visit:  
**parts.indesit.co.uk/shop**

Please remember to register your appliance at **www.indesitservice.co.uk** to activate your 10 year parts guarantee.

How to find your model and serial number:

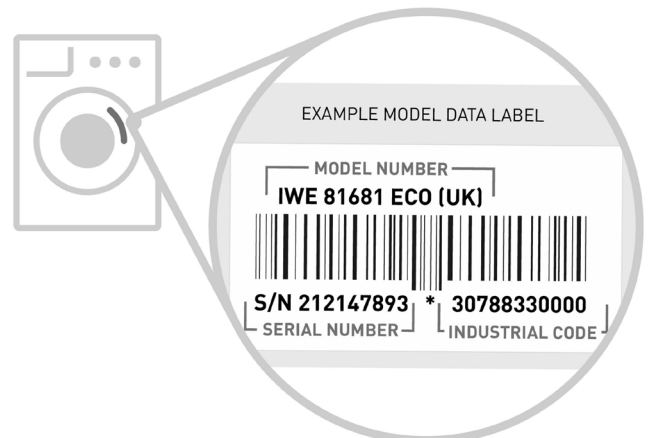

GB

Indesit Company Spa  
Viale Aristide Merloni, 47  
60044 Fabriano (AN)  
Italy  
[www.indesit.co.uk](http://www.indesit.co.uk)