

BUSH

Instruction manual

Dual Fuel Range Cooker

5555440 BFCX100DFC

5544334 BFCX100DFSS

6222064 BFCX100DFB





You'll soon be enjoying your new Dual Fuel Range
Cooker

It all begins here, with your instructions. Don't worry,
there's nothing too technical coming up. Just simple,
step-by-step guidance to get you up and running
quickly. Sound good? Then let's get started.

Help and Guidance

We're here to help you get the most from your Dual Fuel Range Cooker. Should you
require any guidance, a simple solution can often be found online at:

www.argos-support.co.uk

If you still require further assistance, call one of our experts on **01759 487838**.

Contents

1 Safety information

Safety information 5

2 Getting to know your Dual Fuel Range Cooker

Ready? Let's begin 8

Accessories 9

3 Installing your Dual Fuel Range Cooker

Installation requirements 11

Unpacking 11

Connections (electrical, water, gas) 12

4 Using your Dual Fuel Range Cooker

First use of Dual Fuel Range Cooker 14

Standard and advanced functions/use 18

5 Care and Maintenance

Cleaning 20

Maintenance actions 20

Technical specifications 21

6 Product support

Troubleshooting 23

Help and assistance 24

Declaration of conformance to product standards 25

Disposal 25

Guarantee 26

Safety information 1

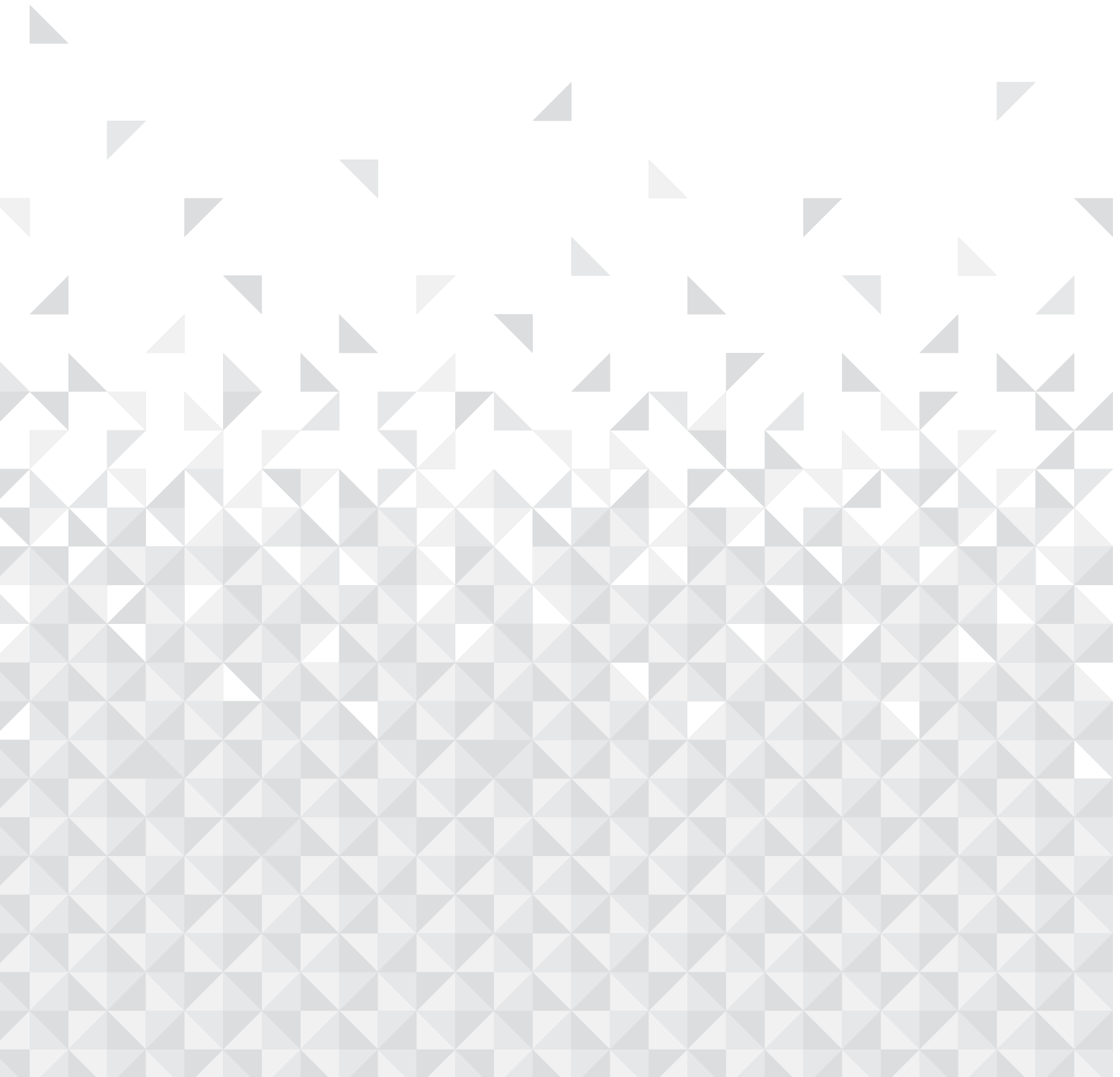



Safety information

Important - Please read these instructions fully before installing or operating

INSTALLATION WARNINGS

IMPORTANT: This product **MUST** be installed by a qualified Gas Safe registered installer in accordance with local regulations. Particular attention should be given to the ventilation requirements.

IMPORTANT: Prior to Installation ensure that the local supply conditions (gas type and pressure, electricity voltage and frequency) are compatible with the requirements of your cooker

IMPORTANT: Carefully unpack and examine the appliance for any damage. If you think there is a defect, do not use the appliance and contact Argos Product Support on **01759 487838**. Packaging materials should be collected together and disposed of immediately as they may be harmful to children.

IMPORTANT: Keep the electrical cable (not supplied) of your cooker away from the hot areas of your cooker; do not let the cable touch the appliance. Keep the cable away from sharp edges and heated surfaces.

IMPORTANT: Ensure that the electric supply cable is not trapped or damaged during installation.

IMPORTANT: In the event that the cable connecting your cooker becomes damaged, it must be replaced by a suitably qualified person.

This cable must not be replaced by an unauthorised person.

IMPORTANT: Protect your cooker against atmospheric effects. Do not expose your cooker to effects such as sun, rain, snow etc.

IMPORTANT: The materials surrounding the appliance (cabinets) must be able to withstand a minimum temperature of 100°C

IMPORTANT: When using your oven for the first time your cooker may give off an unusual odour from the heating elements and insulation materials. This is normal for new cookers. To eliminate this odour run the oven at 250 degrees for 40-60 mins with the oven empty.

DURING USAGE

IMPORTANT: Children and persons with reduced physical, sensory or mental capabilities or lack of experience and knowledge should not be allowed to use the cooker unless supervised and warned of the hazards involved

WARNING: The appliance and its accessible parts become hot during use. Care should be taken to avoid touching hot parts.

WARNING: Cooking on a hob with fat or oil can be dangerous and should not be left unattended.

WARNING: NEVER try to extinguish a cooking fire with water. Instead switch off the appliance and cover flame e.g. with a lid or a fire blanket.

CAUTION: Cookers may topple forward if a child climbs onto the cooker door. Children should be supervised in the kitchen at all times and this cooker must be secured to the wall using the fixing points provided to prevent accidents.

CAUTION: Do not allow children in the kitchen when cooking or while cooker parts may still be hot. Many parts of the cooker will become hot and present a considerable hazard to children.

CAUTION: When the oven is hot never touch the oven glass by hand or with tools.

CAUTION: Before starting to use your appliance, ensure curtains, paper or flammable items are kept away from your appliance. Do not keep flammable materials inside of or around your cooker.

CAUTION: Take care when closing the oven door that there is nothing obstructing it from closing as this may break the glass door.

IMPORTANT: When using the grill the oven door must be kept closed.

IMPORTANT: Position pans over the centre of the burners and turn handles to a safe position where they can not be knocked or grabbed.



Safety information

Important - Please read these instructions fully before installing or operating

IMPORTANT: Make sure the cooker control knobs are all in the off position when not in use

IMPORTANT: If you do not intend to use your cooker for a long period of time turn off the gas and electric supply to the cooker

CAUTION: Using gas cooking appliances results in the production of heat, moisture and the products of combustion. Ensure that the room where your cooker is installed is well ventilated particularly while the cooker is in use. Keep natural ventilation holes open or install a mechanical ventilation device (extractor hood) Prolonged intensive use of your cooker may call for additional ventilation (by opening a window) or by increasing the level of mechanical ventilation where present.

GENERAL SAFETY WARNINGS

IMPORTANT: This appliance has been designed for non-professional, domestic use only. Do not use this cooker for commercial use or any other application e.g. room heating

WARNING: Danger of fire: do not store flammable items on or near the cooking surfaces or inside the oven.

IMPORTANT: Do not try to lift or move this cooker by pulling on the door handle

WARNING: Ensure that the appliance is switched off before replacing the lamp to avoid the possibility of electric shock.

IMPORTANT: Your appliance is produced in accordance with all applicable local and international standards and regulations.

IMPORTANT: Maintenance and repair work must only be performed by authorized service technicians.

Installation and repair work that is carried out by unauthorised technicians is dangerous and could invalidate your guarantee

IMPORTANT: When the door of the oven is open, do not hang or lean anything on it. You may unbalance your appliance or damage the door or door hinges.

IMPORTANT: Do not hang towels, dishcloths or clothes from the cooker or its handles.

CLEANING AND MAINTENANCE

IMPORTANT: Always turn the appliance off before operations such as cleaning or maintenance. You can do this by switching the cooker off using the cooker isolation switch.

IMPORTANT: Do not remove the control knobs to clean the control panel.

TO MAINTAIN THE EFFICIENCY AND SAFETY OF YOUR APPLIANCE,
WE RECOMMEND YOU ALWAYS USE
OUR AUTHORIZED SERVICE AGENTS AND
ORIGINAL SPARE PARTS.

FOR ASSISTANCE CALL
ARGOS PRODUCT SUPPORT
01759 487838.



Getting to know your Dual Fuel Range Cooker

2



Getting to know your Dual Fuel Range Cooker

You'll be up and running in no time

Ready? Let's begin...

Please read these instructions carefully. They contain important information which will help you get the best from your Dual Fuel Range Cooker and ensure safe and correct installation and operation.

If you require any further assistance, our technical experts are happy to help. For full details, refer to the product support section at the end of these instructions.

If you require any technical guidance or find that your product is not operating as intended, a simple solution can often be found in the **Troubleshooting** section of these instructions.

Getting to know your Dual Fuel Range Cooker

You'll be up and running in no time

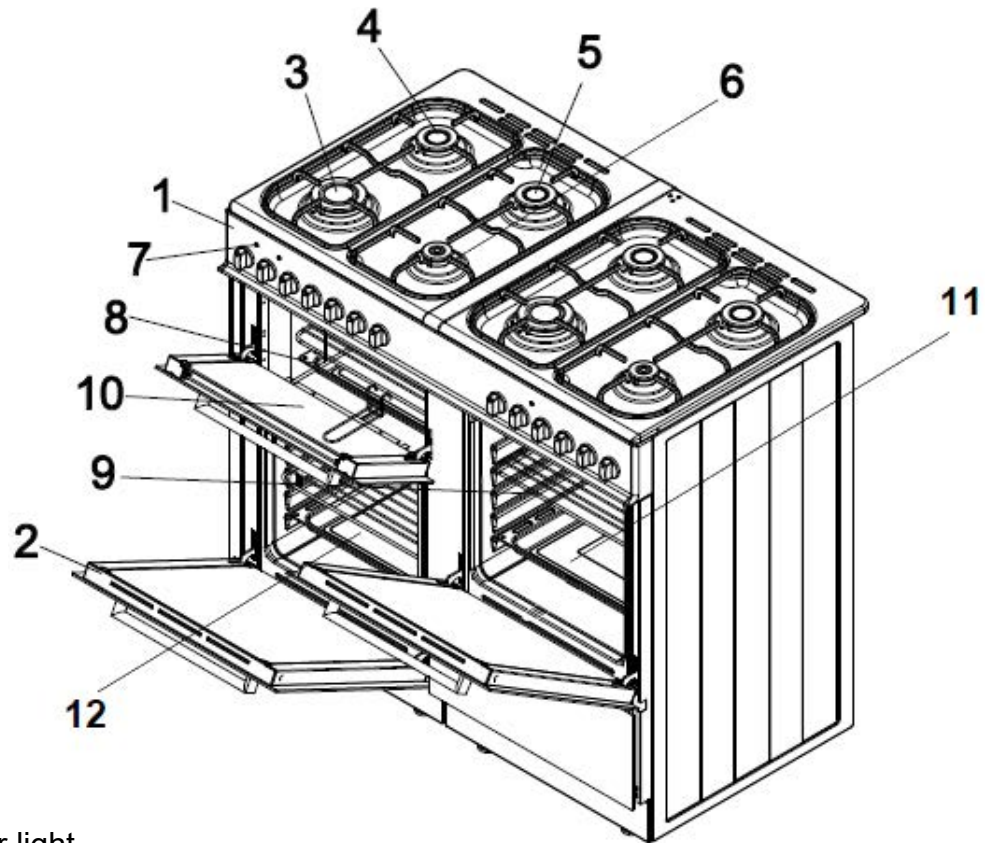

- 1- Control panel
- 2- Oven door
- 3- Big burner
- 4- Middle burner
- 5- Middle burner
- 6- Small burner
- 7- Temperature indicator light
- 8- Grill pan with removable handle
- 9- Wire shelves
- 10- Grill and conventional oven door
- 11- Fan oven
- 12- Second fan oven

Accessories

Grill pan and handle set



6 wire shelves



Positioning of the shelf



or online at www.argos-support.co.uk If you still require further assistance, call one of our experts on 01759 487838

Installing your Dual Fuel Range Cooker

3

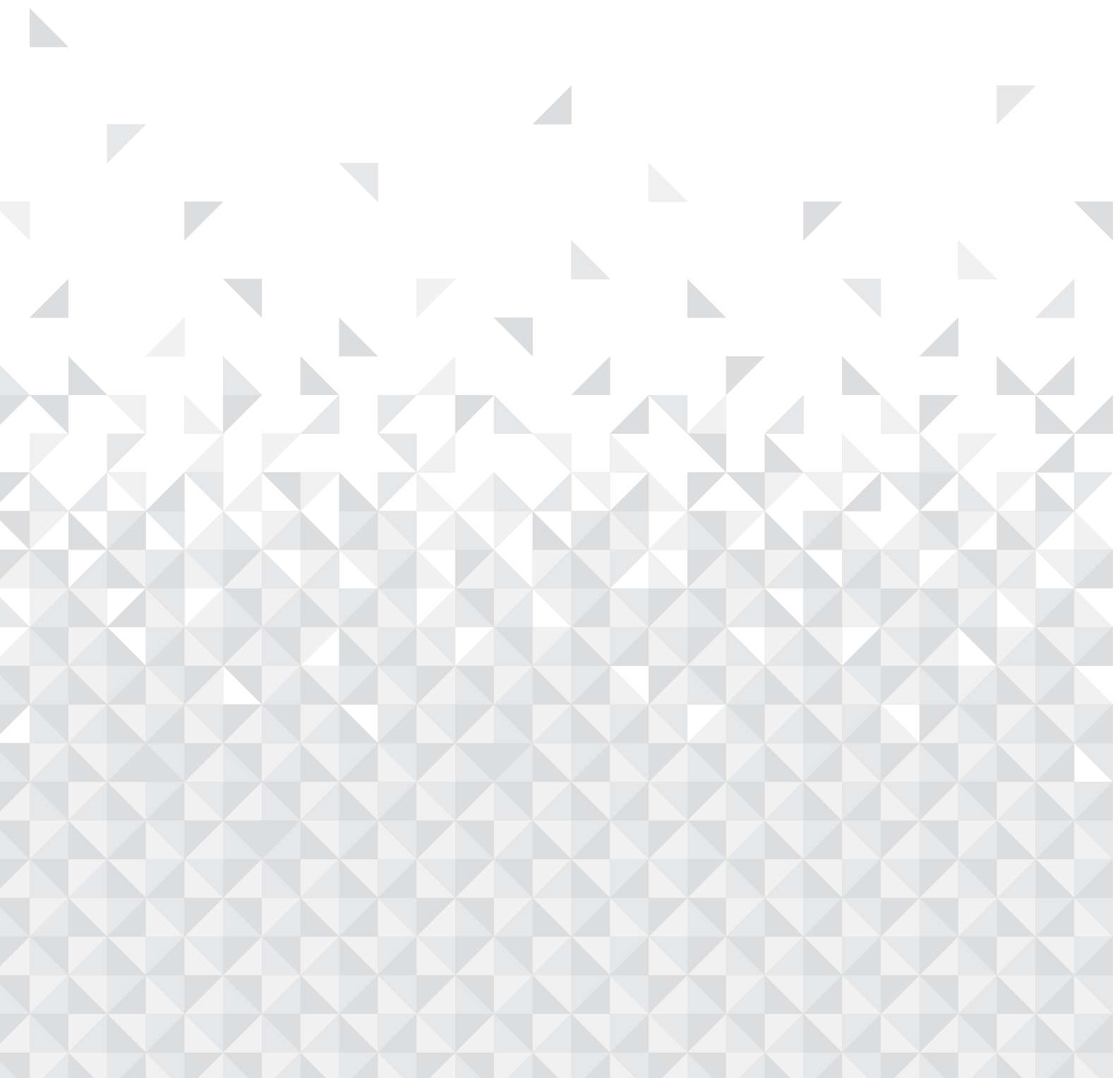

Installing your Dual Fuel Range Cooker

Bringing it all together

Installation requirements

THIS COOKER MUST BE INSTALLED ACCORDING TO BS 6172: 2010 BY A SUITABLY QUALIFIED GAS SAFE REGISTERED INSTALLER

This modern cooker was manufactured with parts and materials of the highest quality and was designed to meet your cooking needs. You should read this manual so that you are able to use the cooker correctly and to avoid any potential problems with using the cooker. The following information outlines the required rules for correct installation and service of your cooker. This is particularly important for the technician who will install the appliance.

Positioning

The furniture close to the cooker must be manufactured resistant to temperatures up to 100°C

If the kitchen furniture are higher than the hob plate of the cooker, it must be at least 10cm away from the cooker's side.

Surrounding furniture, cabinets and extractor fans should be positioned in accordance with the diagram shown in figure 3. If fitted, the extractor fan must be at least 65cm above the hob. If no fan is fitted the minimum distance between the hob and any cabinet or other structure must be 70cm.

First Use

IMPORTANT: When using your oven for the first time your cooker may give off an unusual odour from the heating elements and insulation materials. This is normal for new cookers. To eliminate this odour run the oven at 250 degrees for 40-60 mins with the oven empty.

Unpacking

Carefully unpack and examine the appliance for any damage. If you think there is a defect, do not use the appliance and contact Argos Product Support on 01759 487838.

Packaging materials should be collected together and disposed of immediately as they may be harmful to children.

Levelling feet

The height and level of the appliance can be adjusted by rotating the feet located underneath the appliance at each corner. Rotate in a clockwise direction to decrease the height and anti clockwise to increase the height.

Installing your Dual Fuel Range Cooker

Bringing it all together

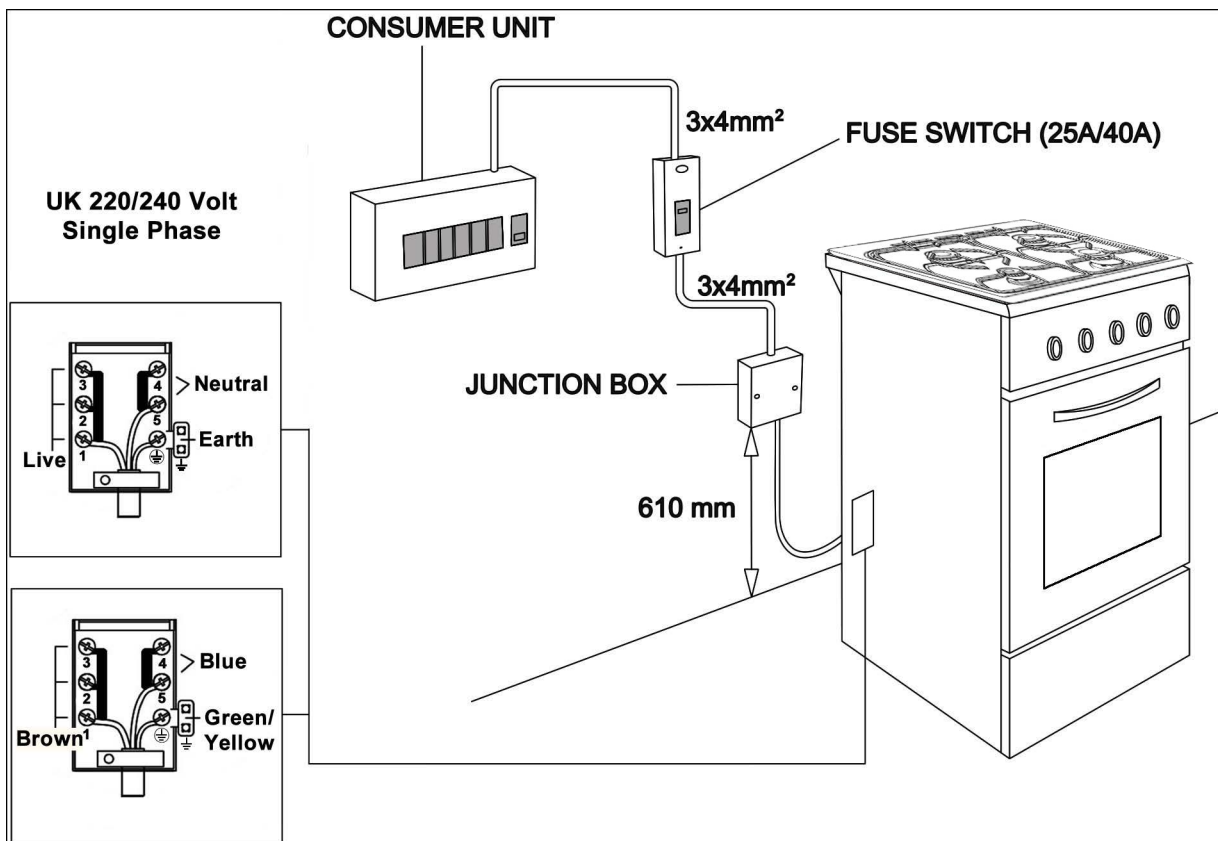

Connections

Gas

Electrical



- **IMPORTANT:** Electrical connections must be carried out by a suitably qualified person and in accordance with all relevant local building and installation regulations.

1. See the rating label at the rear of the product for the appliance's load rating.
2. The cooker must be connected to a dedicated circuit suitably rated for the load of the appliance (see rating label at rear of appliance) as shown in the wiring diagrams below. It must be connected via a suitably rated cable to a double pole isolator cooker switch also suitably rated for the appliance.
3. **The electrical cable should not touch the hot parts of the appliance.**



The electrical cable (not supplied) should not be routed through any area that may be affected by heat from the oven, especially the area directly behind the oven.

This appliance must be installed by a suitably qualified gas safe registered gas installer to standard BS 6172: 2010

! Failure to do this will invalidate your warranty

Fixing to the wall

Before using the appliance fix it securely to the wall using the chains on the back of the cooker. This will prevent the cooker from toppling forward if excess weight is placed on the oven door. Since the chains must be attached to wall fixings suitable for your wall type, the wall fixings are not supplied with the cooker (Figure 4).

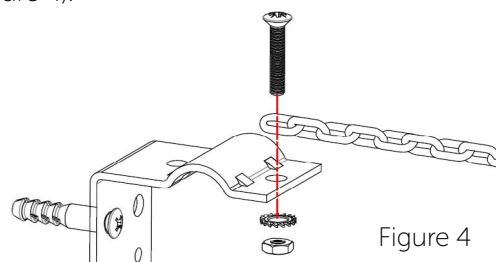
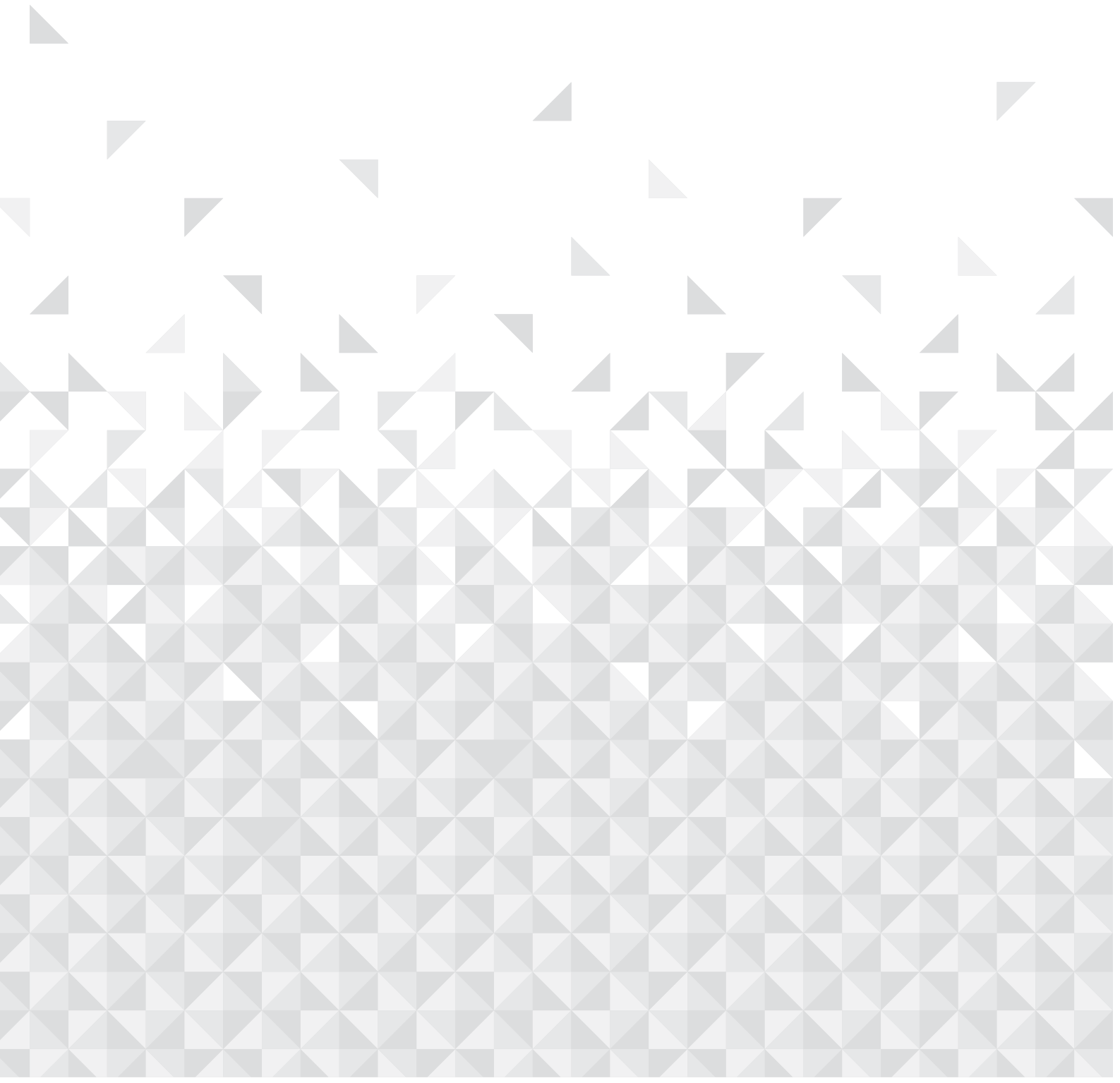

Figure 4

or online at www.argos-support.co.uk If you still require further assistance, call one of our experts on 01759 487838.

Using your Dual Fuel Range Cooker 4



Using your Dual Fuel Range Cooker

Getting the most from your appliance

Using the hobs

Ignition

Press the knob of the burner you want to operate and turn the knob in the counter-clockwise direction so that the knob is in max. position and with your other hand, press the ignition button at the same time. Press the ignition button immediately.

Manual Ignition of the Gas Burners

In the case of electricity failure resulting in loss of electronic ignition follow this procedure.

To ignite one of the burners, press and turn its knob counter-clockwise so that the knob is in max. position, ignite with a match, taper or another manual aid to its upper circumference. Move the ignition source away as soon as you see a stable flame.

Flame failure device:

This cooker is equipped with a flame failure device

In order for these to work correctly and to prevent the flame going out when you first ignite your burners, keep the knob pressed and hold for 10 seconds after the burner has ignited

Hob Burner Control

Left front burner Left rear burner



Large flame Small flame

Control of the hob burners

The knob has 3 positions: Off (0), max (big flame symbol) and min (small flame symbol). After you ignite the burner in max. position you can adjust the flame length between max. and min. positions.

Do not operate the burners when the knob position is between max. and off positions. After the ignition, check the flames visually. If you see yellow tips, lifted or unstable flames; turn the gas flow off, and check the assembly of burner caps and crowns. Also, make sure that no liquid has spilled into the burner caps.

If the burner flames go out accidentally, turn the burners off, ventilate the kitchen with fresh air, and do not attempt re-ignition for 90 sec.

When turning the hob off, turn the knob in the clockwise direction so that the knob shows "0" position or the marker on the knob points upwards.

Using your Dual Fuel Range Cooker

Getting the most from your appliance

Your hob has burners of different diameters. The most economic way of using gas is to choose the correct size gas burners for your cooking pan size and to bring the flame to the minimum position once the boiling point is reached. It is recommended to always cover your cooking pan.

Cookware Selection

In order to obtain maximum performance from the main burners, use pots with the following flat bottom diameters. Using smaller pots than the minimum dimensions stated below will cause energy loss.

Rapid Burner: 22-26cm

Medium Burner: 14-22cm

Auxiliary Burner: 12-18cm

Make sure that the tips of the flames do not spread out of the outer circumference of the pan, as this may also harm the accessories around the pan (handles etc.)

When the burners are not in use for prolonged periods, always turn the main gas control valve off.

WARNING:

Use only flat bottomed pans and with a sufficiently thick base.

Ensure that the base of the pan is dry before placing it on the burners.

The temperature of accessible parts may be high when the appliance is operating. So it is important to keep children and animals out of the reach of the burners during and after cooking (until the cooker has cooled down).

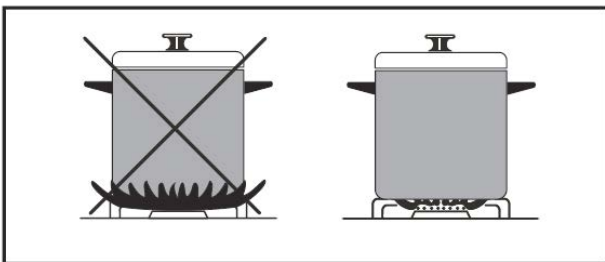

After use the hob remains very hot for a prolonged period of time, do not touch it and do not place any object on top of the hob. Never place cutlery or lids on the hob as they will get hot and could cause serious burns.

SAFETY ADVICE IN THE CASE OF A COOKING PAN FIRE

1. Turn off the burner.
2. Cover the pan with a fire blanket or damp cloth. This will smother the flames and extinguish the fire.
3. Leave the pan to cool for at least an hour before attempting to move it. Injuries are often caused by picking up a hot pan and rushing outside with it.

NEVER USE A FIRE EXTINGUISHER TO PUT OUT A PAN FIRE

as the force of the extinguisher could tip the pan over.

Never use water to extinguish oil or fat pan fires.

Using the Fan Ovens

Turn the Main Oven knob clockwise and align the marker on the control knob with the required temperature (°C)

The indicator light on the control panel will go out and the thermostat will turn the element off when the selected temperature has been reached inside the oven. These will come back on once the thermostat falls below the set value.

Fan only defrost

The fan can be used without heat to defrost food (DEFROST)

IMPORTANT! Before using this method of defrosting refer to the food packaging defrosting information

Always turn the control knob to **off** (●) when cooking has finished.

Please note: The appliance incorporates a safety thermostat which cuts the electric supply to the oven if the temperature becomes excessive.

When using your oven for the first time your cooker may give off an unusual odour from the heating elements. This is normal for new cookers. To eliminate this odour run the oven at 250 degrees for 40-60 mins with the oven empty.

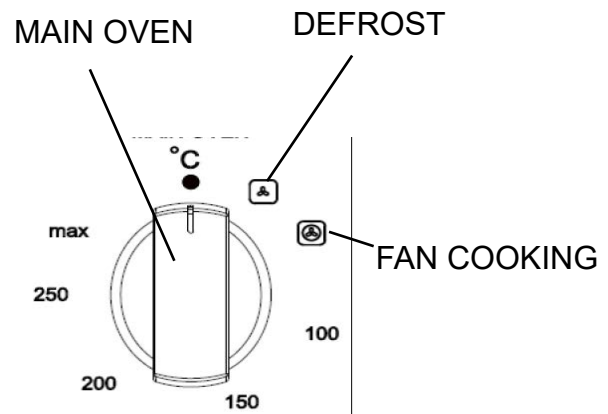

Using the Timer

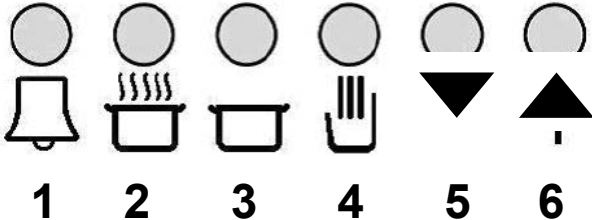

- | | |
|-------------------|--------------------------------|
| Buttons | The electronic timer functions |
| 1. Alarm | 1. Clock with alarm |
| 2. Start cooking | 2. Set cooking time |
| 3. Stop cooking | 3. Set food ready time |
| 4. Manual control | 4. Timer |
| 5. Down | 5. Buzzer volume control |
| 6. Up | 6. LED brightness control |

Display icons

- Auto program has been set.
- Auto program now cooking.
- Auto program food is now ready.
- Note, Alarm is now sounding

Setting the time

To set the time, ensure that no automatic cooking program is in progress (there should be just the time and the manual control icon displayed as shown in the image above).

Press the manual control button (4) the double point icon between the hours and minutes will start to flash. Use the up and down buttons to set the clock. Press and hold the up and down buttons for faster adjustment.



- 1) Switch into time adjustment mode.
- 2) Adjust the time using the ∇ or \blacktriangle buttons.
- 3) Screen will be stabilized in 5 seconds.

Setting the timer (alarm)

With this feature you can set the alarm to sound after lapsed period of time.

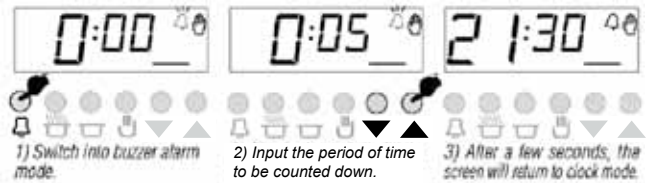

- 1) Switch into buzzer alarm mode.
- 2) Input the period of time to be counted down.
- 3) After a few seconds, the screen will return to clock mode.

Cancelling the timer (alarm)

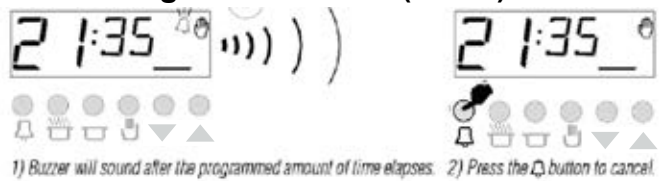

- 1) Buzzer will sound after the programmed amount of time elapses.
- 2) Press the \square button to cancel.

Automatic oven cooking control

If you want to start cooking in your oven immediately, you just need to input the length of cooking time.

Example: We placed our food into the oven and want it to be cooked for 2 hours and 15 minutes



- 1) Current time is 18:30.
- 2) Switch into cooking time mode.
- 3) Adjust the cooking time using the ∇ or \blacktriangle buttons.

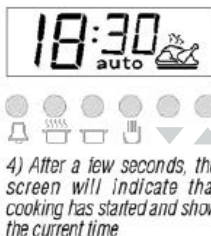

You have now set your oven to cook for 2 hours and 15 minutes. Please do not forget to turn the oven knob to the required temperature

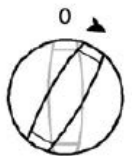

- 4) After a few seconds, the screen will indicate that cooking has started and show the current time

Note: You may cancel the automatic cooking mode any time by pressing the \square button.

At any time during cooking you can press the stop cooking button (3) to see the time that the food will be ready.

Delayed cooking program

Once you have set the length of cooking time, you can use this feature to have your food ready at a set given time.

For example,

To have your food ready at 21:30 press the stop button (3) then set the desired ready time. After a few seconds the display will switch to clock mode.

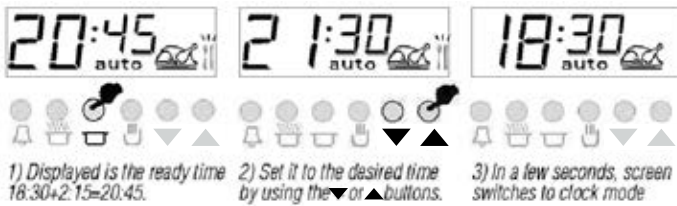

We have now programmed our oven to have our food ready at 21:30. The cooking time was pre-programmed as 2 hours and 15 minutes so your oven will start cooking at 19:15 and ensure that your food is ready at 21:30.

As advised before do not forget to set the oven temperature control to the desired temperature.

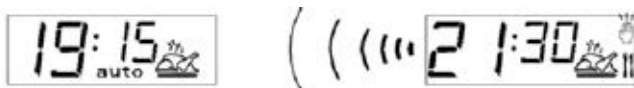

When automatic cooking is completed, a buzzer alarm is heard and will sound, if not stopped, for 7 minutes.

Resetting after loss of mains power

If the cooker has been turned off or had a power interruption the screen will flash and 12:00 will be displayed. Any cooking program will have been cancelled. The flashing hand icon indicates that your oven is inoperative.

Press the manual control button once to get your oven operational. Press the manual button once again to set the clock (see setting the time section).

Alarm volume

Press and hold the ▼ key to hear the current alarm tone. Releasing and pressing the same button will allow you to scroll through the 3 available tones.

Note, the default setting is the highest tone level of the three.

LED brightness

By pressing and releasing the ▲ key, you can scroll through the three available brightness settings.

Note, the default setting is the highest brightness level of the three.

Using the Conventional Oven and Grill

Turn the control knob (TOP OVEN) clockwise and align the marker on the knob with the required temperature.

The indicator light on the control panel will go out when the selected temperature has been reached inside the oven.

Always turn the control knob to off (●) when cooking has finished.

Please note: The appliance incorporates a safety thermostat which cuts the electric supply to the oven if the temperature becomes excessive.

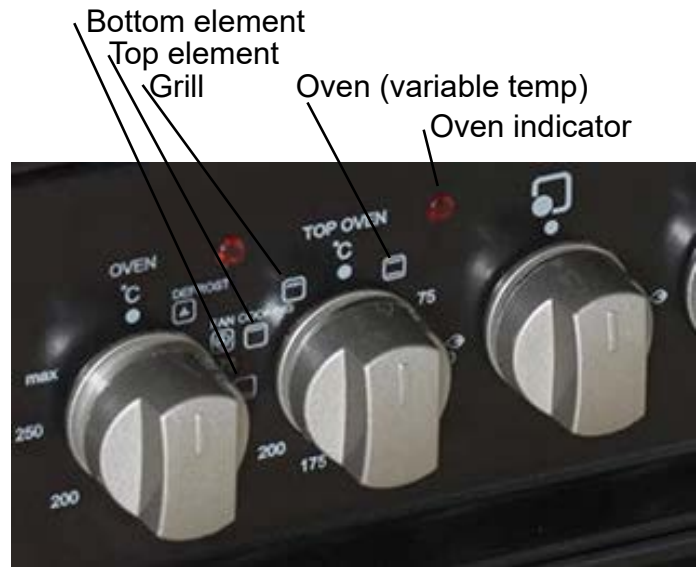

For using the

- Bottom element
- Top element
- Grill

Turn the control knob clockwise and align the marker with the desired function.

These elements are set to operate at their maximum output (fixed).

WARNING! THE TOP OVEN/GRILL DOOR MUST BE CLOSED WHEN USING THE OVEN OR GRILL.

Always use the handle when handling the grill pan.

Storage compartment

This range cooker incorporates a storage compartment.

This compartment is for pans, oven trays and other non flammable cooking equipment.

Do not store anything flammable in this compartment.

Please note this compartment may get hot.



Storage Compartment

Care and maintenance 5

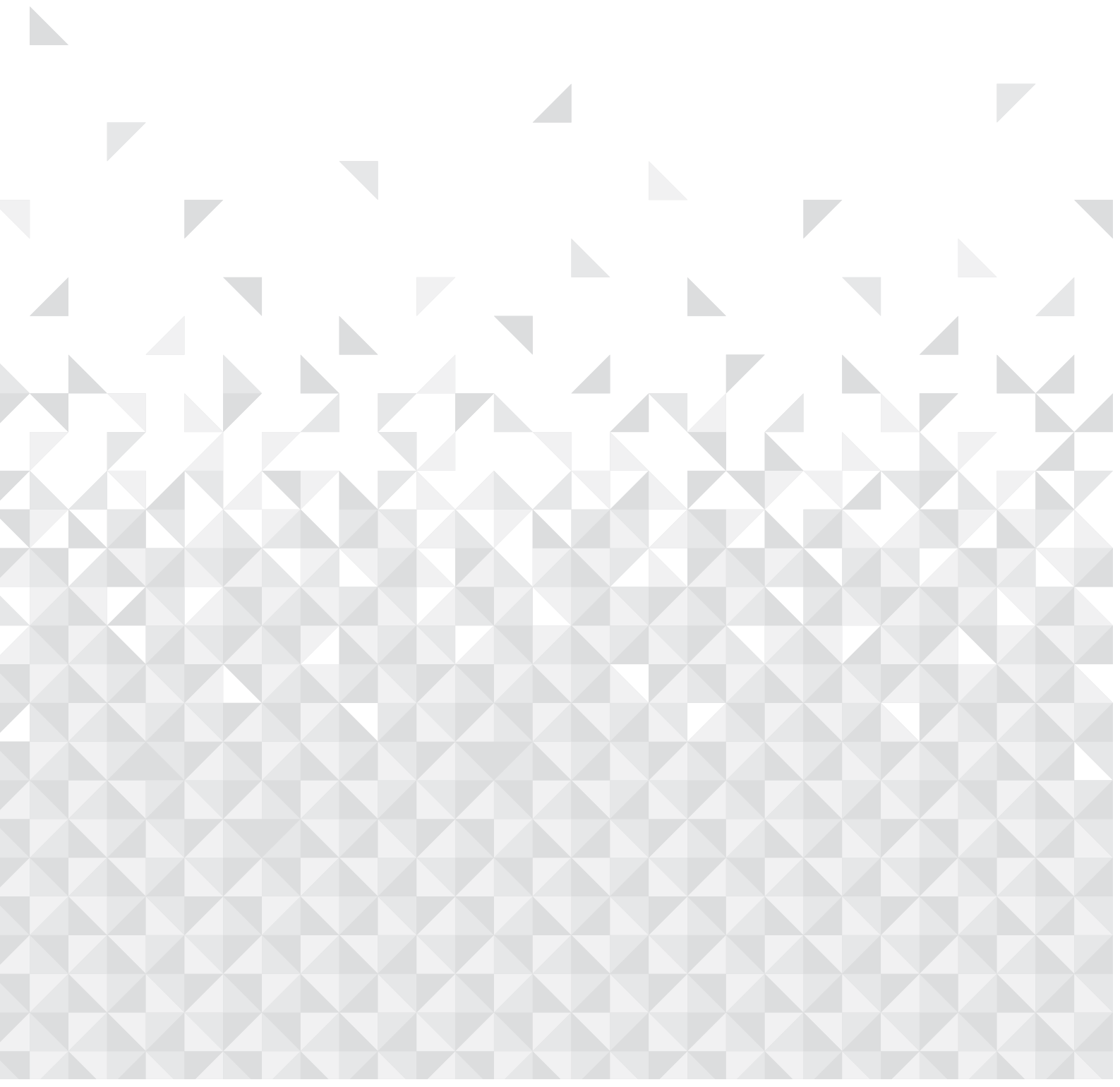

Care and maintenance

Looking after your appliance

Cleaning

WARNING! Isolate the power supply to the cooker and make sure that the oven is cool.

Do not clean using caustic creams, abrasive cleaning powders, thick wire wool or hard tools. Enamelled parts of the oven can be damaged if excess cleaning liquids are not immediately removed.

After cleaning the interior parts of the oven with a soapy cloth, rinse it and then dry thoroughly with a soft cloth.

Clean the glass surfaces with special glass cleaning agents.

Never use flammable agents like acid, thinner or petrol when cleaning your oven.

Do not clean your oven with a steam cleaner.

Do not wash any part of your oven in a dishwasher.

Burner Caps:

Periodically, the enamelled pan support, enamelled covers and burner heads must be washed with warm soapy water, rinsed and dried. After drying them thoroughly, place them back in their original positions on the burners

Enamelled Parts:

In order to keep enamelled parts as new, it is necessary to clean them frequently with mild warm soapy water and then dry with a cloth. Do not wash them while hot and never use abrasive powders or abrasive cleaning materials. Do not leave anything spilled onto enamelled parts for long periods of time.

Stainless Steel:

Stainless steel parts must be cleaned frequently with mildly warm soapy water and a soft sponge and then dried with a soft cloth. Do not use abrasive powders or abrasive cleaning materials. Do not leave anything spilled onto stainless steel parts for long periods of time.

Care and maintenance

Looking after your appliance

Technical specification

Models	BFCX100DFC BFCX100DFSS BFCX100DFB
Power supply	220-240V~50 Hz
Maximum power	5600W
Size (H x W x D)	900 x 1003 x 600
Net Weight	90 kg (approx)
Grill/Oven compartment volume	25 lt
Fan oven volume (upper right)	49 lt
Lower left oven	54 lt
Energy rating	A

We apologise for any inconvenience caused by minor inconsistencies within these instructions that may occur due to product improvements and development

All images and drawings are for illustration purposes only.

Product support

6

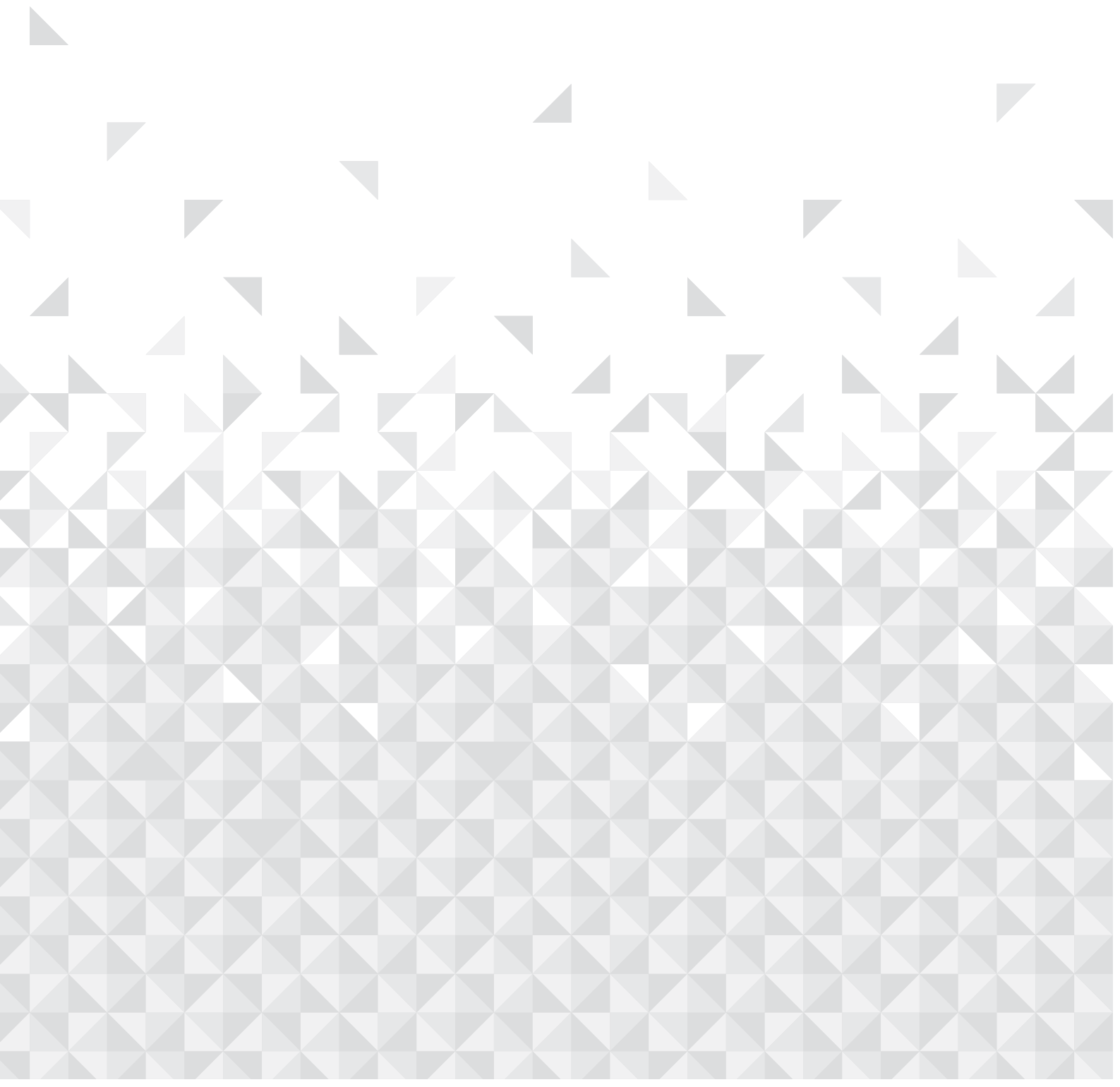

Product support

Help is always at hand

Troubleshooting

1. If no electrical functions appear to work, check the cooker isolation switch has not been turned off also check the fuse in the switch and the circuit breaker in your consumer unit

2. After replacing the fuse or resetting the circuit breaker turn on individual parts of your cooker one at a time to check function

3. **DO NOT** attempt to repair this cooker yourself. Call Argos Product Support or consult a qualified person

Problem	Possible Cause	Solution
Only parts of the cooker work it may be that the ovens or the grill, do not work	Links may be missing in the rear connector box	Refer to the Quick Start Guide to check the correct placement of the links This must be done by a qualified competent person
Nothing works (completely dead)	Power is turned off at the isolation switch or the consumer unit Poor electrical connection	Ensure isolation switch is on Check consumer unit has not tripped out Have the connections checked by a qualified electrician
The hob burners do not operate correctly	Check if the burner parts are correctly assembled (especially after cleaning).	The gas supply pressure may be too low/high. For appliances working with bottled LPG, the LPG cylinder may be depleted.
Oven not heating up	Oven temperature not set correctly Door is not properly closed	Ensure that the correct temperature has been selected and the door is properly closed

If you require any technical guidance or find that your product is not operating as intended, a simple solution can often be found in the **Troubleshooting** section of these instructions.

Product support

Help is always at hand

Help and assistance

If you require any technical guidance or find that your Dual Fuel Range Cooker is not operating as intended, a simple solution can often be found in the **Troubleshooting** section of these instructions or online at www.argos-support.co.uk

If you still require further assistance, call one of our experts on **01759 487838***. To help give us give you a fast and efficient service please have the following information ready:

Model Ref.

You can find these on the rating plate - a small information panel (usually a sticker or metal plate) on the rear of your appliance

Serial number

Date of purchase

This will be shown on your receipt

Local call rates applies*

Lines open 8am-7pm Monday to Saturday and 10am-4pm Sunday.

*Calls to Argos enquiry lines may attract a charge and set up fee from residential lines depending on your call plan/tariff. Mobile and other providers costs may vary, see www.bt.com/pricing for details.

For Security and training purposes, telephone calls to and from customer service centres maybe recorded and monitored. Calls from Republic of Ireland will attract international call charges.

or online at www.argos-support.co.uk If you still require further assistance, call one of our experts on **01759 487838**

Declaration of conformance to product standards

This appliance conforms to all relevant standards applicable to domestic appliances sold in the UK

Disposal



This appliance/fitting is marked according to the European directive 2002/96/EC on Waste Electrical and Electronic Equipment (WEEE).

By ensuring this product is disposed of correctly, you will help prevent potential negative consequences for the environment and human health, which could otherwise be caused by inappropriate waste handling of this product.

The symbol on the product, or on the documents accompanying the product, the **crossed out wheellie bin** symbol, indicates that this appliance/fitting may not be treated as household waste. Instead it shall be handed over to the applicable collection point for the recycling of electrical and electronic equipment.

Disposal must be carried out in accordance with local environmental regulations for waste disposal.

For more detailed information about treatment, recovery and recycling of this product, please contact your local authority, your household waste disposal service or the retailer where you purchased the product.

Product support

Help is always at hand

BUSH

Call us now and activate your 12 month guarantee

Thank you for choosing Bush. Your new product is guaranteed against faults and breakdowns for 12 months. Don't forget to register it with us today so we can provide you with our best possible after-sales service and useful updates.

www.bushregistration.co.uk

FREEPHONE*

0800 597 8548

Lines are open 8am - 8pm, 365 days a year. *Calls may be recorded and monitored.

Your Bush Guarantee

This product is guaranteed for twelve months from the date of original purchase. Any defect that arises due to faulty materials or workmanship will be repaired free of charge (or if applicable the product will be replaced or the purchase price refunded) where possible during this period by the dealer from who your purchased the unit.

The guarantee is subject to the following provisions:

- The guarantee does not cover accidental damage, misuse, cabinet parts, knobs or consumable items.
- The product must be correctly installed and operated in accordance with the instructions contained in the manual.
- It must be used solely for domestic purposes. The guarantee will be rendered invalid if the product is re-sold or has been damaged by inexpert repair.
- Specifications are subject to change without notice.
- Bush disclaim any liability for loss or damage arising from the breakdown of the product.
- This guarantee is in addition to and does not diminish your statutory or legal rights.

Important Data Protection Information

If you provide us with information about another person, you confirm that they have appointed you to act for them, to consent to the processing of their personal data including sensitive personal data and that you have informed them of our identity and the purposes (as set out in the Important Data Privacy notice displayed overleaf) for which their personal data will be processed.

You are entitled to ask for a copy of the information we hold about you (for which we may charge a small fee) and to have any inaccuracies in your information corrected.

For quality control and training purposes, we may monitor or record your communications with us.

If your personal details change, if you change your mind about any of your marketing preferences or if you have any queries about how we use your information, please let us know by contacting our Data Protection Officer, Domestic & General, Leicester House 17 Leicester Street, Bedworth, Warwickshire CV12 8JP.

Guarantor: Argos Limited - 489 - 499 Avebury Blvd. - Milton Keynes - MK9 2NW

or online at www.argos-support.co.uk If you still require further assistance, call one of our experts on **01759 487838**

Product support

BUSH

BUSH



Contact:

www.argos-support.co.uk

Helpline: 01759 487838