

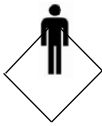

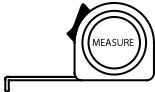

IMPORTANT, RETAIN FOR FUTURE REFERENCE AND READ CAREFULLY. ASSEMBLY AND CARE INSTRUCTIONS FOR ODYSSEY CIRCULAR SIDE TABLE

| <u>DESCRIPTION</u> | | |
|--|---|--|
| ITEM NAME: ..ODYSSEY CIRCULAR SIDE TABLE.. | | ITEM NO:.....37171..... |
| <h1>20 Minutes</h1> |  1 PERSONS ASSEMBLY | Floor Area 1.0M x 1.0M  Ceiling Heights 2.0M REQUIRED ASSEMBLY SPACE |
| APPROXIMATE ASSEMBLY TIME | | REQUIRED ASSEMBLY SPACE |
| REQUIRED ASSEMBLY TOOLS | |   |
| ASSEMBLED DIMENSIONS | | |
|  <p>The diagram shows a circular side table with a diameter of 450mm and a height of 450mm. It has a round top and a matching round base, supported by four legs. The top surface has several small circles and diagonal hatching lines. The base also has diagonal hatching lines and a small detail at the bottom edge.</p> | | |
|  | | MOUNTROSE LIMITED, ALAN HOUSE, ASHTON ROAD, BREDBURY, STOCKPORT. SK6 2QN UNITED KINGDOM |

DESCRIPTION

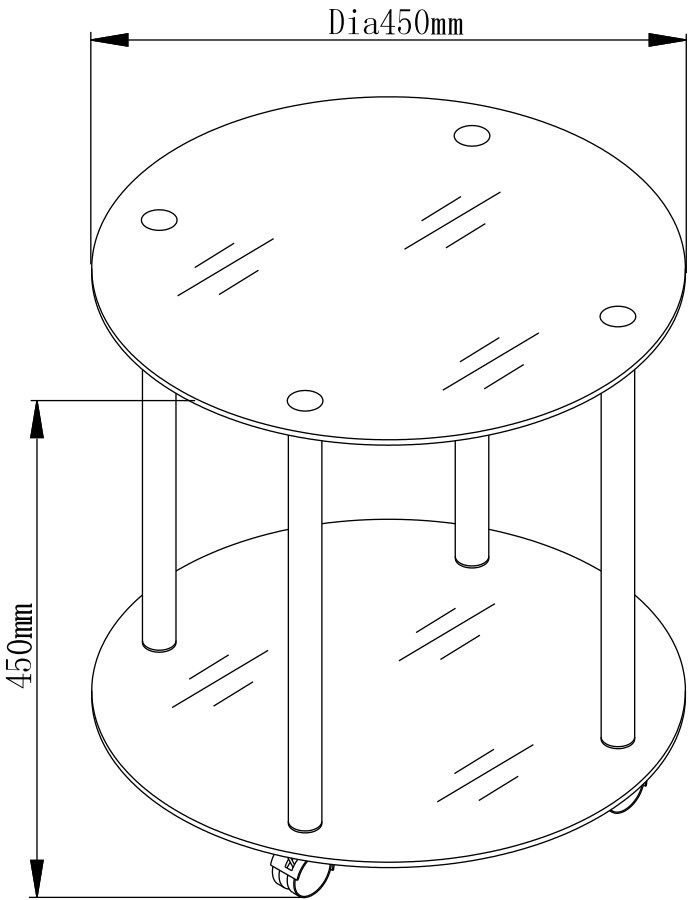
ITEM NAME: ODYSSEY CIRCULAR SIDE TABLE.

ITEM NO: 37171

| Maximum load | |
|--------------|------|
| Top shelf | 30KG |
| Undershelves | 20KG |

PARTS LIST

| NO. | PART LIST | QTY |
|-----|-------------------------------------|-----|
| (1) | TOP SHELF | 1 |
| (2) | METAL POLE | 4 |
| (3) | BOTTOM SHELF | 1 |
| (4) | φ50x5/16" WHEEL WITH STOPPER(FRONT) | 2 |
| (5) | φ50x5/16" WHEEL(BACK) | 2 |
| (6) | METAL RODS | 4 |
| (7) | CLEAR PLASTIC WASHER | 4 |
| (8) | PLASTIC INSERTS (PACKED WITH POLE) | 4 |

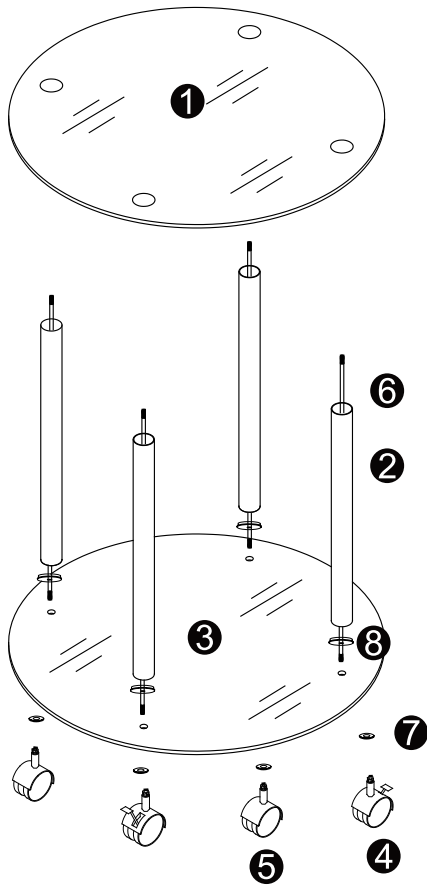

DESCRIPTION

ITEM NAME: ODYSSEY CIRCULAR SIDE TABLE.

ITEM NO: 37171

Top Tips before you start!

1. Please check that all parts are present before you start the assembly of your furniture, as once assembled, the furniture is exempt from our home approval policy.
2. For ease and speed of assembly, we recommend that before you commence each step of the assembly, that you identify all the parts required for that step.
3. For larger items, please ensure that you have sufficient space and people (it should be as indicated on page 1) to assemble your product safely.
4. We recommend that, where possible, all items are assembled near to the area in which they will be placed in use, to avoid moving the product unnecessarily once assembled.
5. For the protection of your furniture, particularly items of high gloss finish, we recommend that the product is placed on a protected surface during assembly to prevent any damage.
6. During assembly please take care not to over-tighten any fittings, as this may damage the product.

Care and Maintenance of your Furniture

- The class of glass used it complies with Class A OF BS 6206.
- This Product complies with BS EN 12521:2009, imported by Mountrose Ltd Stockport SK6 2QN (EMAIL qc@mountrose.co.uk <mailto: qc@mountrose.co.uk>) 5MM Thickness Tempered Glass. Model No.Z G-SGH-0020- Batch Number 7864 Dia450 x 5MM if a glass component is chipped or broken, replace with glass of the type described on this label.
- Consult the manufacturer, retailer or agent with regard to obtaining a manufacturing specification and shape for replacement, glass quoting the model number and batch number or date of manufacture.
- Please periodically check all fittings and re-tighten as necessary.
- Please do not sit or stand on this item.
- Please do not drag and pull your furniture.
If the glass is chipped or broken, stop using the product and consult the manufacturer or supplier.
- Please do not place very hot or very cold items on the glass surface, unless adequately thick table mats are used to prevent such items from coming into contact with the glass.
- Please do not use the glass as a chopping surface. Do not strike the glass with hard or pointed items.
- When cleaning glass panels use a damp cloth or leather with washing up liquid or soft soap if necessary, do not use washing powders or any other substances containing abrasives since these substances scratch glass.

DESCRIPTION

ITEM NAME: ODYSSEY CIRCULAR SIDE TABLE.

ITEM NO: 37171

STEP 1

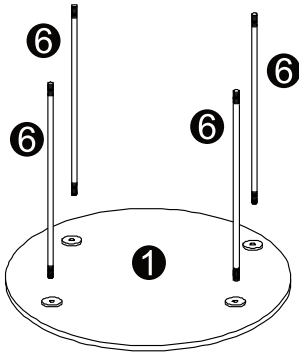

STEP 2

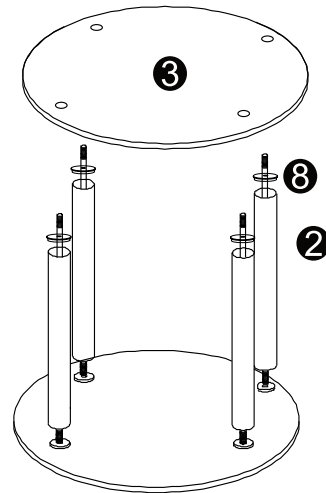

STEP 3

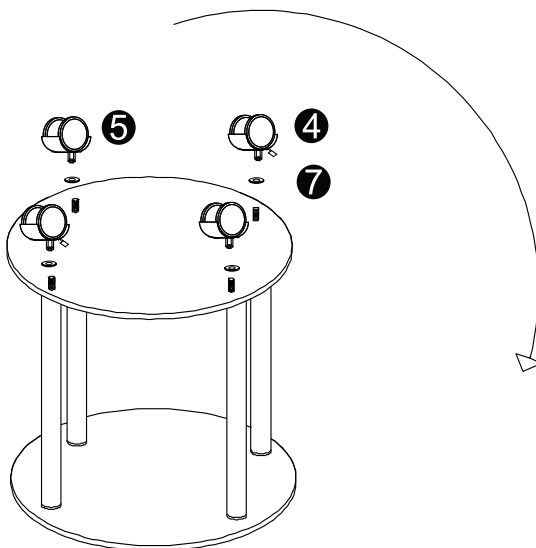

STEP 4

