

IMPORTANT, RETAIN FOR FUTURE REFERENCE AND  
 READ CAREFULLY. ASSEMBLY AND OPERATING  
 INSTRUCTIONS FOR HALL TABLE

**DESCRIPTION**

ITEM NAME: EVELYN HALL TABLE  
 ITEM NO: 41019

**15 mins**

APPROXIMATE ASSEMBLY TIME



1 PERSON ASSEMBLY

Floor Area  
 1.5 m x 1.5 m

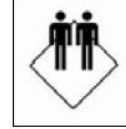

Ceiling Heights  
 2.0 m

REQUIRED ASSEMBLY SPACE

REQUIRED ASSEMBLY TOOLS



Allen key

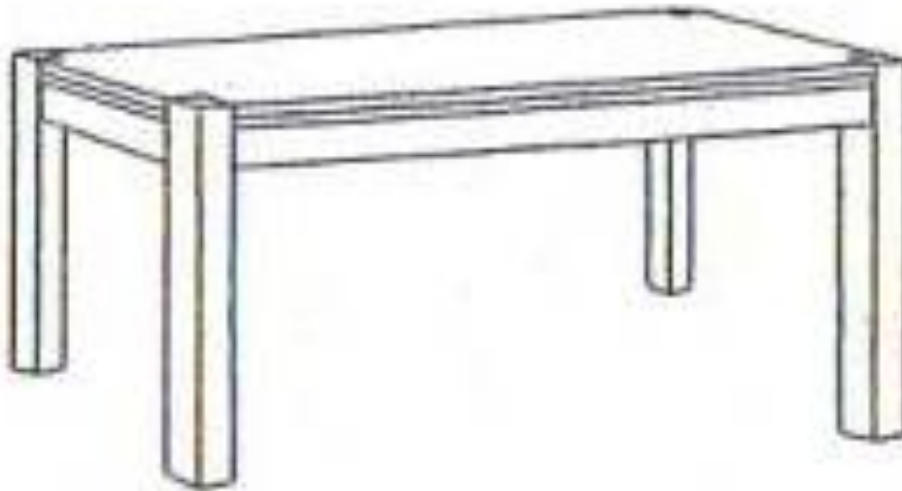





***ASSEMBLED HALL TABLE***

## DESCRIPTION

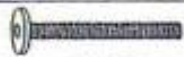
ITEM NAME: EVELYN HALL TABLE

ITEM NO: 41019

HARDWARE PACK		
NO.	DESCRIPTION	QTY.
A	 JCB SCREW ( M8 x 60 mm )	8 PCS
B	 FLAT WASHER ( M8.5 x 18 mm )	8 PCS
C	 SPRING WASHER ( 5 / 16" x 15 mm )	8 PCS
D	 ALLEN KEY ( M5 )	1 PC

### Top Tips before you start!

- 1 .Please check that all parts are present before you start the assembly of your furniture, as once assembled the furniture is exempt from our home approval.
2. For ease and speed of assembly, we recommend that before you commence each step of the assembly, that you identify all the parts required.
3. For larger items, please ensure that you have sufficient space and people (as indicated on page 1) to assemble our product safely.
4. We recommend that, where possible, all items are assembled near to the area in which they will be placed in use, to avoid unnecessary moving of the product.
5. For the protection of your furniture, we recommend that the product is placed on a protected surface during assembly to prevent any damage.
6. During assembly please take care not to over-tighten any fittings, as this may damage the product .

### General for Table

- Please periodically check all fittings and re-tighten as necessary.
- Please do not sit or stand on this item.
- Please do not drag and pull your furniture.
- To clean your items, please use a soft cloth moistened in luke warm soapy and water. Then buff with a dry clean cloth.

## DESCRIPTION

ITEM NAME: EVELYN HALL TABLE

ITEM NO: 41019

\* NOTE :  
PLEASE ASSEMBLY ON SMOOTH SURFACE.

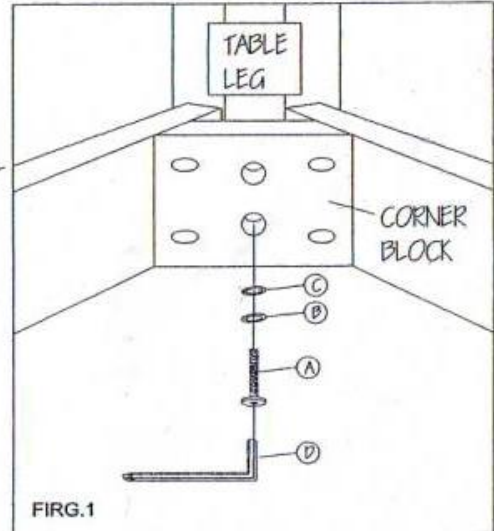
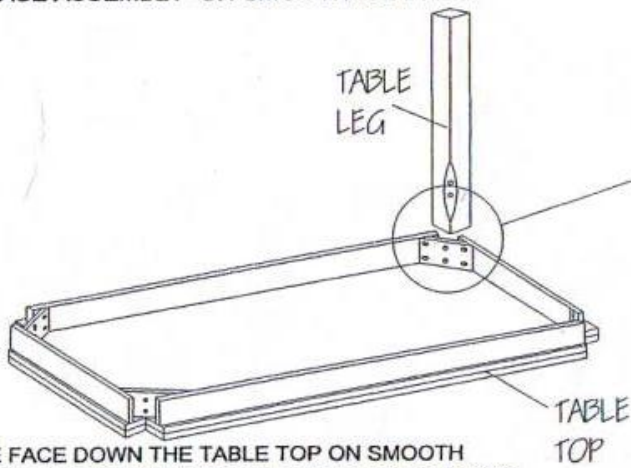

- 1). PLEASE FACE DOWN THE TABLE TOP ON SMOOTH SURFACE, ATTACH THE TABLE LEG AT CORNER BLOCK AS SHOWN IN (FIG.1), USE HARDWARE (A),(B),(C) AND TIGHT IT BY (D) , FOLLOW DO IT FOR EACH TABLE LEG AND TIGHTEN IT.

" NOTE :  
PLEASE DO NOT USE ELECTRIC DRILL FOR FIXING "

# MOUNTROSE

Thank you for purchasing your new Mountrose product.  
If in the unlikely event you experience any problems with assembly, or require any spare screws/fixings for this product.

**DO NOT RETURN THIS ITEM!!!!**

Please Telephone the Mountrose Customer Helpline

**0161 406 5040**

or email [qc@mountrose.co.uk](mailto:qc@mountrose.co.uk)

THIS DOES NOT AFFECT YOUR STATUTORY RIGHTS