

Gtech
AirRam 

Model number: AR30

OPERATING MANUAL

IMPORTANT SAFEGUARDS:



IMPORTANT: READ ALL INSTRUCTIONS BEFORE USE. RETAIN INSTRUCTIONS FOR FUTURE REFERENCE.



Do not use in rain or leave outdoors whilst raining.



WARNING: Basic safety precautions should always be observed when using an electrical appliance, including the following to reduce the risk of fire, electrical shock, or injury:

Personal Safety:

- Store indoors in a dry place out of the reach of children.
- Always use responsibly. This appliance can be used by children aged from 8 years and above and persons with reduced physical, sensory or mental capabilities or lack of experience and knowledge if they have been given supervision or instruction concerning use of the appliance in a safe way and understand the hazards involved.
- Don't let children play with the appliance; supervise children using or maintaining the appliance.
- Use only manufacturer's recommended attachments as described in this manual; misuse or use of any accessory or attachment other than those recommended, may present a risk of personal injury.
- Take extra care when cleaning stairs.
- Keep the appliance and accessories away from hot surfaces.
- Do not block the appliances openings or hinder air flow; keep openings free of any objects including dust, lint, clothing, fingers (and all parts of the body).
- Particularly keep hair away from openings and moving parts.

Electrical safety:

- Only use batteries and chargers supplied by Gtech.
- Never modify the charger in any way.
- The charger has been designed for a specific voltage. Always check that the mains voltage is the same as that

stated on the rating plate.

A charger that is suitable for one type of battery pack may create a risk of fire when used with another battery pack; never use the charger with another appliance or attempt to charge this product with another charger.

- Before use, check the charger cord for signs of damage or ageing. A damaged or entangled charger cord increases the risk of fire and electric shock.
- Do not abuse the charger cord.
- Never carry the charger by the cord.
- Do not pull the cord to disconnect from a socket; grasp the plug and pull to disconnect.
- Don't wrap the cord around the charger when storing.
- Keep the charger cord away from hot surfaces and sharp edges.
- The supply cord cannot be replaced. If the cord is damaged the charger should be discarded and replaced.
- Do not handle the charger or the appliance with wet hands.
- Do not store or charge the appliance outdoors.
- The charger must be removed from the socket before removing the battery, cleaning or maintaining the appliance.

Battery safety:

- This appliance includes Li-Ion batteries; **do not incinerate batteries or expose to high temperatures**, as they may explode.
- Liquid ejected from the battery may cause irritation or burns.

- In an emergency situation contact professional help immediately!
- Leaks from the battery cells can occur under extreme conditions. Do not touch any liquid that leaks from the battery. If the liquid gets on the skin wash immediately with soap and water. If the liquid gets into the eyes, flush them immediately with clean water for a minimum of 10 minutes and seek medical attention. Wear gloves to handle the battery and dispose of immediately in accordance with local regulations.
- Shorting the battery terminals may cause burns or fire.
- When the battery pack is not in use, keep it away from paper clips, coins, keys, nails, screws or other small metal objects that could make a connection from one terminal to another.
- When you dispose of the appliance remove the battery and dispose of the battery safely in accordance with local regulations.
- Do not pick up liquids or use on wet surfaces.
- Do not pick up anything that is flammable, burning or smoking.
- Use only as described in this manual.
- Don't use on concrete, tarmacadam or other rough surfaces.
- The brush bar may damage certain floor surfaces. Before vacuuming flooring, rugs or carpets, check the flooring manufacturer's recommended cleaning instructions.
- May damage delicate fabrics or upholstery. Care should be taken on loose-weave carpets and coverings or where there are loose threads. If in doubt please test on an inconspicuous area first.
- The Gtech AirRam K9 has been designed to clean a wide variety of floor surfaces without the need to change settings. However some surfaces such as delicate loose-pile rugs or carpets, tasselled rug edges or damaged carpets with exposed threads are not suitable for cleaning with a rotary brush.

Service:

- Before using the appliance and after any impact, check for signs of wear or damage and repair as necessary.
- Do not use the appliance if any part is damaged or defective.
- Repairs should be carried out by a service agent or a suitably qualified person in accordance with relevant safety regulations. Repairs by unqualified persons could be dangerous.
- Never modify the appliance in any way as this may increase the risk of personal injury.
- Only use replacement parts or accessories provided or recommended by Gtech.

Intended use:

- This appliance has been designed for domestic dry vacuum cleaning only.

WARNING:

- **Do not use water, solvents, or polishes to clean the outside of the appliance; wipe clean with a dry cloth.**
- **Never immerse the unit in water and do not clean in a dish washer.**
- **Never use the appliance without the filter fitted.**

Thank you for choosing a Gtech AirRam K9

"I started Gtech to create sensible, easy to use products, which do a great job. Your opinion is important to us. Please take the time to write a review of the AirRam K9 at Trustpilot.co.uk. We will use your feedback to improve our products and services and let other people know what it's like to be part of the Gtech family."

Nick Grey – Inventor, Owner of Gtech

What's in the box

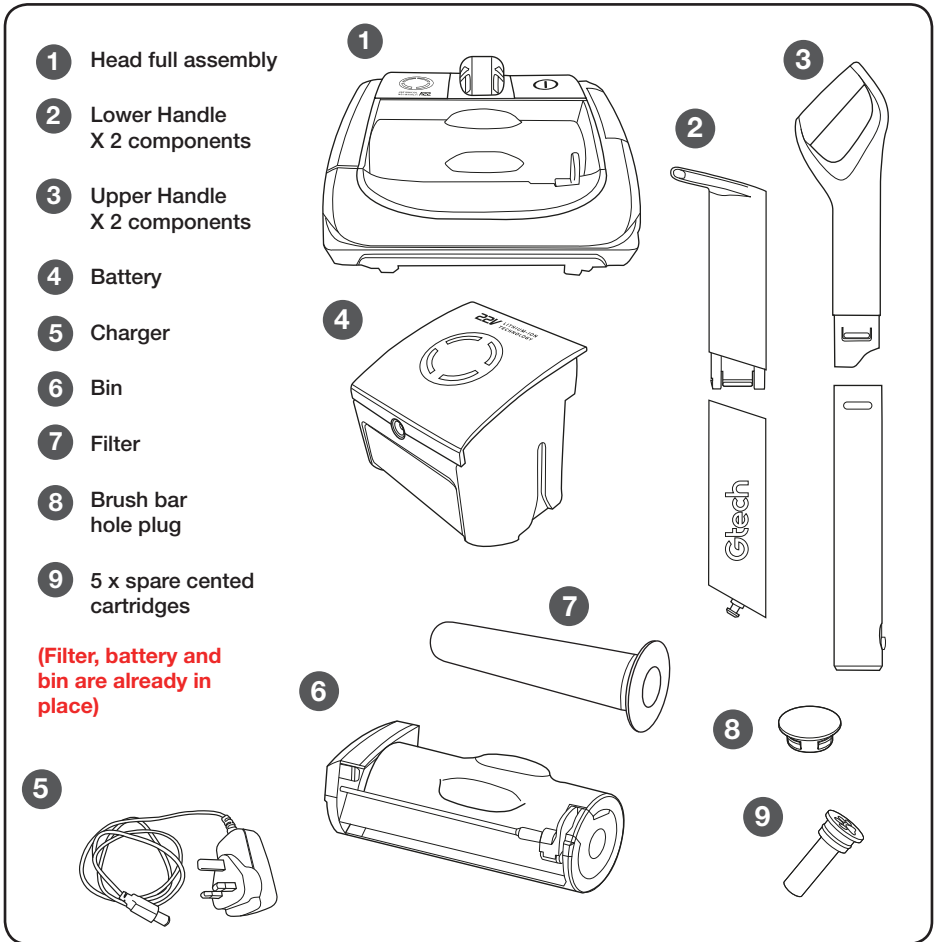

PRODUCT SERIAL NUMBER:

You can find this on the underside of your product

Assembly

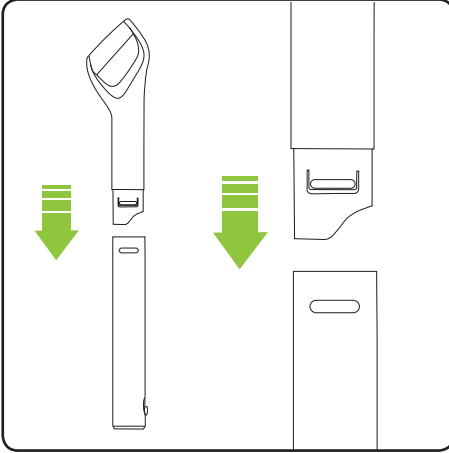

Fit the two components of the Upper Handle together in the orientation shown in the image above. They will only fit together one way. The components will click into place and will remain permanently fixed.

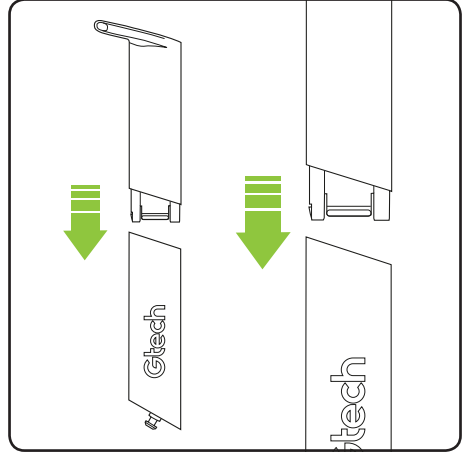

Fit the two components of the lower handle together in the orientation shown in the image above. They will only fit together one way. The components will click into place and will remain permanently fixed.

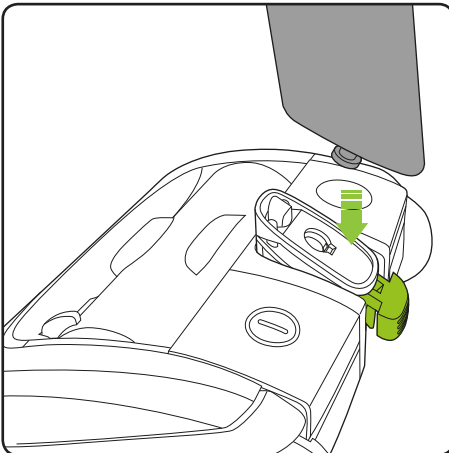

To attach the lower handle to the head assembly, insert the metal pin on the lower handle into the hole located on the pivot yoke. Make sure the green locking clip is unlocked to allow the lower handle to fit.

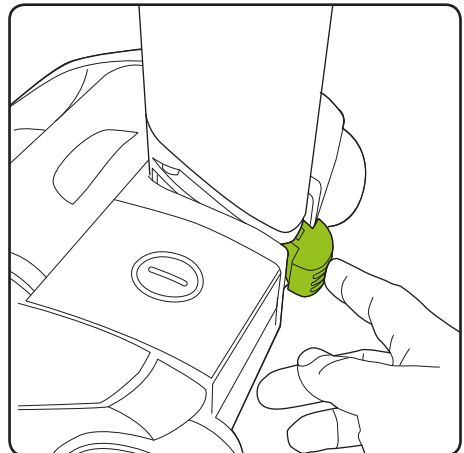

Ensure the lower handle is sitting completely flush against the yoke. Then push the green locking clip into the back of the head.

Assembly (continued)

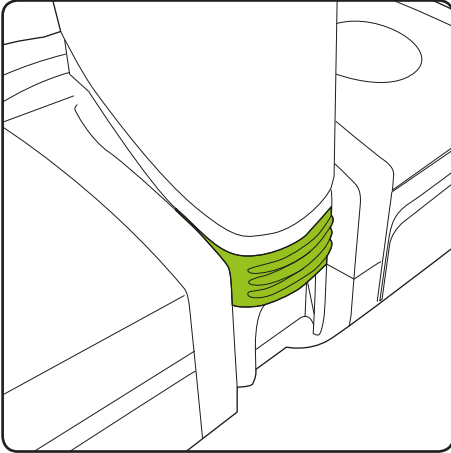

The green locking clip, when correctly fitted, will click and hold the lower handle in place. Should the handle assembly need to be removed the clip can be pulled out to unlock the lower handle.

The green locking clip remains permanently attached to the head assembly.

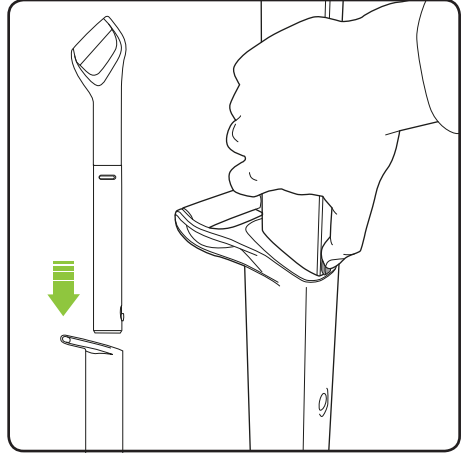

Insert the upper handle into the lower handle. You will need to press the button on the upper handle to fit it in. Once it slides down you will hear it click into place.

Storage

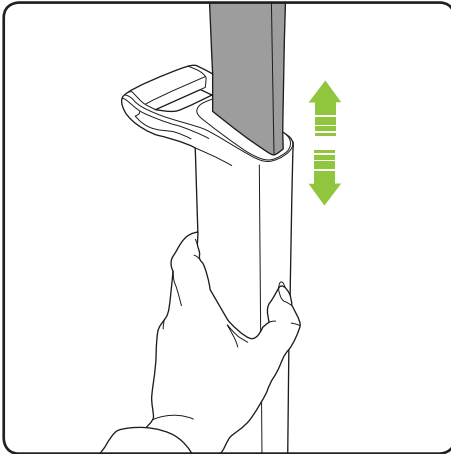

To stow or extend the upper handle simply press the button on the lower handle to unlock the upper handle.

The upper handle will now slide up or down depending on required position.

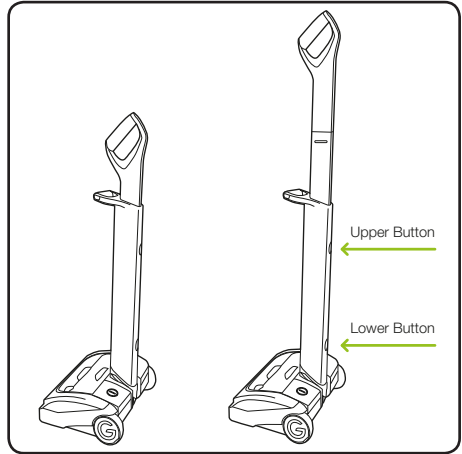

The upper handle can be set in two positions: Lowered for storage and raised for use. To lower the handle, release the upper button. To raise the handle from the stored position, release the lower button.

Installing scented cartridge

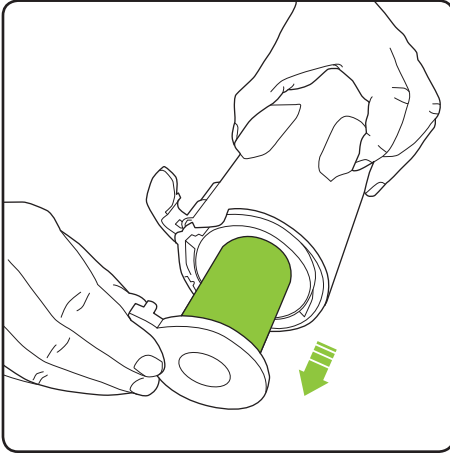

Slide the filter and inner shroud out of the filter housing.

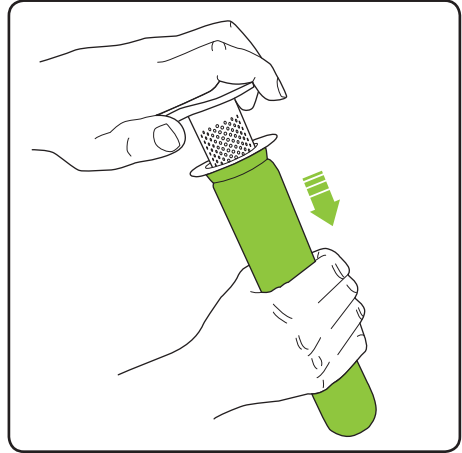

Remove the filter from the inner shroud, by twisting and pulling.

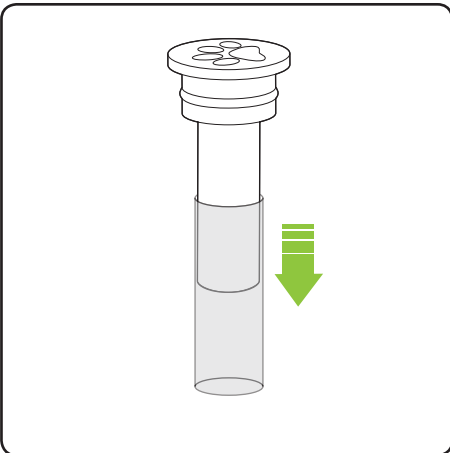

Remove the scented cartridge from its box then slide the plastic sleeve off.

Please refer to page 14 for scented cartridge health warnings.

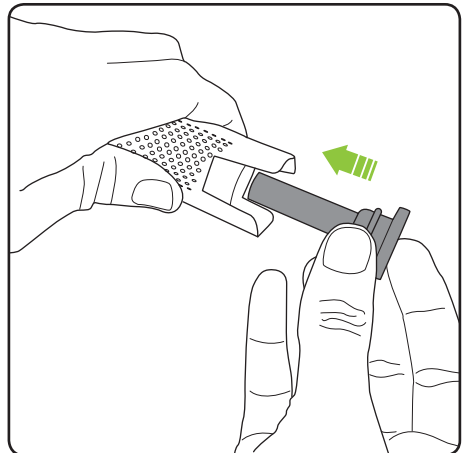

Slide scented cartridge into the end of the shroud. Replace filter and return to filter housing.

Operation

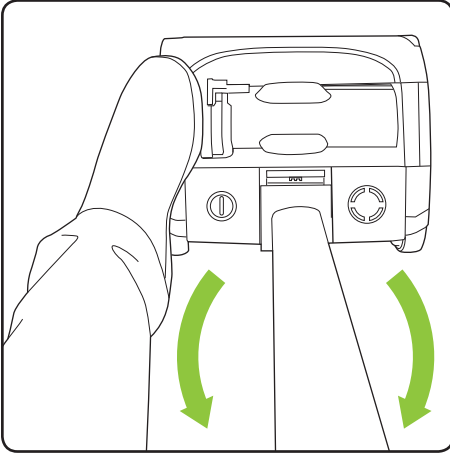

Without pressing the power button, place your foot on the left side of the AirRam K9 head and pull the handle back.

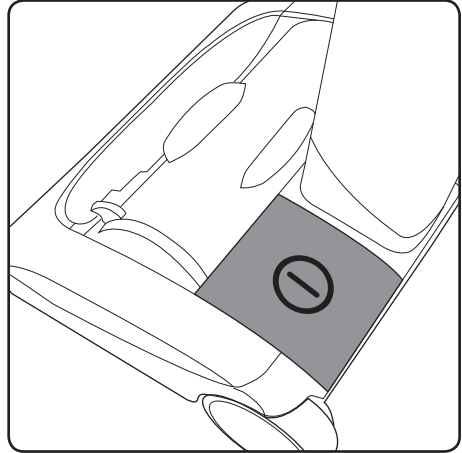

The power button is located on the left hand side of the AirRam K9 head assembly.

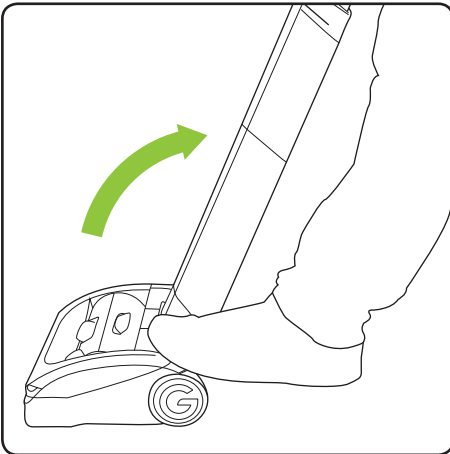

Press the power button with your foot to turn the AirRam K9 on.

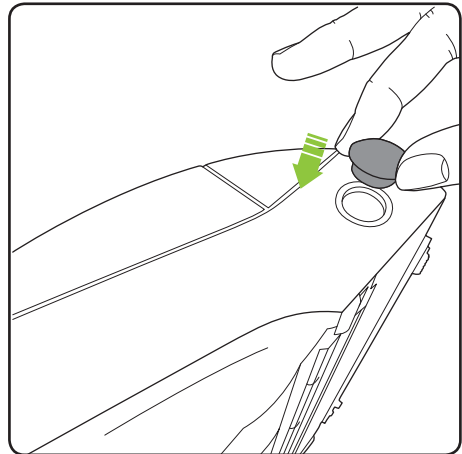

To get the best performance on hard floors with deep crevices remove the brush bar as shown on page 12. Insert the supplied brush bar hole plug into the side of the head assembly as shown in the image above.

Battery charging

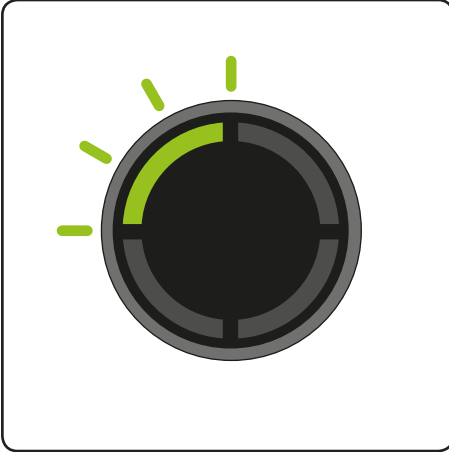

When the state of charge indicator starts to flash one green LED, recharge the battery.

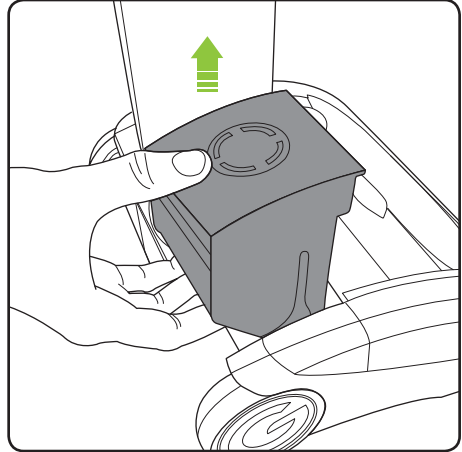

The battery can be charged whilst it's in the AirRam, or when it's off the product. To remove the battery, squeeze the latch underneath and pull upwards.

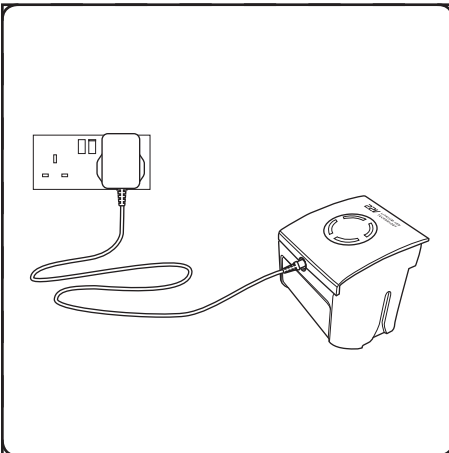

Plug the charger into the mains and connect it to the battery. Switch on at the mains.

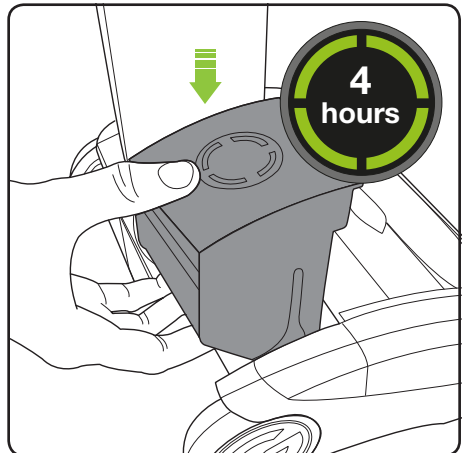

The battery can be charged from flat in 4 hours. The state of charge indicator will show 4 solid green lights when it is charged. It is OK to charge for 1 hour for a burst of cleaning.

Replace the battery by sliding it down into the head assembly. It will click into place.

Emptying the bin

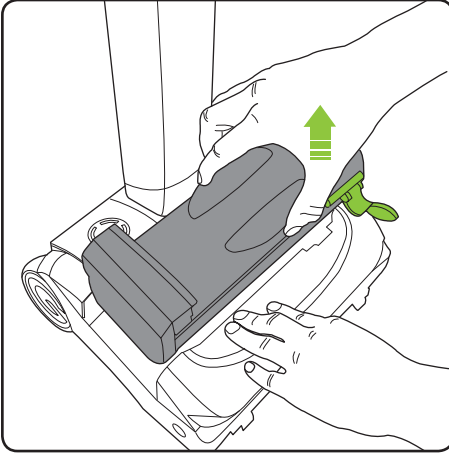

Holding onto the AirRam K9 with one hand, pull the bin handle and lift the bin out of the AirRam.

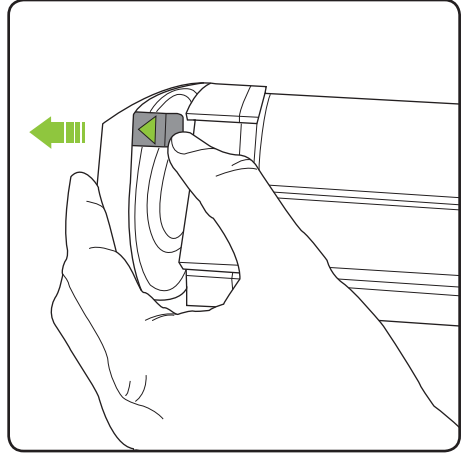

Release the latch with the green arrow, to pull open the bin lid.

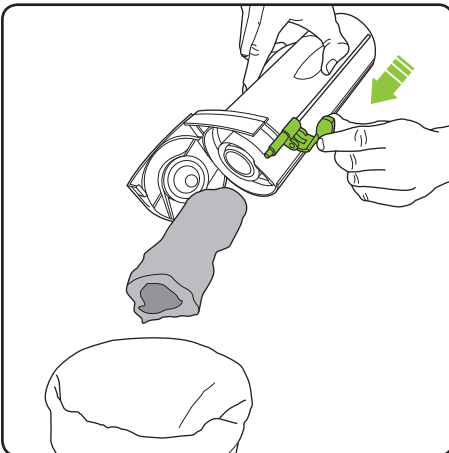

Hold the AirRam's bin over a rubbish bin and push the green lever towards the lid to empty the dirt.

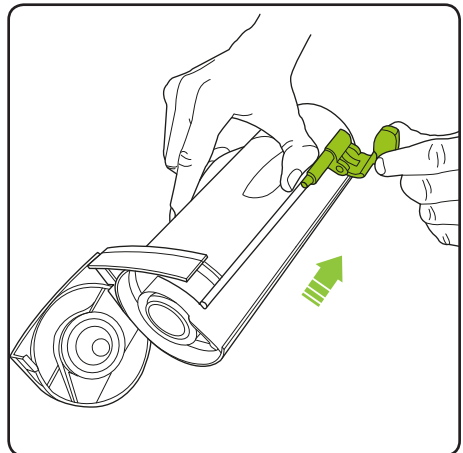

Pull the green lever back towards the bottom of the bin. Close the bin lid and reinsert the bin into the AirRam.

Cleaning the filters - do this once a month or more frequently depending on use.

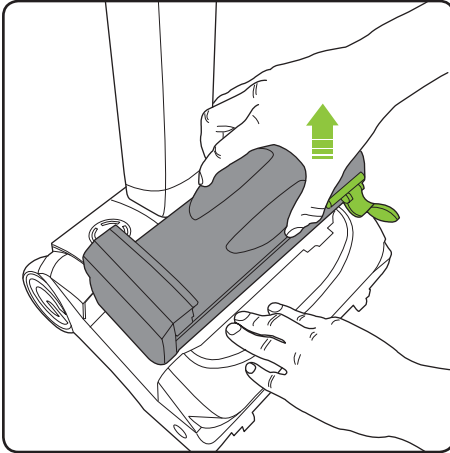

Holding onto the AirRam K9 with one hand, pull the bin handle and lift the bin out of the AirRam.

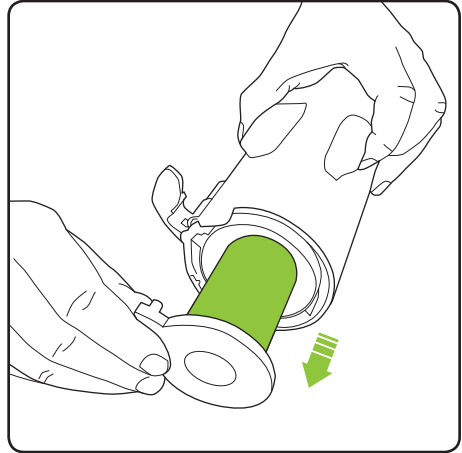

Pull the filter out of the filter housing. Tap the dirt from the filter and tip any dirt from the filter housing. Wash the filter if necessary.

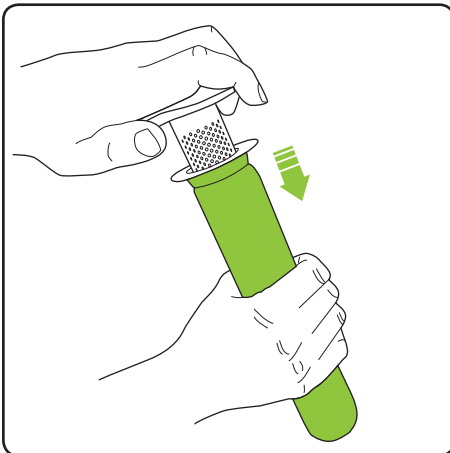

Remove the filter from the inner shroud, by twisting and pulling. Tap the inner shroud over a bin to remove any excess dirt.

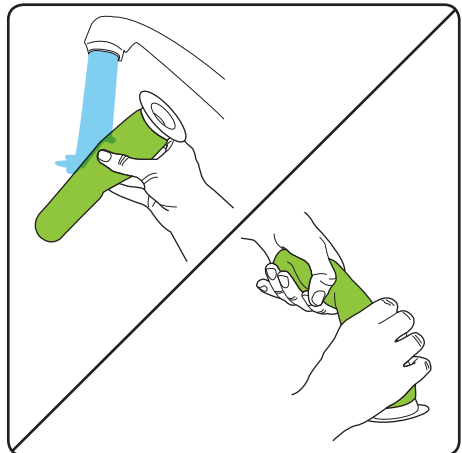

Wash the filter under a tap. Squeeze out any excess water then let it **dry completely** before reinserting into the AirRam. Recommended water temp 40°C do not use detergent. **Never put bin back without filter inside. You could damage the motor.**

Replacing the filters

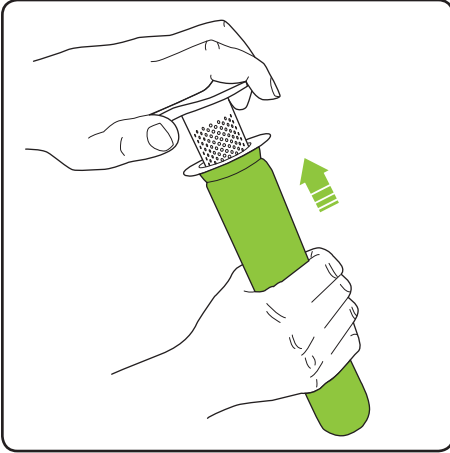

Slide the filter onto the inner shroud.

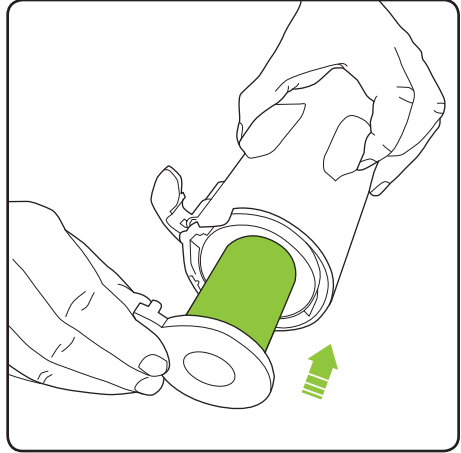

Slide the filter and inner shroud into the filter housing.

Removing and cleaning the brush bar

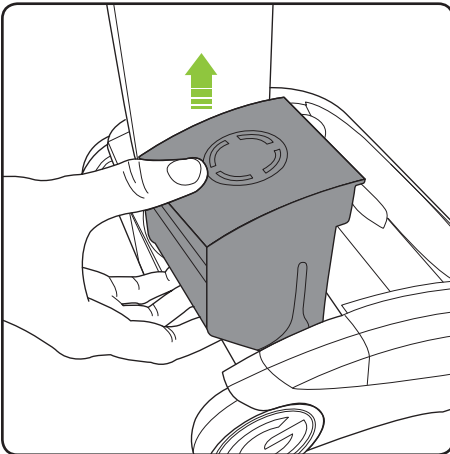

If the brush bar jams during use, the AirRam K9 will stop and the LEDs will appear red. Before checking for a blockage, remove the battery.

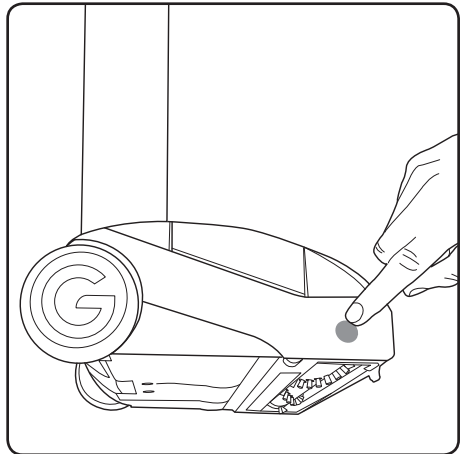

Rest the AirRam K9 on its side and locate the brush bar button on the right hand side. Press the button inwards and then pull the brush bar out from the bottom of the AirRam.

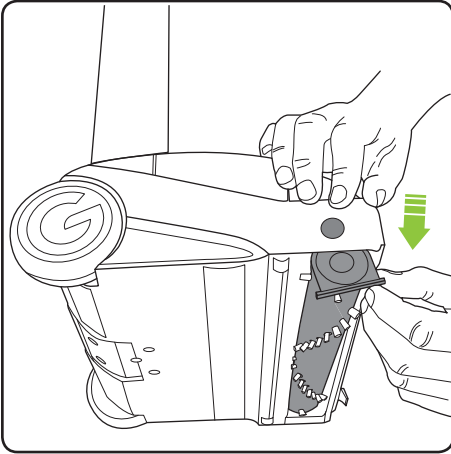

The brush bar can now be removed, starting at the button end.

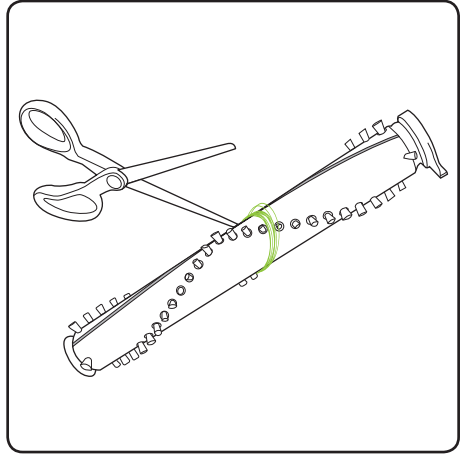

To remove hair from the brush bar, run an open pair of scissors down the groove to cut the hair, then pull it out.

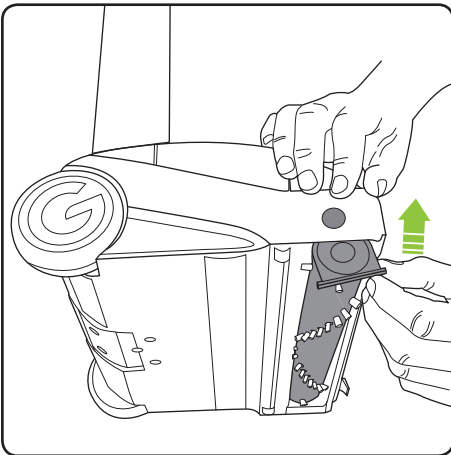

Re-insert the brush bar, starting by the end furthest away from the button. Then line up and push the brush bar into the AirRam K9 until it clicks into place.

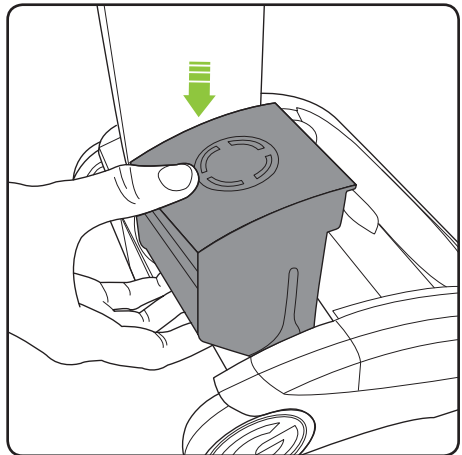

Replace the battery by sliding it down **into the head assembly.** It will click into place.

Clearing a jam / fault

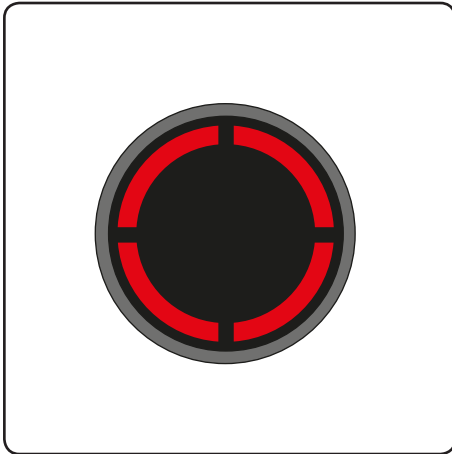

If the brush bar jams during use, the AirRam K9 will stop and the LEDs will appear red. You will need to remove and clean the brush bar (see page 11).

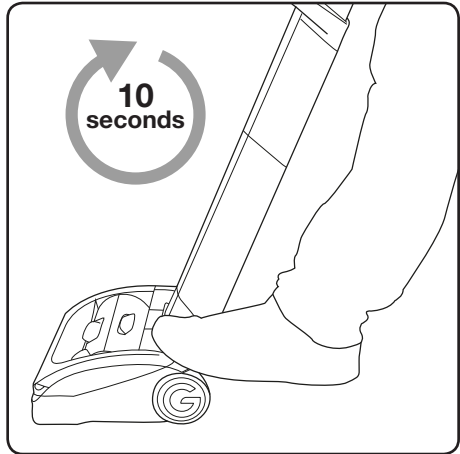

The AirRam K9 will not re-start until the red lights go out. This will take ten seconds.

If the problem persists, follow the troubleshooting instructions below.

Scented Cartridge

Scented cartridge refills: Keep out of the reach of children. People suffering from perfume sensitivities should be cautious when using this product as it may produce an allergic reaction or cause sensitisation by skin contact. If swallowed, seek medical advice immediately and show this container or label. Toxic to aquatic organisms, may cause long-term adverse effects in the aquatic environment. Scented refills contain: Linalyl acetate, Limonene, Linalool, Linal, Lavender oil, Vanillin, Borneol, Polysorbate 20

Troubleshooting

AirRam K9 is not cleaning well	<ol style="list-style-type: none">1. Empty the bin2. Check bin is correctly fitted3. Check filter is correctly fitted4. Clean and/or replace filter5. Check brush bar fitment
AirRam K9 has stopped or won't work	<ol style="list-style-type: none">1. Charge battery2. Clear debris from brush bar
Battery will not charge	<ol style="list-style-type: none">1. Check the charger is correctly connected to the battery and mains supply2. Check wall socket
If this doesn't solve your problem don't worry, we will help. Go to www.gtech.co.uk/support or call 01905 345 891	

Product Care

Your Gtech AirRam K9 doesn't need much maintenance: keep the filters clean, keep the brush bar tangle-free and charge the battery. Wipe it with a dry cloth if it gets dirty, including under the bin.

AIRRAM K9 TECHNICAL SPECIFICATION

Battery model	103A022
Battery	22V 2000mAh Li-Ion
Charging period	4 hours
Battery charger output	27V DC 500mA
Weight	3.3kg

The  symbol indicates that this product is covered by legislation for waste electrical and electronic products (EN2002/96/EC)

When the vacuum has reached the end of its life, it and the Li-Ion battery it contains should not be disposed of with general household waste. The battery should be removed from the vacuum and both should be disposed of properly at a recognised recycling facility.

Call your local council, via amenity site, or recycling centre for information on the disposal and recycling of electrical products.

Alternatively visit www.recycle-more.co.uk for advice on recycling and to find your nearest recycling facilities.



FOR HOUSEHOLD USE ONLY

WARRANTY – TERMS AND CONDITIONS

If your Gtech AirRam K9 breaks, don't worry, we're here to help. Go to www.gtech.co.uk or call 01905 345 891 for assistance.

The warranty on your AirRam K9 is 2 years from date of purchase.

WHAT ISN'T COVERED

Gtech does not guarantee the repair or replacement of a product as a result of:

- Normal wear and tear (e.g. filters, brush bar)
- Accidental damage, faults caused by negligent use or care, misuse, neglect, careless operation or handling of the vacuum cleaner which is not in accordance with Gtech AirRam K9 operating manual.
- Blockages - please refer to the Gtech AirRam K9 operating manual for details of how to unblock your vacuum cleaner.
- Use of the vacuum cleaner for anything other than the normal domestic household purposes.
- Use of parts and accessories which are not Gtech genuine components.
- Faulty installation (except where installed by Gtech)
- Repairs or alterations carried out by parties other than Gtech or its authorised agents.
- If you are in doubt as to what is covered by your guarantee, please call the Gtech Customer Care Helpline on 01905 345 891.

SUMMARY

- The guarantee becomes effective at the date of purchase (or the date of delivery if this is later).
- You must provide proof of delivery/purchase before any work can be carried out on the vacuum cleaner. Without this proof, any work carried out will be chargeable. Please keep your receipt or delivery note.
- All work will be carried out by Gtech or its authorised agents.
- Any parts which are replaced will become the property of Gtech.
- The repair or replacement of your vacuum cleaner is under guarantee and will not extend the period of guarantee.

Notes

Notes



Grey Technology Limited

Brindley Road, Warndon, Worcester WR4 9FB

email: support@gtech.co.uk

telephone: 01905 345891

www.gtech.co.uk