

Fittings

Ⓐ Screw x 4



Ⓑ Nut x 4



Ⓒ Hex Key x 1



Ⓓ Wrench x 1



Components

Ⓔ x 2pcs

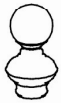

Ⓕ x 2pcs

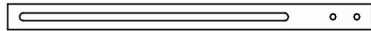

Ⓖ x 1pc

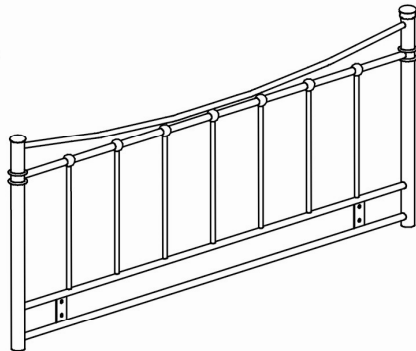

Alderley 5ft Headboard

Simple Assembly instructions -Please keep for future reference

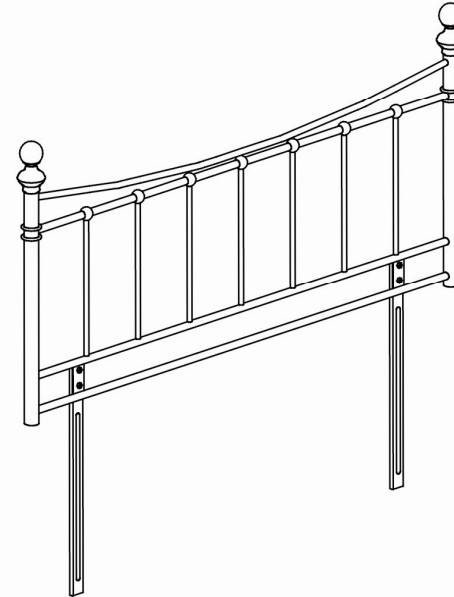

Before you start, here is some helpful advise

1. We suggest you spend a short time reading through this leaflet and then follow the simple step by step instructions.
2. If you follow the instructions carefully the end result should be worth the effort.
3. Do not discard any of the packaging until you have checked that you have all the parts and the pack of fittings.
4. Assemble this product on a flat floor.
5. To ensure an easier assembly, We strongly advise that all fittings are only finger tightened during initial assembly. Only upon completion of the assembly should all fixing points be fully tightened.
6. We recommend a periodic check on all fixing points to make sure they remain fully tightened.
7. Keep glue and fittings out of children's reach.

Assembly Instructions

Step 2:
Assemble the headboard posts (F) onto main Headboard Frame using screws (A) and Nut (B), tighten with Hex Key (C) and Wrench (D).

Step 1:
Assemble the finial (E) into headboard (G).

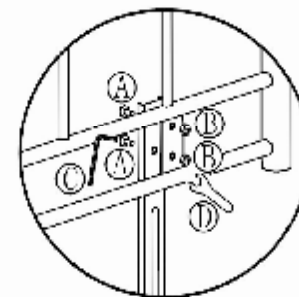
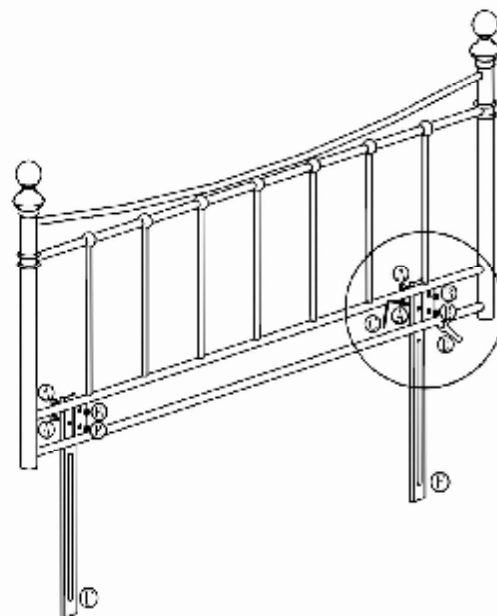
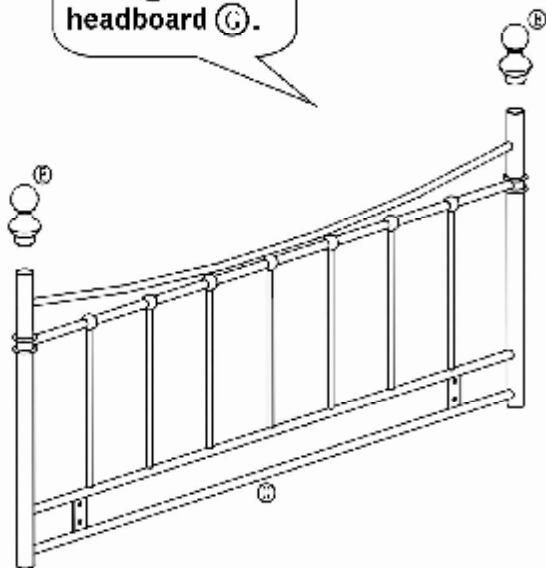

Care and Maintenance

Safety

To avoid any risk of suffocation to animals or children dispose of the plastic bags immediately.

Cleaning

As with all surfaces clean with a damp cloth and mild detergent, do not use bleach or abrasive products.

Fitting

From time to time please ensure there are no loose screws on the product.

Alderley 5ft Headboard

Assembly Instructions - Please keep for future reference

634/1457

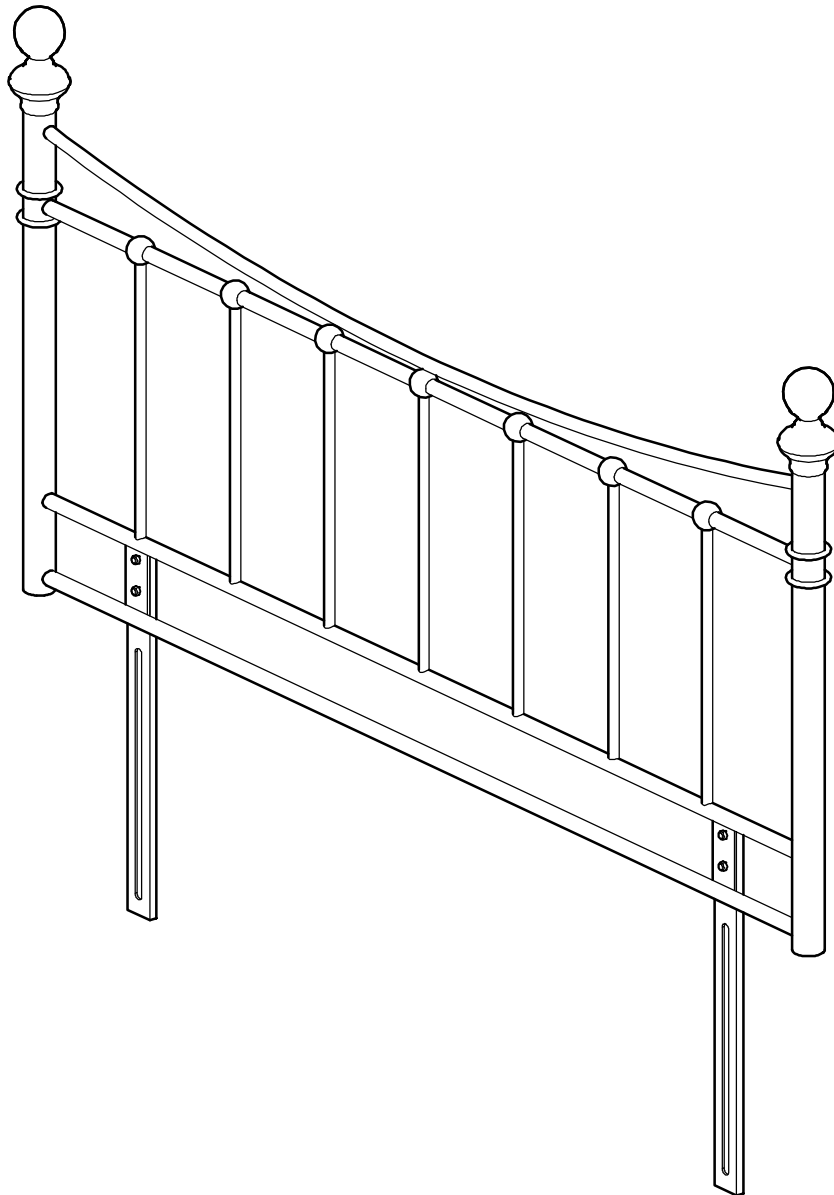

Dimensions

Width - 163cm

Height - 123cm

Important – Please read these instructions fully before starting assembly

If you need help or have damaged or missing parts, call the **Customer Helpline: 0845 6400800**



Safety and Care Advice

Important – Please read these instructions fully before starting assembly

- Check you have all the components and tools listed on page 2.
- Remove all fittings from the plastic bags and separate them into their groups.
- Keep children and animals away from the work area, small parts could choke if swallowed.
- Make sure you have enough space to layout the parts before starting.

- As you unpack and prepare for assembly, clear an area for assembly. The parts should be placed on a carpeted or padded area to protect them from damage.
- Parts of the assembly will be easier with 2 people.
- Do not discard any of the packaging until you have checked that you have all the parts and pack of fittings.

- We do not recommend the use of power drill/drivers **for inserting screws**, as this could damage the unit. Only use hand screwdrivers.

- To ensure an easier assembly, we strongly advise that all fittings are only finger tightened during initial assembly. Only upon completion of the assembly should all fixing points be fully tightened.



Care and maintenance

- Only clean using a damp cloth and mild detergent, do not use bleach or abrasive cleaners.
- From time to time check that there are no loose screws on this unit.
- This product should not be discarded with household waste. Take to your local authority waste disposal centre.

Components - Panels

If you have damaged or missing components, call the **Customer Helpline: 0845 6400800**

Please check you have all the panels listed below

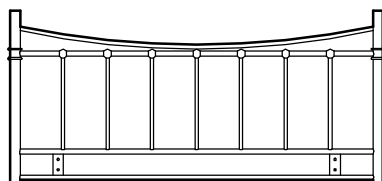

1 Headboard frame
(160.6 x 66cm)



2 Leg x 2 (61 x 4cm)

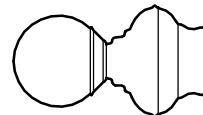





3 Finial x 2 (dia 7.3 X 12.9cm)

Components - Fittings

Please check you have all the fittings listed below

Note: The quantities below are the correct amount to complete the assembly. In some cases more fittings may be supplied than are required.

<p>A  17mm Bolt x 4</p>	<p>B  Nut x 4</p>	<p>C  Hex key x 1</p>
<p>D  Wrench x 1</p>		

Ruler - Use this ruler to help correctly identify the screws

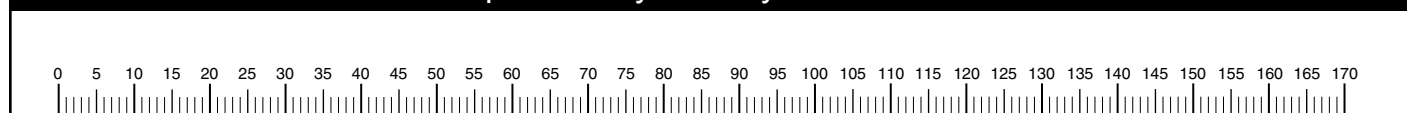

Assembly Instructions

Step 1

Assemble leg

Assemble legs **2** to headboard frame **1** using bolts **A** and nuts **B** and secure tightly.

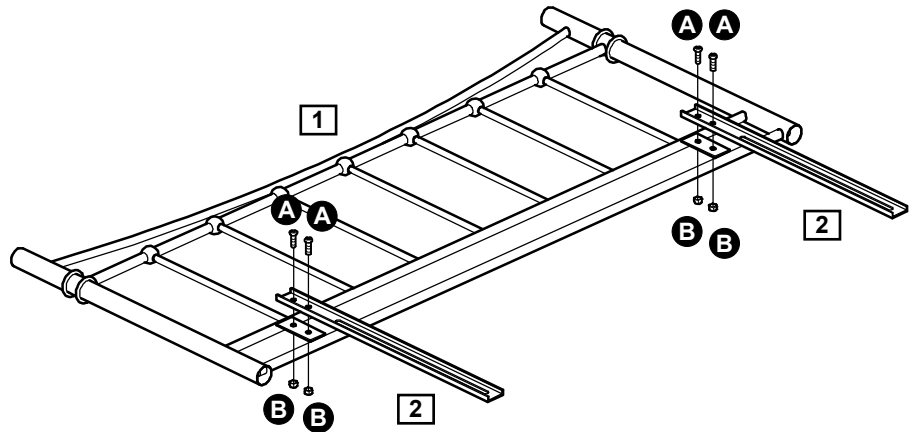

Step 2

Assemble finial

Assemble finials **3** to headboard frame.

Assembly is complete.

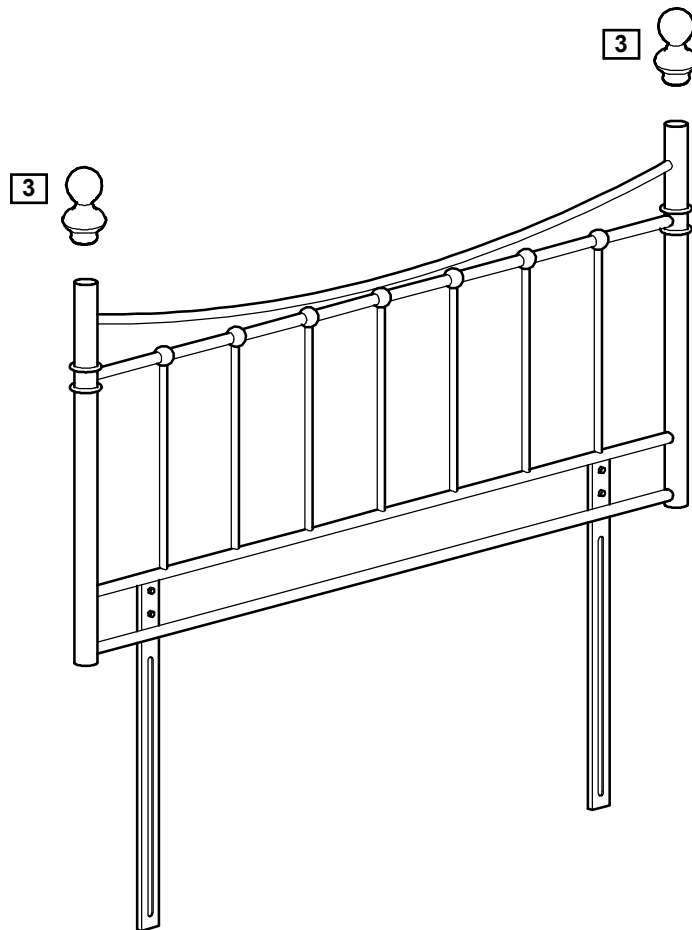

If you need help or have damaged or missing parts, call the **Customer Helpline: 0845 6400800**