

VC720520MUK Rev1

morphy richards[®]
smart ideas for your home



Upright and Handheld Steam Cleaner

 Please read and keep these instructions for future use

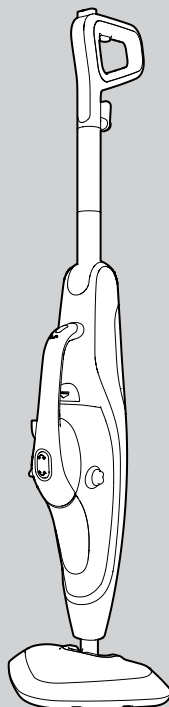

IMPORTANT: To prevent limescale problems which would not be covered by the guarantee, use only deionised / demineralised / distilled water (available from most large supermarkets), or softened water from a Morphy Richards water softener bottle



Additional microfibre floor cloths may be purchased by calling our UK helpline directly on: **0344 873 0710**

For competitions, product hints and tips and more join us at



www.morphyrichards.co.uk/blog



www.facebook.com/morphyrichardsuk



[@loveyourmorphy](https://twitter.com/loveyourmorphy)

www.morphyrichards.com

* Register online for your 2 year guarantee. See back of this instruction book for details. (UK and Ireland customers only)

Health and Safety

The use of any electrical appliance requires the following common sense safety rules. Please read these instructions carefully before using the product.

- **WARNING: Disconnect from the mains supply before carrying out any routine maintenance.**
- This appliance can be used by persons with reduced physical, sensory or mental capabilities, or lack of experience and knowledge, if they have been given supervision or instruction concerning the use of the appliance in a safe way and understand the hazards involved.
- Children shall not play with the appliance.
- Keep the appliance out of reach of children when it is energized or cooling down.
- The appliance is not to be used if it has been dropped, if there are visible signs of damage or if it is leaking.
- The appliance must not be left unattended while connected to the supply mains.
- If the supply cord is damaged, it must be replaced by the manufacturer, its service agent, or similarly qualified person to avoid a hazard.

Personal safety

- **WARNING: Never direct steam at electrical components or fittings. If in doubt about the suitability of steam for cleaning an appliance, contact the appliance manufacturer for advice prior to cleaning.**
- **WARNING: Never touch the plug or cable with wet hands.**
- **WARNING: Nozzles and tools will be hot after use. Allow to cool before attempting to remove.**
- **WARNING: Misuse of the appliance could cause injury.**
- **WARNING: Do not discharge the steam towards people or animals. Danger of scalding.**
- **WARNING: Do not use the appliance without the filler cap in place.**
- **WARNING: In the event of a blockage, steam will be released from the steam relief vent.**
- To protect against fire, electric shock and personal injury, do not immerse cord, plug or cleaner in water or other liquid.
- The plug should be removed from the wall socket after use, before cleaning, filling or changing the accessories, or carrying out user maintenance.
- Repairs to electrical appliances are only to be undertaken by trained personnel.
- Unprofessional repairs can be dangerous for users.
- Do not use or keep this product outside.

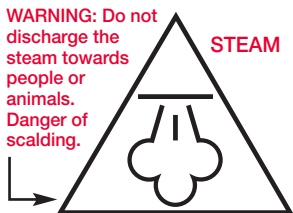

Mains cable

- **WARNING: A damaged or severed mains cable fitted with a plug should never be connected to the mains supply. It must be destroyed, as a damaged cable becomes hazardous if connected to a power socket.**
- Do not allow the mains lead to become strained.

Product safety

- Do not store the appliance near hot surfaces eg. ovens or heating appliances.
- Never modify the steam cleaner in any way.

- Never operate the steam cleaner without water in the tank. Always top-up with water during extended periods of use.
- **Do not use any chemical detergents, perfumes, alcohol or descaler etc in water.**
- Use only genuine Morphy Richards spare parts and accessories.
- This steam cleaner is intended for domestic use only. Misuse or use for commercial or any other purpose will render the guarantee invalid.

Electrical requirements

- Check that the voltage on the rating plate of your appliance corresponds with your house electricity supply which must be A.C. (Alternating Current).
- **WARNING: This appliance must be earthed.**
- Should the fuse in the mains plug require changing, a 13 amp BS1362 fuse must be fitted.

Contents

Health and safety 2

Electrical requirements 3

Product overview / Features 4

Operating the appliance 5

Dual functionality 5

Dual water tanks 5

Upright steam cleaner 6, 7 & 8

Upright steam cleaning: assembly 6

Filling the water tank in upright mode 6

Using in upright steam cleaning mode 7 & 8

Handheld steam cleaner 9, 10 & 11

Using the handheld steam cleaner 9

List of attachments for use on the handheld steam cleaner 10

Two handheld steam cleaner positions 11

Refitting the handheld steam cleaner 11

Steam relief vent 12

After use 12

Storage 12

Maintenance 13

Contact us 13

Notes 13, 14 & 15

Guarantee 16

Product overview

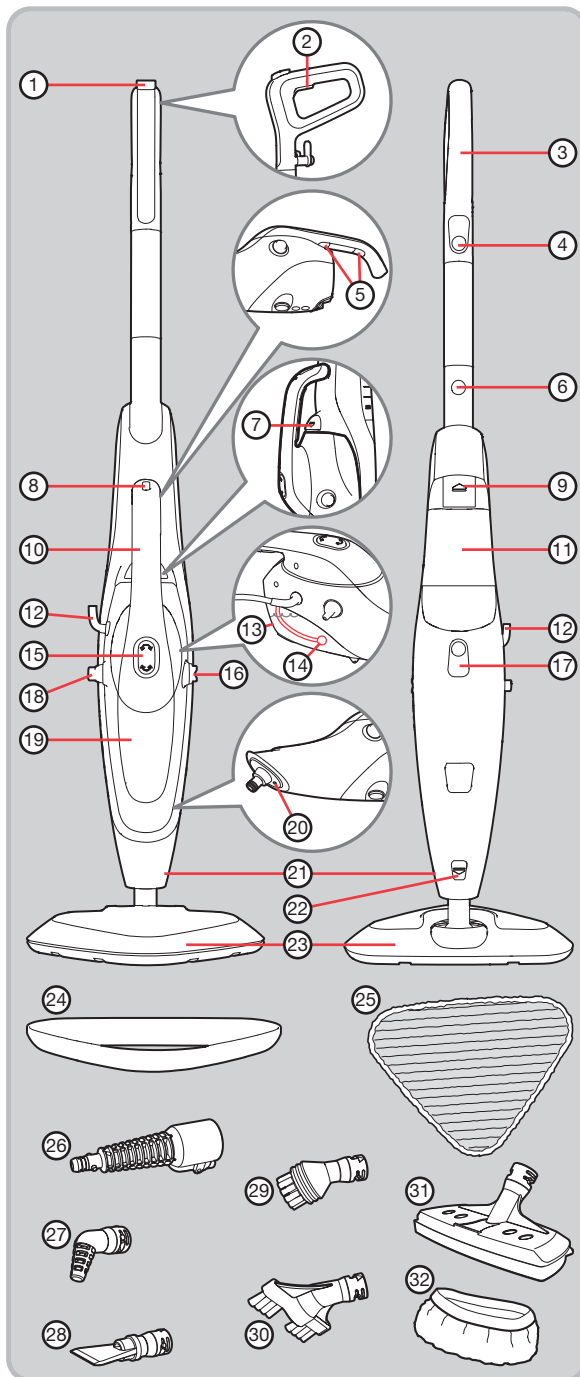

Features

- (1) Back saver handle release button
- (2) Steam trigger
- (3) Handle
- (4) Upper cord storage hook (rotatable)
- (5) Steam triggers (on underside of the handle of the handheld steam cleaner)
- (6) Handle removal catch
- (7) Handheld release button
- (8) Temperature indicator light and handheld steam lock/unlock button
- (9) Upright water tank release button
- (10) Handheld handle
- (11) Upright water tank with filler cap
- (12) Power cord
- (13) Handheld water tank
- (14) Water tube with brass ball weight attached (inside product)
- (15) Handheld handle rotate button
- (16) On/Off power switch
- (17) Lower cord storage hook (fixed)
- (18) Variable steam control
- (19) Handheld steam cleaner
- (20) Steam relief vent (on the handheld - see page 12)
- (21) Main body
- (22) Floorhead release button
- (23) Floorhead
- (24) Carpet glider
- (25) Microfibre floor cloth
- (26) Accessory adaptor
- (27) Jet nozzle
- (28) Scraper attachment
- (29) Round nylon brush
- (30) Crevice brush
- (31) Upholstery nozzle
- (32) Elasticated upholstery nozzle cloth

Operating the appliance

IMPORTANT: Please remember that the steam cleaner operates by emitting steam at an increased temperature of 115°C. Always test on an inconspicuous area first. Never use it on objects or surfaces which cannot resist this temperature, on surfaces with coatings or polishes, or on delicate materials such as dralon, plastic, natural fur or antique items etc.

If in doubt, check carefully on a part of the material where minor marks will not matter.

IMPORTANT: Do not use disinfectant, detergents, cleaning solutions, scented oils or scented water, bleach or vinegar in your steam product. They will cause damage to your product and invalidate your guarantee. We recommend you only use deionised or distilled water, or Morphy Richards water softener bottles to fill your steam cleaner.

Dual functionality

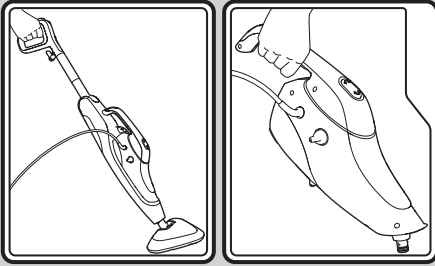

Upright steam cleaning Handheld steam cleaning

Your steam cleaner can easily be configured into two different cleaning modes:

- Upright for cleaning floors and freshening carpets.
- Handheld steam cleaner (19) for cleaning vertical or hard to reach surfaces.

Attachments (26-31) can be used on the handheld steam cleaner.

Dual water tanks

There are two water tanks which can be filled, one in the handheld unit and one in the main unit, depending on the cleaning mode required.

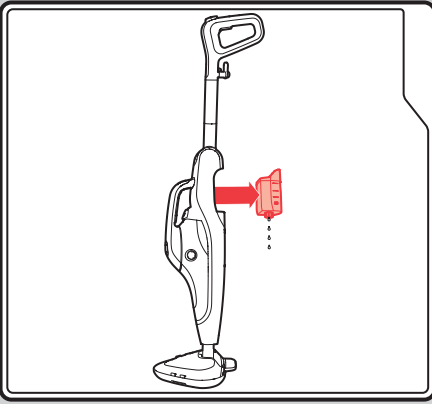
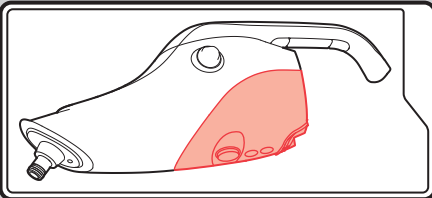

The brass ball weight (14)

The brass ball weight inside the handheld water tank (13) is attached to the end of the suction hose. The ball is weighted and designed to freely move around the water tank of the handheld steam cleaner (19). The ball must remain in the water so steam can be generated whenever the steam trigger is pressed regardless of the orientation of the handheld steam cleaner. If the ball does get stuck outside the water level, gently shake the product until it comes free.

Rinsing the water tanks

Regularly rinse both water tanks to release any deposits that have collected on the bottom of the tanks. Only use deionised, demineralised or distilled water (available from most large supermarkets) and fit the filler cap to allow vigorous rinsing.

Upright Steam Cleaner

Upright steam cleaning: assembly

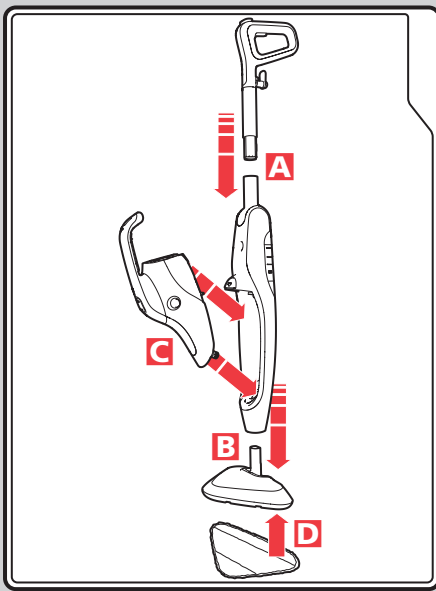

- A** Insert the handle (3) onto the main body (21).

NOTE: Attaching the handle is necessary for first time assembly only. If the handle needs to be removed, press the bottom of the handle removal catch (6) with a blunt tool or cross-head screw driver whilst pulling the handle up.

- B** Lower the main body onto the floorhead (23), until it clicks into place.

- C** Insert the steam outlet nozzle at the bottom end of the handheld steam cleaner (19) into the adaptor at the bottom of the space in the front of the main body.

Push the handheld steam cleaner firmly into the space in the main body until it clicks into place.

NOTE: If the floorhead (23) needs to be removed, press the floorhead release button (22) on the rear of the product. This must only be done when the product is switched off and cold.

- D** Attach the microfibre floor cloth (25) to the floorhead.

Filling the water tank in upright mode

To achieve longer steaming time, fill the upright water tank (11) on the back of the main body (21). Water from here will slowly filter down into the handheld water tank (13) in the handheld steam cleaner (19). Keep it topped-up for more prolonged usage.

Press the upright water tank release button (9) and remove the upright water tank. Tip the water tank upside down and unscrew the filler cap. Use a suitable filling jug to pour water into the upright water tank. Always ensure the water level is above the MIN water level marker. Never fill above the MAX water level marker.

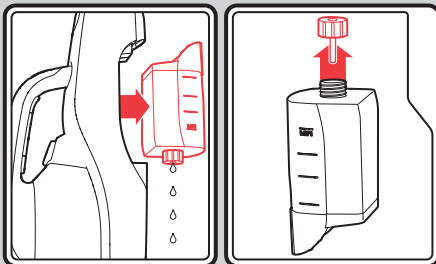

IMPORTANT: To prevent limescale build-up in the water tank, never fill your steam cleaner's tank with anything other than deionised, demineralised or distilled water (available from most leading supermarkets), or softened water from a Morphy Richards water softener bottle. Any problems arising from limescale will invalidate the product guarantee.

Replace the filler cap, turn the upright water tank back upright and reinstall it back into the main body.

NOTE: When removing or replacing the upright water tank and the filler cap, there may be some residual water in the tube of the upright water tank. When the tank is tipped back upright to refit to the main body, a small amount of water may drip from the cap.

Using in upright steam cleaning mode

IMPORTANT: Before use, hardfloors should be thoroughly swept and carpets should be thoroughly dry vacuumed. However, we recommend that your steam cleaner is not used on:

- bare wooden floors or any surfaces where wood is exposed (as it will absorb moisture and may distort).
- damaged hardfloors or hardfloors with gaps present (as it will absorb moisture and may distort).
- if unsure, always contact floor manufacturer to confirm if the floor can be cleaned with a steam cleaner.

Also, do not keep your steam cleaner in one place for an extended period, because the continual heat may cause damage to carpets and laminate flooring.

Please disconnect and allow the unit to cool before changing the cloth and attachments.

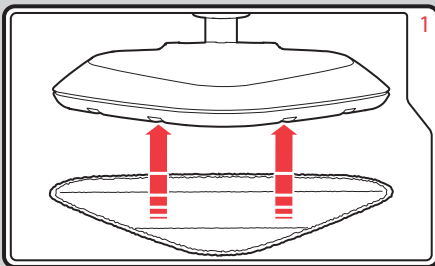

Attach the microfibre floor cloth (25) to the floorhead (23). Align the grip pads on the cloth to the corresponding pads on the underside of the floorhead.

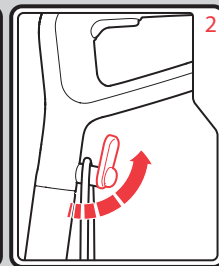
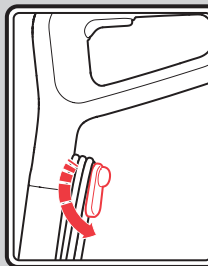

Rotate the upper cord storage hook (4) to quickly release the power cord (12).

You may rotate the upper cord storage hook back upwards to enable you to loop any excess power cord over it.

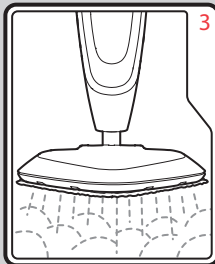
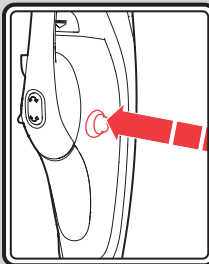

WARNING: Before switching ON, ensure the floorhead is located safely away from persons or animals.

Plug in at the mains outlet and switch on your steam cleaner at the On/Off power switch (16). The temperature indicator light (8) will flash red during heat up and illuminate steady blue when the steam is ready.

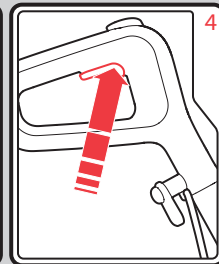
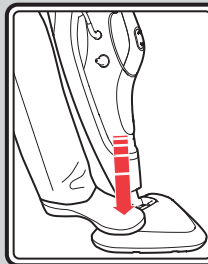

Place the floorhead (23) on the floor. Hold the floorhead to the floor with your foot and tilt the main body (21) back.

To emit steam, press the steam trigger (2) on the underside of the handle (3). To prevent over-saturation of the floor, operate the steam trigger intermittently (especially on hard floors).

Using in upright steam cleaning mode (continued)

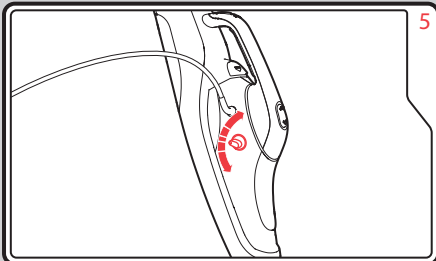

The variable steam control (18) varies the steam output. Turn the knob clockwise as far as it will go for the maximum amount of steam, or anti-clockwise to decrease the steam output.

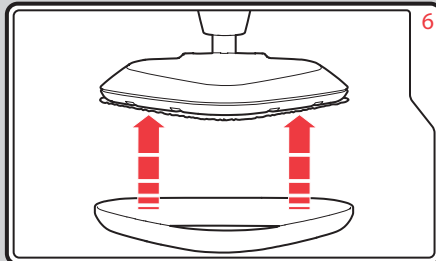

If freshening carpet, lower the floorhead, with floor cloth attached, into the carpet glider (24).

NOTE: This steam cleaner is not designed to wash/clean carpets.

NOTE: The carpet glider is designed to make it easier to move the floorhead across the carpet.

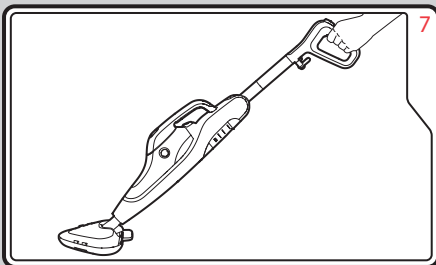

If cleaning floors under tables or chairs, press the back saver handle release button (1) to pivot the upright handle forwards, allowing the main body (21) to be parallel with the floor without you having to bend down.

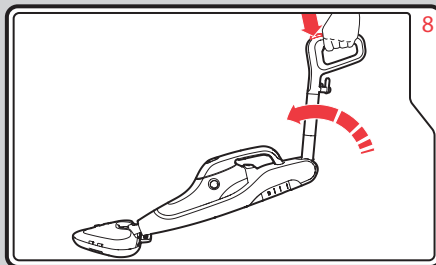

Handheld Steam Cleaner

Using the handheld steam cleaner

This function is ideal for cleaning vertical surfaces and hard to reach places.

1. Separate the handheld steam cleaner (19) from the main body (21) by firmly pressing the handheld release button (7) exactly where the arrow is marked. Once you hear the click, pull the handheld steam cleaner up and out of the main body. Do not remove the handheld steam cleaner until the click is heard.

NOTE: There may be some excess water dripping from the valves on the inside of the product, this is normal.

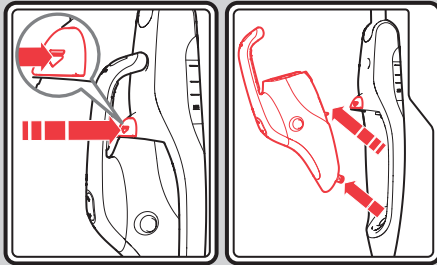

2. If it is necessary to fill the handheld water tank, turn the handheld steam cleaner upside down and unscrew the filler cap lid. Use a suitable filling jug to pour water into the handheld water tank (13) until the tank is full.

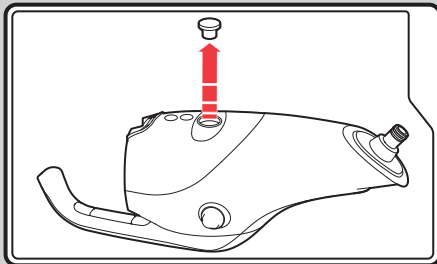

IMPORTANT: To prevent limescale build-up in the water tank, never fill your steam cleaner's tank with anything other than deionised, demineralised or distilled water (available from most leading supermarkets), or softened water from a Morphy Richards water softener bottle. Any problems arising from limescale will invalidate the product guarantee.

3. Plug in at the mains outlet and switch on your steam cleaner at the On/Off power switch (16). The temperature indicator light (8) will flash red during heat up and illuminate constantly red when ready.
4. To activate the handheld steam cleaner, press the handheld steam lock/unlock button (8) on the end of the handheld handle (10), it will illuminate blue - this indicates the steam release is unlocked. Press either of the steam triggers (5) to release the steam.

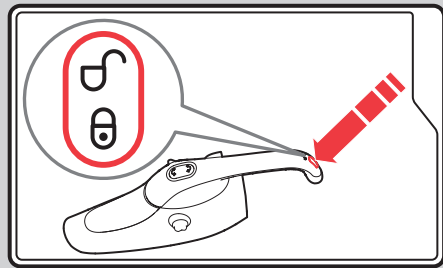

Steam lock/un-lock button light indicator settings

'Flashing' red light This appears when the product is first switched on and continues for approximately 30 seconds. This indicates heat-up is in progress. The steam triggers will not operate during this heat-up time. When the heat-up is complete the indicator light will change to either solid red (if the hand-held is detached) or blue if the hand-held is fitted to the upright body.

Solid red light This light only appears when the hand-held unit is removed from the upright section. This light indicates that the steam triggers of the hand-held are locked so no steam can be accidentally released, this is a safety feature. To unlock the steam triggers press the centre of this unlock/lock button. When unlocked the light will change to a solid blue colour. If either of the steam triggers are not pressed for 60 seconds, the light will return to solid red, indicating that the triggers have automatically locked again.

Solid blue light When this is illuminated, this indicates that the steam is ready, and by pressing the steam triggers steam will be emitted.

5. The steam output can be varied (see step 5 of 'Using in upright steam cleaning mode' on page 8).

List of attachments for use on the handheld steam cleaner

Accessory adaptor (26) this attachment is the base attachment for all handheld accessories supplied with the product.

It can also be used alone to clean places or crevices that are not easily accessible.

Jet nozzle (27) to clean sanitary ware such as toilet bowls, taps or drain covers. Point it directly at non-permanent stains on carpets or upholstery whilst holding a clean cloth near the stained area to capture any loosened dirt.

Scraper attachment (28) to remove stubborn deposits, or to help de-ice the refrigerator or freezer.

Round nylon brush (29) to remove stains on room-temperature surfaces, such as tiles, mirrors and windows.

Crevice brush (30) to remove dirt from grooves and crevices.

Upholstery nozzle (31) when used with the elasticated upholstery nozzle cloth (32), cleans upholstery and bedding.

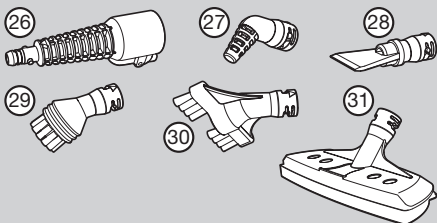

In order to use all of the accessories, the accessory adaptor (26) must firstly be attached onto the handheld steam cleaner (19). This can be done by completing the following:

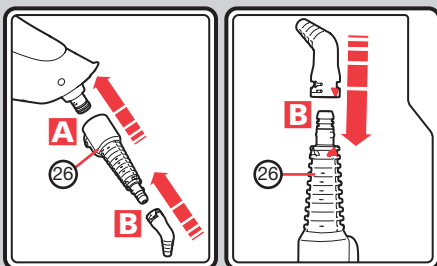

A Slide the adaptor over the nozzle of the steam cleaner and press firmly until the catches lock it in place.

B Attach the desired accessory to the end of the adaptor and twist the accessory to lock it to the adaptor.

Warnings

WARNING: Switch OFF and unplug before changing nozzles. After use, nozzles will be very hot, allow to cool before handling.

WARNING: When using in the handheld mode, only ever hold the product by the handheld handle (10).

NOTE: handheld mode has been designed for one-handed use.

The underside of the handheld steam cleaner (19) will become warm during use - this is normal. Never place the product on delicate surfaces that could be affected by heat.

Never block any nozzle, eg. by holding against a surface being cleaned. If the nozzles are blocked, steam will be released from the steam relief vent (20).

WARNING: After the steam trigger is released, steam will continue to be emitted for a few seconds while the steam reservoir inside the product empties - this is normal. Always keep a safe distance from the nozzle until all steam has stopped. Switch off, unplug and leave to cool before attempting to remove the nozzle or change the attachments as these will be very hot after use.

Two handheld steam cleaner positions

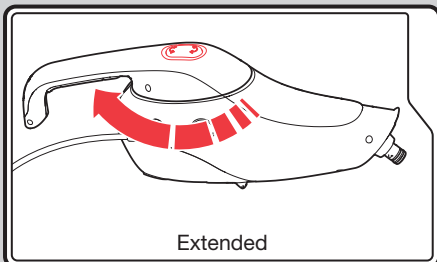
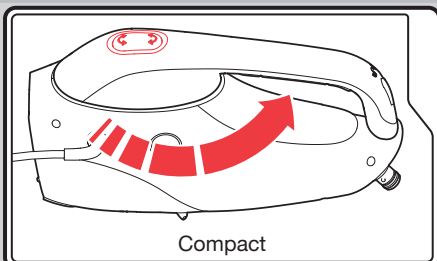

The handle may be used in two orientations: the compact, upright mode; or the longer reach extended mode. To change between the two modes, press the handle rotate button (15) and rotate the handle.

NOTE: The handle will only rotate in the reverse direction to which it was last moved, ie. if moved clockwise to extend the handle, it can only be closed by pressing the rotate button and reversing the direction it was last moved in.

There are two steam triggers on the underside of the handheld handle, so it can be used in either orientation.

Refitting the handheld steam cleaner

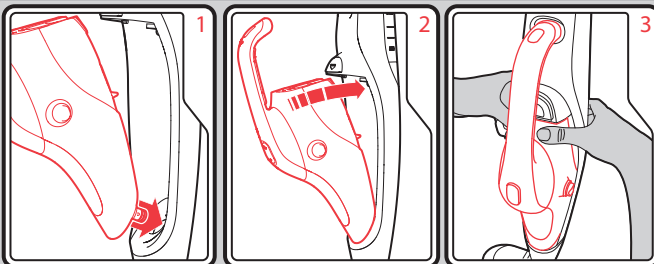

NOTE: When re-fitting the handheld steam cleaner (19), always locate the nozzle flush into the recess of the main body (21) first, then lift/tilt the handheld steam cleaner into the main body and press firmly (whilst supporting the rear of the main body) until it clicks/locks into place.

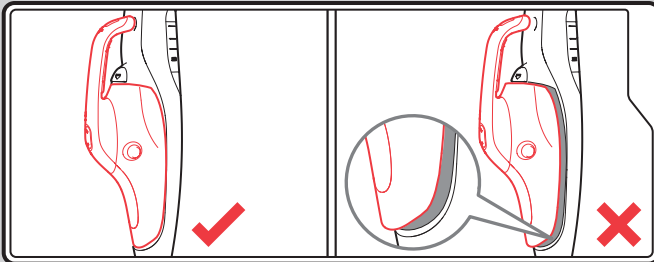

If there is a gap between the nozzle and the body, this means the handheld steam cleaner is not fitted correctly and will not click into place. The fit must always be snug with no gaps as highlighted opposite.

Steam Relief Vent (19)

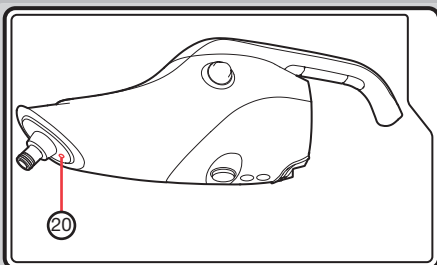

WARNING: In the event of the steam being blocked from escaping, the steam pressure may be relieved via a vent located underneath the steam outlet on the handheld steam cleaner. Never hold the product in the area of the steam relief vent (20).

Steam or hot water may be emitted from this vent but only if:

- the cleaning nozzle has been blocked, eg. by accidentally sealing it against a surface.
- the boiler has become blocked due to limescale caused by using hard water.

If steam is emitted from this vent, ie. if it is seen escaping from around the handheld steam cleaner, switch off, unplug and allow the product to cool. Please contact the consumer care helpline on 0344 871 0944 for further advice.

WARNING: Never attempt to use descaler in the product.

After use

Follow the two maintenance steps below after every use.

1. Switch the cleaner off and unplug from the socket. Place immediately on a suitable surface (eg. tiled floor) where the residual heat/moisture in the floor nozzle/cloth will not affect the surface. Wait until the cleaner has cooled down completely.
2. Empty the water tanks (11/13) by unscrewing the filler caps and pouring out the water. Allow the inside of the water tanks to dry out before replacing the filler caps.

Storage

We recommend storing your steam cleaner in the carpet glider (24), but with the cloth removed to minimise the likelihood of any water leaking onto surfaces.

Wrap the cord around the two cord storage hooks (4/17), rotating the upper storage hook (4) upwards to secure the power cord (12) in place.

