

BUSH

Instruction manual

CDVD100W1SWM

CDVD100W1SWMP



You'll soon be enjoying your new Portable DVD Player.

It all begins here, with your instructions. Don't worry, there's nothing too technical coming up. Just simple, step-by-step guidance to get you up and running quickly. Sound good? Then let's get started.

Help and Guidance

We're here to help you get the most from your Portable DVD Player. Should you require any guidance, a simple solution can often be found online at:

www.argos-support.co.uk

If you still require further assistance, call one of our experts on **0345 604 0105**.

Contents

1 Safety information

Safety information	6
--------------------	---

2 Getting to know your Portable DVD Player

Ready? Let's begin	10
Accessories	10
Front & side panel	11
Remote control	13
Installing the remote batteries	14
Battery disposal advice	14
Powering with mains power	14
Powering with the in-car power adaptor	14
Adjusting the swivel display	14
TV connection	15
Connecting an external source	15

3 Using your Portable DVD Player

Charging the internal battery	18
Getting started	18
Standby mode	18
Volume controls	18
Stopping a DVD/CD	18
Play/ Pause DVD/CD	18
Skip chapter (DVD) or track (CD)	19
Search forward or backward	19
Display (DVD/CD)	19
Menu (DVD)	19
Title (DVD)	19
Repeat (DVD/CD)	19

3 Using your Portable DVD Player

Multi-angle (DVD)	19
Mute (DVD, CD)	19
Audio tracks (DVD)	20
Subtitles (DVD)	20
Zoom (DVD, Picture disc)	20
DVD, USB & SD input modes	20
JPG picture viewer	20
Program playback	21
GOTO function	21
Earphone usage	21

Setup menu

General	22
Audio (speaker setup)	22
Dolby (Audio output)	22
Video > Quality	23
Preferences	23

4 Other information

Technical specification	26
Care & maintenance	26

5 Product support

Troubleshooting	28
Help and assistance	29
Disposal	30
Guarantee	31

This page is left intentionally blank

Safety information

1

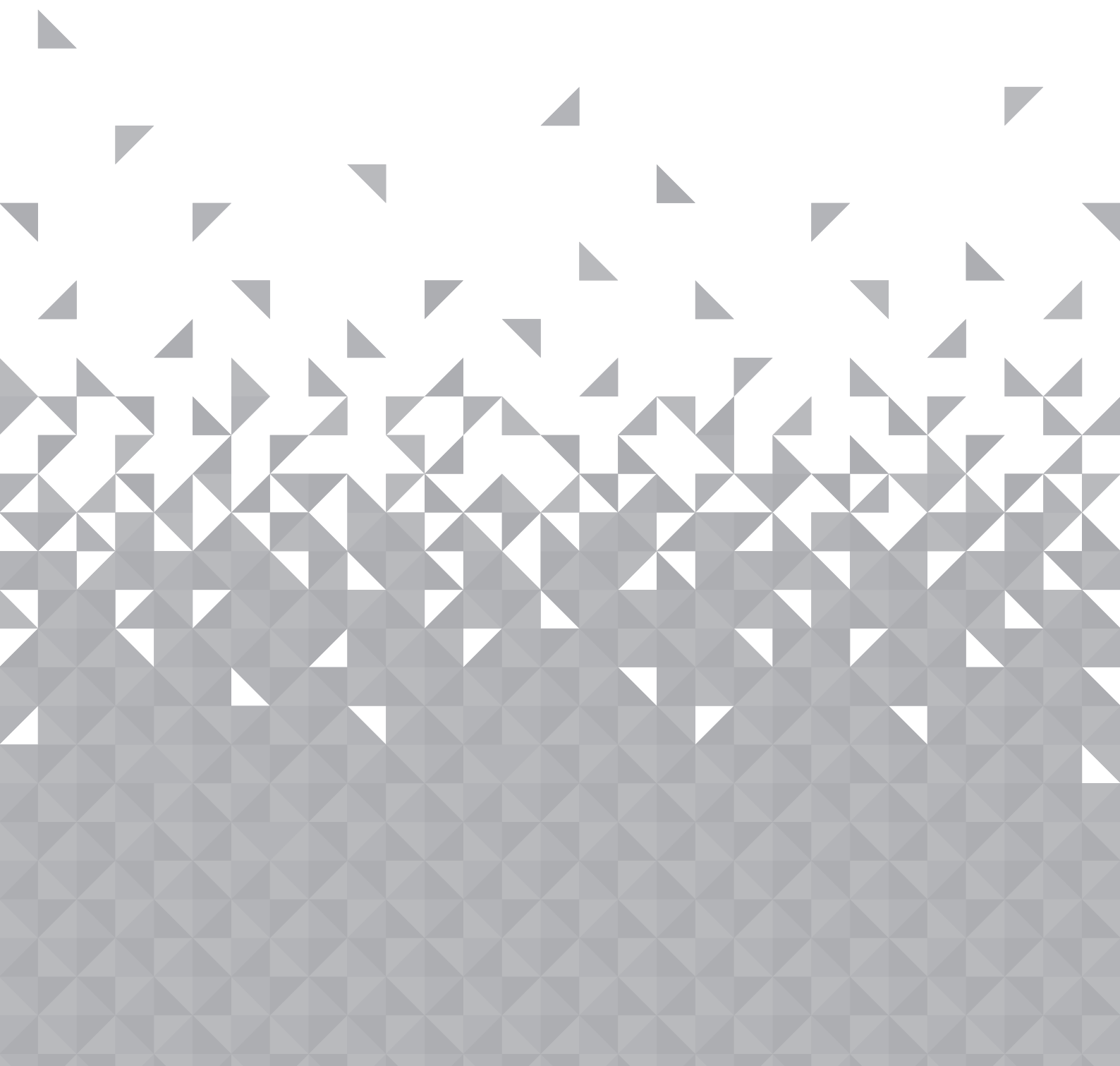



Safety information

Important - Please read these instructions fully before installing or operating

Power source



- This symbol means that this unit is double insulated. An earth connection is not required.
- The appliance must be connected to a 100-240 volt 50/60Hz AC supply by means of a three pin socket.
- Unplug this apparatus during lightning storms or when unused for long periods of time - to prevent damage to this product.



- Opening or removing covers may expose you to dangerous voltages or other hazards.



- To prevent risk of fire or electric shock, avoid overloading wall outlets, extension cords, or integral convenience receptacles.

- Use suitable power sources - Plug the product into a suitable power source, as described in the operating instructions or as marked on the product.

- The supply voltage should be the same as that indicated in the technical specifications and the appliance rating plate.

- If the socket outlets in your home are not suitable for the plug supplied with this unit check with a qualified electrician for replacement.

- In order to disconnect the apparatus from the mains completely, switch off the outlet and remove the mains plug completely.



- Do not bend, stretch or pull the supply cable in order to avoid electric shock.
- When installed, the power socket must be within easy reach.
- Do not install the unit in a confined space. Allow adequate ventilation to prevent heat build-up.
- For indoor use only.

Heat build up

- During use the unit will heat up, this is not a malfunction. If the unit is used continuously at high volume levels, the unit temperature will rise considerably. Do not touch the unit to avoid potential burns..

Moisture and water

- Do not use this apparatus near water or moisture.
- Do not use this product near a bathtub, washbowl, kitchen sink, and laundry tub, in a wet basement, near a swimming pool, or anywhere else that water or moisture is present.

Heat sources and flames



- Batteries shall not be exposed to excessive heat such as sun, fire or the like
- To prevent risk of fire or electric shock, avoid overloading wall outlets, extension cords, or integral convenience receptacles.

Servicing and repairs

- Refer all servicing to qualified service personnel
- Servicing is required when the apparatus has been damaged in any way: such as liquid has been spilled or objects have fallen into the apparatus; the apparatus has been exposed to rain or moisture, does not operate normally, or has been dropped.

If you require any technical guidance or find that your product is not operating as intended, a simple solution can often be found in the **Troubleshooting** section of these instructions,



Safety information

Important - Please read these instructions fully before installing or operating

Laser warnings



- This product utilizes a Class 1 laser.
- This laser CD Player is equipped with safety switches to avoid exposure when the door is open and the safety interlocks are defeated. Invisible laser radiation is present when the CD Player's drawer is open and the system's interlock has failed or been defeated. It is very important that you avoid direct exposure to the laser beam at all times. Please do not attempt to defeat or bypass the safety switches.
- This unit employs a laser, only qualified service personnel should attempt repair.

This page is left intentionally blank

Getting to know your Portable DVD Player

2

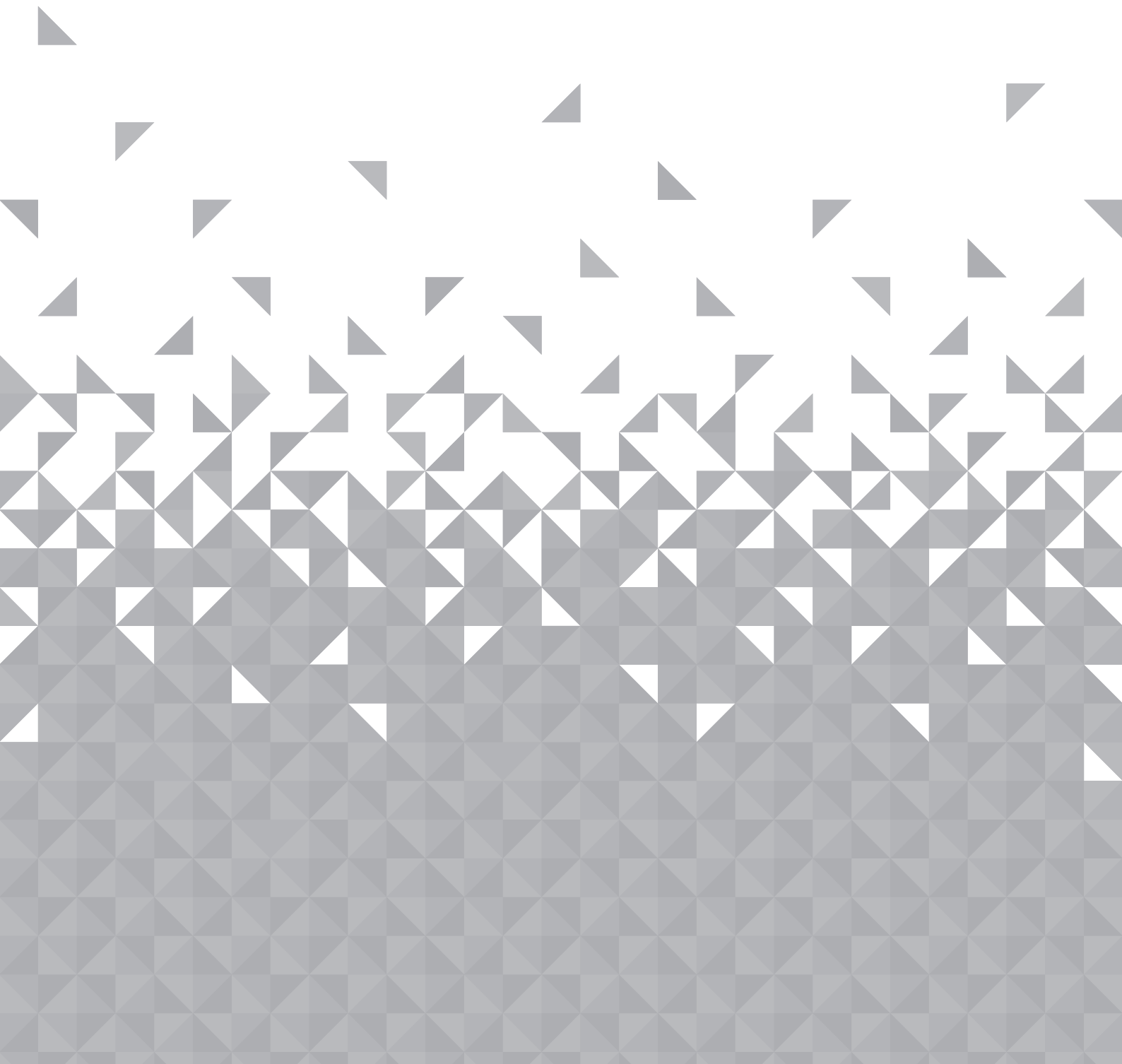

Getting to know your Portable DVD Player

You'll be up and running in no time

Ready? Let's begin...

Please read these instructions carefully. They contain important information which will help you get the best from your Portable DVD Player and ensure safe and correct installation and operation.

If you require any further assistance, our technical experts are happy to help. For full details, refer to the product support section at the end of these instructions.

Accessories

1. CDVD100W1SWM/P Portable DVD Player
2. Remote control
3. 2 x AAA batteries
4. Mains charger
5. In-car charger
6. AV cable
7. Earphones
8. Instruction manual

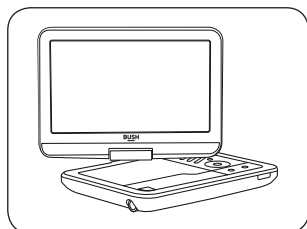

Portable DVD Player

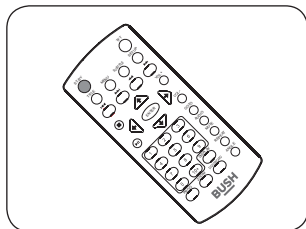

Remote control

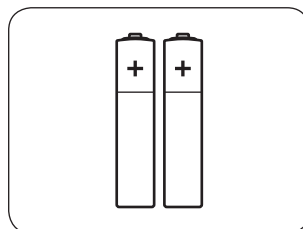

2 x AAA batteries

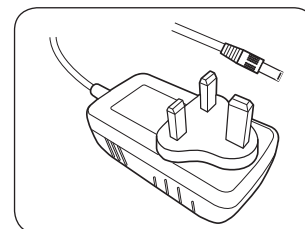

Mains charger

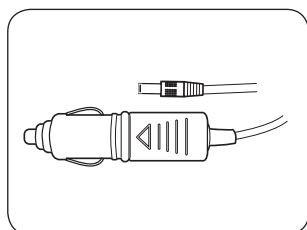

In-car charger

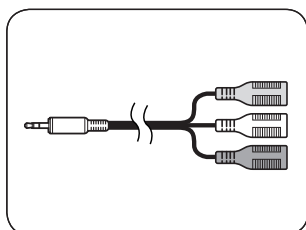

AV Cable

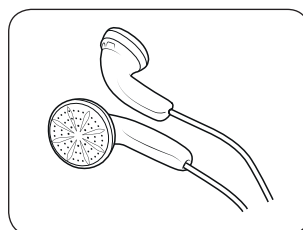

Earphones

If you require any technical guidance or find that your product is not operating as intended, a simple solution can often be found in the **Troubleshooting** section of these instructions.

Getting to know your Portable DVD Player

You'll be up and running in no time

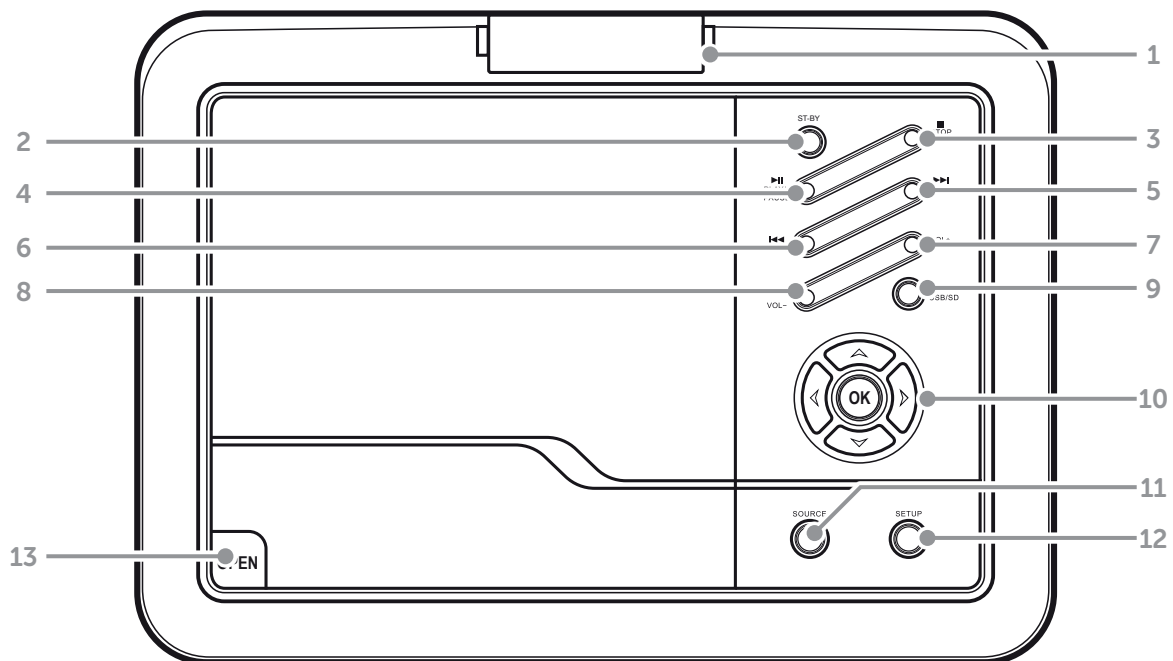

- 1. DISPLAY swivel**
- 2. STANDBY button:** Press to enter/wake from standby mode.
- 3. ■ STOP button:** Press to stop playback
- 4. ►|| PLAY/PAUSE button:** Press to begin playback or pause playback.
- 5. ►► SKIP button:** Press to skip next chapters.
- 6. ◀◀ SKIP button:** Press to skip previous chapters.
- 7. VOLUME+ button:** Increase volume level
- 8. VOLUME- button:** Decrease volume level.
- 9. DVD/USB/SD mode button:** Switch between input modes.
- 10. NAVIGATION/OK buttons:** Navigate & select menu's/setup functions.
- 11. SOURCE button:** Switch between internal player and external source.
- 12. SETUP button:** Press for setup menu
- 13. ▲ DISC TRAY EJECT button**

or online at www.argos-support.co.uk If you still require further assistance, call one of our experts on 0345 604 0105.

Getting to know your Portable DVD Player

You'll be up and running in no time

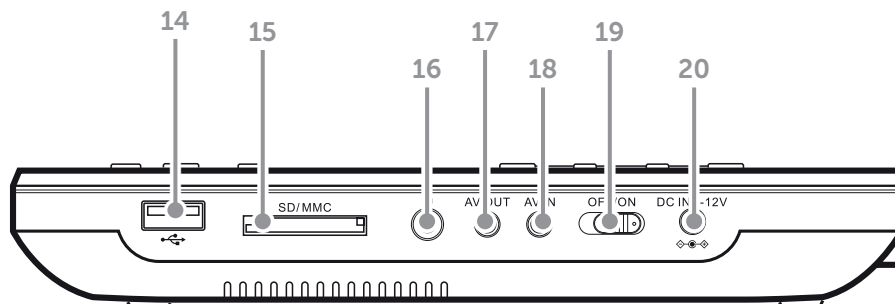

14. USB input socket: Connect a USB flash drive for photo viewing.

15. SD/MMC input socket: Insert an SD card for photo viewing.

16. HEADPHONE output socket: Connect headphones for private use. Insert a 3.5mm jack.

17. AV OUT socket: Connect an external viewing source such as a TV.

18. AV IN socket: Connect an external video source such as a full size Portable DVD Player.

19. ON/OFF switch: Power the Portable DVD Player on or off.

20. DC INPUT POWER socket: Connect the mains/ In-car charger supplied with the Portable DVD Player.

If you require any technical guidance or find that your product is not operating as intended, a simple solution can often be found in the **Troubleshooting** section of these instructions.

Getting to know your Portable DVD Player

You'll be up and running in no time

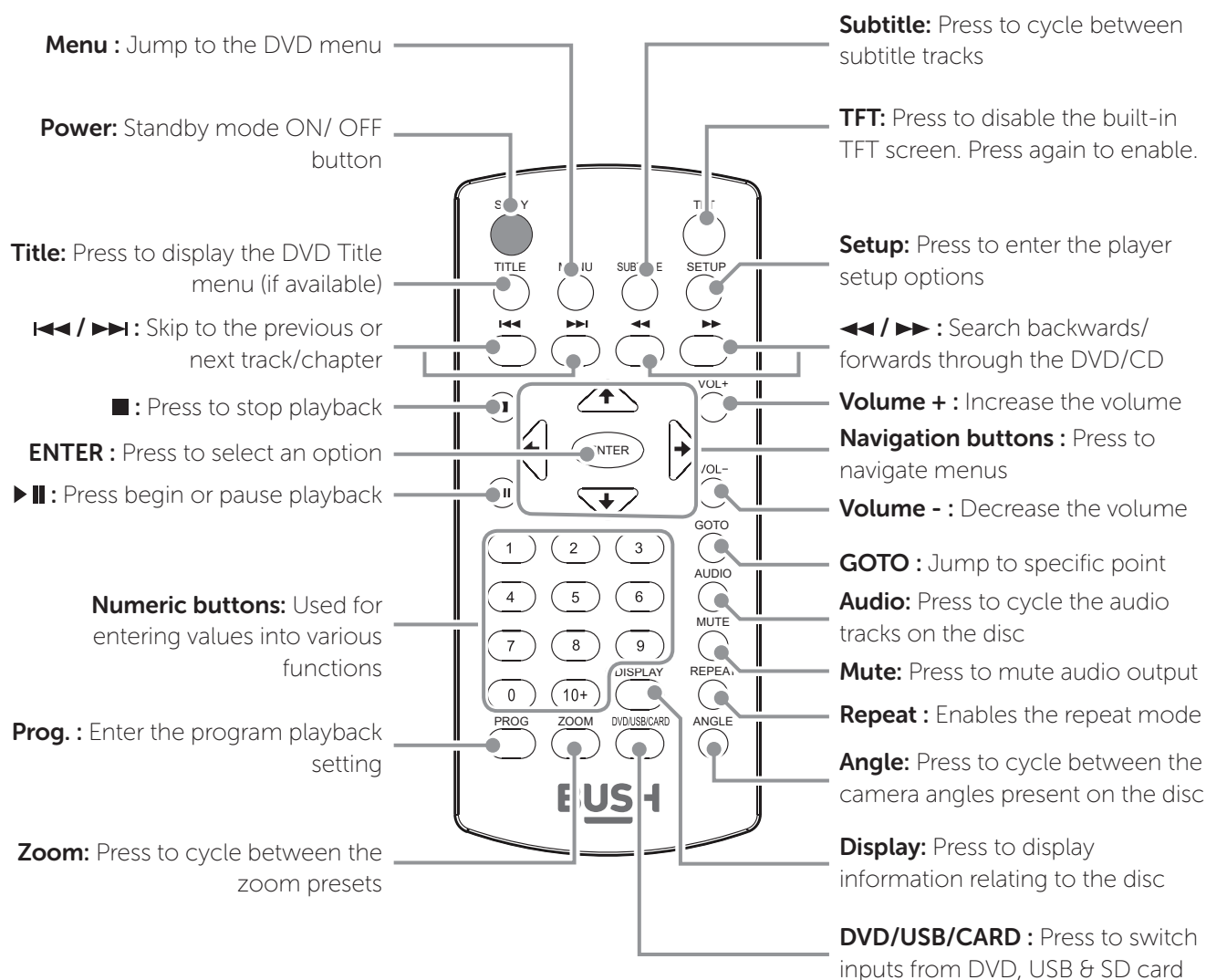

or online at www.argos-support.co.uk If you still require further assistance, call one of our experts on 0345 604 0105.

Getting to know your Portable DVD Player

You'll be up and running in no time

Installing the remote batteries

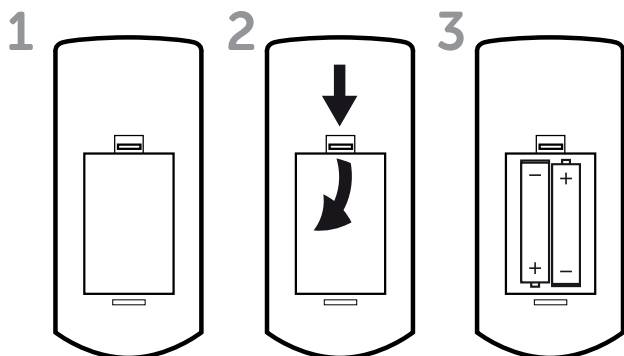

1. Remove the battery cover (as shown).
2. Insert 2 x AAA batteries, taking note that the polarities match up with the engraved diagrams inside the battery compartment.
3. Replace the battery cover.

Battery disposal advice

- Dispose of used batteries with regard to the recycling regulations in your area.
- Do NOT short circuit batteries or throw them into water, the general rubbish or in a fire. Weak batteries can leak and damage the remote control. Replace them in good time!

Powering with mains power

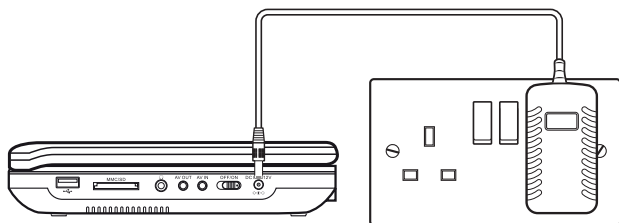

1. Insert the Mains adaptor jack into the DC INPUT socket (20) on the side of the portable DVD player.
2. Connect the mains adaptor plug to a wall outlet and power on.

Powering with the in-car power adaptor

If the unit requires charging or powering during vehicle travel you can use the supplied car power adaptor.

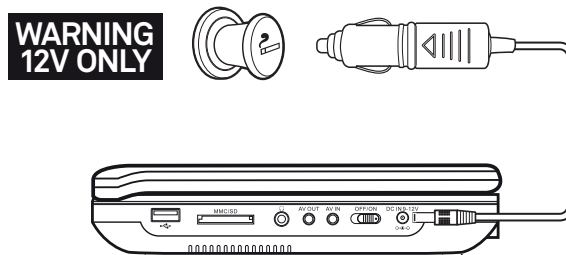

1. Ensure the POWER ON/OFF switch (19) is set to the OFF position.
2. Insert the small jack end of the car power adaptor into the DC input socket (20) on the side of the DVD player.
3. Insert the other end into a 12V car power adapter socket.



It is VERY important **not to connect** to a 24V car power adapter. Please check your vehicle manual before attempting.

4. Set the POWER ON/OFF switch (19) to the ON position to use the portable DVD player or follow the charging instructions on **page 18**.

Adjusting the swivel display

The display can be rotated a total of 270 degrees.

1. The display can be rotated 90 degrees Anti-clockwise from the facing front position.
2. The display can be rotated 180 degrees Clockwise from the facing front position.

Take care not to rotate any further than the specified angles, as internal wiring can be damaged.

Getting to know your Portable DVD Player

You'll be up and running in no time

TV connection

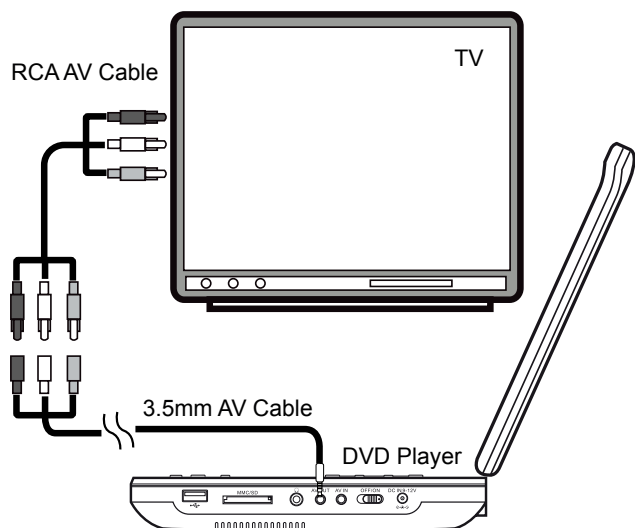

NOTE: before attempting to connect this unit to a TV, ensure that the portable DVD player and TV are both switched off.

1. Insert the 3.5mm end of the supplied AV adapter cable into the AV OUTPUT socket (17) on the side of the unit.
2. Connect the other ends of the adapter cable to an RCA AV cable (not supplied), as shown in the diagram.

Take note to match the colours when connecting.

3. Red & white sockets carry audio and can be connected to the TV inputs or to an external amplifier.
4. The yellow cable is the video cable and must be connected to the yellow video input on your TV.
5. After tuning your TV to the correct input the playing content of the portable DVD player will appear on the TV screen. To disable the output on the TFT screen of portable DVD player press the TFT ON/OFF button on the remote control.

Press the TFT ON/OFF button once more to enable once more.

Connecting an external source

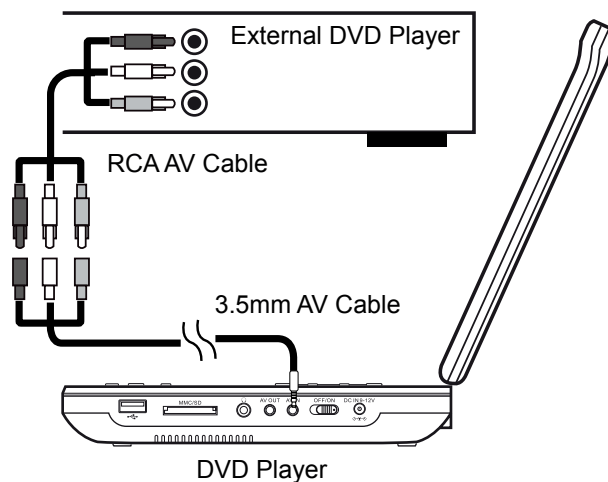

Connect an external source to the portable DVD player to allow playback on the integrated display.

1. Insert the 3.5mm end of the supplied AV adapter cable into the AV INPUT socket (18) on the side of the unit.
2. Connect the other ends of the adapter cable to an RCA AV cable (not supplied), as shown in the diagram.

Take note to match the colours when connecting.

3. Red & white sockets carry audio and must be connected to the AUDIO OUTPUT of the external source. The yellow cable is the video cable and must be connected to the yellow video output on the external source.
4. After making the connections you must press the SOURCE button on the Portable DVD player (11) to switch to the 'AV IN' mode.
5. Should you need to switch back to the internal DVD player, press the SOURCE button on the remote or main unit (11) again.

If your video source only has a SCART output, you can purchase a SCART adaptor; and connect the three coloured jacks to the same coloured sockets on the adaptor.

Then connect the adaptor to your video source.

This page is left intentionally blank

Using your Portable DVD Player

3

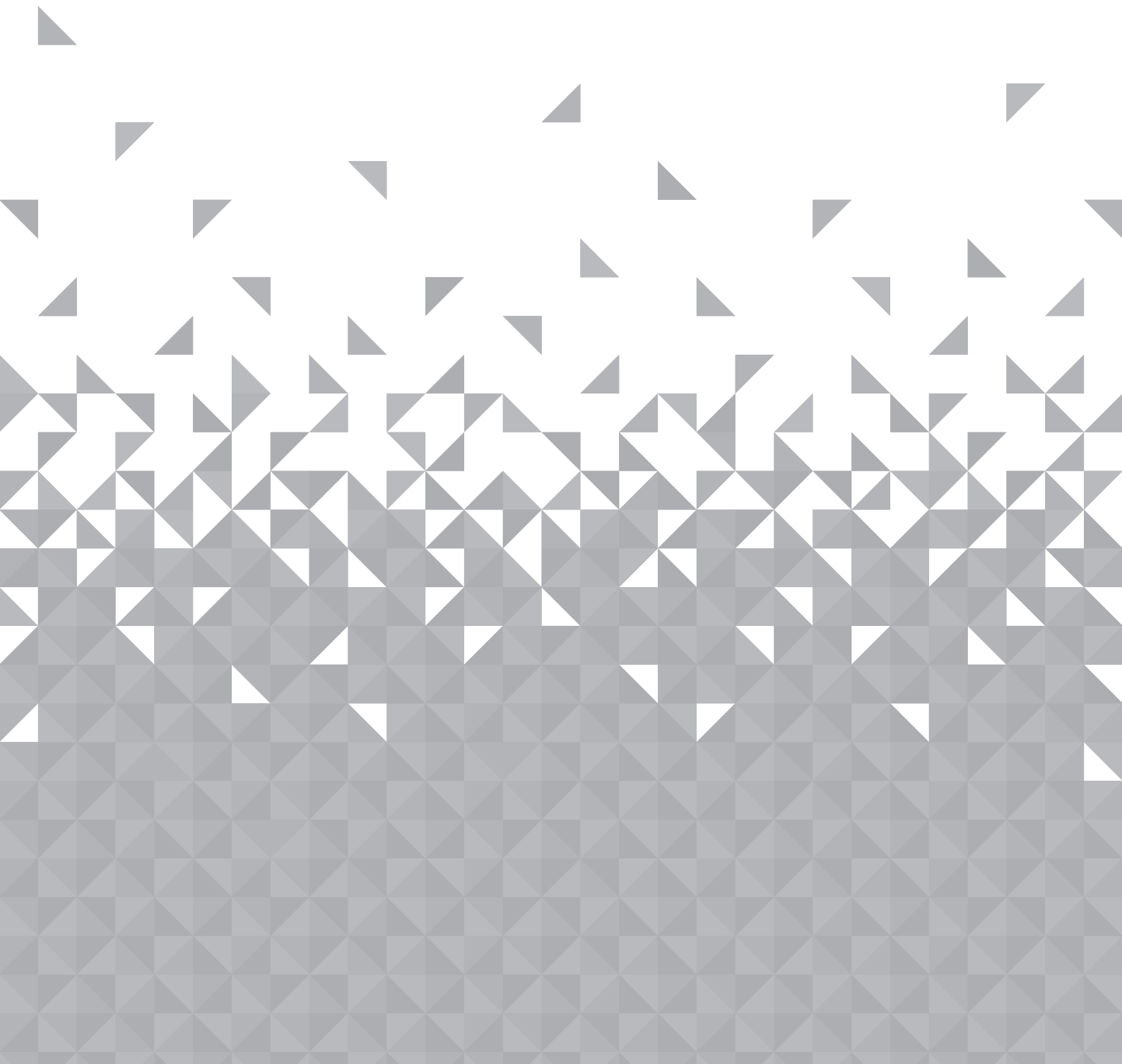

Using your Portable DVD Player

Let's get started

Charging the internal battery

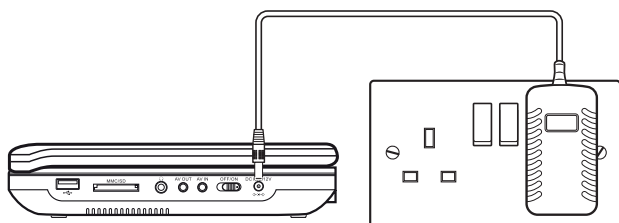

Before using the battery, please make sure it is fully charged.

1. Insert the Mains adaptor jack into the DC INPUT socket (20) on the side of the portable DVD player.
2. Connect the mains adaptor plug to a wall outlet and power on.
3. Slide the POWER switch (19) to the OFF position. When the battery is fully charged the red LED charging indicator will go off.

Approx 6 hours charge, and 3 hours usage

If the unit is not in use for a prolonged period of time, it is recommended to charge the built-in battery every three months.

Getting started

1. Slide the POWER switch (19) to the ON position (the green power LED will illuminate).
2. Press the disc compartment eject button (13) to open the disc tray.
3. Place a DVD disc onto the disc tray (label facing upwards).
4. Close the disc tray and the playback starts automatically.
5. When a menu screen appears on the screen, use the navigation buttons (10 or remote) to select the menu option you require, then press the OK/ENTER button (10 or remote) to start playback.

Standby mode

In order to save battery power, when not in use the player can be put into standby mode.

1. Press the STANDBY button on the main unit (2) or remote control to wake the unit from STANDBY mode.
2. Press the STANDBY button once more to enter STANDBY mode.

The portable DVD player will enter standby mode after 20 minutes of inactivity.

To wake the player from standby mode press the STANDBY button on the remote control or unit.

Volume controls

1. Use the VOLUME - / + buttons (7, 8) on the portable DVD player or remote to increase or decrease the listening level.

Stopping a DVD/CD

1. Pressing the ■ STOP button (3 or remote) once during playback will stop play at the current position.
2. Pressing the ►|| PLAY/PAUSE button (4 or remote) at this point will resume playback from the position you stopped playback from.
3. If you press the ■ STOP button (3 or remote) twice, playback will cease and the resume option will not be available.

Play/Pause DVD/CD

1. If you need to pause the playback at any time, press the ►|| PLAY/PAUSE button (4 or remote).
2. To resume playback press the ►|| PLAY/PAUSE button (4 or remote) again.

If you require any technical guidance or find that your product is not operating as intended, a simple solution can often be found in the **Troubleshooting** section of these instructions,

Using your Portable DVD Player

Let's get started

Skip chapter (DVD) or track (CD)

1. Press either **◀◀** or **▶▶** buttons (5,6 or remote) during playback to skip a chapter (DVD) or a track (CD) ahead or backwards.

This function may not work during the "Warning" section of a DVD.

Search forward or backward

1. During playback, press either **◀◀** or **▶▶** buttons (remote only) to fast search forwards or backwards.
2. Each press increases the search speed from 2X, 4X, 8X 16X & 32X the next press of the button will resume normal playback.

This function may not work during the "Warning" section of a DVD.

Display (DVD/CD)

1. When playing a disc, pressing the DISPLAY button (remote) will display various information about the playing disc. You will need to press the DISPLAY button four times to view all the info another press will hide the display info. **(Fig 1)**



Fig 1.

Different types of disc will show different options.

Menu (DVD)

1. Pressing the MENU button (remote) during playback displays the disc main menu.

Title (DVD)

1. Pressing the TITLE button (remote) during playback displays the discs title menu (if available).

The TITLE menu is the beginning track of a disc. (not all discs contain these and as such the TITLE button may not respond).

Repeat (DVD/CD)

The repeat function allows you to view a section of a disc repeatedly.

1. Press the REPEAT button (remote) once during playback to activate the REPEAT function.
2. Press repeatedly to cycle the REPEAT modes available for the current disc type.
3. Press the REPEAT button until you reach OFF to disable the REPEAT mode.

Some discs may not allow repeat functions.

Multi-angle (DVD)

Some disc contain scenes which have been shot simultaneously from a number of different angles. For these discs, the same scene can be viewed from each of these angles by using the ANGLE button.

1. During playback, pressing the ANGLE button (remote) will cycle through the available angles (if any exist).

A single DVD disc can contain up to 9 different viewing angles.

Mute (DVD, CD)

This function will instantly silence the audio.

1. Press the MUTE button (remote) to silence the audio.
2. Press the MUTE button again to resume.

Using your Portable DVD Player

Let's get started

Audio tracks (DVD)

It is common for a DVD disc to contain more than one audio track for example 5.1 audio, stereo audio and other languages.

1. Press the AUDIO button (remote) to cycle through the tracks.

This Portable DVD Player does NOT support DTS audio. If you select a DTS audio track or one is selected automatically no sound will be output. Should this occur select a compatible audio track.

Subtitles (DVD)

Many DVD discs contain subtitle tracks to aid in various ways.

1. Press the SUBTITLE button (remote) to activate the first set of subtitles.
2. Press the SUBTITLE button repeatedly to cycle through the available subtitle options.
3. Press the SUBTITLE button repeatedly until you reach OFF to disable the subtitle function.

Zoom (DVD, Picture disc)

To zoom into the displayed image follow the below steps.

1. Press the ZOOM button (remote) to activate the zoom setting of 2X. Every subsequent press cycles through the zoom options eg: 3X, 4X, 1/2, 1/3 & 1/4. The next press will return to the OFF setting.
2. When in ZOOM mode you can use the navigation buttons on the remote to scroll the picture up, down, left & right.

Zooming into the picture will degrade the quality of the viewed image as the pixels are being stretched.

DVD, USB & SD Input modes

Press the DVD/USB/SD(CARD) button (6 & remote) to switch between DISC playback, USB & SD card photo viewer modes.

JPG picture viewer

JPEG picture discs can be obtained from any good photo developing lab, created manually on a computer or you can load jpg images onto a USB flash drive.

1. Insert a disc, USB flash drive or SD card containing JPG pictures into the USB slot (14) or SD slot (15).
2. If the files are on a disc the file browser menu will be displayed. If the files are located on a USB flash drive or SD card you will need to press the DVD/USB/SD(CARD) button to switch to USB or SD card mode.
3. Use the navigation (▲▼◀▶) buttons to navigate the list of pictures & press the OK button to begin a slide show of the folder.



4. Press the MENU button (remote) to return to the file browser screen.
5. Press the ■ STOP button (3 & remote) during a slideshow to display a thumbnail view of the selected folder.
6. To display an image indefinitely press the ►|| PLAY/PAUSE button (4 & remote). To resume the slide show press the ►|| PLAY/PAUSE button once again.
7. During the slide show the navigation buttons will rotate the displayed image.
8. Press the ◀◀ / ▶▶ buttons (5, 6 & remote) to skip to the previous or next image.
9. Press the ZOOM button (remote) to activate the default zoom setting of 100%. Every subsequent press cycles through the zoom options eg: 100%, 125%, 150%, 200%, 75% & 50%.
10. Repeat can be set to SINGLE, REP ONE, REP FOLDER or FOLDER by repeatedly pressing the REPEAT button (remote).

If you require any technical guidance or find that your product is not operating as intended, a simple solution can often be found in the **Troubleshooting** section of these instructions.

Using your Portable DVD Player

Let's get started

Program playback

1. Press the PROG button to begin the program function.

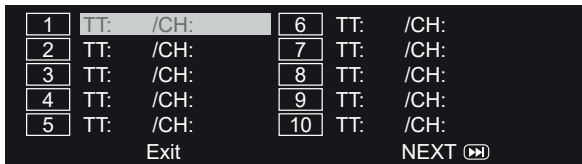

2. Use the navigation buttons to highlight program order number.
3. Enter the TITLE/CHAPTER or TRACK number
EG:- Title/Chapter /Track 22 would mean pressing the '10+' button twice and then the '2' button.
4. Repeat steps 2-3 until you have programmed all the chapters/tracks required. Should you require more Title/Chapters or Tracks than 10, navigate to the NEXT icon and press the OK/ENTER button. Tracks 11-20 will now be programmable.
5. Once the programming is complete navigate to the START icon and press the OK/ENTER button to begin playback of your programmed sequence.

GOTO function

The GOTO function allows you to enter a specific chapter, title, audio track, subtitle track, angle and specific time codes.

1. Press the GOTO button (remote) during playback to activate the GOTO menu screen.
2. Press the GOTO button to cycle through the GOTO options.
3. Use the numeric buttons to enter the chapter, track or time you wish to skip to..

Earphone usage

1. Connect earphones to the 3.5mm output on the side of the main unit (16).



- Listen at moderate volumes to avoid hearing damage.
- If you hear no sound during playing, do not turn up volume up as the music may suddenly begin at a high volume.
- Excessive sound pressure from earphones and headphones can cause hearing loss.
- To avoid damaging your ears, adjust the volume to the lowest safe level before playing, and turn up to the desired level when playback has started.

Using your Portable DVD Player

Let's get started

Setup menu

The setup menu contains various preferences for functions found on the unit. To enter the Setup menu press the SETUP button on the remote control.

General	Audio	Dolby	Video	Preference
- - General Setup Page - -				
TV Display	Wide			
Angle mark	On			
OSD Lang	ENG			
Screen Saver	On			
Last Memory	Off			
Go To General Setup Page				

Use the ▲▼◀▶ buttons to scroll; press the OK/ENTER button to select.

General

TV display

Choose a setting between:-

- Normal 4:3/PS (pan and scan)
- Normal 4:3/LB (letter box)
- Wide (widescreen).
- Wide squeeze

Angle mark

Enabling this function displays an icon for a compatible disc when multiple angles are available for selection.

OSD lang

This option sets the On Screen Display language. Choose between:-

- English
- Spanish
- French

Screen saver

When the unit is not in use, the DVD logo will appear as a screen saver to prevent screen burn in. Choose ON or OFF.

Last memory

When set to ON the unit will remember the last position on a disc before the unit was shut down (STANDBY).

Audio (speaker setup)

Downmix

This option allows you to change the way the audio is assigned to each speaker. Choose from:-

- LT/RT - Left / Right mixed mode
- STEREO - Stereo audio output

Dolby (Audio output)

DUAL MONO: Only applies to discs with Dolby Digital 5.1

- STEREO: The audio frequency on the Left & Right channels will be output respectively from the Left & Right speakers.
- LEFT-MONO: The audio frequency on the Left & Right channels will be output only from the Left speaker.
- RIGHT-MONO: The audio frequency on the Left & Right channels will be output only from the Right speaker.
- MIX-MONO: The audio frequency on the Left & Right channels will be merged together and output from both Left & Right speakers.

Dynamic

When watching a disc with high dynamic audio at low volumes you can increase the dynamic range to reduce the loss of sound details.

If you require any technical guidance or find that your product is not operating as intended, a simple solution can often be found in the **Troubleshooting** section of these instructions.

Using your Portable DVD Player

Let's get started

Video > Quality

Sharpness

Set the video sharpness level. Select from:-

- Low
- Medium
- High

Brightness

Set the video brightness level. Use the ◀/▶ buttons to increase or decrease from -20 to +20. Press the OK/ENTER button to complete the setting.

Contrast

Set the video contrast level. Use the ◀/▶ buttons to increase or decrease from -16 to +16. Press the OK/ENTER button to complete the setting.

Preferences

Available only when no disc is loaded

TV type

Set this option to whatever type of disc you are watching. NTSC, PAL or MULTI (to set automatically).

Audio

Choose the default audio setting. This means the Portable DVD Player will automatically select this language as the audio track (if available).

Subtitle

Select the default subtitle language.

Disc menu

This option sets the default DVD menu language. Once set if the DVD you are watching contains a menu with your specified language that is used by default.

Parental

Choose between:-

- Kid Safe
- G
- PG
- PG13
- PG-R
- R
- NC-17
- Adult

When changing the parental level you will be asked to enter the password. The default password is '1234'.

Password

1. Enter a new password. First you will be required to enter the current password. This will be '1234' if changing for the first time.
2. Once you have entered a correct existing password you can then enter your new password and confirm. Press the OK/ENTER button to save the new password.

The master override password can be used if you change the default but forget the new password. The master password is '1369'.

Default

Activating this option resets every setting to the factory default.

This page is left intentionally blank

Other information 4

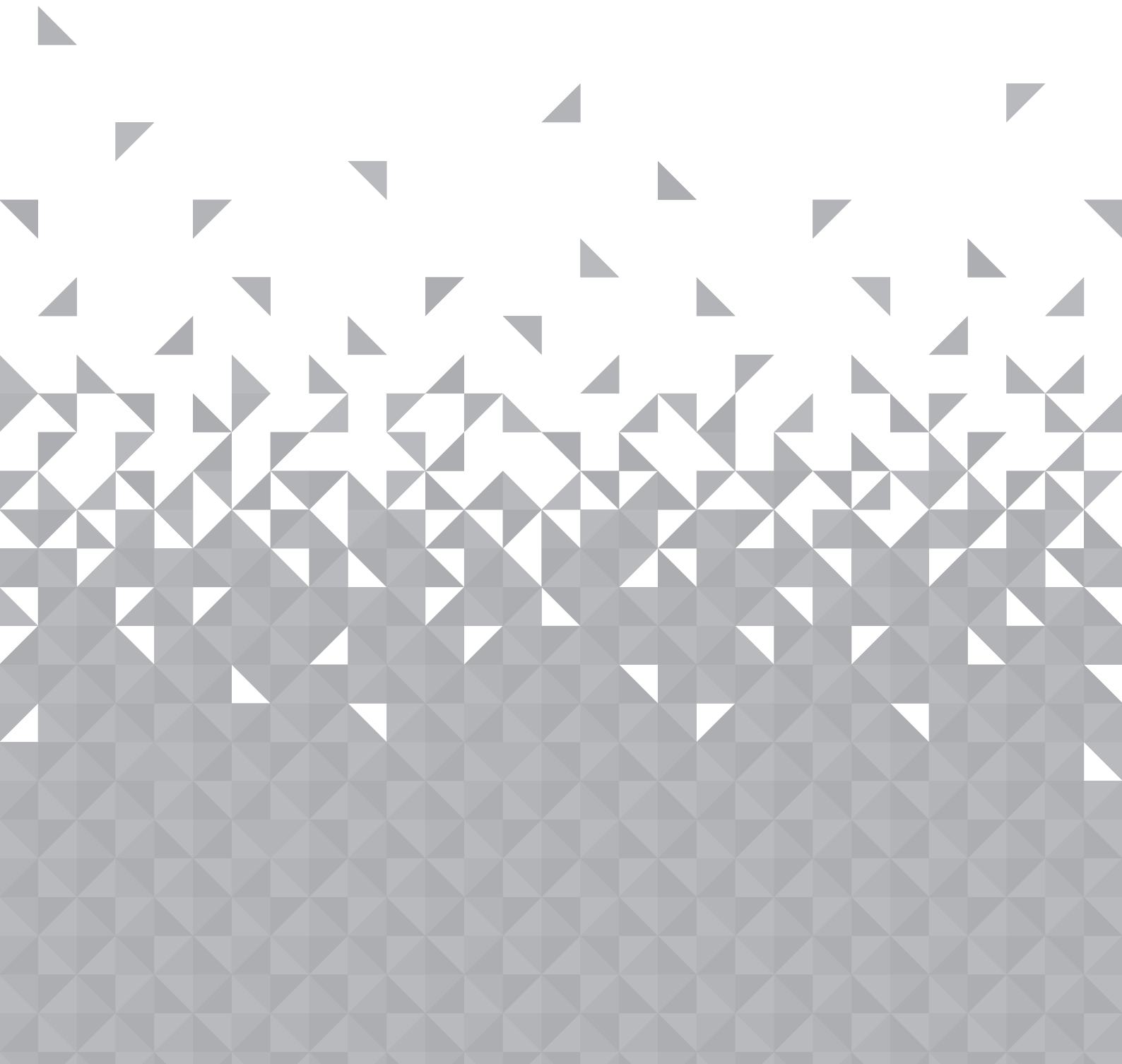

Other information

Helpful technical information

Technical specification

Portable DVD Player

Power	Supply: DC 9V 1500mA Input: 100-240V ~ 50/60Hz 0.3A
Input voltage	DC 9 - 12V
Battery	Lithium battery
Battery capacity	1800 mAh 7.4V
Dynamic range	≥85dB
Video output	1Vp-p 75Ω unbalanced
Frequency response	20Hz~20KHz
Screen size	10" (25.4cm)
Supported formats	CD, JPG, PICTURE CD - CD-R, DVD, DVD-R, DVD+R
Supported memory formats	USB, SD (SD up to 16Gb SDHC)
Remote control	
Battery	2 x AAA

Care & maintenance

After using the Portable DVD Player

Set to Standby.

Switch the unit off at the mains and unplug it if you are leaving it unattended for a long period (holidays etc).

Avoid leaving the batteries fitted in the remote control if you leave the unit unattended for long periods. They may leak and damage the remote control.

Care & cleaning

All care and cleaning operations should be carried out with the unit unplugged from the mains power.

Occasionally wipe the cabinet with a lint free duster. Never clean the unit with liquids or solvents.

If you require any technical guidance or find that your product is not operating as intended, a simple solution can often be found in the **Troubleshooting** section of these instructions.

Product support 5

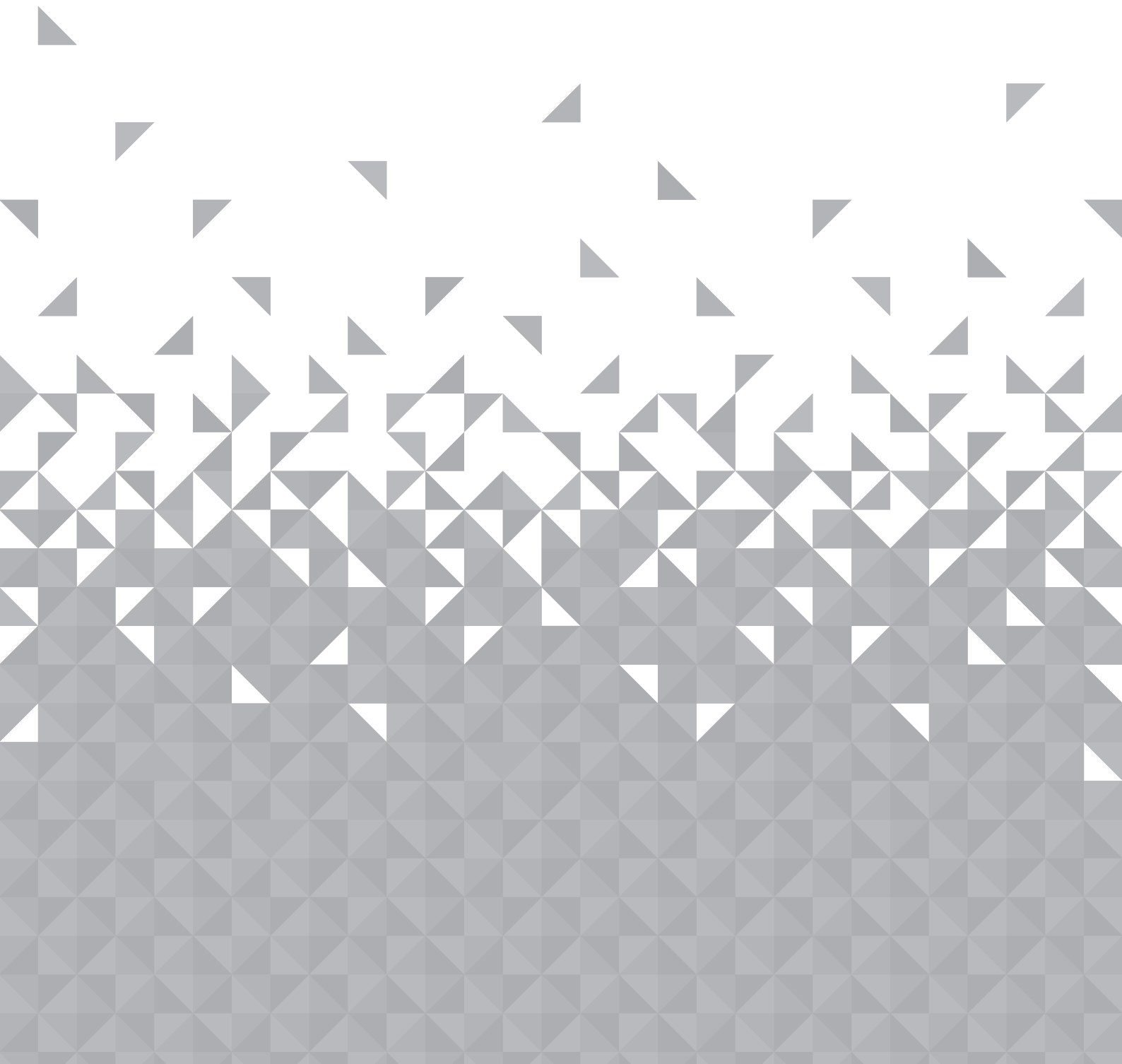

Product support

Help is always at hand

Troubleshooting

No power.

- The internal battery is flat. Re-charge the battery.
- Ensure the mains adaptor is connected to a power supply & the portable DVD player, and is switched ON.
- Make sure there is power to the mains socket.

No picture?

- The TFT button has been pressed disabling the image on the internal display. Press the TFT button to enable the internal display once more.
- Incorrect connections made if using external source or TV. Re-check the connections.

No sound?

- The volume level is too low. Increase the volume.
- Non compatible DTS audio track selected. Choose another audio track as this Portable DVD Player does not support DTS audio.

Distorted picture

- The disc may be dirty. Clean the disc and try again
- The fast forward or rewind mode may be active. Picture distortion in this mode is normal.

Unable to play

- There is no disc in the tray.
- The disc is not loaded properly. Press the disc compartment eject button and re-seat the disc.
- The disc may be dirty. Clean the disc and try again
- The setup menu is obscuring the picture. Press the SETUP button to close the menu

The remote control is not working

- The batteries may be low on power. Replace with new batteries.
- There may be an object obscuring the path to the DVD IR sensor.
- The remote control may be too far away from the IR sensor to work.

Forgotten your pass code.

- The default override pass code is '1369'

If you require any technical guidance or find that your product is not operating as intended, a simple solution can often be found in the **Troubleshooting** section of these instructions,

Product support

Help is always at hand

Help and assistance

If you require any technical guidance or find that your Portable DVD Player is not operating as intended, a simple solution can often be found in the **Troubleshooting** section of these instructions or online at www.argos-support.co.uk

If you still require further assistance, call one of our experts on **0345 604 0105***. To help give us give you a fast and efficient service please have the following information ready:

Model Ref.	<input type="text" value="CDVD100W1SWM/P"/>	You can find these on the rating plate - a small information panel (usually a sticker or metal plate) on the rear of your product
Serial number	<input type="text"/>	
Date of purchase	<input type="text"/>	This will be shown on your receipt

Local call rates applies*

Lines open 8am-7pm Monday to Saturday and 10am-4pm Sunday.

*Calls to Argos enquiry lines may attract a charge and set up fee from residential lines depending on your call plan/tariff. Mobile and other providers costs may vary, see www.bt.com/pricing for details.

For Security and training purposes, telephone calls to and from customer service centres maybe recorded and monitored. Calls from Republic of Ireland will attract international call charges.

or online at www.argos-support.co.uk If you still require further assistance, call one of our experts on **0345 604 0105**.

Product support

Help is always at hand

Disposal



- Disposal of your old product. Your product is designed and manufactured with high quality materials and components, which can be recycled and reused
- When this crossed out wheeled bin symbol is attached to a product it means the product is covered by the European Directive 2002/96/EC.
- Please make yourself aware of the local collection system for electrical and electronic products.
- Please act according to your local rules and do not dispose of your old products with your normal household waste.
- The correct disposal of your old product will help prevent potential negative consequences for the environment and human health.

CE This product is intended for use within the UK. This equipment complies with the essential requirements for the Radio Equipment and Telecommunications Terminal Equipment Directive 1999/5/EC.

This appliance complies with the following EEC directives: 2014/35/EU Low voltage directive / 2014/30/EU EMC directive

Product support

Help is always at hand



Call us now and activate your 12 month guarantee

Thank you for choosing Bush. Your new product is guaranteed against faults and breakdowns for 12 months. Don't forget to register it with us today so we can provide you with our best possible after-sales service and useful updates.

www.bushregistration.co.uk

FREEPHONE*

0800 597 8548

Lines are open 8am - 8pm, 365 days a year. *Calls may be recorded and monitored.

Your Bush Guarantee

This product is guaranteed for twelve months from the date of original purchase. Any defect that arises due to faulty materials or workmanship will be repaired free of charge (or if applicable the product will be replaced or the purchase price refunded) where possible during this period by the dealer from who your purchased the unit.

The guarantee is subject to the following provisions:

- The guarantee does not cover accidental damage, misuse, cabinet parts, knobs or consumable items.
- The product must be correctly installed and operated in accordance with the instructions contained in the manual.
- It must be used solely for domestic purposes. The guarantee will be rendered invalid if the product is re-sold or has been damaged by inexpert repair.
- Specifications are subject to change without notice.
- Bush disclaim any liability for loss or damage arising from the breakdown of the product.
- This guarantee is in addition to and does not diminish your statutory or legal rights.

Important Data Protection Information

If you provide us with information about another person, you confirm that they have appointed you to act for them, to consent to the processing of their personal data including sensitive personal data and that you have informed them of our identity and the purposes (as set out in the Important Data Privacy notice displayed overleaf) for which their personal data will be processed.

You are entitled to ask for a copy of the information we hold about you (for which we may charge a small fee) and to have any inaccuracies in your information corrected.

For quality control and training purposes, we may monitor or record your communications with us.

If your personal details change, if you change your mind about any of your marketing preferences or if you have any queries about how we use your information, please let us know by contacting our Data Protection Officer, Domestic & General, Leicester House 17 Leicester Street, Bedworth, Warwickshire CV12 8JP.

Guarantor: Argos Limited - 489 - 499 Avebury Blvd. - Milton Keynes - MK9 2NW

or online at www.argos-support.co.uk If you still require further assistance, call one of our experts on **0345 604 0105**.

BUSH

Contact:

www.argos-support.co.uk

Helpline: 0345 604 0105

