

# Newbury Double 2 Drawer Bed Frame

Assembly Instructions - Please keep for future reference

412/2018

625/6793



**Heart of House**

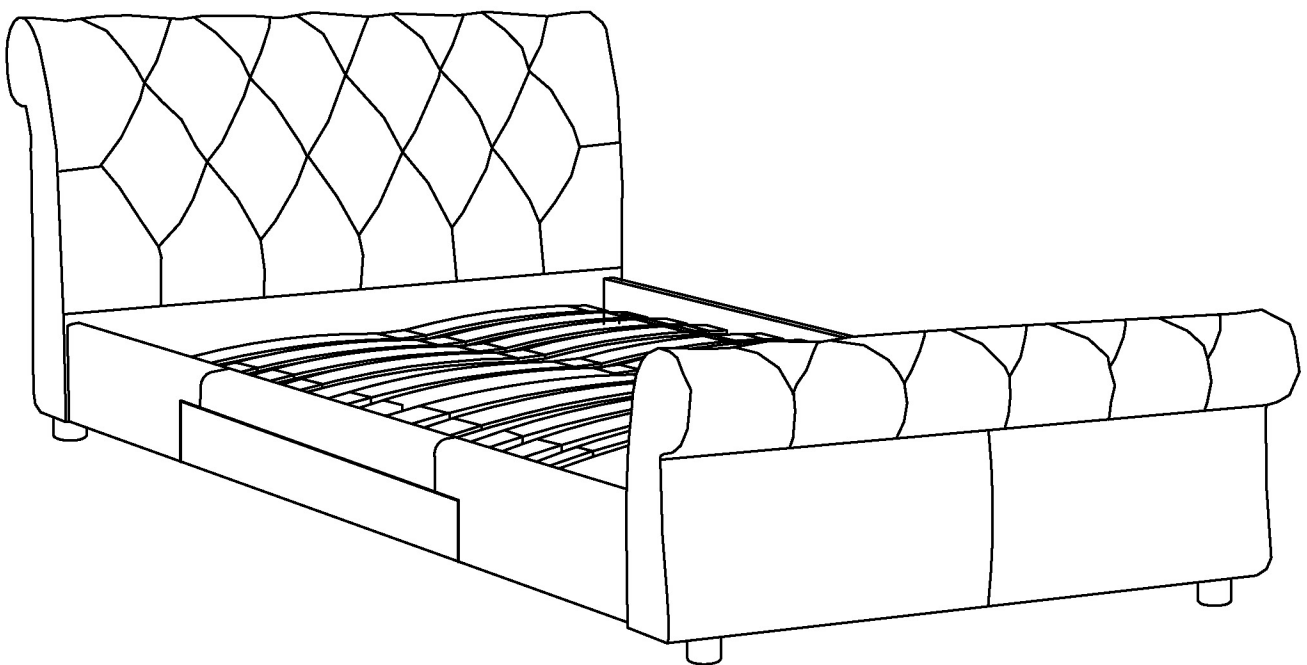

## Dimensions

Width x Depth x Height  
229cm x 150cm x 96cm (Double)

**Important - Please read these instructions fully before starting assembly**

If you need help or have damaged or missing parts, call the Customer Helpline:  
**Argos = 0345 6400800**



# Safety and Care Advice

**Important – Please read these instructions fully before starting assembly**

- Check you have all the components and tools listed on the following pages.
- Remove all fittings from the plastic bags and separate them into their groups.
- Keep children and animals away from the work area, small parts could choke if swallowed.
- Make sure you have enough space to layout the parts before starting.

- During assembly do not stand or put weight on the product, this could cause damage.
- Assemble the item as close to its final position (in the same room) as possible.
- Assemble on a soft level surface to avoid damaging the unit or your floor.
- Parts of the assembly will be easier with 2 people.



power drill is set on a low torque setting.

- To reduce the likelihood of damaging your product please ensure that your

## Care and maintenance

- Only clean using a damp cloth and mild detergent, do not use bleach or abrasive cleaners.
- From time to time check that there are no loose bolts or screws on this unit.
- This product should not be discarded with household waste. Take to your local authority waste disposal centre.

## Handy Hints

- Assemble all parts and bolts loosely during assembly, only once the product is complete should you fully tighten the bolts.
- Regularly check and ensure that all bolts and fittings are tightened properly.

**Note:** if required the next page can be cut out and used as reference throughout the assembly. Keep this page with these instructions for future reference.

# Components

If you need help or have damaged or missing parts, call the  
Customer Helpline: Argos = 0345 6400800

Please check you have all the parts listed below

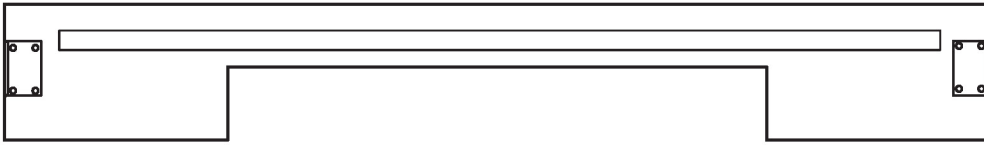

1 Right side rail

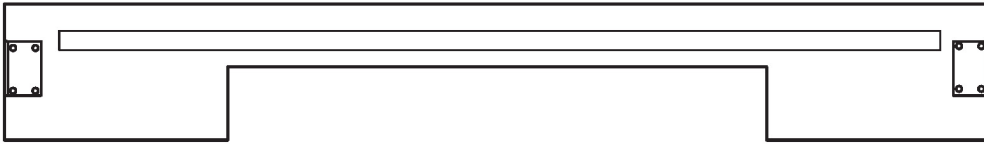

2 Left side rail

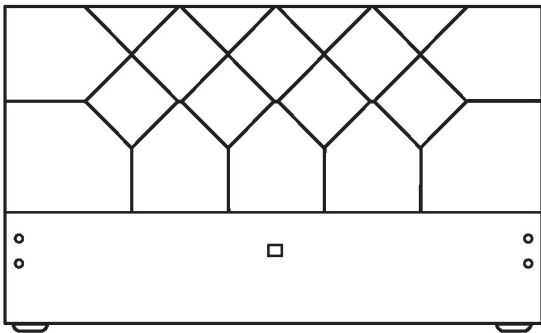

3 Headboard

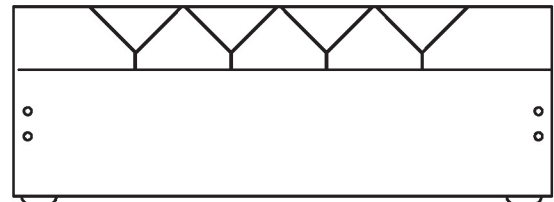

4 Footboard



5 Central support rail

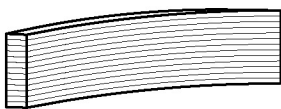

6 Slats x 2



7 Drawer front x 2

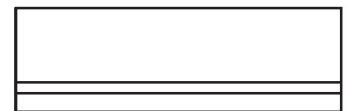

8 Drawer sides x 4

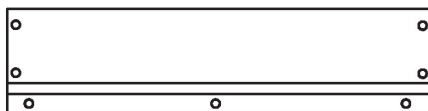

9 Drawer back x 2

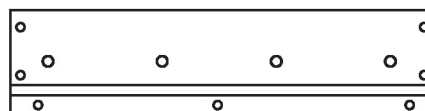

10 Inner drawer front x 2



13 Drawer base x 2



11 Drawer base support x 4













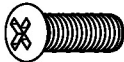

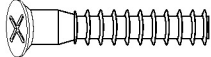
12 Drawer base center support x 2

# Components - Fittings

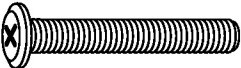
Please check you have all the fittings listed below

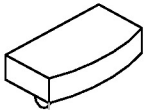
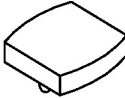
**Note:** The quantities below are the correct amount to complete the assembly. In some cases more fittings may be supplied than are required.

<p><b>A</b> </p> <p>M8 Bolts(40mm)x 2</p>	<p><b>B</b> </p> <p>M8 Bolts(18mm)x 8</p>	<p><b>C</b> </p> <p>M8 Bolts(20mm)x 4</p>
<p><b>D</b> </p> <p>M5 Allen key x 1 (supplied)</p>	<p><b>E</b> </p> <p>washers x 14</p>	<p><b>F</b> </p> <p>M7 Bolts x 16</p>
<p><b>G</b> </p> <p>Screws x 32</p>	<p><b>H</b> </p> <p>M8 Bolts (30mm) x 8</p>	<p><b>I</b> </p> <p>Nuts (M6) x 12</p>
<p><b>J</b> </p> <p>M6 Bolts(40mm)x12</p>	<p><b>K</b> </p> <p>Wheels x 8</p>	<p><b>L</b> </p> <p>Feetx 2</p>
<p><b>M</b> </p> <p>End slat caps x 26</p>	<p><b>N</b> </p> <p>Central slat caps x 13</p>	<p><b>O</b> </p> <p>Feet 4</p>

## Tools required

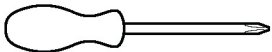

Phillips screwdriver

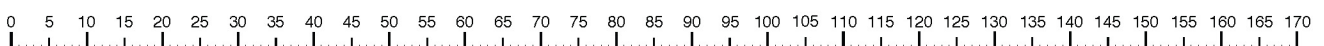

Ruler - Use this ruler to help correctly identify the screws



# Assembly Instructions

## Step 1

### Attaching feet

Attach 2 x feet  to the underside of the headboard .

Repeat on the underside of the footboard .

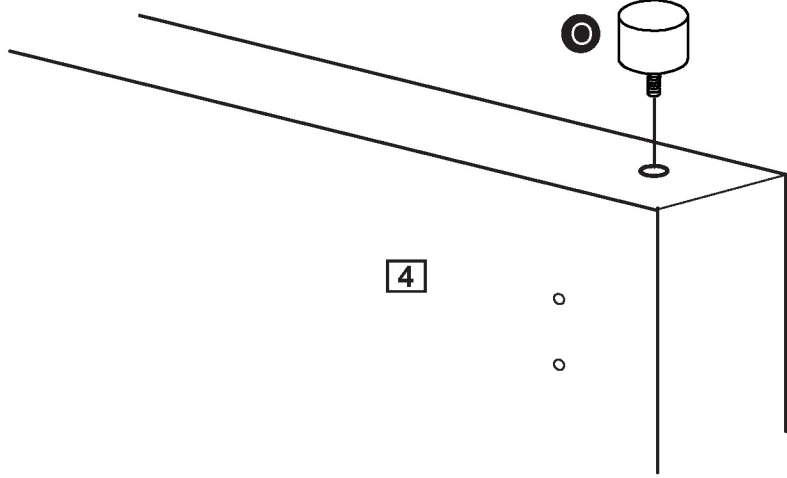
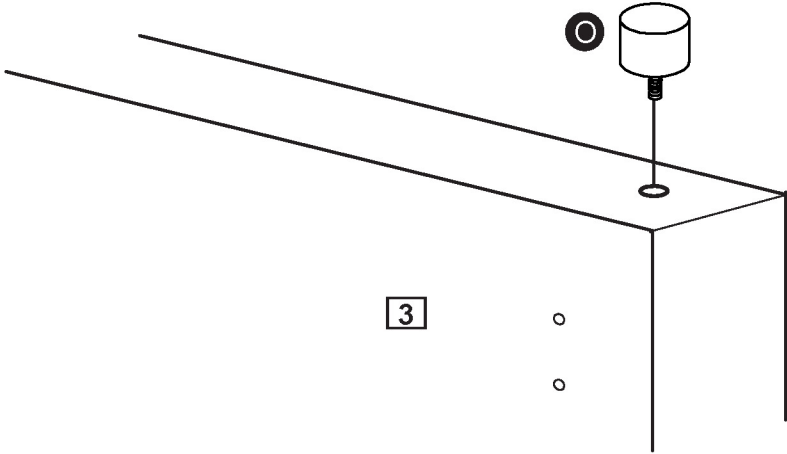

# Assembly Instructions

## Step 2

### Attaching side rails

a: Attach 2 bolts **B** to the headboard **3** and footboard **4** using the Allen key **D** provided.

a:

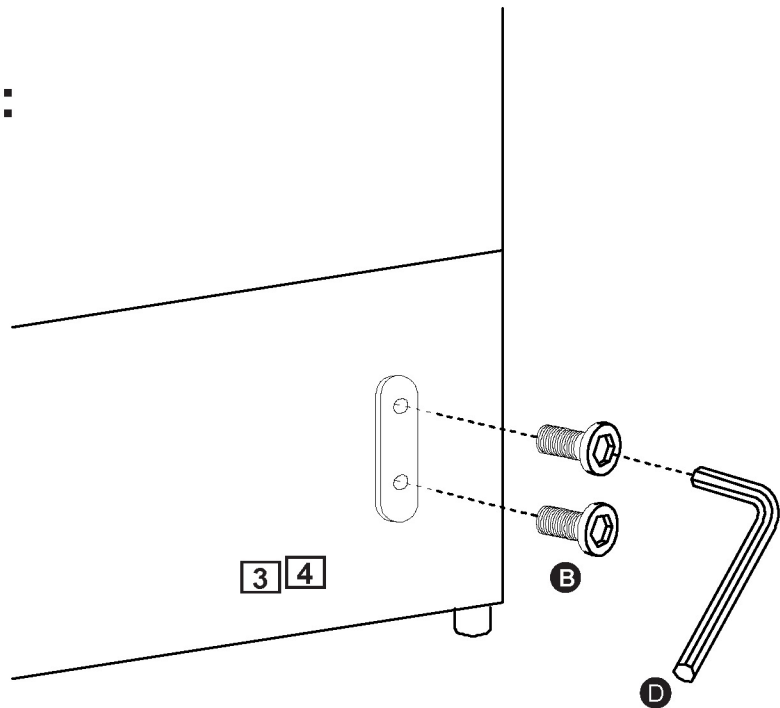

b: Position left side rail **2** adjacent to headboard **3** & **4** so that the holes in the headboard line up with the bracket on the side rail.

Secure in place by 2 bolts **B** using the Allen key provided.

Repeat b for right side rail **1**.

**Do not fully tighten at this stage.**

b:

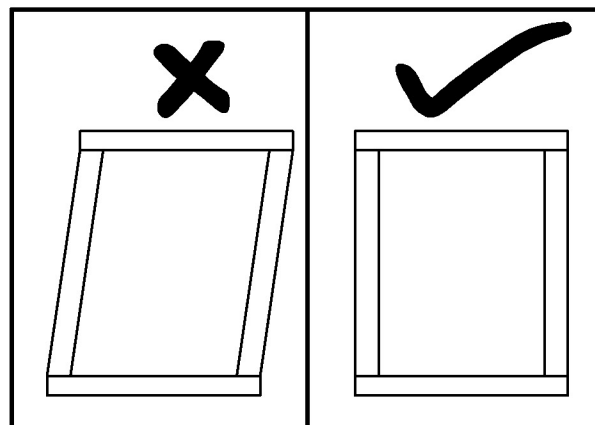
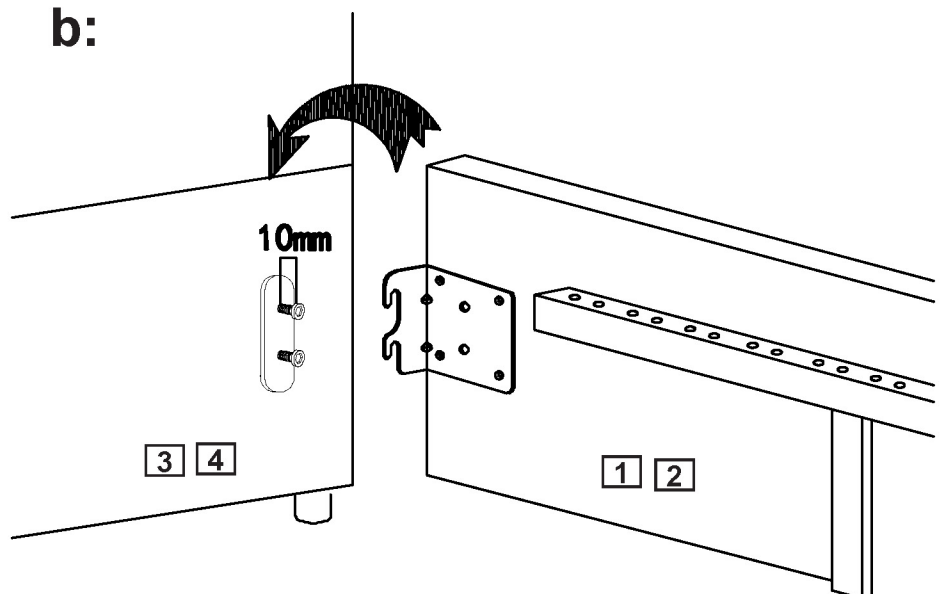

# Assembly Instructions

## Step 3

### Central support assembly

Insert the feet **L** into the holes on the central support rail **5** and secure using bolts **A** and washers **E**.

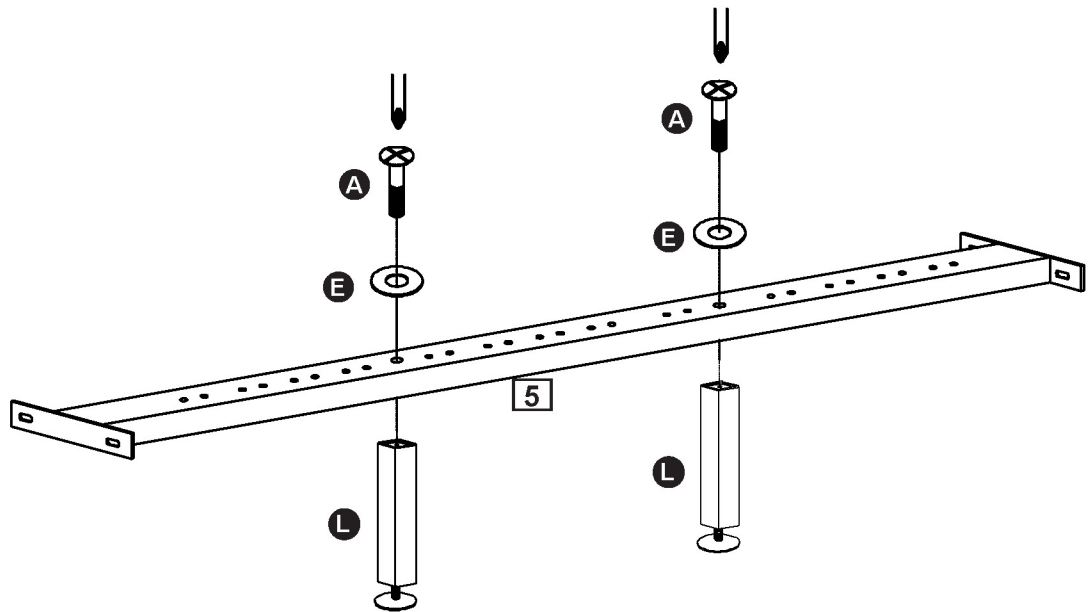

## Step 4

### Attach central support

Secure the central support rail **5** to the headboard **3** using bolt **C** and washer **E**.

Repeat at the footboard end.

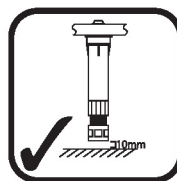
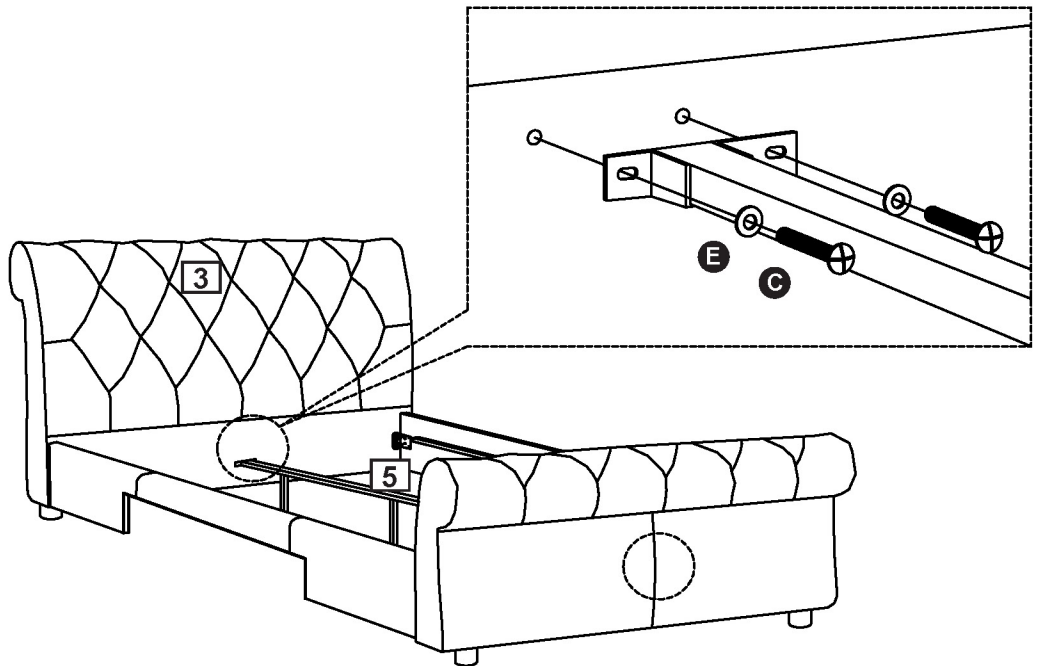

## Warning

adjust the feet so that they are not in contact with the floor when the mattress is in place. There should be a 10mm (1/2 inch) gap.

# Assembly Instructions

## Step 5

### Drawer assembly

**a:** Connect the drawer sides **8** to the drawer back **9** using bolts **F** as shown.

Insert the drawer base **13** into the grooves on the sides and back. Ensure the drawer base **13** is the correct way up.

Attach the inner drawer front **8** to the sides using bolts **F**.

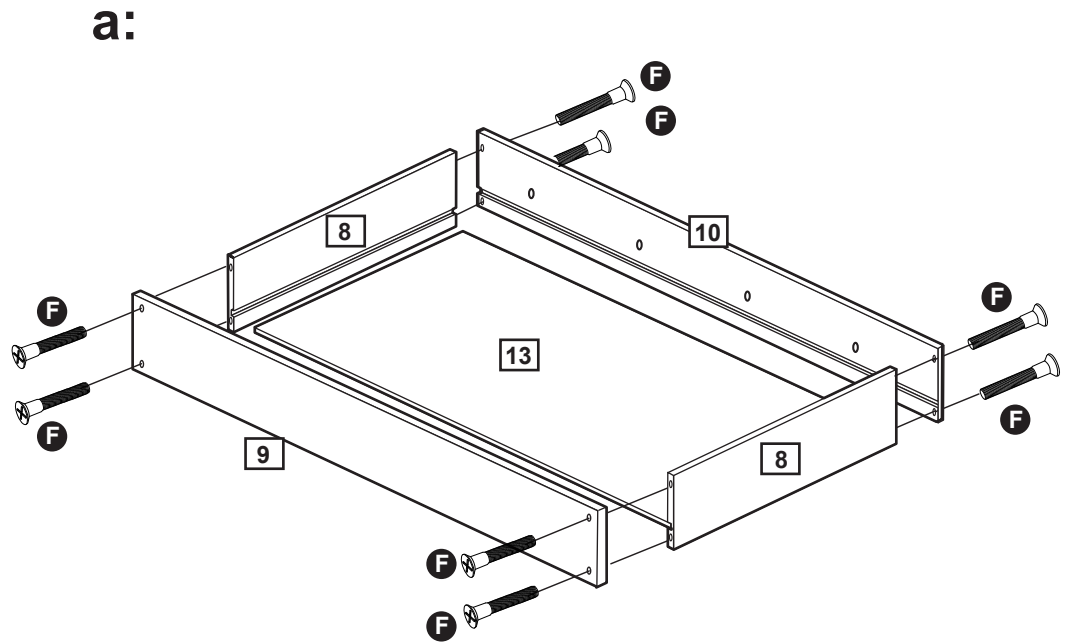

**b:** Turn the drawers upside down and secure drawer base **13** into place with 3 x drawer base supports **11** and **12** using bolts **J** and nuts **I** as shown.

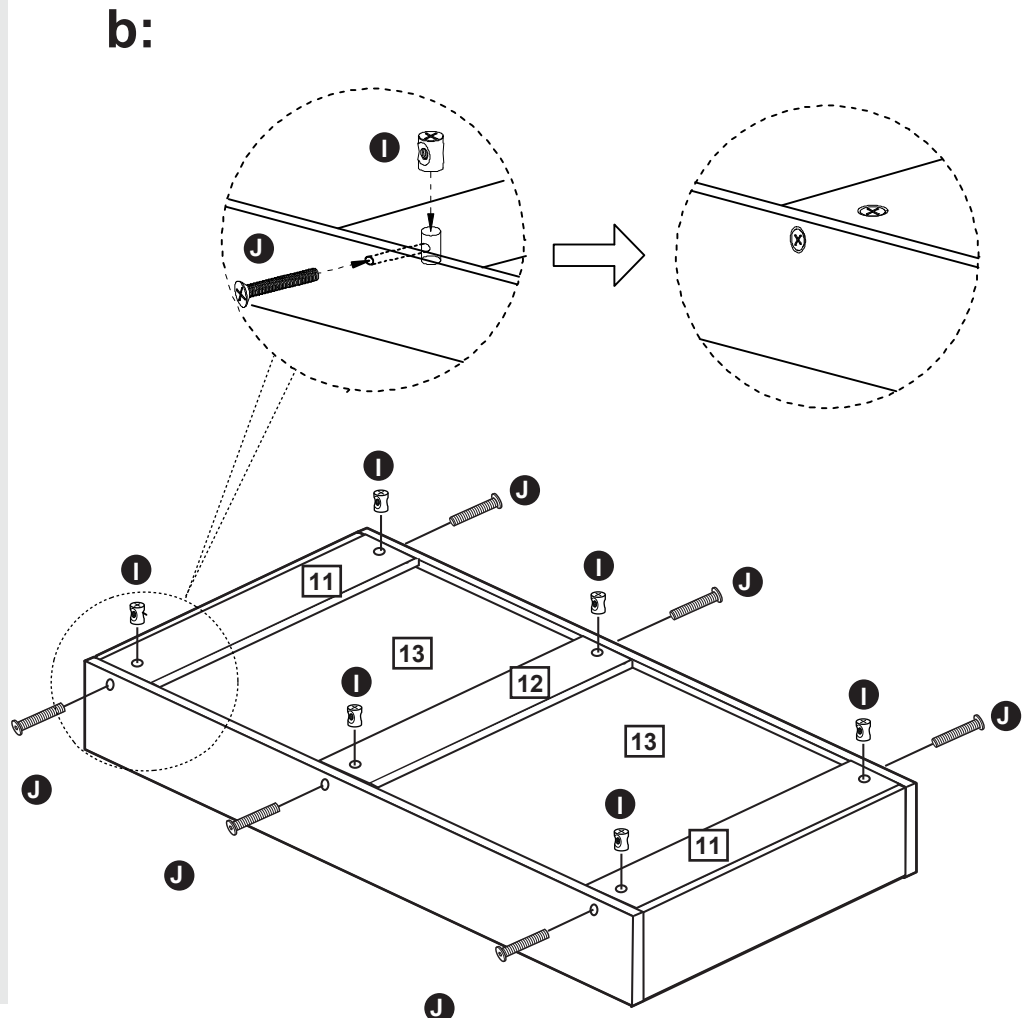



# Assembly Instructions

## Step 6

a: Attach the wheels **K** to the drawer base supports **11** using Screw **G** as shown.

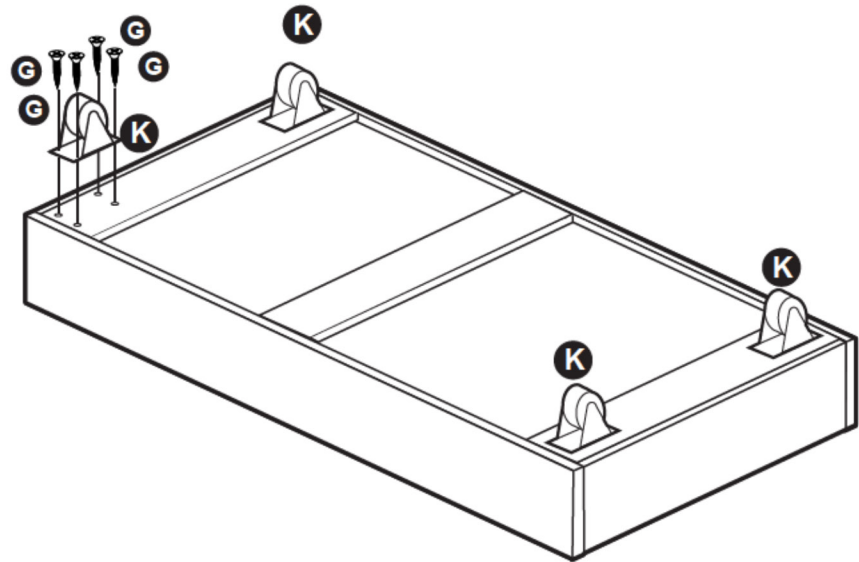

b: Attach the drawer front **7** to the inner drawer front **10** using 4 bolts **H** and washers **E** as shown.

Repeat steps **5** and **6** for the other drawer.

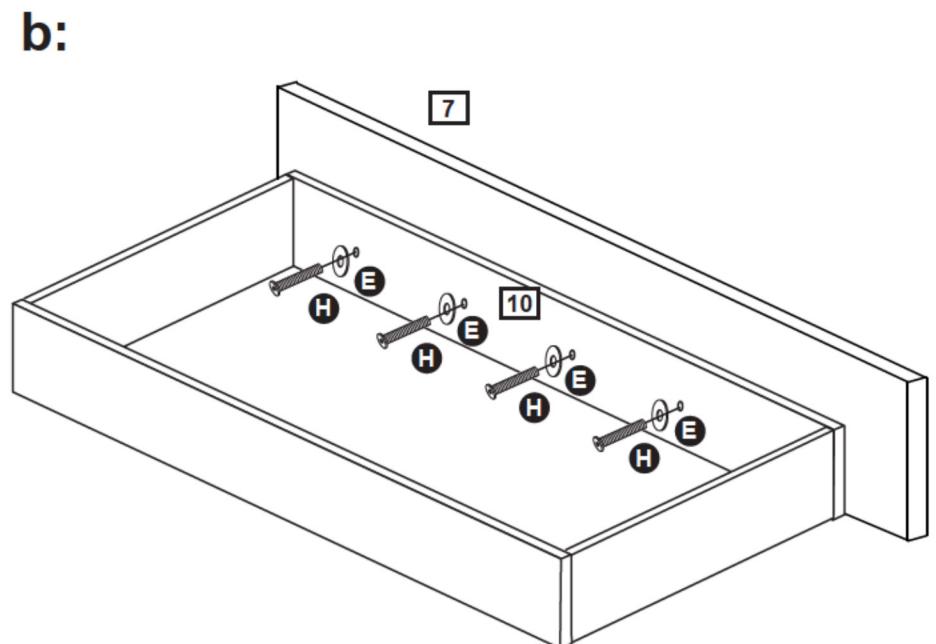

# Assembly Instructions

## Step 7

### Place slats

a: Slot the bed slats **6** into the end slat caps **M** and central slat caps **N** as shown.

a:

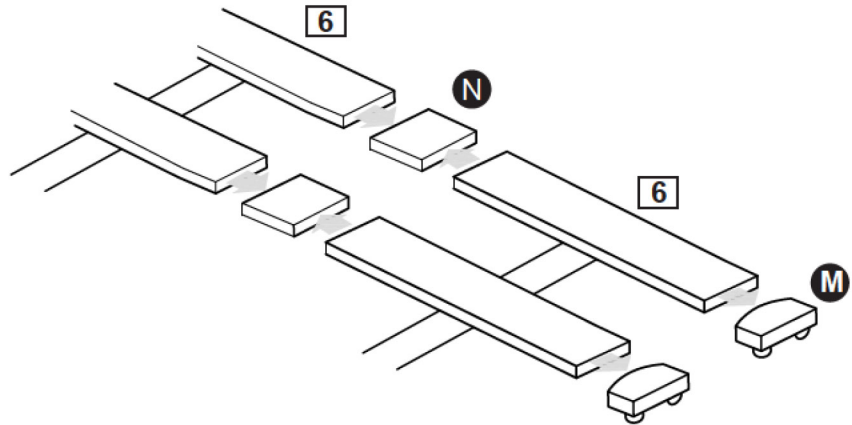

b: Attach the slats to the side rails **1** & **2** and central support rail **5** by firmly pushing into place. Insert the drawers into the bed side rails.

**After all the parts are positioned you can now fully tighten all bolts fixed on previous steps.**

**Assembly is complete.**

b:

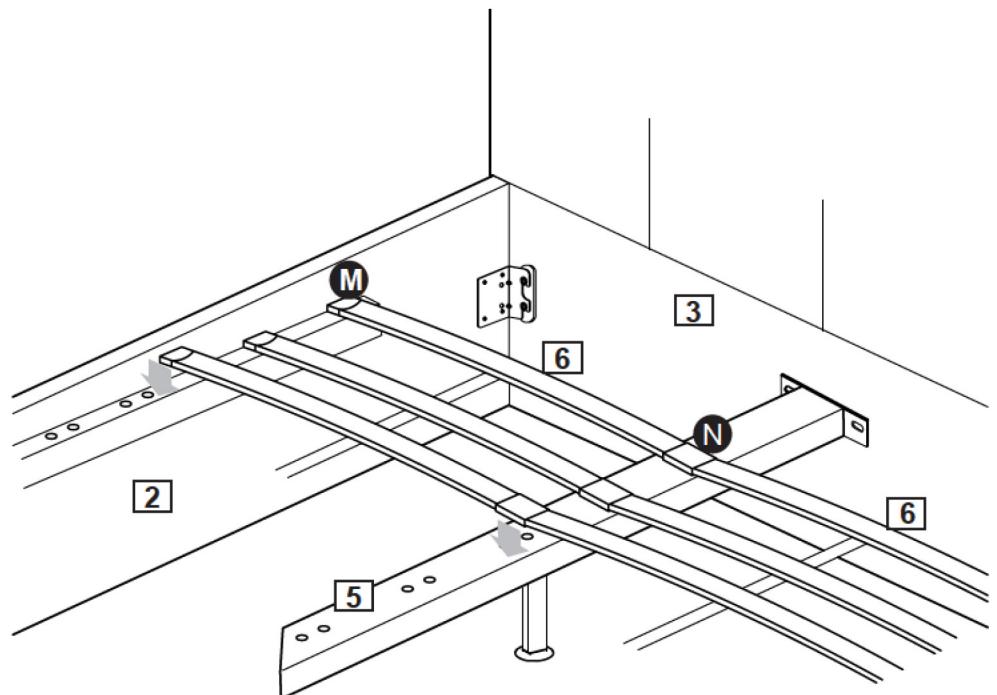

If you need help or have damaged or missing parts, call the **Customer Helpline:**  
**Argos = 0345 6400800**