

Vendor Name:	House & Home Asia Inc.
Product Name:	Gabe 4' Bed
Code:	6176079
Date:	19/11/2016

Instruction Manual

GABE BLACK

Assembly Instructions – Please keep for future reference	617/6079
	622/7076
	651/0587

THE
COLLECTION
BY ARGOS



Dimensions(4')	Dimensions(4'6")	Dimensions(5')
Width - 201cm	Width - 201cm	Width - 215cm
Depth - 126cm	Depth - 145cm	Depth - 160,5cm
Height - 120,5cm	Height - 120,5cm	Height - 120,5cm

Important – Please read these instructions fully before starting assembly

If you need have damaged or missing parts, call the Customer Helpline:
Argos = 0345 6400800

Issue 1 • 12/05/16

Insert Additional Pages If Required.

Vendor Name:	House & Home Asia Inc.
Product Name:	Gabe 4' Bed
Code:	6176079
Date:	19/11/2016

Instruction Manual

Instruction Manual	2	of	9
--------------------	---	----	---

Safety and Care Advice

Important – Please read these instructions fully before starting assembly

- Check you have all the components and tools listed on the following pages.
- Remove all fittings from the plastic bags and separate them into their groups.
- Keep children and animals away from the work area, small parts could choke if swallowed.
- Parts of the assembly will be easier with 2 people.
- Make sure you have enough space to layout the parts before starting.
- Assemble the item as close to its final position (in the same room) as possible.
- Dispose of all packaging carefully and responsibly.
- Place the product on flat and steady surface during use.
- Assemble on a soft level surface to avoid damaging the unit or your floor.
- Keep these instructions for further use.
- To ensure an easier assembly we strongly advise that all fittings are only finger tightened during initial assembly. Only upon completion of the assembly should all fixing points be fully tightened.

Care and maintenance

- Only clean using a damp cloth and mild detergent, do not use bleach or abrasive cleaners.
- From time to time check that there are no loose screws on this unit.
- This product should not be discarded with household waste. Take to your local authority waste disposal center.

Handy Hints

- Assemble all parts and bolts loosely during assembly, only once the product is complete should you fully tighten the bolts
- Regularly check and ensure that all bolts and fittings are tightend properly.

Insert Additional Pages If Required.

Vendor Name:	House & Home Asia Inc.
Product Name:	Gabe 4' Bed
Code:	6176079
Date:	19/11/2016

Instruction Manual

Instruction Manual	3	of	9
--------------------	---	----	---

Components - Panels If you have damaged or missing components, call the Customer Helpline: Argos = 0346 8400800

Please check you have all the panels listed below

- 1** Headboard Post Left (120.7 x 8cm)
- 2** Headboard Post Right (120.7 x 8cm)
- 3** Footboard Post Left (74.3 x 8cm)
- 4** Footboard Post Right (74.3 x 8cm)
- 5** Side Rail Part 1 x 2 (99.6 x 5cm)
- 6** Side Rail Part 2 x 2 (99.6 x 5cm)
- 7** Brace 01 (140.9 x 2.5cm)
- 8** Brace 02 x 2 (140.9 x 2.5cm)
- 9** Brace 03 x 2 (92.5 x 2.5cm)
- 10** Headboard Guard Rail (144.7 x 72cm)
- 11** Footboard Guard Rail (144.7 x 37.5cm)
- 12** Slats x 14 (138.7 x 1.6cm)
- 13** Center Legs x 3 (32 x 6.5cm)
- 14** Plastic Plug x 28
- 15** Bracket

Insert Additional Pages If Required.

Vendor Name:	House & Home Asia Inc.
Product Name:	Gabe 4' Bed
Code:	6176079
Date:	19/11/2016









Instruction Manual

Instruction Manual	4	of	9
--------------------	---	----	---

Components - Fittings

Please check you have all the panels listed below

Note: The quantities below are the correct amount to complete the assembly. In some cases more fittings may be supplied are required.

<p>A</p>  <p>40mm Bolt x 20</p>	<p>B</p>  <p>25mm Bolt x 8</p>	<p>C</p>  <p>17mm Bolt x 8</p>
<p>D</p>  <p>Metal washer x 8</p>	<p>E</p>  <p>Plastic washer x 8</p>	<p>F</p>  <p>Spring washer x 8</p>
<p>G</p>  <p>M6 Nut x 4</p>	<p>H</p>  <p>Allen Key x 1</p>	<p>I</p>  <p>Wrench x 1</p>

Tools required

 Ruler/tape measure

Ruler - User this ruler to help correctly identify the screws

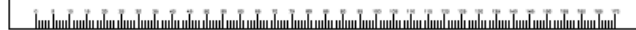

Vendor Name:	House & Home Asia Inc.
Product Name:	Gabe 4' Bed
Code:	6176079
Date:	19/11/2016

Instruction Manual

Instruction Manual	5	of	9
--------------------	---	----	---

Assembly Instructions

Step 1

Secure the headboard post left **1** and headboard post right **2** to the headboard guard rail **10** using bolts **6**.

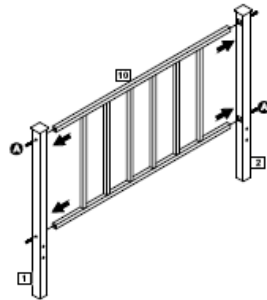

Step 2

Secure the footboard post left **3** and footboard post right **4** to the footboard guard rail **11** using bolts **6**.

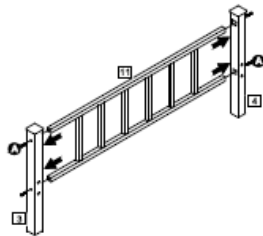

5

Insert Additional Pages If Required.

Vendor Name:	House & Home Asia Inc.
Product Name:	Gabe 4' Bed
Code:	6176079
Date:	19/11/2016

Instruction Manual

Instruction Manual	6	of	9
--------------------	---	----	---

Assembly Instructions

Step 3

Secure the side rail part 2 (E) to the side rail part 1 (F) using bolts (G).

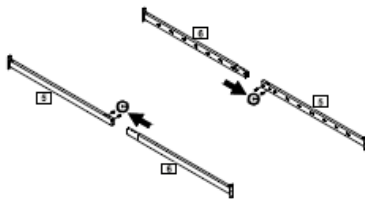
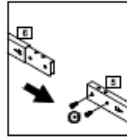

Step 4

a: Secure the brace 02 (A) to the side rail part 2 (E) and side rail part 1 (F) using bolts (B).

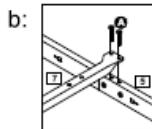
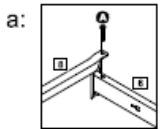

b: Secure the brace 01 (C) to the side rail part 1 (F) using bolts (B).

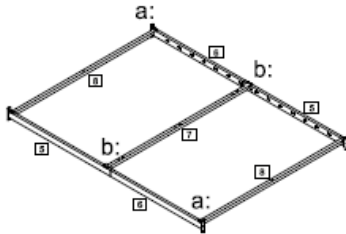

6

Insert Additional Pages If Required.

Vendor Name:	0
Product Name:	0
Code:	0
Date:	00/01/1900

Instruction Manual

Assembly Instructions

Step 5

Secure the center legs **15** to the brace **01** using bolts **0**.

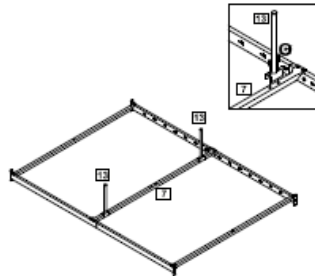

Step 6

Secure the side rail **02** and side rail **01** to the headboard post left **1**, headboard post right **2**, footboard post left **3** and footboard right **4** using bolts **0**, **0**, **0**, **0**.

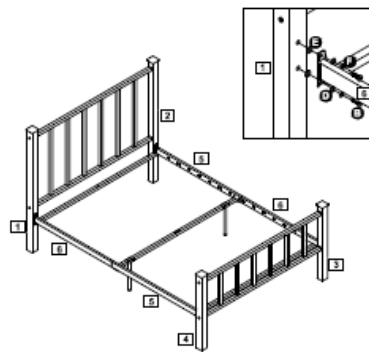

7



Vendor Name:	0
Product Name:	0
Code:	0
Date:	00/01/1900

Instruction Manual

Assembly Instructions

Step 7

a: Secure the brace **03** to the brace **01**.

a:



b:



b: Secure the brace 03
 11 to the brace 01 12
 using bolts 0 and 0.

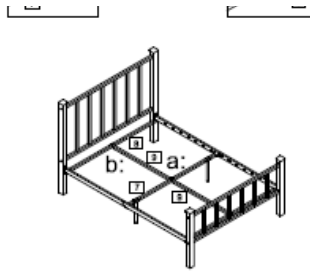

Step 8

Secure the bracket 13 to
 the center legs 14 using
 bolts 0 and 0.

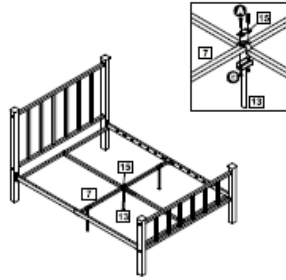

8



Vendor Name:	0
Product Name:	0
Code:	0
Date:	00/01/1900

Instruction Manual

Instruction Manual	9	of	9
--------------------	---	----	---

Assembly Instructions

Step 9

a: Secure the slats 02 to
 the side rail part 2 01 and
 side rail part 1 01.

b: Secure the plastic plug
 03 to the side rail part 02
 01 and side rail part 01
 01.

Assembly is complete.

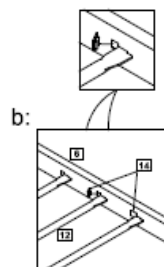
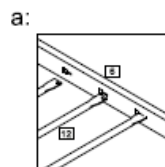

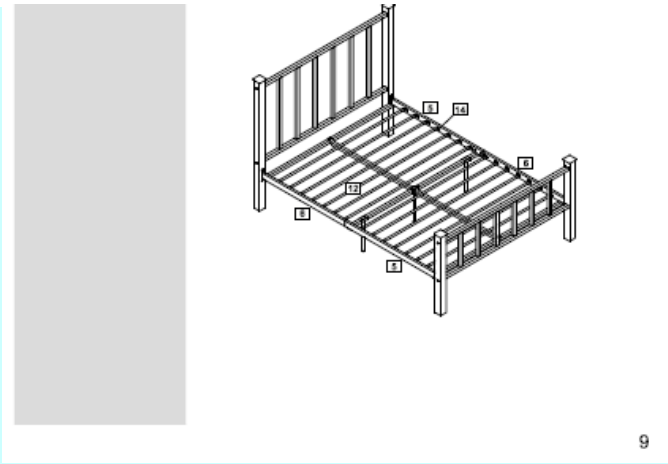

9