

**SAMSUNG**

SM-R760  
SM-R765F  
SM-R770

# User Manual

# Table of Contents

## Getting Started

- 5 About the Gear S3**
- 6 Read me first**
- 7 Maintaining water and dust resistance**
- 8 Device layout**
  - 8 Package contents
  - 9 Gear
  - 11 Wireless charging dock
- 12 Battery**
  - 12 Charging the battery
  - 14 Battery charging tips and precautions
  - 15 Power saving mode
- 16 Wearing the Gear**
  - 16 Putting on the Gear
  - 16 Band tips and precautions
  - 17 Replacing the band
- 19 Turning the Gear on and off**
- 20 Connecting the Gear to a mobile device**
  - 20 Installing the Samsung Gear app
  - 20 Connecting the Gear to a mobile device via Bluetooth
  - 22 Remote connection

- 23 eSIM (SM-R765F)**
  - 23 Introduction
  - 23 Activating the eSIM
  - 25 Managing the eSIM
- 25 Using the Gear without a mobile device**

## Basics

- 26 Controlling the screen**
  - 26 Screen composition
  - 27 Turning the screen on and off
  - 27 Navigating the screen
  - 29 Using the bezel
  - 31 Touchscreen
  - 34 Status panel
- 36 Watch**
  - 36 Watch screen
  - 36 Changing the watch face
  - 37 Using the Watch always on feature
  - 37 Power-off watch mode
- 37 Notifications**
  - 37 Notification panel
  - 38 Viewing incoming notifications
  - 39 Sending app notifications to the Gear

**39 Entering text**

- 39 Introduction
- 40 Using the voice input
- 40 Using emoticons
- 41 Using handwriting input mode or the keyboard

**42 GPS**

**43 SOS messages**

**44 Finding my Gear**

## Applications

**45 Messages**

**46 Phone**

- 46 Introduction
- 46 Setting an outgoing number
- 47 Receiving calls
- 49 Making calls
- 49 Options during calls
- 50 Forwarding calls to the Gear

**52 Contacts**

**53 S Health**

- 53 Introduction
- 55 24-hour Log
- 56 Steps
- 57 Floors
- 58 Exercise
- 60 Heart rate
- 62 Water
- 62 Caffeine
- 63 Together
- 64 Additional information

**65 Alti-Barometer**

**68 Music Player**

- 68 Introduction
- 68 Playing music
- 68 Importing music
- 69 Playing music on the Gear
- 69 Playing music from your mobile device
- 69 Standalone music

**70 Reminders**

**71 Schedule**

**71 S Voice**

- 71 Introduction
- 71 Setting a wake-up command
- 72 Using S Voice
- 73 Setting the language

**73 Weather**

**73 Alarm**

**74 World Clock**

**75 Gallery**

- 75 Importing and exporting images
- 76 Viewing images
- 76 Deleting images

**77 News Briefing**

**77 Find My Phone**

**78 Email**

**78 Get more apps**

**79 Settings**

- 79 Introduction
- 79 Style
- 79 Sounds and vibration
- 80 Device
- 81 Display
- 81 Call

- 82 Messages
- 82 Connections
- 87 Security
- 87 Accessibility
- 87 Input
- 87 Power saving
- 88 Gear info
- 88 Connect to new phone
- 88 Connect to phone
- 89 Updating the Gear

## Appendix

- 99 Troubleshooting
- 103 Removing the battery

## Samsung Gear app

- 90 Introduction
- 91 INFO
- 92 SETTINGS
  - 92 Watch faces
  - 92 Notifications
  - 93 Apps
  - 93 Send content to Gear
  - 94 Send SOS requests
  - 94 Find My Gear
  - 95 Gear connection
  - 95 Quick messages
  - 95 Register Gear eSIM profile
  - 96 Auto call forwarding
  - 96 Social network sharing
  - 96 S Health
  - 97 Samsung Galaxy Apps
  - 97 About Gear
  - 98 About Samsung Gear app

# Getting Started

## About the Gear S3

The Gear S3 is a smartwatch that works as a traditional watch and allows you to use a variety of convenient apps for making phone calls, playing music, and managing your health. By rotating the bezel, you can access convenient features quickly and easily. You can also change the watch face and band to your taste.

Connect your Gear S3 to your mobile device to expand your mobile device experience, or use the Gear S3 by itself, without connecting to a mobile device.



## Read me first

Please read this manual before using this device to ensure safe and proper use.

- Descriptions are based on the device's default settings.
- Some content may differ from your device depending on the region, service provider, model specifications, or device's software.
- Content (high quality content) that requires high CPU and RAM usage will affect the overall performance of the device. Apps related to the content may not work properly depending on the device's specifications and the environment that it is used in.
- Samsung is not liable for performance issues caused by apps supplied by providers other than Samsung.
- Samsung is not liable for performance issues or incompatibilities caused by edited registry settings or modified operating system software. Attempting to customise the operating system may cause the Gear or apps to work improperly.
- Software, sound sources, wallpapers, images, and other media provided with this Gear are licensed for limited use. Extracting and using these materials for commercial or other purposes is an infringement of copyright laws. Users are entirely responsible for illegal use of media.
- You may incur additional charges for data services, such as messaging, uploading and downloading, auto-syncing, or using location services depending on your data plan. For large data transfers, it is recommended to use the Wi-Fi feature.
- Default apps that come with the Gear are subject to updates and may no longer be supported without prior notice. If you have questions about an app provided with the Gear, contact a Samsung Service Centre. For user-installed apps, contact service providers.
- Modifying the Gear's operating system or installing softwares from unofficial sources may result in Gear malfunctions and data corruption or loss. These actions are violations of your Samsung licence agreement and will void your warranty.
- The images in this manual are based on the SM-R760 model.
- Some functions may not work as described in this manual depending on the maker and model of the mobile device you connect to the Gear.

## Instructional icons



**Warning:** situations that could cause injury to yourself or others



**Caution:** situations that could cause damage to your device or other equipment



**Notice:** notes, usage tips, or additional information

## Maintaining water and dust resistance

Your device supports water- and dust-resistance. Follow these tips carefully to maintain the water- and dust-resistance of your device. Failure to do so may result in damage to your device.

- Do not immerse the device in water deeper than 1.5 m or keep it submerged for more than 30 minutes.
- Do not expose the device to **water moving with force**.
- When you are wearing the device, avoid taking a shower or going swimming.
- If the device or your hands are wet, dry them thoroughly before handling the device.
- **If the device is exposed to clean water, dry it thoroughly with a clean, soft cloth. If the device is exposed to other liquids, such as salt water, ionised water, or alcoholic beverage, rinse it with clean water and dry it thoroughly with a clean, soft cloth. If you do not follow these instructions, the device's performance and appearance may be affected.**
- **If the device is dropped or receives an impact**, the water- and dust-resistant features of the device may be damaged.
- **If the device has been immersed in water or the microphone or speaker is wet**, sound may not be heard clearly during a call. Wipe the device with a dry cloth or dry it thoroughly before using it.

- The touchscreen and other features may not work properly **if the device is used in water.**
- **Your device has been tested in a controlled environment and certified to be water- and dust-resistant in specific situations (meets requirements of classification IP68 as described by the international standard IEC 60529 - Degrees of Protection provided by Enclosures [IP Code]; test conditions: 15 - 35°C, 86 - 106 kPa, 1.5 metre, 30 minutes).** Despite this classification, it is still possible for your device to be damaged in certain situations.

## Device layout

### Package contents

Check the product box for the following items:

- Gear
- Wireless charging dock
- Band
- Quick start guide



- If the connected band is too large for your wrist, change it to a small one.
- The items supplied with the Gear and any available accessories may vary depending on the region or service provider.
- The supplied items are designed only for this Gear and may not be compatible with other devices.
- Appearances and specifications are subject to change without prior notice.
- You can purchase additional accessories from your local Samsung retailer. Make sure they are compatible with the Gear before purchase.
- Some accessories, such as docking devices, may not have the same water- and dust-resistance certification.
- Use only Samsung-approved accessories. Using unapproved accessories may cause the performance problems and malfunctions that are not covered by the warranty.
- Availability of all accessories is subject to change depending entirely on manufacturing companies. For more information about available accessories, refer to the Samsung website.



## Gear

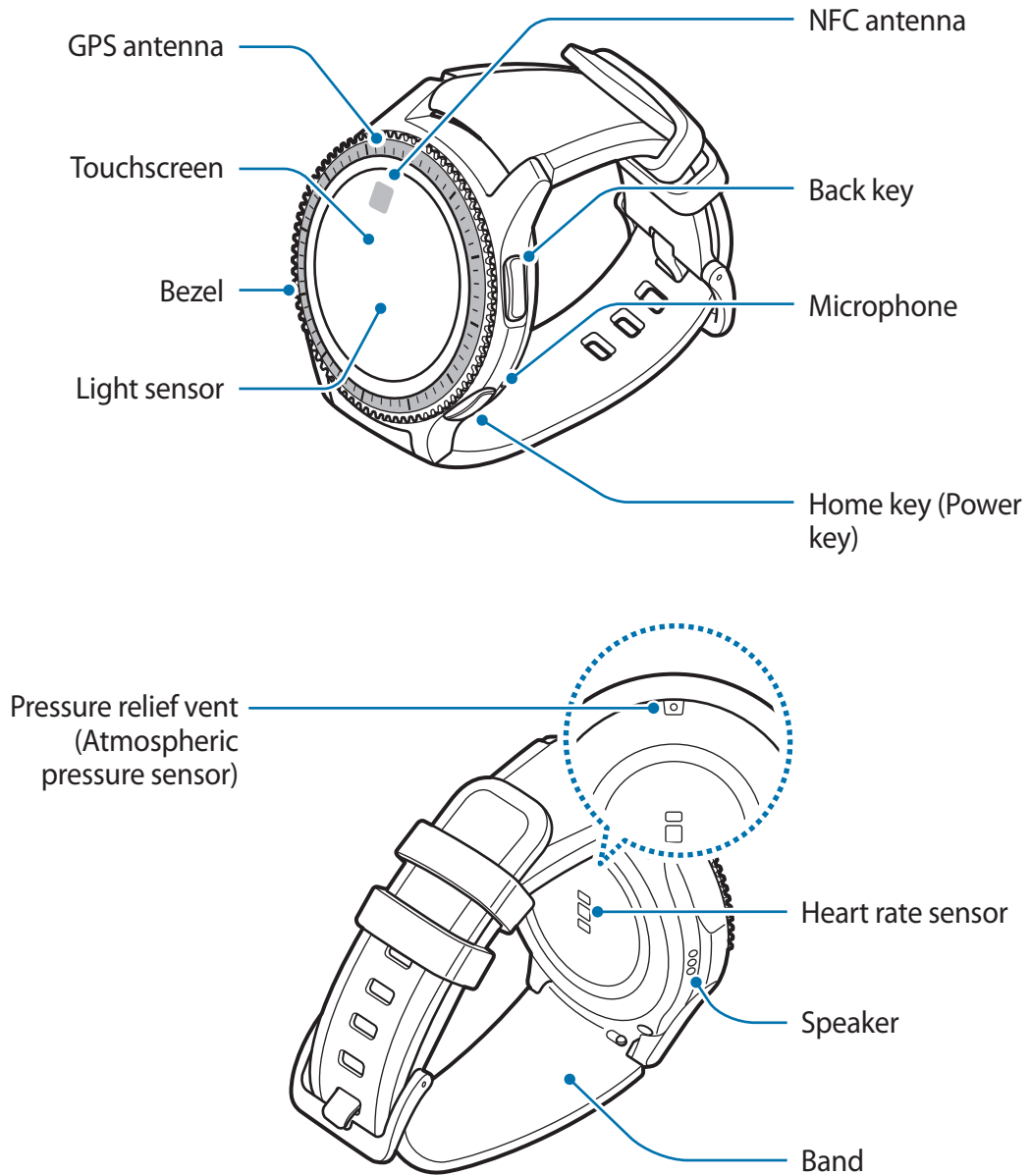

### ► SM-R760, SM-R765F

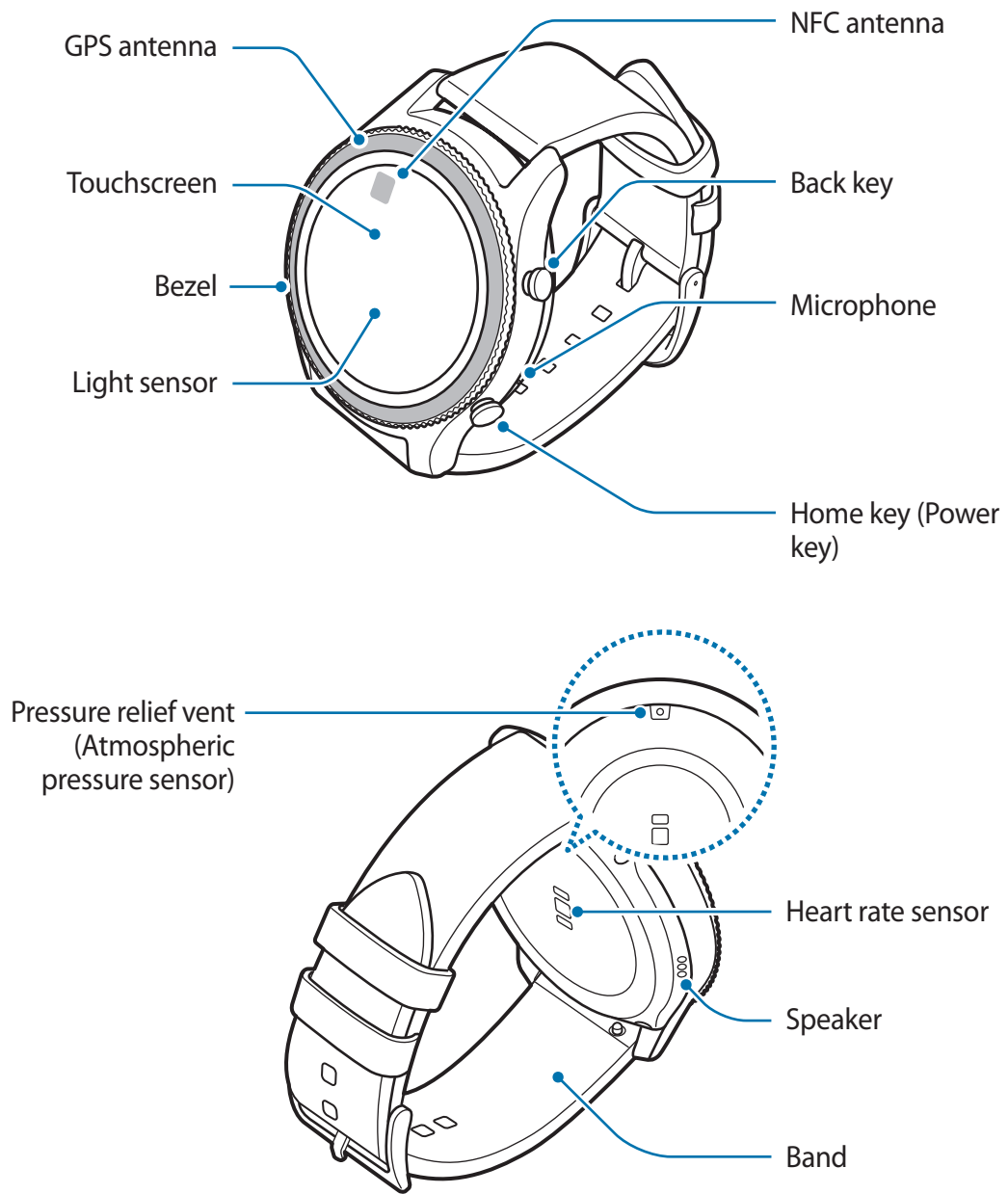

► SM-R770



## Keys

Key	Function
 <b>Home/Power</b>	<ul style="list-style-type: none"> <li>• Press and hold to turn the Gear on or off.</li> <li>• Press to turn on the screen.</li> <li>• Press and hold for more than 7 seconds to restart the Gear.</li> <li>• Press to open the Apps screen when you are on the Watch screen.</li> <li>• Press to open the Watch screen when you are on any other screen.</li> </ul>
 <b>Back</b>	<ul style="list-style-type: none"> <li>• Press to return to the previous screen.</li> </ul>



Ensure that the band is kept clean. Contact with contaminants, such as dust and dye, can cause stains on the band that may not be fully removed.



- If the loud speaker is wet, sound may be distorted. Ensure that the loud speaker is dry.
- Make sure the Gear's microphone is not obstructed when you are speaking into it.

## Wireless charging dock

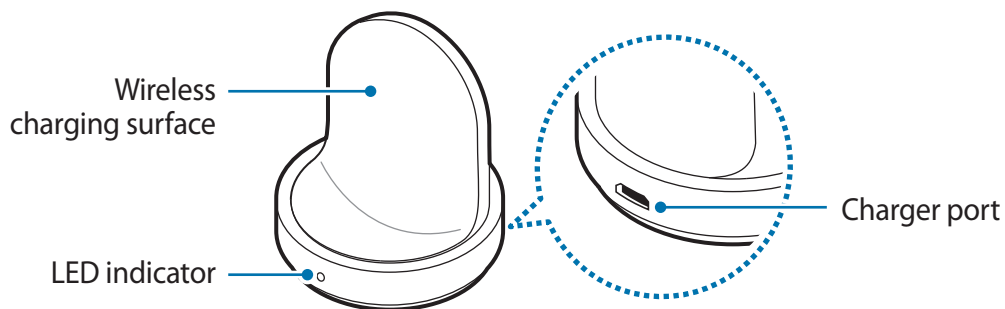

Do not expose the wireless charging dock to water.

# Battery

## Charging the battery

Charge the battery before using it for the first time or when it has been unused for extended periods.



Use only Samsung-approved chargers, batteries, and cables. Unapproved chargers or cables can cause the battery to explode or damage the Gear.



- Use the supplied wireless charging dock and charger. The Gear cannot be charged properly with a third-party charger.
- Connecting the charger improperly may cause serious damage to the device. Any damage caused by misuse is not covered by the warranty.



To save energy, unplug the charger when not in use. The charger does not have a power switch, so you must unplug the charger from the electric socket when not in use to avoid wasting power. The charger should remain close to the electric socket and be easily accessible while charging.

- 1 Plug the small end of the charger into the multipurpose jack of the wireless charging dock and plug the large end of the charger into an electric socket.

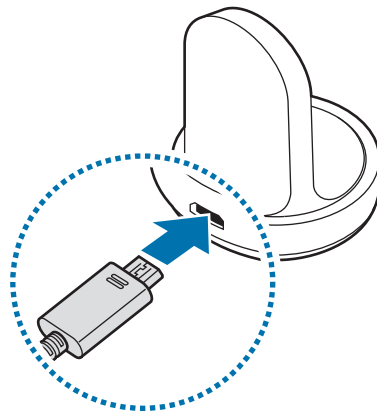

2 Place the Gear into the wireless charging dock.

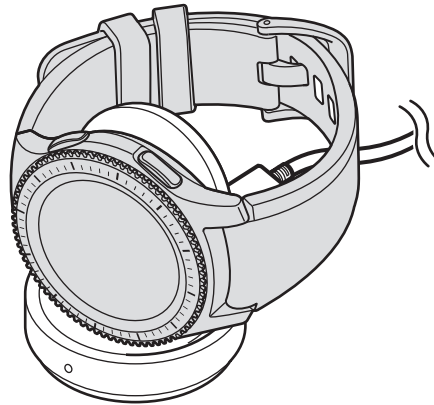

### Checking the charging status

When you connect the Gear and the wireless charging dock, the wireless charging dock's LED indicator flashes certain colours to indicate the battery level.

Colour	Charging status
Red	Charging
Green	Fully charged
Orange	Connected to a low-power adaptor



When a wireless charging dock error occurs, the LED indicator flashes red. Disconnect the Gear from the wireless charging dock and reconnect them. If the error occurs again, contact a Samsung Service Centre for service support.

## Reducing the battery consumption

Your Gear provides various options that help you conserve battery power.

- When you are not using the Gear, turn off the screen by covering the screen with your palm.
- Activate power saving mode.
- Close unnecessary apps.
- Deactivate the Bluetooth feature when not in use.
- Deactivate the Wi-Fi feature when not in use.
- Decrease the screen brightness.
- Deactivate the watch always on feature.
- Deactivate the voice wake-up feature in **S Voice**.
- Customise the notification settings in **Samsung Gear** on the mobile device.

## Battery charging tips and precautions

- If there are obstructions between the Gear and the wireless charging dock, the Gear may not charge properly. Prevent the Gear and the wireless charger from coming into contact with sweat, liquids, or dust.
- When the battery power is low, the battery icon appears empty.
- If the battery is completely discharged, the Gear cannot be turned on immediately when the charger is connected. Allow a depleted battery to charge for a few minutes before turning on the Gear.
- If you use multiple apps at once, the battery will drain quickly. To avoid losing power during a data transfer, always use these apps after fully charging the battery.
- Using a power source other than the charger, such as a computer, may result in a slower charging speed due to a lower electric current.
- If the Gear is being charged with other devices via a multicharger, charging may take longer.

- The Gear can be used while it is charging, but it may take longer to fully charge the battery.
- If the Gear receives an unstable power supply while charging, the touchscreen may not function. If this happens, disconnect the Gear from the wireless charging dock.
- While charging, the Gear may heat up. This is normal and should not affect the Gear's lifespan or performance. If the battery gets hotter than usual, the charger may stop charging.
- If the Gear is not charging properly, take the Gear to a Samsung Service Centre.
- Avoid using a bent or damaged USB cable.

## Power saving mode

Activate power saving mode to extend the battery's usage time.

- Displays colours on the screen as grey tones.
- Deactivates features, excluding phone, messages, and notifications.
- Deactivates the Wi-Fi feature.
- Limits the performance of the Gear's CPU.

On the Apps screen, tap  (**Settings**) → **Power saving** → ✓. Alternatively, press and hold the Home key and tap **Power saving** → ✓.

To deactivate this mode, tap **OFF** → ✓. Alternatively, press and hold the Home key and tap **Power saving** → ✓.

## Wearing the Gear

### Putting on the Gear

Open the buckle and place the band around your wrist. Fit the band to your wrist, insert the pin into an adjustment hole, and then secure the buckle to close it.

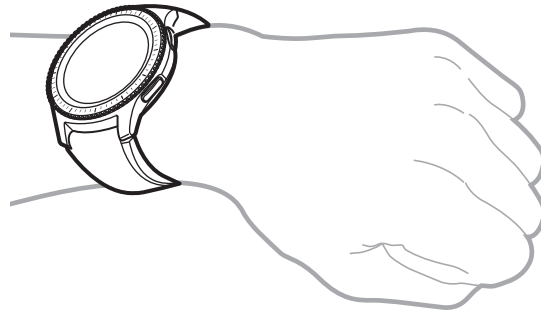

Do not bend the band excessively. Doing so may damage the Gear.



To measure your heart rate more accurately with the Gear, wear the Gear firmly around your lower arm just above the wrist. Refer to [Wearing the Gear correctly](#) for details.

### Band tips and precautions

- Be cautious when wearing the Gear. If you have sensitive skin or fasten the Gear too tightly, you may feel some discomfort.
- Some people may experience discomfort when wearing the Gear for prolonged periods.
- Skin irritation may occur if the band is exposed to soap, sweat, allergens, or pollutants for long periods.
- Do not wear the device too tightly. Make sure to keep the device clean and dry. Though this device has met international safety standards, some people may experience skin irritation if they are allergic to certain substances.



- Keep in mind the followings to protect the leather band.
  - Avoid exposing the leather band to direct sunlight, water, and hot or humid environments. The leather band can become discoloured or deformed.
  - The leather is permeable so it can be contaminated by oil and cosmetics. Avoid exposing the leather band to these products.
- Using a metal band is not recommended. Metal bands may cause connectivity problems in areas with weak signals or poor reception.

## Replacing the band

Detach the band from the Gear to replace it with a new one.



The band's appearance may vary depending on your model.

- 1 Slide the band's spring bar inwards.

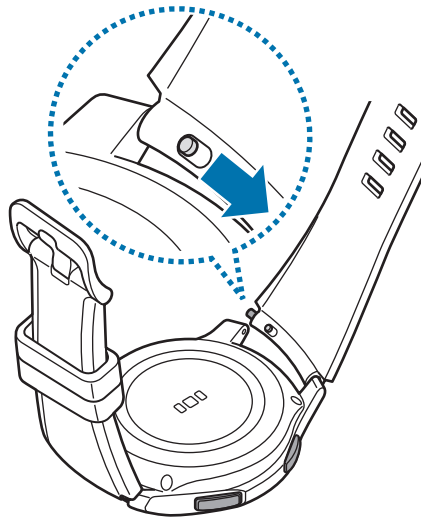

- 2 Pull the band away from the Gear's body.

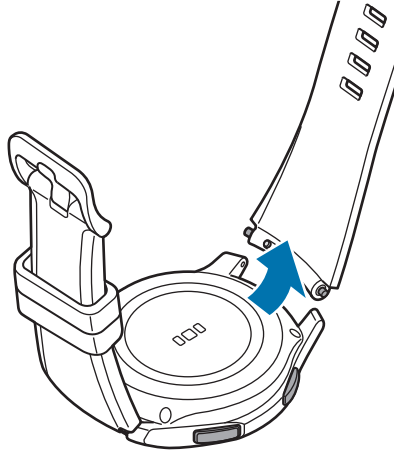

- 3 Insert one end of the spring bar into the Gear's lug.

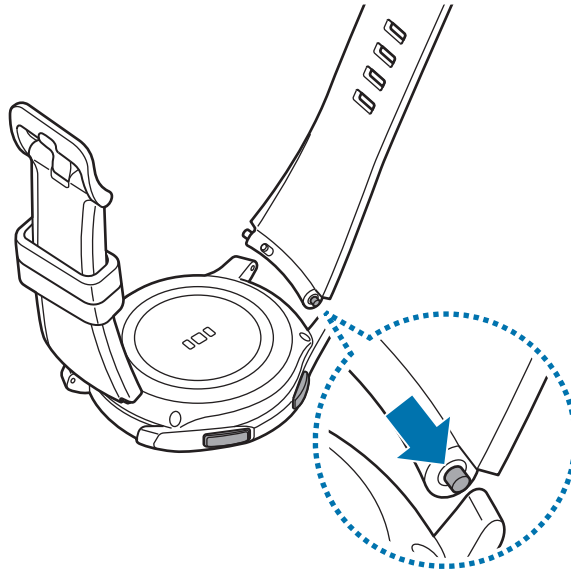

4 Slide the spring bar inwards and connect the band.

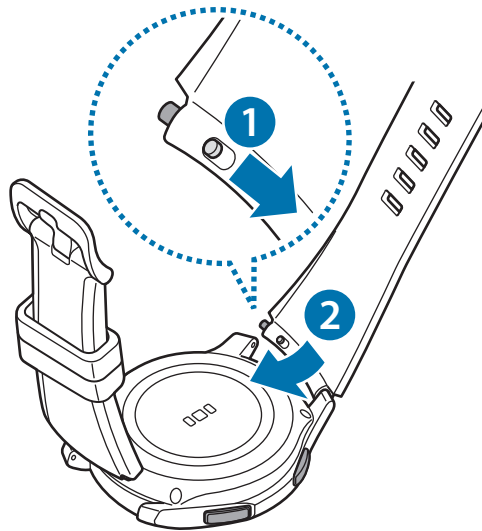

## Turning the Gear on and off

Press and hold the Home key (Power key) for a few seconds to turn on the Gear. When you turn on the Gear for the first time or reset it, a pop-up window will appear. Follow the on-screen instructions to download and install the Samsung Gear app on your mobile device. Refer to [Connecting the Gear to a mobile device](#) for details.

To turn off the Gear, press and hold the Home key (Power key), and then tap **Power off**.

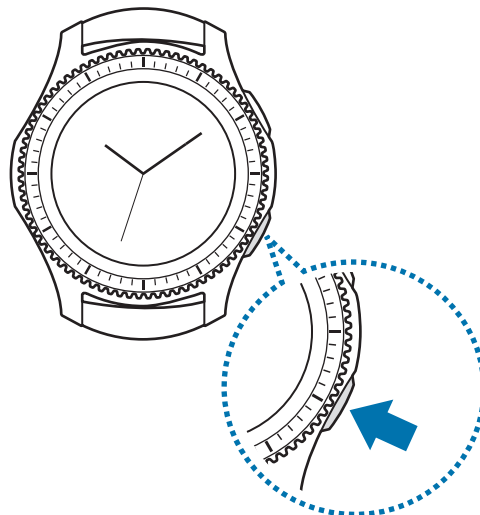

Follow all posted warnings and directions from authorised personnel in areas where the use of wireless devices is restricted, such as aeroplanes and hospitals.

## Restarting the Gear

If your Gear is frozen and unresponsive, press and hold the Home key (Power key) for more than 7 seconds to restart it.

# Connecting the Gear to a mobile device

## Installing the Samsung Gear app

To connect your Gear to a mobile device, install the Samsung Gear app on the mobile device. Depending on your mobile device, you can download the Samsung Gear app from the following places:

- Samsung Android devices: **Galaxy Apps**, [apps.samsung.com/gear](https://apps.samsung.com/gear)
- Other Android devices: **Play Store**, [apps.samsung.com/gear](https://apps.samsung.com/gear)
- iOS devices: **App Store**



You cannot install the Samsung Gear app on the mobile devices that do not support Gear syncing. Ensure that your mobile device is compatible with a Gear.

## Connecting the Gear to a mobile device via Bluetooth

### Gear

1 Turn on the Gear.

When you turn on the Gear, a pop-up window will appear about downloading and installing the Samsung Gear app on your mobile device.

### Mobile device

2 On your mobile device, launch **Samsung Gear**.

3 Tap **CONNECT TO GEAR**.

4 Tap **OK** when the Bluetooth activation request window appears.

**5** Follow the on-screen instructions to complete the connection.

To make calls or send messages from the Gear, you should activate the eSIM. Refer to [eSIM \(SM-R765F\)](#) for more information.

When the devices are connected, an on-screen tutorial will appear on the Gear's screen. Follow the on-screen instructions to learn the Gear's basic controls.

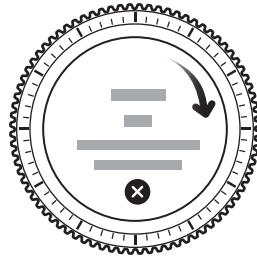

- Connection methods and screenshots may vary depending on your device and software version.
- The Gear is smaller than normal mobile devices so the network quality may be lower, especially in areas with weak signals or poor reception. If a Bluetooth connection is not available, your cellular network or Internet connection may be poor or disconnected.
- When connected, the Gear's battery may drain more quickly while syncing data, such as contacts.
- Supported mobile devices and features may vary depending on your region, service provider, and device manufacturer. Visit [www.samsung.com](http://www.samsung.com) to see a list of compatible devices.

## Connecting the Gear to a new mobile device

When you connect the Gear to another mobile device, a pop-up window will ask you to reset the Gear. Make sure you back up any important data stored in your Gear. For more information about backing up your Gear, refer to [Backing up and restoring data](#).

- 1 On your Gear, open the Apps screen, tap  (**Settings**) → **Connect to new phone**.

The connection between your Gear and your mobile device will end. After a light reset, it will automatically enter Bluetooth pairing mode.

- 2 On another mobile device, launch **Samsung Gear** to connect to your Gear.



If the mobile device you want to connect to is already connected to another Gear, your Gear cannot establish a connection. Disconnect your mobile device from the previous Gear to connect to your current Gear.

## Remote connection

Your Gear and mobile device are connected via Bluetooth. When a Bluetooth connection is not available, you can remotely connect the Gear to your mobile device by using your Samsung account via Wi-Fi network. This allows you to continue receiving notifications from your mobile device.

This feature is automatically activated when you connect to your mobile device via Bluetooth for the first time.

If this feature is not turned on, launch **Samsung Gear** on your mobile device, tap **SETTINGS** → **Gear connection**, and then tap the **Remote connection** switch.

## eSIM (SM-R765F)

### Introduction

Your Gear includes an eSIM, which functions as a SIM card so that you do not need a SIM card to make calls, send messages, or use a mobile data connection with the Gear.

Install a profile and activate the eSIM. For more information, contact your service provider.

### Activating the eSIM

To use the eSIM, you must download a profile and activate the eSIM. Ensure that the Gear is able to connect to a network.

When you connect your Gear to your mobile device for the first time, follow the on-screen instructions to activate the eSIM. If you skip the eSIM installation step, you can set it up later.

#### **Gear**

- 1 On the Watch screen, swipe downwards from the top edge of the screen to open the status panel.
- 2 Tap **e**.  
Your mobile device will automatically launch the eSIM installation screen.
- 3 Tap **SCAN**.

#### **Mobile device**

- 4 Use your mobile device to scan the QR code on the eSIM voucher.  
When the QR code is scanned, a profile is automatically downloaded on your device.
- 5 Tap **REGISTER**.

**Gear**

6 Tap ✓ to activate the eSIM on your Gear.

You can use the mobile data connection solely on the Gear.

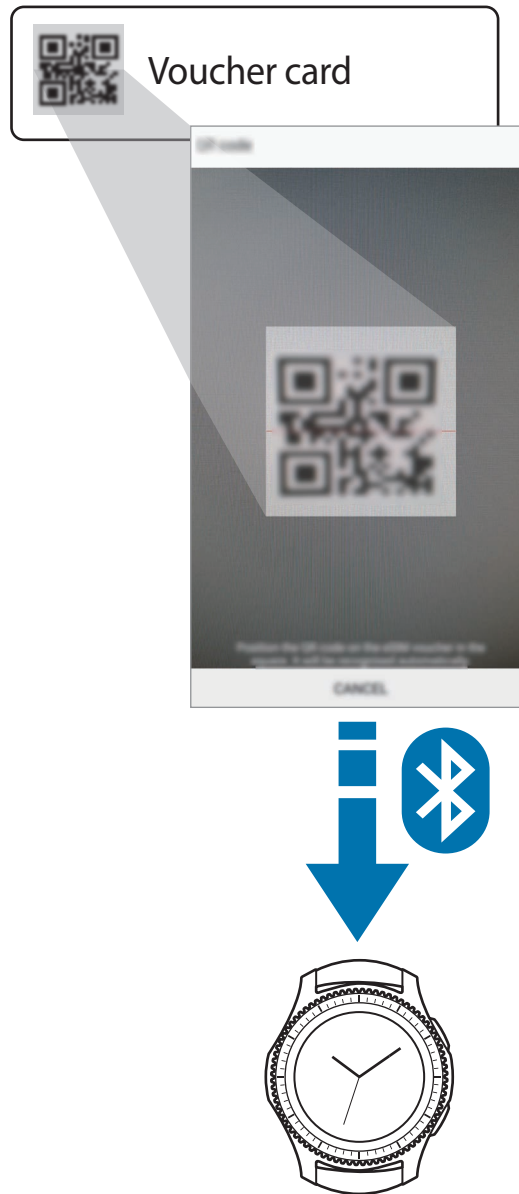

This QR code is an example. It is not for actual use.



## Managing the eSIM

To activate or deactivate the eSIM, open the Apps screen and tap  (Settings) → Gear info → About device → Gear eSIM profile, and then tap ✓.

To delete the eSIM, open the Apps screen and tap  (Settings) → Gear info → About device → Gear eSIM profile → Delete. The Gear will be reset and you can download a new profile. Before installing a new profile, you cannot use your Gear's mobile data connection.

To add a new profile, launch Samsung Gear on your mobile device, tap SETTINGS → Register Gear eSIM profile.

## Using the Gear without a mobile device

You can use the Gear without connecting it to a mobile device. You can set to use the Gear without a mobile device when you turn on the Gear for the first time or you reset it.



- Some features are not available.
- The setup method for using your Gear without a mobile device may vary depending on your model.

- 1 Turn on the Gear.
- 2 Tap , scroll down the screen, and tap **here**.
- 3 Select a language.
- 4 Read the on-screen instructions and tap ✓.
- 5 Read the terms and conditions, and then agree to them.
- 6 Follow the PIN setting instructions to protect your personal information.
- 7 Create a PIN to use when backing up and restoring data.
- 8 Set the date and time.



On the Gear, open the Apps screen, tap  (Settings) → Connect to phone → OK to connect the Gear to a mobile device while using the Gear without a mobile device.

# Basics

## Controlling the screen

### Screen composition

The Watch screen is the starting point for accessing all of the Gear's many screens.

You can view other screens by pressing the button, rotating the bezel, or swiping your finger on the screen.



Available widgets, notifications, and their arrangement may vary depending on the model and the software version.

### Adding widgets

You can add more widgets on the Home screen.

Scroll the screen, tap , and select a widget. The selected widget will appear in a new panel.

### Removing widgets

Tap and hold a widget and then tap .

## Turning the screen on and off

To turn on the screen, rotate the bezel. Or, press the Home key or the Back key.

To turn off the screen, cover it with your palm. Also, the screen will turn off if the Gear is not used for a specified period.

You can also turn on the screen using a gesture. On the Apps screen, tap  (**Settings**) → **Device** → **Wake-up gesture** and then tap the **Wake-up gesture** switch to activate it.

## Navigating the screen

### Switching between the Watch and Apps screen

To open the Apps screen, press the Home key on the Watch screen.

To return to the Watch screen, press the Home key.

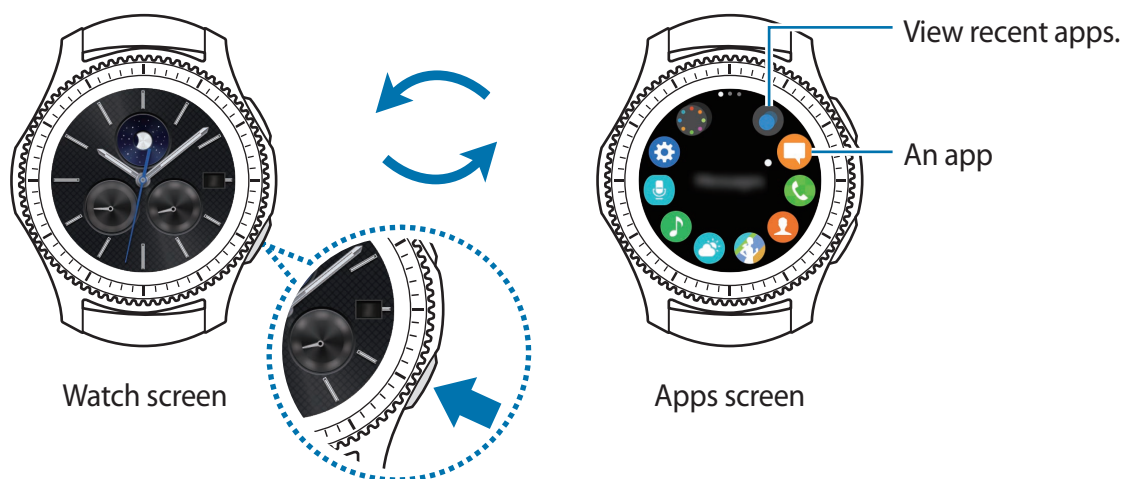

### Apps screen

The Apps screen displays icons for all apps.

To view other panels, rotate the bezel. You can also tap or swipe the screen to the left or right.





The available apps may vary depending on the model and the software version.

## Opening apps

On the Apps screen, tap an app icon to open the app.

To open an app from the list of recently used apps, tap  (**Recent apps**) on the Apps screen and select the recent app window.

## Closing apps

- 1 On the Apps screen, tap  (**Recent apps**).
- 2 Rotate the bezel to highlight the app you want to close.
- 3 Tap .

To close all running apps, tap **CLOSE ALL**.

## Returning to the previous screen

Press the Back key. You can also swipe down from the top edge of the screen.

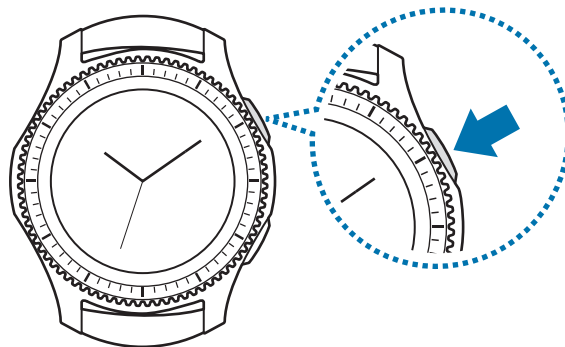

## Using the bezel

Rotate the bezel to easily control the Gear's various functions.



- Make sure the bezel area is free from the foreign materials.
- Do not use the bezel near magnetic fields as they may interfere with the bezel's internal magnets and cause it to malfunction.



If the bezel does not rotate, take it to a Samsung Service Centre. Do not disassemble the Gear.

## Scrolling through screens

Rotate the bezel to view other screens. On the Watch screen, rotate the bezel anticlockwise to view notifications.

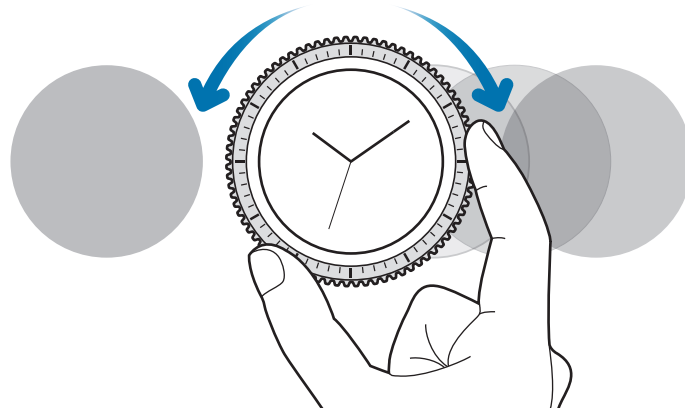

## Selecting an item

Rotate the bezel to highlight the item you want to select and then tap the item. When you rotate the bezel, the highlight indicator will move in the same direction.

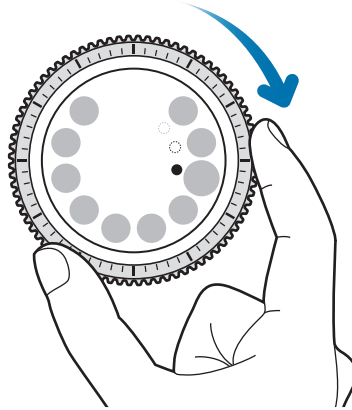

## Adjusting the input value

Rotate the bezel to adjust the volume or brightness. When adjusting the brightness, rotate the bezel clockwise to make the screen brighter.

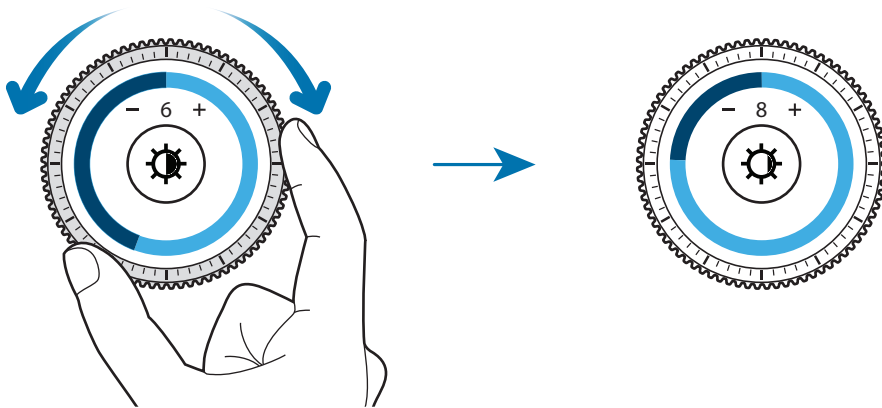

## Receiving or rejecting incoming calls

Rotate the bezel clockwise to receive an incoming call or to dismiss an alarm. Rotate the bezel anticlockwise to reject an incoming call or to activate the snooze feature for an alarm.

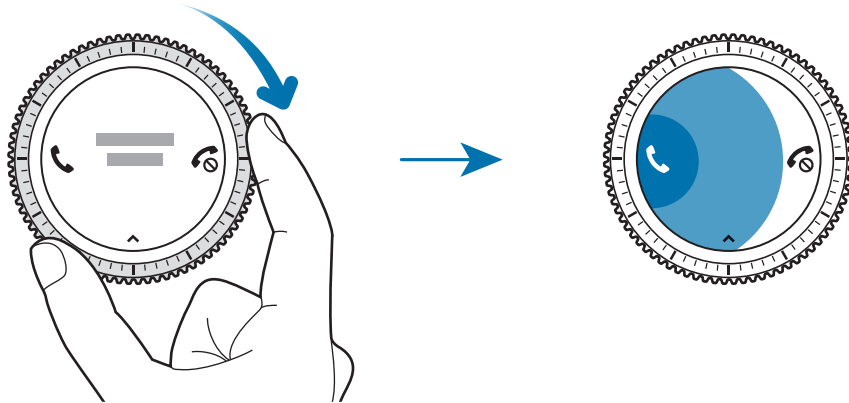

## Touchscreen



- Do not allow the touchscreen to come into contact with other electrical devices. Electrostatic discharges can cause the touchscreen to malfunction.
- To avoid damaging the touchscreen, do not tap it with anything sharp or apply excessive pressure to it with your fingertips.



The Gear may not recognise touch inputs close to the edges of the screen, which are outside of the touch input area.

## Tapping

To open an app, to select a menu item, or to press an on-screen button, tap it with your finger.

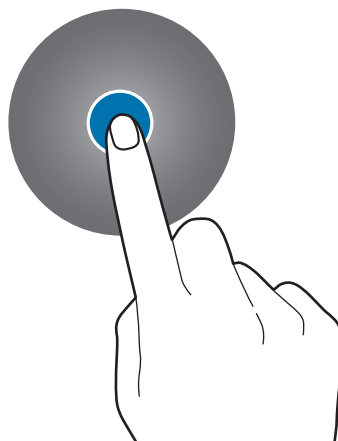

## Tapping and holding

Tap and hold the screen for two or more seconds to access the Edit mode or to view available options.

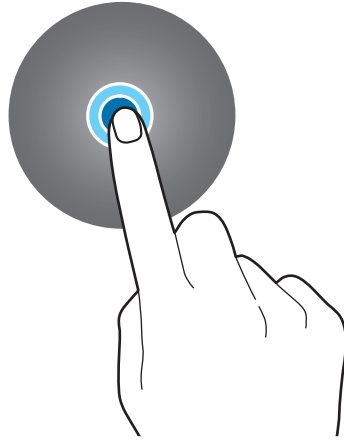

## Dragging

To move an item, tap and hold it and drag it to the target position.

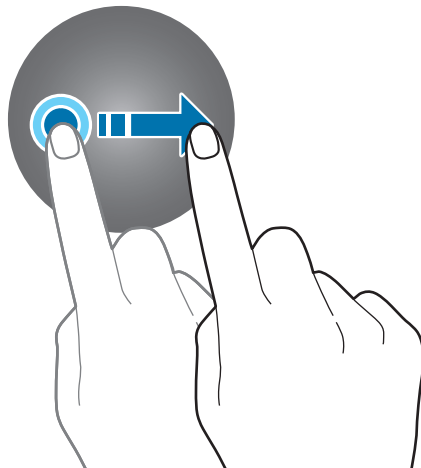



## Double-tapping

Double-tap on an image or text to zoom in. Double-tap again to return.

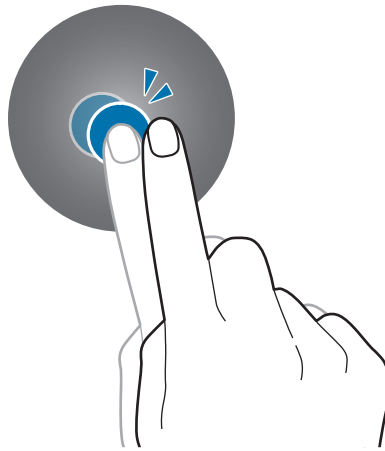

## Swiping

Swipe to the left or right to view other panels.

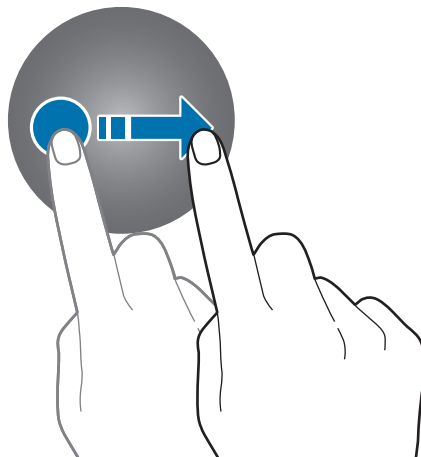

## Status panel

This panel allows you to view the current status and configure basic settings.

On the Watch screen, swipe downwards from the top edge of the screen.

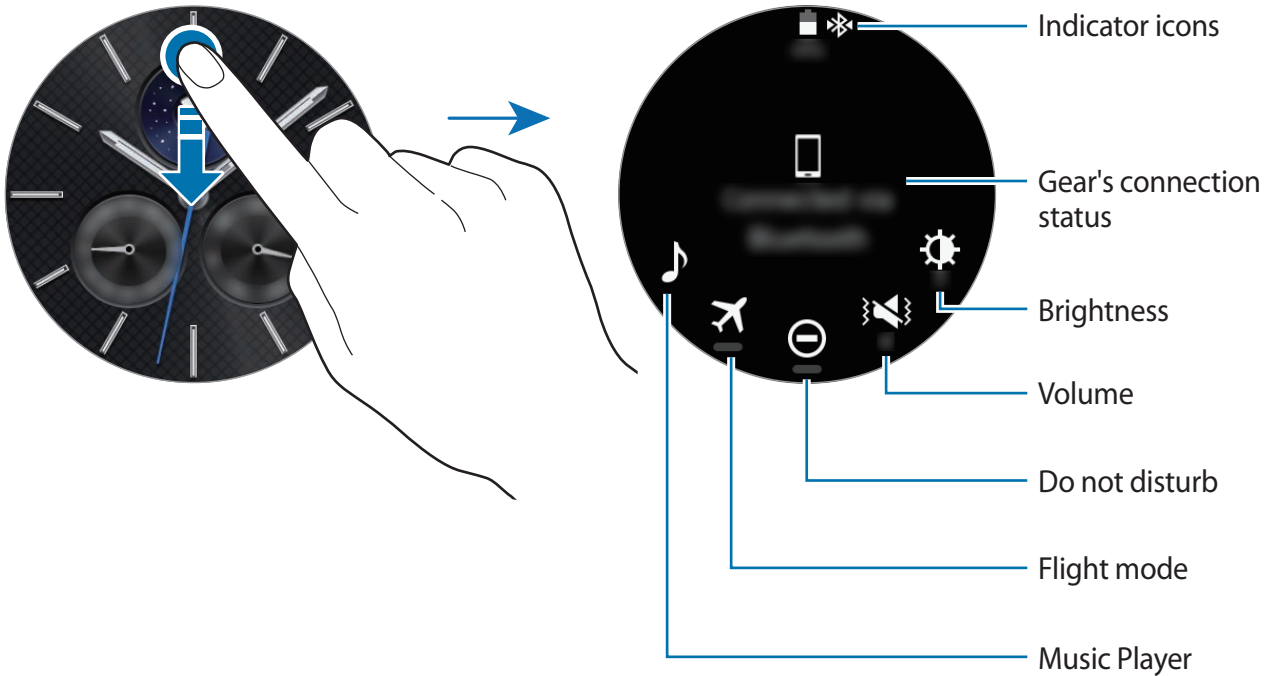

## Indicator icons

Indicator icons appear at the top of the screen. The icons listed in the table below are most common.



The indicator icons shown may vary depending on the region.

Icon	Meaning
	Bluetooth connected
	Bluetooth disconnected
	Signal strength
	Bluetooth headset connected
	HSDPA network connected
	LTE network connected
	Wi-Fi connected

Icon	Meaning
	HD voice feature activated
	Flight mode activated
	Battery power level

## Playing music

You can play music saved in the Gear or mobile device.

On the status panel, tap .

## Call forwarding

You can change the call forwarding settings.

On the status panel, tap .

Refer to [Forwarding calls to the Gear](#) for more information.

## Flight mode

You can activate or deactivate the flight mode.

On the status panel, tap .

The  icon will appear at the top of the Watch screen.

## Do not disturb mode

You can mute the Gear and set the screen not to turn on when a notification is received.

Alarms will still function normally.

On the status panel, tap .

The  icon will appear at the top of the Watch screen.

## Adjusting the volume

You can adjust the volume level for various sounds.

On the status panel, tap  and adjust the volume by rotating the bezel, or tap  or .

## Adjusting the brightness

You can adjust the Gear's display brightness to suit the environment.

On the status panel, tap  and adjust the brightness by rotating the bezel, or tap  or .

# Watch

## Watch screen

View the current time. When you are not on the Watch screen, press the Home key to return to the Watch screen.



## Changing the watch face

Tap and hold the Watch screen, scroll through the list and select a watch face. You can also customise the watch by tapping **STYLISE**. To download more watch faces from **Galaxy Apps**, tap **Get more watch faces**.

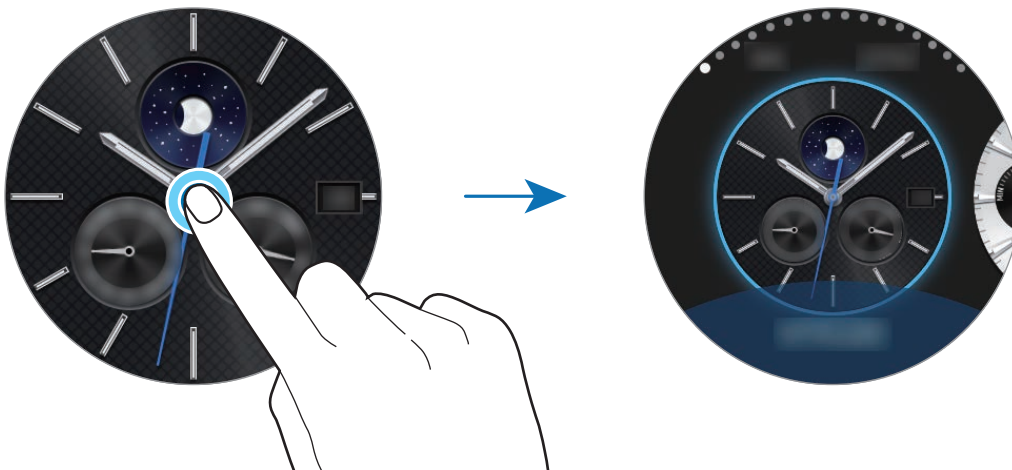

You can also change the Gear's watch face from your mobile device. Launch **Samsung Gear** on your mobile device and tap **SETTINGS** → **Watch faces**. To download more watch faces from **Galaxy Apps**, tap **INFO** → **VIEW MORE WATCH FACES**.

## Using the Watch always on feature

You can set the Gear to display the time when the screen is turned off.

On the Apps screen, tap  (Settings) → Style and tap the **Watch always on** switch to activate it.

## Power-off watch mode

When the Gear's battery is too low, it will ask you to activate Power-off watch mode to conserve battery power and continue working as a watch.

In Power-off watch mode, all the functions of the Gear are turned off, and the watch will display in power saving mode.

## Notifications

### Notification panel

Stay up to date with events, notifications, and messages from your mobile device and Gear.

On the Watch screen, rotate the bezel anticlockwise to open the notification panel. When there are unchecked notifications, a yellow dot will be visible on the screen.



## Viewing incoming notifications

When you receive a notification, information about the notification, such as its type, will appear on the screen. Tap the notification to view details.

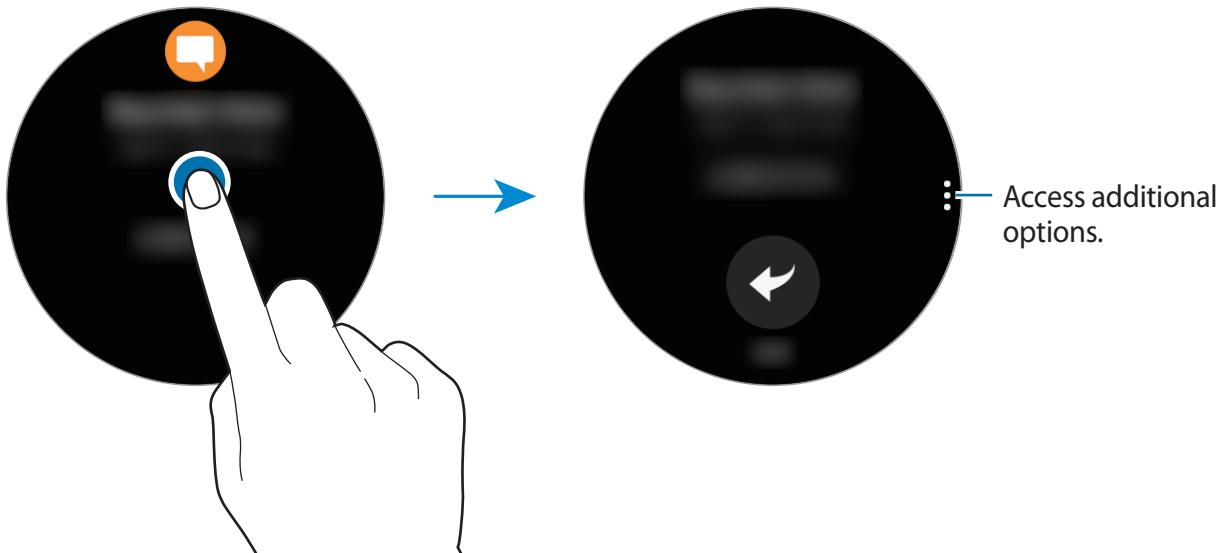

To view notifications received from other apps, rotate the bezel anticlockwise.

## Deleting notifications

Delete a notification by swiping upwards from the bottom edge of the screen while viewing a notification.

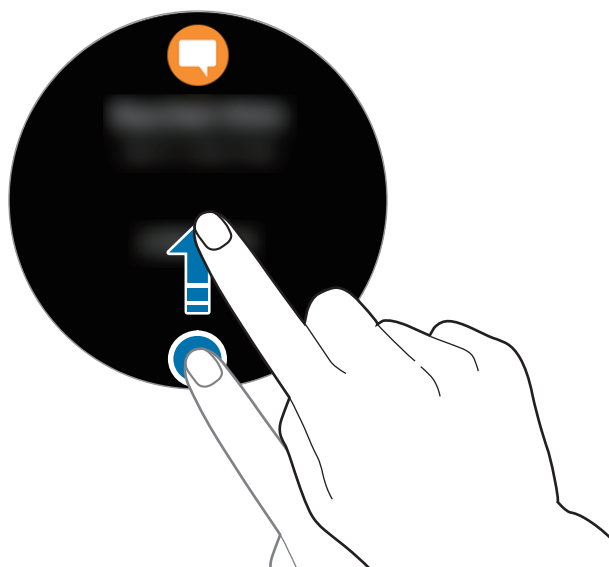

## Sending app notifications to the Gear

Set your mobile device to send app notifications to the Gear.

- 1 Launch **Samsung Gear** on your mobile device and tap **SETTINGS** → **Notifications**, and tap the switch.
- 2 Tap **Manage notifications** and tap the switch next to apps to receive notifications from them on your Gear.

## Entering text

### Introduction

A text input screen will appear when you are able to enter text.



- The screen layout may be different depending on the app you launch.
- When the Gear is connected to a mobile device via Bluetooth, the language settings applied on the mobile device are applied to the Gear.

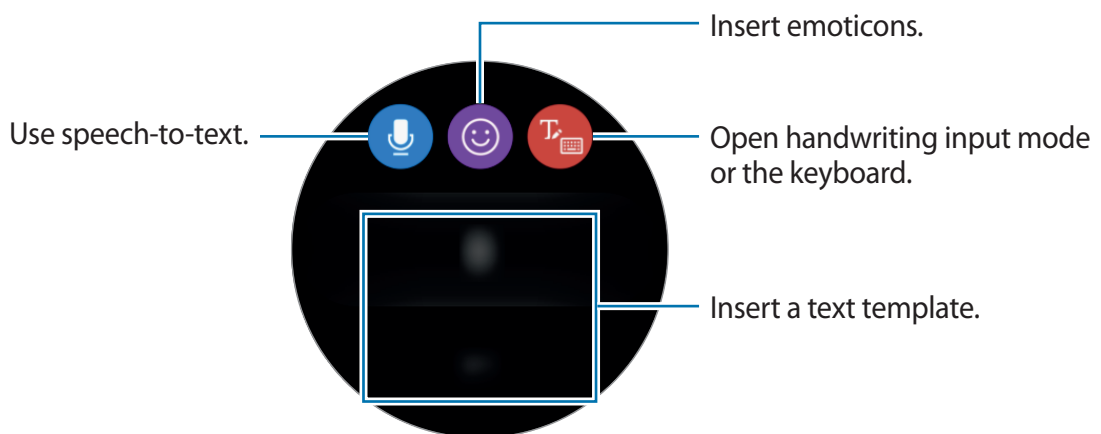

## Using the voice input

Tap  and speak to enter your message.

To change the language recognised, tap  → **Input languages**.



- This feature is not supported in some languages.

- **Tips for better voice recognition**

- Speak clearly.
- Speak in quiet places.
- Do not use offensive or slang words.
- Avoid speaking in dialectal accents.

The Gear may not recognise your spoken message depending on your surroundings or how you speak.

## Using emoticons

Tap  and select the emoticon you want to send. To draw a picture, tap **Doodle** at the top of the screen, and draw your message.

Rotate the bezel anticlockwise to delete the input stroke by stroke. To recover a stroke, rotate the bezel clockwise.

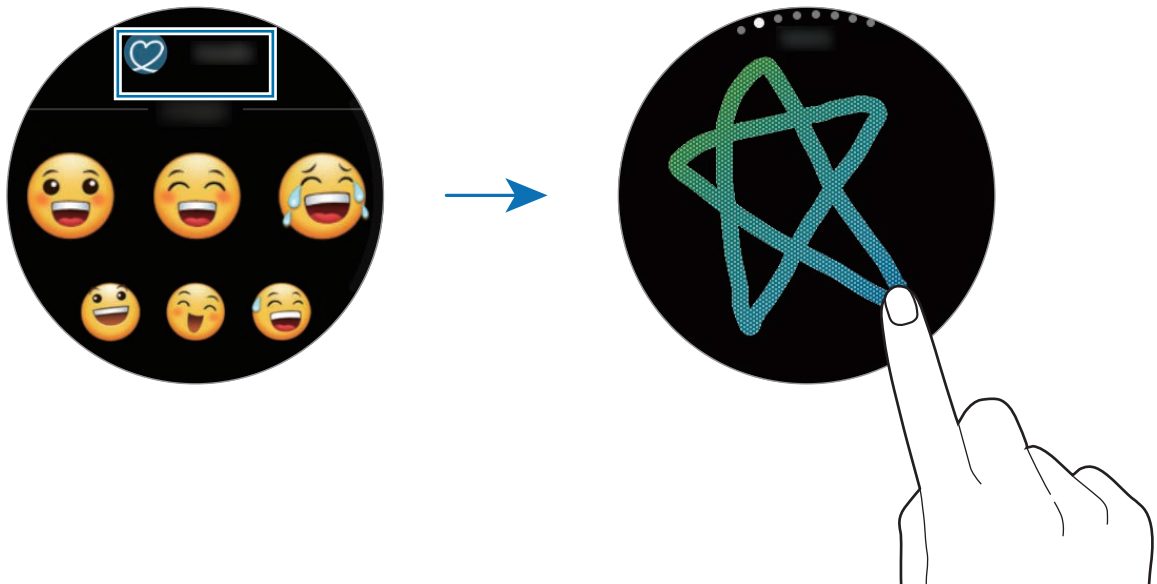



## Using handwriting input mode or the keyboard

Tap  and open handwriting mode and write on the screen.

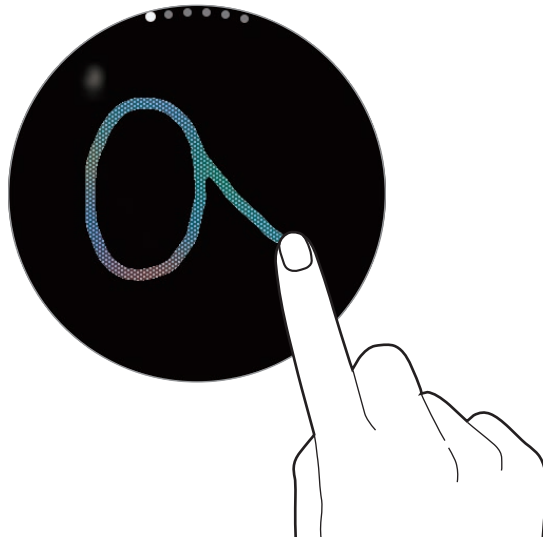

This feature may not be available depending on the region or service provider.

### Changing the input mode

Rotate the bezel to change the input mode. You can switch between handwriting mode, character mode, number mode, punctuation mode, emoticon mode, and voice input mode.

### Changing the input language

Slide the space key left or right.

To add more languages, switch to number mode, punctuation mode, or emoticon mode.

Then, tap  → **Select input languages** and select a language to add. You can use up to two languages.

## Using the keyboard

Rotate the bezel to enter text using the keyboard.



- Text entry is not supported in some languages. To enter text, you must change the input language to one of the supported languages.
- The keyboard layout may differ depending on the region.

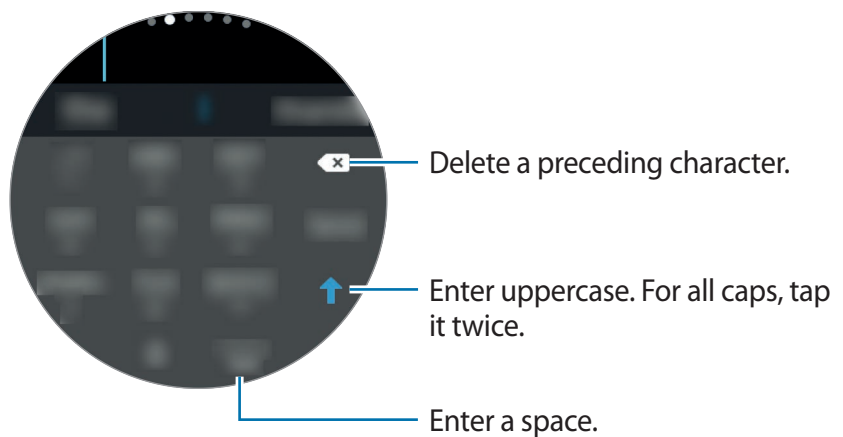

## GPS

The Gear has a GPS sensor so that you can check your real-time location information without connecting to a mobile device. You can also use apps which require your location information such as **Alti-Barometer**, and allow others to track your location by sending an SOS message in an emergency.

On the Apps screen, tap  (**Settings**) → **Connections** → **Location**, and tap the **Location** switch to activate it.

To select a method to use for locating, scroll down the screen and select an option.

When your Gear and mobile device are connected, this feature uses your mobile device's location information. Activate the mobile device's location feature to use the GPS sensor.



- GPS signal strength may decrease in locations where the signal is obstructed, such as between buildings or in low-lying areas, or in poor weather conditions.

## SOS messages

In an emergency situation, you can send an SOS message by quickly pressing the Gear's Home key three times. You can also set the Gear to automatically call your emergency contacts.

### Setting up SOS messages

- 1 Launch **Samsung Gear** on your mobile device and tap **SETTINGS** → **Send SOS requests**, and tap the switch to activate it.
- 2 Follow the on-screen instructions to add emergency contacts if you have not already done so.

### Adding emergency contacts

Launch **Samsung Gear** on your mobile device and tap **SETTINGS** → **Send SOS requests** → **Send SOS messages to** → **ADD**.

Tap **Create contact** and enter the contact information or tap **Select from Contacts** to add an existing contact as an emergency contact.

### Activating SOS calls

Set the Gear to automatically call your emergency contact after sending an SOS message. You can only call one of your emergency contacts.

Launch **Samsung Gear** on your mobile device and tap **SETTINGS** → **Send SOS requests**. Tap the **Make SOS calls to** switch to activate it and select an emergency contact.

### Setting the SOS message delay

Set the Gear to send an SOS message five seconds after you quickly press the Gear's Home key three times.

Launch **Samsung Gear** on your mobile device and tap **SETTINGS** → **Send SOS requests**. Tap the **Count down before sending** switch to activate it.

## Sending SOS messages

In an emergency situation, quickly press the Gear's Home key three times.

The Gear will send SOS messages to your emergency contacts. The messages will include your current location information and a link to track your real-time location information for 60 minutes.

If the **Make SOS calls to** feature is activated, the Gear will automatically call the selected emergency contact.

After sending an SOS message, the  icon will display on the Watch screen. Swipe to the right to view the result of your SOS request.

### Viewing my location

After sending an SOS message which includes your location information, you can view your location on the notification panel. On the Watch screen, swipe to the right to the notification panel and tap the screen to view your current location.



To finish sharing your location with your emergency contacts, scroll down the screen, and tap  → .

## Finding my Gear

If you misplace your Gear, use the Samsung Gear app on your mobile device to find it.

1 Launch **Samsung Gear** on your mobile device and tap **SETTINGS** → **Find My Gear**.

2 Tap .

The Gear will make a sound and the screen will turn on. Drag  outside the large circle on the Gear, or rotate the bezel clockwise, or tap  on the mobile device.

When your Gear is lost or stolen, you can control it remotely. Launch **Samsung Gear** on your mobile device and tap **SETTINGS** → **Find My Gear** → **Control remotely**, and tap the switch to activate it.

# Applications



## Messages

View messages and reply to using the Gear.

### Viewing messages



You may incur additional charges for receiving messages when you are roaming.

- 1 Tap  (**Messages**) on the Apps screen.  
Or, swipe to the right on the Watch screen when you receive a new message notification.
- 2 Scroll through the message list, and then select a contact to view your conversations.  
To view a message on your mobile device, tap , rotate the bezel and tap **Show on phone**.  
To reply to a message, tap  and enter your message.

### Sending messages



You may incur additional charges for receiving messages when you are roaming.

- 1 Tap  (**Messages**) on the Apps screen.

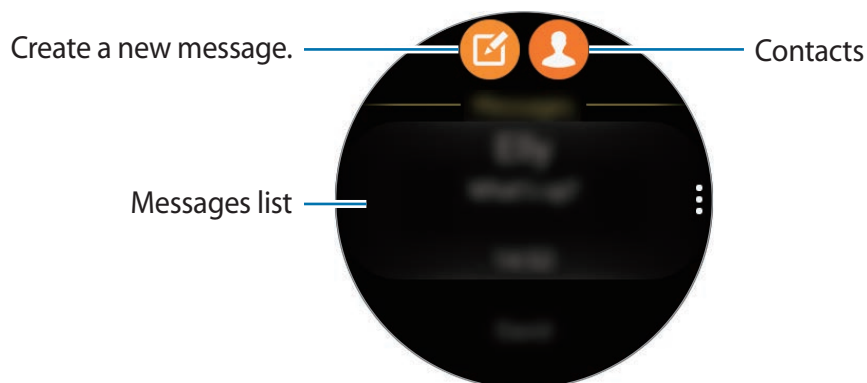

2 Tap .

Or, you can choose a message recipient by tapping  or selecting a contact from a contact on the messages list.

3 Add a recipient and tap **NEXT**.

4 Enter text using one of available methods and tap an icon to send the message.

When you select a text template or an emoticon, the message will automatically be sent to the recipients.

When you enter text by voice, you can select between text and audio for the message format. If the message format selection screen does not appear, open the Apps screen, tap  (**Settings**) → **Messages**, and tap the **Send as audio** switch to activate it.

## Phone

### Introduction

On your Gear, directly make or receive calls. You can have phone conversations via the internal microphone or a connected Bluetooth headset.



When your Gear is connected to a mobile network, you can make calls without being connected to a mobile device.

### Setting an outgoing number

Before making calls, you can select which device's number to make calls from. By default, outgoing calls are made from the mobile device's SIM card.

1 On the Apps screen, tap  (**Settings**) → **Connections** → **Mobile networks** → **Mobile networks** → **Always on**.

2 On the Settings screen, tap **Call** → **Outgoing number** → **Gear** or **Mobile device**.





- If you set the Gear as the outgoing number for calls, the battery will drain more quickly than normal.
- If a Bluetooth connection between the two devices is not available, outgoing calls will only be made from the Gear.

## Receiving calls

### Answering a call

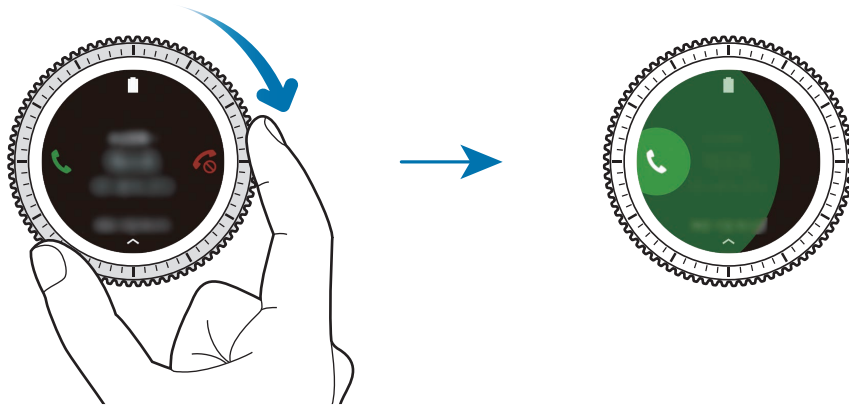
When a call comes in, drag  outside the large circle. Alternatively, rotate the bezel clockwise.



If the voice control feature is activated, say “Answer” to answer the call. To activate the voice control feature, open the Apps screen, tap  (**Settings**) → **Call** and tap the **Voice answer** switch.

You can have phone conversations via the internal microphone or a connected Bluetooth headset.

If you subscribe a call waiting, you can receive calls while you are on the phone. When you answer the second call, you can place the current call on hold or end it.

## Rejecting a call

Reject an incoming call and send a rejection message to the caller.

When a call comes in, drag  outside the large circle. Alternatively, rotate the bezel anticlockwise.

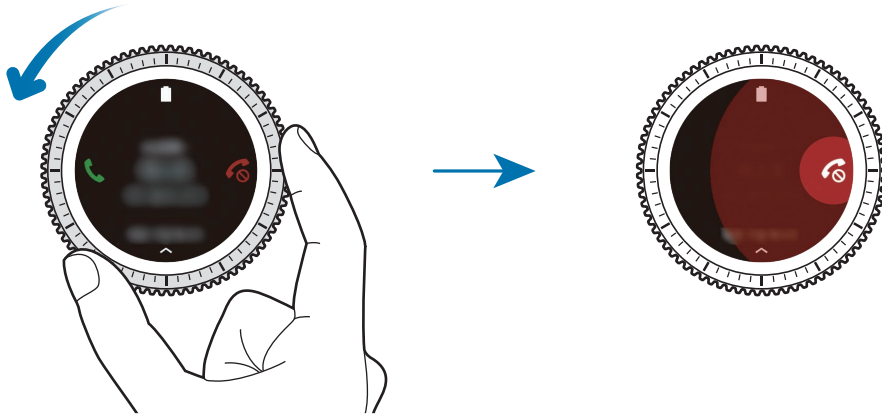

To send a message when rejecting an incoming call, swipe upwards from the bottom edge of the screen.

If the voice control feature is activated, say “Reject” to reject the call. To activate the voice control feature, open the Apps screen, tap  (**Settings**) → **Call** and tap the **Voice answer** switch.

## Missed calls

If a call is missed, a notification appears on the screen. On the Watch screen, rotate the bezel anticlockwise to view missed call notifications. Alternatively, tap  (**Phone**) on the Apps screen to view missed calls.





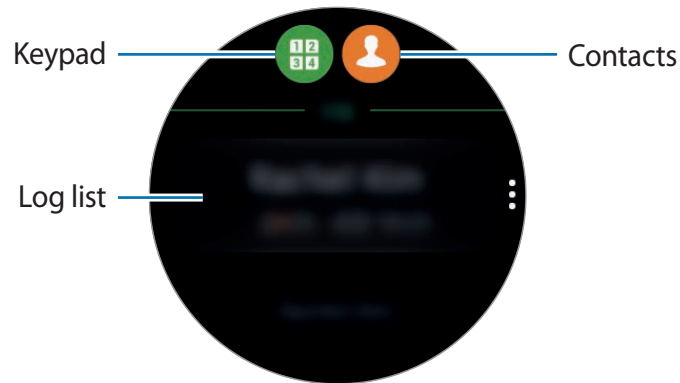

## Making calls

Tap  (Phone) on the Apps screen.



Use one of the following methods:

- Tap , enter a number using the keypad, and then tap .
- Tap , search or select a contact, and then tap .
- Scroll through the log list, select a log entry, and then tap .

## Options during calls

The following actions are available:

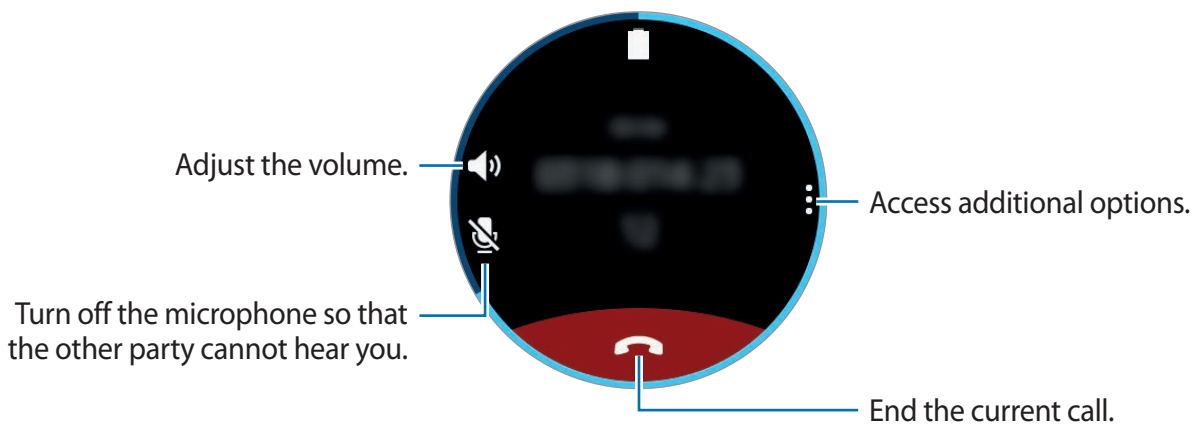

## Switching to a Bluetooth headset

Switch the Gear to a Bluetooth headset to continue the call on a Bluetooth headset.

Tap  → Headset.

## Transferring calls to the mobile device

You can continue calls on the mobile device.

Tap  → Phone.

## Opening the keypad

Tap  → Keypad.

## Forwarding calls to the Gear



When a Bluetooth connection between the two devices is not available, you cannot receive incoming calls to your mobile device's number on your Gear. Set the call forwarding feature to answer the calls to the mobile device's number on the Gear even when a Bluetooth connection between the devices is not available.

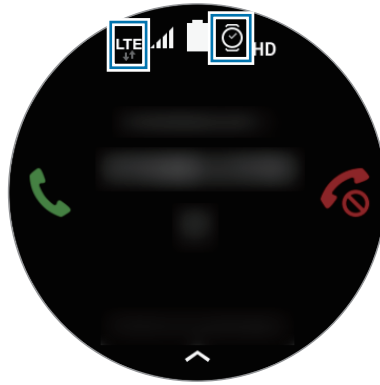

- This feature is only available when the Bluetooth connection between the two devices is disconnected.
- The method of activating this feature may differ depending on your service provider.
- A mobile device subscription may be required and you may incur additional charges to access this feature depending on the service provider.



<An incoming call diverted to the Gear from the mobile device>

- 1 Tap  (**Settings**) on the Apps screen.
- 2 Tap **Call** → **Auto call forwarding**.
- 3 Tap the **Enable** switch to activate the feature.
- 4 Enter your Gear's phone number and tap .

## Deactivating call forwarding

When the two devices are reconnected via Bluetooth, the call forwarding feature will be automatically deactivated.

To manually deactivate the call forwarding feature, on the Apps screen, tap  (**Settings**) → **Call** → **Auto call forwarding** → **Enable**.

## Setting call forwarding on the mobile device

When the two devices are connected remotely via your Samsung account, you can activate or deactivate the call forwarding feature on your mobile device.

Launch **Samsung Gear** on your mobile device and tap **SETTINGS** → **Auto call forwarding**.

## Contacts

View your mobile device's contacts list. You can make a call or send a message to the contact.

Tap  (**Contacts**) on the Apps screen.





- The favourites list contacts on the mobile device will display on the top of the contacts list.
- You can add contacts when your Gear is not connected to your mobile device.

Use one of the following search methods:

- Tap **Search** and enter the search criteria.
- Scroll through the contacts list.
- Rotate the bezel. When you rotate the bezel quickly, the list scrolls by the alphabet of the first letter.

Once a contact is selected, take one of the following actions:

-  : Make a voice call.
-  : Compose a message.

### Adding medical information to my profile

Add medical information to my profile for the rescuer to quickly see it in an emergency situation.

On your mobile device, tap **Contacts**, select your profile and enter your medical information. To view your medical information, on the Apps screen tap  (**Contacts**) → your profile and swipe upwards from the bottom edge of the screen.

In an emergency situation, press and hold the Gear's Home key (Power key) and tap **Emergency medical info**.



You may not use this feature depending on the mobile device that you connect to the Gear.

# S Health

## Introduction

S Health encourages you to have a healthy life by tracking your activity 24 hours a day and letting you set goals.

When you exercise for more than 10 minutes while wearing the Gear, it will display an encouraging message. When the Gear recognises inactivity for more than one hour, it will notify you and show you some stretching motions to follow.

Tap  (S Health) on the Apps screen.



- When running this app for the first time or after performing a data reset, tap **START**.
- S Health features are intended only for leisure, well-being, and fitness purposes. They are not intended for medical use. Before using these features, read the instructions carefully.
- Any information that is obtained from use of the Gear or the Fit Software or any application preloaded within may not be suitable, accurate, complete or reliable.

## Wearing the Gear correctly

When you activate the auto heart rate tracking feature, or when the Gear recognises your exercise, the Gear will automatically track your heart rate. When measuring your heart rate, wear the Gear snugly on your arm above your wrist as shown in the figure below. Do not fasten the Gear too tightly.

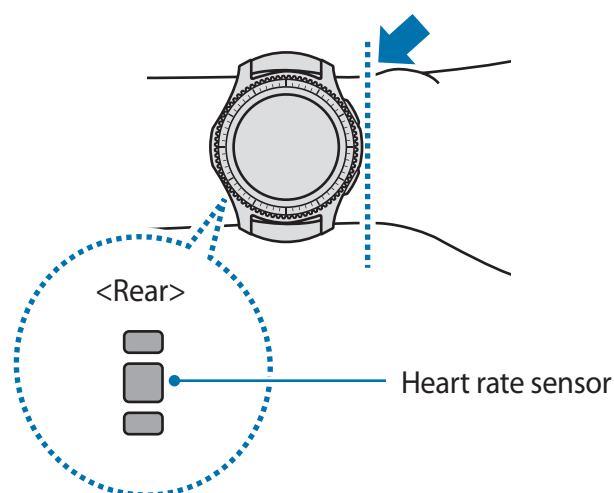



- The accuracy of the heart rate sensor may be diminished depending on measurement conditions and surroundings.
- Use the HR feature only for measuring your heart rate.
- Do not look directly at the heart rate sensor's lights. Doing so may impair your vision. Make sure children do not look directly at the lights.
- Cold ambient temperatures may affect your measurement; during winter or cold weather, keep yourself warm when checking your heart rate.
- Take heart rate measurements when you are seated and relaxed. Do not move your body while taking heart rate measurements. Doing so may cause your heart rate to be recorded inaccurately.
- If you receive a reading that is very different from your expected heart rate, rest for 30 minutes and then measure again.
- Smoking or consuming alcohol before taking measurements may cause your heart rate to be different from your normal heart rate.
- Do not talk, yawn, or breathe deeply while taking heart rate measurements. Doing so may cause your heart rate to be recorded inaccurately.
- Because the heart rate sensor uses light to approximate heart rate, its accuracy may vary due to physical factors that affect light absorption and reflection, such as blood circulation/blood pressure, skin condition and location and concentration of blood vessels. In addition, if your heart rate is extremely high or low, measurements may be inaccurate.
- Users with thin wrists may receive inaccurate heart rate measurements when the device is loose, causing the light to be reflected unevenly. If heart rate measurement is not working properly, adjust the position of the device's heart rate sensor to the right, left, up, or down on your wrist, or turn the device so the heart rate sensor sits firmly against the inside of your wrist.
- If the heart rate sensor is dirty, wipe the sensor and try again. Obstructions between the device's band and your wrist, such as body hair, dirt, or other objects may prevent the light from reflecting evenly. Please make sure you remove such obstructions before use.
- If your device becomes hot to the touch, remove it until it cools. Exposing skin to a hot surface of the device for a long time may cause skin burn.

## 24-hour Log

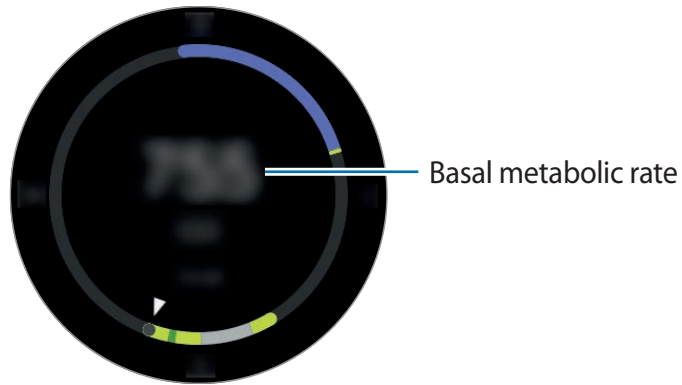

Based on your profile, you can view your basal metabolic rate (BMR) and activity for the day at a glance. You can also view your activity level and calories burned.

On the widget panel, select **24-hour Log** widget. Or, tap  (S Health) on the Apps screen.



Tap the screen and rotate the bezel to view the details of your activity log.



- **Healthy** (): It indicates whether you are walking or running. If you have made more than 100 steps per minute for at least 10 consecutive minutes, the Gear will encourage you to keep going.
- **Light** (): This indicates the time spent doing light activity, but not hard exercise or inactivity.
- **Inactive** (): This indicates the time spent not moving for one hour or more. To help you stay active, the Gear will prompt you to move after 50 minutes of inactivity.

## Steps

The Gear counts the number of steps you have taken and measures the distance travelled. On the widget panel, select **Steps** widget. Or, tap  (**S Health**) on the Apps screen, rotate the bezel clockwise, and open the steps tracker panel.

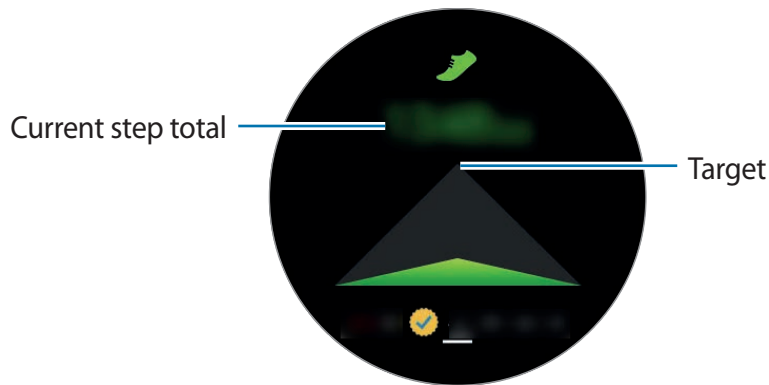

Tap the screen to view a graph of your step count records. To view records by day, rotate the bezel.



- You may experience a brief delay while the steps tracker monitors your steps and then displays your step count. You may also experience a brief delay before the pop-up window indicates that your goal has been reached.
- If you use the steps tracker while travelling by car or train, vibration may affect your step count.



## Floors

Record and track how many floors you climb.

- 1 Tap  (S Health) on the Apps screen.
- 2 Rotate the bezel clockwise and open the floors tracker panel.

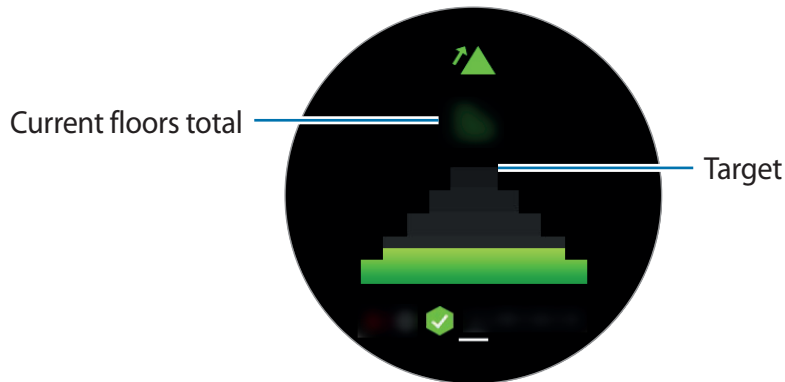

Tap the screen to view a graph of your climbing records. To view records by day, rotate the bezel.



- One floor is calculated as approximately 3 metres. The floors measured may not match the actual floors you climb.
- The floors measured may not be accurate depending on the environment, the user's movements, and the conditions of buildings.
- The floors measured may not be accurate if water or foreign materials enter the pressure relief vent (atmospheric pressure sensor). If there is any detergent, sweat, or raindrops on the Gear, rinse it with clean water and dry the pressure relief vent (atmospheric pressure sensor) thoroughly before use.

## Exercise

Record your exercise information and calories burned using S Health's exercise feature.



- Before using this feature, pregnant women, the elderly, and young children, users suffering from conditions, such as chronic heart disease or high blood pressure, are recommended to seek the advice of a licensed medical professional.
- If you feel dizzy, experience pain, or have difficulty breathing during exercise, stop using this feature and seek the advice of a licensed medical professional.





### **Be aware of following conditions before exercising in cold weather conditions:**

- Avoid using the device in cold weather. If possible, use the device indoors.
- If you use the device outside in cold weather, cover the Gear with your sleeves before using it.
- If you have just purchased or have reset the Gear, read the on-screen information about the app and create your profile.

## Setting the exercise

- 1 Tap  (S Health) on the Apps screen.
- 2 Rotate the bezel clockwise and open the exercise tracker screen.
- 3 Tap the screen and tap **Activity type** to select the type of exercise you want to monitor.
- 4 Tap **Target** to select a target type.
- 5 Set the target.

## Exercising with the Gear



- 1 Tap  (**S Health**) on the Apps screen.
  - 2 Rotate the bezel clockwise and open the exercise tracker screen.
  - 3 Tap  to start exercising.
-  • Tap  to allow this app to use your location information while exercising. Your location information sharing preference will be saved as the default.
  - To set your exercise again, tap the exercise tracker screen.

You can view exercise information, such as calories burned and current speed, when you rotate the bezel or tap the bottom of the screen.

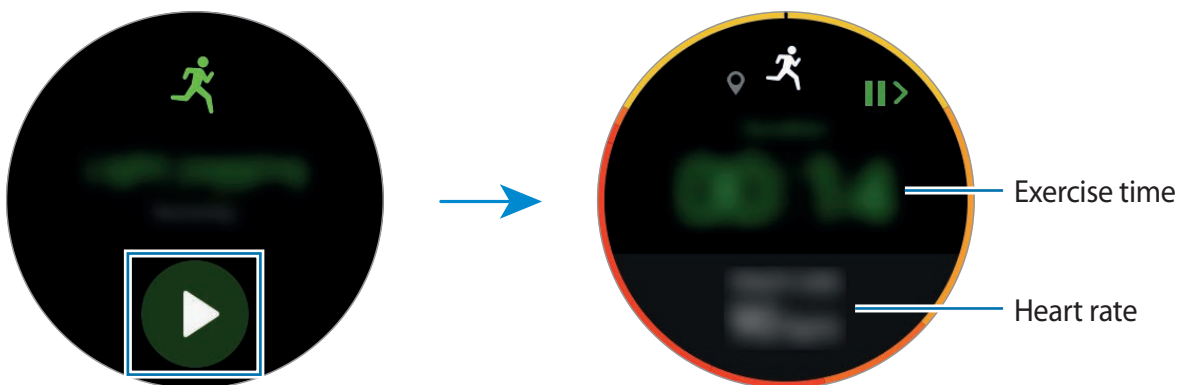
To listen to music, rotate the bezel anticlockwise.



- 4 To finish exercising, press the Back key and tap **FINISH** → .

 The music will continue to play even if you finish exercising. Stop playing music before finish exercising. Or, launch  (**Music Player**) to stop playing music.

## Automatic exercise recognition

Once you have exercised for 10 minutes while wearing the Gear, it automatically recognises that you are exercising and records the exercise type and duration.

When you stop exercising for more than one minute, the Gear automatically recognises that you have stopped exercising and this feature is deactivated.



- Among the various exercise types, only walking, running, elliptical workouts, rowing, and cycling can be measured.
- The automatic exercise recognition feature measures the distance travelled and calories burnt using the acceleration sensor. The measurements may not be accurate depending on your walking and exercise routines.

## Heart rate

Measure and record your heart rate.





- The Gear's heart rate tracker is intended for fitness and informational purposes only and is not intended for use in the diagnosis of disease or other conditions, or in the cure, mitigation, treatment, or prevention of disease.
- To measure your heart rate more accurately with the Gear, wear the Gear firmly around your lower arm just above the wrist. Refer to [Wearing the Gear correctly](#) for details.

### **Be aware of following conditions before measuring your heart rate:**

- Rest for 5 minutes before taking measurements.
- If the measurement is very different from the expected heart rate, rest for 30 minutes and then measure it again.
- During winter or in cold weather, keep yourself warm when measuring your heart rate.
- Smoking or consuming alcohol before taking measurements may cause your heart rate to be different from your normal heart rate.
- Do not talk, yawn, or breathe deeply while taking heart rate measurements. Doing so may cause your heart rate to be recorded inaccurately.
- Heart rate measurements may vary depending on the measurement method and the environment they are taken in.
- If the heart rate sensor is not working, check the Gear's position on your wrist and make sure nothing is obstructing the sensor. If the heart rate sensor continues to have the same problem, visit a Samsung Service Centre.

## Measuring your heart rate

- 1 Tap  (S Health) on the Apps screen.
- 2 Rotate the bezel clockwise and open the heart rate tracker screen.
- 3 Tap  to begin measuring your heart rate.  
After a moment, your current heart rate will be displayed on the screen.

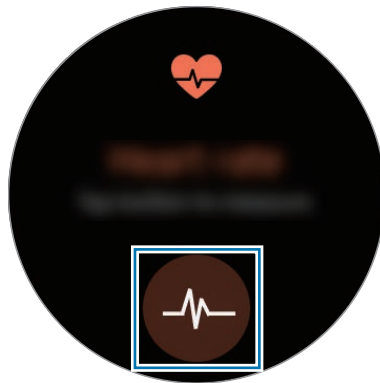

Tap the screen to view a graph of your records. To view records by hour, rotate the bezel.

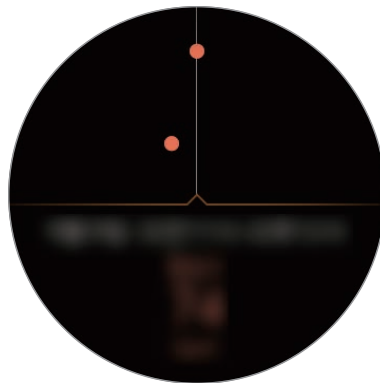

## Tracking your heart rate

The Gear can automatically measure and track your heart rate. Your Gear will measure your heart rate at regular intervals. This feature may not function properly while you are moving. Your heart rate is automatically measured when you are using the Exercise app.

To track your heart rate, rotate the bezel clockwise and open the settings screen. Then, tap  → **Auto HR** and tap the **Auto HR** switch to activate it.

## Water

Record and track how many glasses of water you drink.

- 1 Tap  (S Health) on the Apps screen.
- 2 Rotate the bezel clockwise and open the water tracker screen.



- 3 Tap  when you drink a glass of water.

If you accidentally added an incorrect value, you can fix it by tapping .

Tap the screen to view a graph of your records. To view records by day, rotate the bezel.

## Caffeine

Record and track how many cups of coffee you drink.

- 1 Tap  (S Health) on the Apps screen.
- 2 Rotate the bezel clockwise and open the caffeine tracker screen.



3 Tap **+** when you drink a cup of coffee.

If you accidentally added an incorrect value, you can fix it by tapping **-**.

Tap the screen to view a graph of your records. To view records by day, rotate the bezel.

## Together

Compare your step count records with other S Health users. You can set a goal, compete with your friends, and view the challenge status.

Activate the together feature in the S Health app on your mobile device.

1 Tap  (S Health) on the Apps screen.

2 Rotate the bezel clockwise and open the together screen.

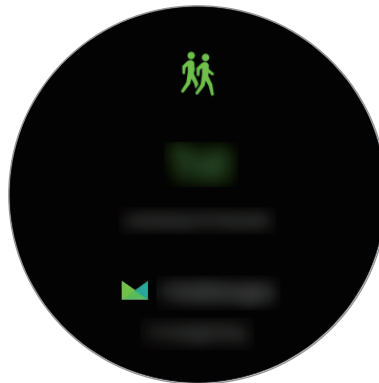

Tap the screen to view the challenge status and the leaderboard.

## Additional information

- The purpose for such data collection is limited to providing the service that you have requested, including providing additional information to enhance your wellness, back up/sync data, data analysis and statistics or to develop and provide better services. (But if you sign in to your Samsung account from S Health, your data may be saved on the server for data backup purposes.) Personal information may be stored until the completion of such purposes. To delete any data you have shared with social networks or transferred to storage devices, you must delete them separately.
- You assume full responsibility for the inappropriate use of data shared on social networks or transmitted to others. Use caution when sharing your personal data with others.
- If the Gear is connected to a mobile device, verify the communication protocol to confirm proper operation. If you use a wireless connection, such as Bluetooth, the Gear may be affected by electronic interference from other devices. Avoid using the Gear near other devices that transmit radio waves.
- The content used in the S Health app may vary depending on the software version of the app. The services provided with the app are subject to change or the cancellation of support without prior notice.
- Available S Health functions and services may vary depending on the local laws and regulations in your region.
- Some functions of S Health may not be provided depending on your region.
- S Health functions are intended for fitness and informational purposes only and is not intended for use in the diagnosis of disease or other conditions, or in the cure, mitigation, treatment, or prevention of disease.



- Measured distance may differ from the actual distance due to uneven strides, walking in place, and pacing around.
- Only records from the past thirty days are saved. You can view previous data on the mobile device where the S Health app is installed.



## Alti-Barometer

Measure the altitude and atmospheric pressure of your current location using the internal atmospheric sensor.

On the Apps screen, tap  (**Alti-Barometer**). To view the barometer, swipe to the left.



Altimeter



Barometer

### Measuring your altitude

Measure your current altitude and view a graph of changes over the last 6 hours.

On the Apps screen, tap  (**Alti-Barometer**).



- If you have recently purchased or reset the Gear, tap **GO** to activate the Gear's GPS feature.
- The altitude measured may not be accurate if water or foreign materials enter the pressure relief vent (atmospheric pressure sensor). If there is any detergent, sweat, or raindrops on the Gear, rinse it with clean water and dry the pressure relief vent (atmospheric pressure sensor) thoroughly before use.

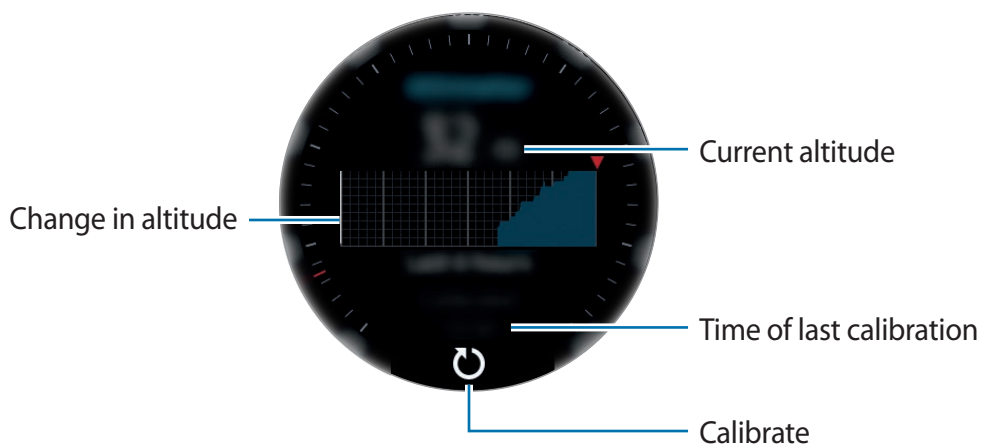

## Manually calibrating the altitude

You can manually calibrate the measured altitude.

- 1 Swipe to the left to open the settings screen.
- 2 Tap **CHANGE >**.
- 3 Tap **Manual calibration** and tap the **Manual calibration** switch to activate it.
- 4 Tap **Altitude** and set the reference value.

The altitude is calibrated based on the entered reference value.

## Measuring the atmospheric pressure

Measure the current atmospheric pressure and view a graph of changes over the last 6 hours. You can anticipate any changes to the weather using the pressure prediction gauge.

- 1 On the Apps screen, tap  (**Alti-Barometer**).
- 2 Swipe to the left to open the barometer screen.



The atmospheric pressure measured may not be accurate if water or foreign materials enter the pressure relief vent (atmospheric pressure sensor). If there is any detergent, sweat, or raindrops on the Gear, rinse it with clean water and dry the pressure relief vent (atmospheric pressure sensor) thoroughly before use.

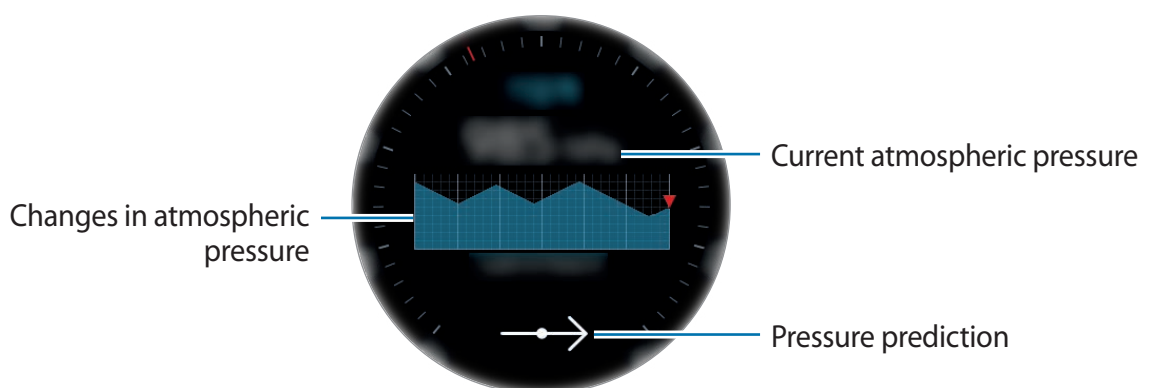

## Manually calibrating the atmospheric pressure

You can manually calibrate the measured atmospheric pressure.

- 1 Swipe to the left to open the settings screen.
- 2 Tap **CHANGE >**.
- 3 Tap **Manual calibration** and tap the **Manual calibration** switch to activate it.
- 4 Tap **Sea level pressure** and set the reference value.

The atmospheric pressure is calibrated based on the entered reference value.

## Configuring the alti-barometer

Scroll the screen to open the settings screen and tap **CHANGE >** to use the following options.

- **Manual calibration:** Calibrate the altimeter and the atmospheric pressure based on the entered reference value.
- **Pressure alerts:** Set to notify you of rapid changes of atmospheric pressure.
- **Distance unit:** Change the height unit.
- **Pressure unit:** Change the pressure unit.
- **Help:** View information about using the alti-barometer.

# Music Player

## Introduction

Listen to music saved in the Gear and in the mobile device.

## Playing music

Tap  (**Music Player**) on the Apps screen.

To open the playlist, swipe upwards from the bottom edge of the screen.

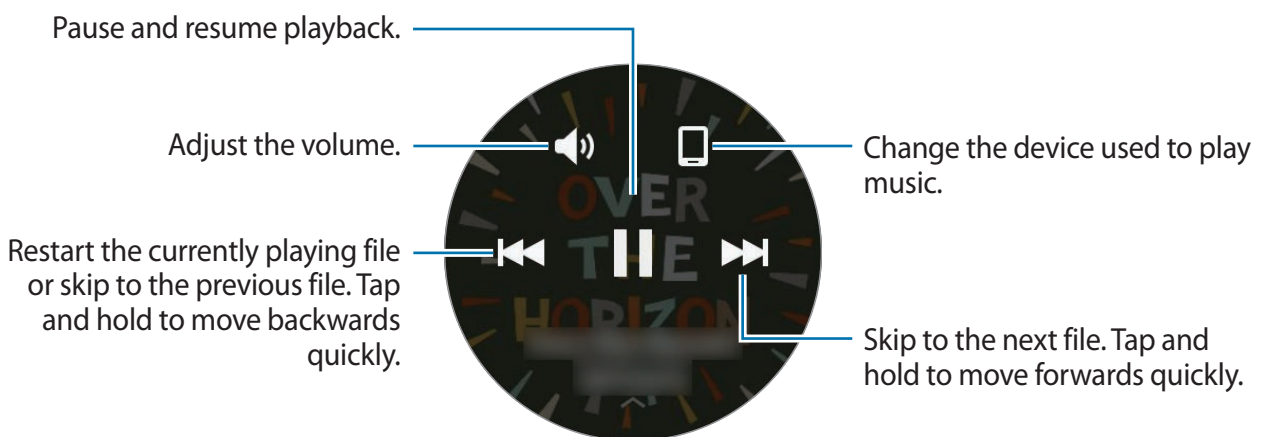

## Importing music





Import music saved in your device to your Gear.

- 1 Launch **Samsung Gear** on your mobile device.
- 2 Tap **SETTINGS** → **Send content to Gear**.
- 3 Tap **Select tracks**.
- 4 Select files and tap **DONE**.

To sync music in your mobile device with your Gear, tap the **Auto sync** switch under **Music**. The music in your mobile device will be synced with your Gear when it is charging and when it has more than 15 % of remaining battery power.

## Playing music on the Gear

Play music saved in your Gear via the internal speaker. You can also play music via a connected Bluetooth headset.

- 1 Tap  (Music Player).
- 2 Tap  to play the music saved in your Gear.  
The icon will be changed to .
- 3 Tap .





## Playing music via a Bluetooth headset

You can listen to music saved in the Gear via a Bluetooth headset.

Tap , rotate the bezel, and tap **Listen via BT**. Select a headset from the detected devices list.

## Playing music from your mobile device

Play music saved on your mobile device and control it with your Gear.

- 1 Tap  (Music Player).
- 2 Tap  to play the music saved in your mobile device.  
The icon will be changed to .
- 3 Tap .

## Standalone music

Listen to music or radio using the Gear by itself. You must download music or a radio streaming app on the Gear.

On the Apps screen, tap  (Get more apps) → **Show on phone**. Browse and download music or a radio streaming app in **Galaxy Apps**.

## Reminders

Add reminders for events such as buying tickets, going to the laundromat, or taking medicine, without using your calendar app. You can set alarms to receive reminders at specified times.

### Creating a reminder

- 1 On the Apps screen, tap  (**Reminders**).
- 2 Tap **Create reminder**.  
If you have a saved reminder, tap **Create** on the list.
- 3 Speak to create a reminder. When you are finished, tap **DONE**.  
Or, tap **KEYBOARD** > to enter text and tap **Done**.
- 4 To set an alarm, tap **SET TIME** >, set the alarm time by rotating the bezel, and then tap **DONE**.
- 5 Tap **SAVE**.

### Viewing the reminder alarm

When an alarm sounds, tap the notification to view the reminder details.

You can also rotate the bezel anticlockwise on the Watch screen to view reminders.



- To delete a reminder or to use the snooze function, tap .
- You can view all your reminders, including deleted reminders, in the **Reminders** app.

### Completing or deleting the reminder

When you have finished your task, you can set the reminder as completed or delete it.

On the reminder's details, tap  to complete it.

To delete it, tap , rotate the bezel, and tap **Delete**.

## Schedule

View the events scheduled on the mobile device.

- 1 Tap  (**Schedule**) on the Apps screen.
- 2 Tap anywhere on the monthly calendar.  
The current day's events list will be shown.
- 3 To view upcoming events, rotate the bezel to clockwise.

## S Voice

### Introduction

Perform various tasks simply by speaking.



Make sure the Gear's microphone is not obstructed when you are speaking into it.

### Setting a wake-up command

You can launch  (**S Voice**) using your own wake-up command. You can only use this feature when your Gear's screen is turned on.

To change the wake-up command, tap , rotate the bezel and tap **Set wake-up command**.

## Using S Voice

- 1 Say the preset wake-up command. Alternatively, tap **S Voice** on the Apps screen.  
When  (**S Voice**) is launched, the Gear begins voice recognition.



This app may not be available depending on the region or service provider.

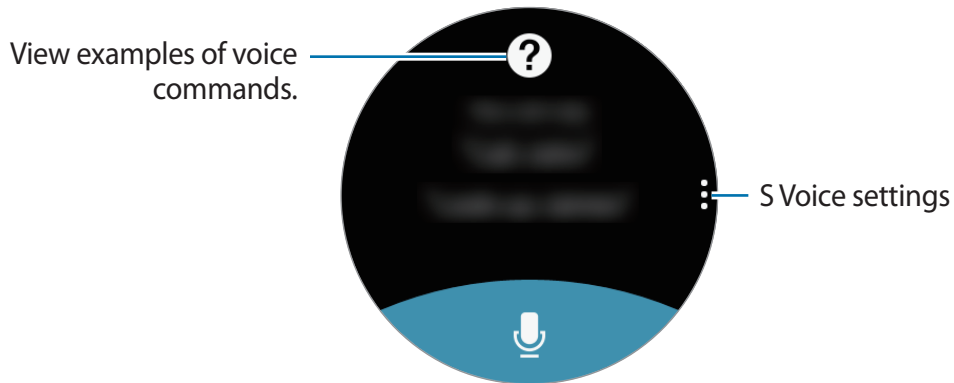

- 2 Say a voice command.  
If the Gear recognises the command, the Gear will perform the corresponding action.  
To repeat a voice command or say a different command, tap .



### Tips for better voice recognition

- Speak clearly.
- Speak in quiet places.
- Do not use offensive or slang words.
- Avoid speaking in dialectal accents.

The Gear may not recognise your commands or may perform unwanted commands depending on your surroundings or how you speak.



## Setting the language

On the Apps screen, tap  (**S Voice**) → , rotate the bezel, tap **Language**, and then select a language.



The selected language is applied to **S Voice** only, not to the language displayed on the Gear.

## Weather

View weather information on the Gear for locations set on the mobile device when the devices are connected.

Tap  (**Weather**) on the Apps screen.

To view the current day's weather information, tap the screen and rotate the bezel.

To add other cities' weather information, rotate the bezel clockwise.

## Alarm

Set alarms and manage them. When an alarm is set on your connected mobile device, your Gear will also alert you.

### Setting alarms

- 1 Tap  (**Alarm**) on the Apps screen.
- 2 Tap **Add alarm**.  
If you have a saved alarm, tap **Add** on the alarms list.
- 3 Set the alarm time by rotating the bezel and tap **NEXT**.
- 4 Select the days for the alarm to repeat and tap **NEXT**.

5 Select an alarm notification type and tap **SAVE**.

The saved alarm is added to the alarms list.

On the alarms list, tap  to activate the alarm or tap  to deactivate the alarm.

## Stopping alarms

Drag **X** outside the large circle to stop an alarm. Alternatively, rotate the bezel clockwise.

If you want to use the snooze function, drag **ZZ** outside the large circle to repeat the alarm after 5 minutes. Alternatively, rotate the bezel anticlockwise.

## Deleting alarms

In the alarms list, tap and hold an alarm, and then tap **DELETE**.

# World Clock

## Creating clocks

1 Tap  (**World Clock**) on the Apps screen.

2 Tap **Add city**.

If you have a saved world clock, tap **Add** on the clocks list.

3 Rotate the bezel to select a time zone on the globe.

You can also tap **ALL CITIES >** and search for a city or select a city from the list.

4 Tap the city name representing the selected time zone.

5 Rotate the bezel to the city you want and tap it.

## Deleting clocks

On the clocks list, tap and hold a clock, and then tap **DELETE**.

# Gallery



## Importing and exporting images

### Importing images from your mobile device

- 1 Launch **Samsung Gear** on your mobile device.
- 2 Tap **SETTINGS** → **Send content to Gear**.
- 3 Tap **Select photos**.
- 4 Select files and tap **DONE**.

To sync images in your mobile device with your Gear, tap the **Auto sync** switch under **Photo**, tap **Albums to sync**, and then select albums to import to the Gear. The selected albums will be synced with your Gear when it is charging and when it has more than 15 % of remaining battery power.

### Exporting images to your mobile device

- 1 Tap  (**Gallery**) on the Apps screen.
- 2 Tap an image.
- 3 Tap and hold the image to export.
- 4 Rotate the bezel and select any images to export.
- 5 Tap  → **Send to phone**.

You can view the exported images in Gallery app on your mobile device.

## Viewing images



- 1 Tap  (**Gallery**) on the Apps screen.
- 2 Rotate the bezel to scroll through the image list and select an image.

## Zooming in or out

While viewing an image, double-tap the image to zoom in or out.



When an image is magnified, you can view the rest of the image by scrolling around the screen.

## Deleting images

- 1 Tap  (**Gallery**) on the Apps screen.
- 2 Tap an image.
- 3 Tap and hold an image to delete.
- 4 Rotate the bezel and select any images you want to delete.
- 5 Tap **DELETE** → .





## News Briefing

View the latest articles in various categories. You can catch up on news categories that interest you.

- 1 Tap  (**News Briefing**) on the Apps screen.
- 2 Rotate the bezel to select an article from a specific category.  
To edit categories, tap ; rotate the bezel, tap **Select topic**, and then tick categories.
- 3 Tap an article to read it.  
To read the full article, tap  and read it on your mobile device.

## Find My Phone

If you misplace the mobile device, the Gear can help you find it.

- 1 Tap  (**Find My Phone**) on the Apps screen.
- 2 Tap .  
The mobile device emits sounds and turns on the screen.  
Drag  outside the large circle on the mobile device, or tap  on the Gear.

### Viewing the location of your mobile device

Tap ; rotate the bezel, and tap **Locate phone**.

The Gear will display your mobile device's location.

## Email

View emails received on the mobile device and reply to them.

### Reading emails

1 On the Apps screen, tap  (**Email**).

2 Select an email to open the email screen.

To view an email on the mobile device, tap , rotate the bezel, and tap **Show on phone**.

To reply to a message, tap  and enter your message.



You may not be able to reply emails depending on the mobile device that you connect to the Gear.

## Get more apps

Download specialised apps on your Gear, not through the connected mobile device.

On the Apps screen, tap  (**Get more apps**). Scroll through the list and select an app to download.

Tap **Show on phone** to launch **Galaxy Apps** on your mobile device. Then, browse and select an app to download.

# Settings

## Introduction

Customise settings for functions and apps. You can make your Gear more personalised by configuring various setting options.

Tap  (**Settings**) on the Apps screen.

## Style

Customise the watch face and the Apps screen.

On the Settings screen, tap **Style**.

- **Watch faces:** Select a watch type. You can also select items to display on the watch face and download more watch faces from **Galaxy Apps**.
- **Watch always on:** Set the Gear to display a watch when the screen is turned off.



This feature only works while you are wearing the Gear.

- **Notification indicator:** Set the Gear to display a yellow dot on the Watch screen to alert you to notifications that you have not checked.
- **Background style:** Change the Apps screen's wallpaper.
- **Font:** Change the font type and size.

## Sounds and vibration

Change settings for various sounds.

On the Settings screen, tap **Sounds and vibration**.

- **Sound mode:** Set the Gear to use sound mode or silent mode.
- **Vibrate with sound:** Set the Gear to vibrate and play a ringtone for incoming calls and notifications.
- **Volume:** Adjust the volume level for various sounds.
- **Vibration intensity:** Adjust the force of the vibration notification.

- **Long buzz:** Set the Gear to vibrate longer for incoming calls and notifications.
- **Ringtones:** Change the ringtone.
- **Ringtone vibration:** Select a vibration pattern for incoming calls.
- **Notification sound:** Change the notification ringtone.
- **Notification vibration:** Select a vibration pattern for notifications.
- **Touch sounds:** Set the Gear to make a sound when apps or options are selected on the touchscreen.

## Device

Change the Gear's interaction settings.

On the Settings screen, tap **Device**.

- **Double press Home key:** Select an action to perform when you press the Gear's Home key twice.
- **Wake-up gesture:** Set the Gear to turn on the screen when you raise your wrist that is wearing the Gear.

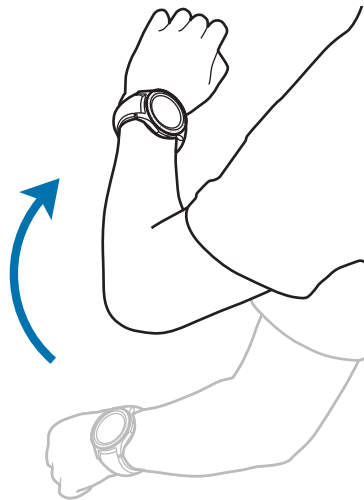



- **Touch sensitivity:** Set the Gear to allow use of the touch screen with gloves on.
- **Do not disturb:** Set the device to mute incoming calls and notification sounds.
- **Auto open apps:** Set the Gear to automatically open an app when it is highlighted.
- **Date and time:** Set the Gear's date and time when it is not connected to the mobile device.
- **Language:** Select the Gear's display language.



The **Date and time** and **Language** options are available when your Gear is not connected to your mobile device.

## Display

Change the display settings.

On the Settings screen, tap **Display**.

- **Brightness:** Adjust the brightness for the display.
- **Auto low brightness:** Set the Gear to automatically adjust the brightness depending on the ambient light conditions.
- **Screen timeout:** Set the length of time the Gear waits before turning off the display's backlight.

## Call

Change the call feature settings.

On the Settings screen, tap **Call**.

- **Auto call forwarding:** Set to forward the mobile device's incoming calls to the Gear.



The activation method for this feature may differ depending on your service provider.

- **Outgoing number:** View the outgoing call resource.
- **Voice answer:** Set the Gear to answer or reject calls using voice commands.
- **Show my caller ID:** Set whether to display your caller ID to other parties for outgoing calls.

- **Voicemail:** Access the voice mail service.
- **Block list:** Reject calls from specified phone numbers.



The **Outgoing number** option is available when the Gear is connected to a mobile device.

## Messages

Change the message feature settings.

On the Settings screen, tap **Messages**.

- **Send as audio:** Set the Gear to send a voice message as an audio file.
- **Block list:** View blocked numbers or messages.

## Connections

### Bluetooth

Connect to a mobile device via Bluetooth. You can also connect a Bluetooth headset to your Gear.



- Samsung is not responsible for the loss, interception, or misuse of data sent or received via Bluetooth.
- Always ensure that you share and receive data with devices that are trusted and properly secured. If there are obstacles between the devices, the operating distance may be reduced.
- Some devices, especially those that are not tested or approved by the Bluetooth SIG, may be incompatible with your device.
- Do not use the Bluetooth feature for illegal purposes (for example, pirating copies of files or illegally tapping communications for commercial purposes).  
Samsung is not responsible for the repercussion of illegal use of the Bluetooth feature.

On the Settings screen, tap **Connections** → **Bluetooth**.

- **Bluetooth:** Turn the Bluetooth feature on or off.
- **BT headset:** Search for Bluetooth headsets and connect them to the Gear.

## Mobile networks

Customise settings to control networks.

On the Settings screen, tap **Connections** → **Mobile networks**.

- **Mobile networks:**

- **Auto on/off:** Set the Gear to automatically connect to or disconnect from the mobile network depending on the Gear's connection to the mobile device via Bluetooth.



- When the Gear is connected to the mobile device via Bluetooth, the Gear's mobile network is turned off to save battery power. Then, the Gear will not receive messages and calls made to the Gear's phone number.
- The Gear's mobile network is automatically turned on after a moment when no Bluetooth connection is detected. Then, you can receive messages and calls made to the Gear's phone number.

- **Always on:** Set the Gear to connect to the mobile network.

When this option enabled, you can receive incoming calls and messages to the Gear and mobile devices' phone numbers.



When you enable the **Always on** option, the Gear's battery consumption may increase.

- **Always off:** Set the Gear not to connect to the mobile network.

When this option is enabled, you cannot receive incoming calls and messages to the Gear's phone number. If the Gear is connected to the mobile device via Bluetooth, you can receive incoming calls or notifications from the mobile device.

- **Mobile data:** Set the Gear to use data connections on any mobile network.
- **Data roaming:** Set the Gear to use data connections when you are roaming.
- **Network mode:** Select a network type.
- **Network operators:** Search for available networks and manually register a network.
- **Access Point Names:** Set up access point names (APNs).

## Wi-Fi

Activate the Wi-Fi feature to connect to a Wi-Fi network.

This feature is available when the Gear is not connected to the mobile device via Bluetooth.

1 On the Settings screen, tap **Connections** → **Wi-Fi**, and then tap **Wi-Fi** switch to activate it.

2 Select a network from the Wi-Fi networks list.  
Networks that require a password appear with a lock icon.

3 Tap **CONNECT**.



- Once the Gear connects to a Wi-Fi network, the Gear will reconnect to that network each time it is available without requiring a password. To prevent the Gear connecting to the network automatically, select it from the list of networks and tap **FORGET**.
- If you cannot connect to a Wi-Fi network properly, restart your device's Wi-Fi feature or the wireless router.
- Turn off Wi-Fi to save the battery when not in use.

## NFC

The Gear allows you to make payments and buy tickets for transportation or events after downloading the required apps.

On the Settings screen, tap **Connections** → **NFC**.



The Gear contains a built-in NFC antenna. Handle the Gear carefully to avoid damaging the NFC antenna.

- **NFC:** Activate the NFC feature to link your Gear to your credit or debit card.
- **Tap and pay:** Set the default payment app for mobile payments.



This feature may not be available depending on the region or service provider.

## Making payments with the NFC feature

Before you can use the NFC feature to make payments, you must register for the mobile payment service. To register or get more information about the service, contact your service provider.

- 1 On the Settings screen, tap **Connections** → **NFC** and then tap the **NFC** switch to activate it.
- 2 Touch the NFC antenna area at the top of the Gear's touchscreen to the NFC card reader.

To set the default payment app, open the settings screen and tap **Connections** → **NFC** → **Tap and pay**, and then select an app.



The payment services list may not include all available payment apps.

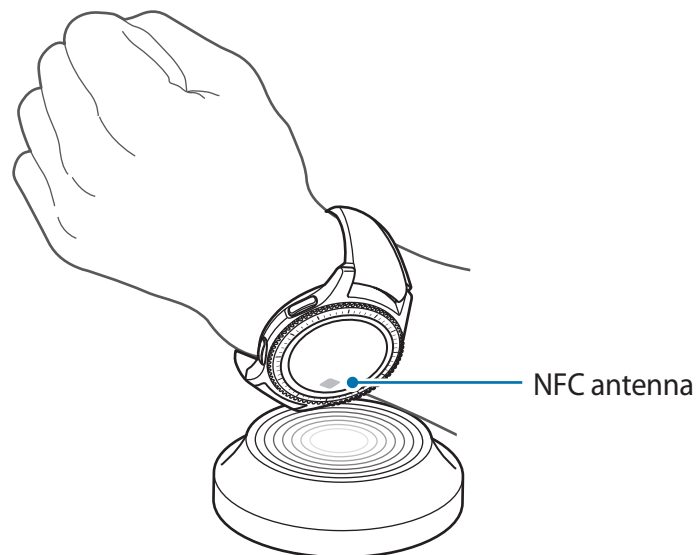

## Alerts

Set the Gear to vibrate when it is disconnected from your mobile device.

On the Settings screen, tap **Connections** → **Alerts**.

## Flight mode

This disables all wireless functions on your device. You can use only non-network services.

On the Settings screen, tap **Connections** → **Flight mode**.



Make sure the device is turned off during takeoff and landing. After takeoff, you can use the device in flight mode if allowed by aircraft personnel.

## Data usage

Keep track of your data usage amount and customise the settings for the limitation.

On the Settings screen, tap **Connections** → **Data usage**.

- **Mobile data:** Set the Gear to use data connections on any mobile network.
- **Data usage limit:** Set a limit for mobile data usage.
- **Data usage cycle:** Set a data reset cycle to monitor data usage between usage periods.
- **Start date:** Set the start date of the data usage cycle.
- **Usage details:** View your total data usage for the current cycle.

## Location

Set the Gear to allow apps to use your current location information.

On the Settings screen, tap **Connections** → **Location**.

Tap the **Location** switch to activate it and then select a method to collect your location data.

## Security

Change the settings for securing the Gear.

On the Settings screen, tap **Security**.

- **Screen lock:** Activate or deactivate the screen lock feature. When the screen lock feature is activated, the Gear prevents others from accessing the personal information saved in your Gear.

## Accessibility

Configure various settings to improve accessibility to the Gear.

On the Settings screen, tap **Accessibility**.

- **Vision:** Customise the settings to improve accessibility for visually impaired users.
- **Hearing:** Customise the settings to improve accessibility for users with hearing impairment.
- **Direct access:** Set the Gear to activate the screen reader feature when you tap the screen three times with two fingers.

## Input

Change the text input settings.

On the Settings screen, tap **Input**.

- **Default keyboard:** Select a default keyboard type for text input.
- **Keyboard settings:** Change the Samsung keyboard settings.

## Power saving

Activate power saving mode to save battery power by limiting the Gear's functions.

On the Settings screen, tap **Power saving**.

## Gear info

View the Gear's information.

On the Settings screen, tap **Gear info**.

- **Update Gear software:** Update your Gear to the latest software.
- **Auto update apps:** Change the auto update settings for apps on your Gear.
- **About device:** Access information about the Gear.
- **Report diagnostic and usage info:** Set the Gear to automatically send the device's diagnostic and usage information to Samsung.
- **Reset Gear:** Reset settings to the factory default values and delete all data.
- **Debugging:** Activate or deactivate debugging mode when developing apps for the Gear.



The **Update Gear software** and **Auto update apps** options are available when your Gear is not connected to your mobile device.

## Connect to new phone

Connect your Gear to a new mobile device. The Gear can connect to another mobile device after performing a light reset to delete data except media files and personal data.

On the Settings screen, tap **Connect to new phone**.



This feature is available when the Gear is connected to a mobile device.

## Connect to phone

Connect to a mobile device while you are using the Gear by itself. You can select whether to restore the Gear's data that is saved on the mobile device.

On the Settings screen, tap **Connect to phone** → **OK**.

- ✓ : Connect your Gear to a mobile device and sync your health information, setting values, and contacts information saved in the Gear.
- ✗ : Connect your Gear to a mobile device after resetting all the data saved in the Gear.



This feature is available when your Gear is not connected to your mobile device.



## Updating the Gear

The Gear can be updated to the latest software.

### Updating via the Gear

The Gear can be updated without connecting it to your mobile device.

On your Gear, open the Apps screen, tap  (**Settings**) → **Gear info** → **Update Gear software**.



This feature is available when your Gear is not connected to your mobile device.

### Updating software via the Samsung Gear app

The Gear can be directly updated to the latest software by the firmware over-the-air (FOTA) service.

- 1 Launch **Samsung Gear** on your mobile device.
- 2 Tap **SETTINGS** → **About Gear** → **Update Gear software** → **Download updates manually**.
- 3 Read the on-screen information and tap **DOWNLOAD**.

The Gear will copy the updated software from your mobile device and restart.



To automatically check for available updates, tap the **Download updates automatically** switch to activate it. Updates will be downloaded only when the device is connected to a Wi-Fi network.

# Samsung Gear app

## Introduction

To connect your Gear to a mobile device, you must install the Samsung Gear app on your mobile device. You can check the Gear's status and download recommended watch faces and apps. You can also customise your Gear's various settings, such as your notification settings.

Launch **Samsung Gear** on your mobile device.



Some features may not be available depending on the type of connected mobile device.



Tap  to use the following options:

- **Disconnect:** Disconnect your Gear from the currently connected mobile device.
- **Connect new Gear:** Disconnect your Gear from the currently connected mobile device and connect a new Gear. Tap **SCAN** to find a new Gear. To reconnect to a previously connected Gear, select one from the **Paired devices** list.
- **Auto switch device:** Set your mobile device to remember the previously connected Gear and automatically connect to it when you wear it.
- **Help:** Ask questions or view frequently asked questions.
- **User manual:** View the user manual to learn how to use your Gear.
- **Contact us: Samsung Members** offers support services to customers, such as device problem diagnosis, and lets users submit questions and error reports. You can also share information with others in the Galaxy users' community or view the latest Galaxy news and tips. **Samsung Members** can help you solve any problems you might encounter while using your device.



This feature may not be available depending on the region or service provider.

## INFO

View your Gear's status, S Health data, and download recommended watch faces and apps. Launch **Samsung Gear** on your mobile device and tap **INFO**.

### About Gear

Provide a status overview of your Gear's battery, storage, and RAM.

Select an item to view its details.

### Suggested watch faces

You can download recommended watch faces from **Galaxy Apps**.

Select a suggested watch face to download it. To view more watch faces, tap **VIEW MORE WATCH FACES**.

## Suggested apps

You can download recommended apps from **Galaxy Apps**.

Select a suggested app to download it. To view more apps, tap **VIEW MORE APPS**.

## Health

View S Health's saved data.

Tap **OPEN S HEALTH**.

# SETTINGS

## Watch faces

You can change the type of watch to be displayed on the Watch screen.

Launch **Samsung Gear** on your mobile device, tap **SETTINGS** → **Watch faces**, and select a desired watch type. The watch face you selected will be applied on the Watch screen.

Tap **STYLISE** to select background and items to display on the watch face.

## Notifications

Change settings for the notification feature. Stay up to date with a variety of events, such as new messages received on the mobile device.

Launch **Samsung Gear** on your mobile device, tap **SETTINGS** → **Notifications**, tap the switch to activate it, and then activate items.

- **Manage notifications:** Select apps on the mobile device to send notifications to the Gear.
- **Show only while wearing Gear:** Set the Gear to show notifications only while you are wearing it.
- **Show while using phone:** Set the Gear to show notifications while using your mobile device.

- **Turn on screen:** Set the Gear to turn on the screen when the notification is received.
- **Auto show details:** Set the Gear to show details for notifications when they are received.
- **Notification indicator:** Set the Gear to display a yellow dot on the Watch screen to alert you to notifications that you have not checked.
- **Smart relay:** Set the mobile device to display notification information that is displayed on the Gear when you pick up the mobile device.



- This feature is only available when the Gear's screen is turned on.
- Some mobile devices do not support this feature.
- The mobile device must be unlocked first to view details when the screen is locked.

## Apps

Customise the Gear's Apps screen. You can select and rearrange apps.

Launch **Samsung Gear** on your mobile device and tap **SETTINGS** → **Apps**.

### Uninstalling apps

Tap  → **Uninstall** and tap  next to the apps you want to remove from the Gear.

### Reordering apps

Tap  → **Reorder** and tap  next to an app and drag it up or down to another position.

## Send content to Gear

Transfer saved audio or image files from your mobile device to your Gear.

Launch **Samsung Gear** on your mobile device and tap **SETTINGS** → **Send content to Gear**.



When the Gear does not have enough available memory, it deletes files that you have not set as your favourites in order from oldest to newest.

- **Select tracks:** Select audio files and manually send them from the mobile device to the Gear.

- **Auto sync:** Set the device to sync audio files with the Gear while the Gear is charging.
- **Select photos:** Select images and manually send them from the mobile device to the Gear.
- **Auto sync:** Set the device to sync images with the Gear while the Gear is charging.
- **Albums to sync:** Select an image folder to sync with the Gear.

## Send SOS requests

Set the device to send help messages by pressing the Gear's Home key three times. You can also set it to automatically call your emergency contacts.

Launch **Samsung Gear** on your mobile device, tap **SETTINGS** → **Send SOS requests**, and tap the switch to activate it. Refer to [SOS messages](#) for more information.

## Find My Gear

Remotely control your Gear when it is lost or misplaced.

Launch **Samsung Gear** on your mobile device and tap **SETTINGS** → **Find My Gear**.

- **Reactivation lock:** Set the Gear to require your Samsung account information after the device has been reset. This prevents others from reactivating your device if it is lost or stolen.
- **Control remotely:**
  - **Locate Gear:** View the location of your Gear.
  - **Lock Gear:** Remotely lock the Gear to prevent unauthorised access. This feature can be activated when the Bluetooth connection between the Gear and mobile device ends while a remote connection is activated.
  - **Reset Gear:** Remotely delete all personal information stored in the Gear. After the Gear is reset, you cannot restore the information or use the Find My Gear feature.

## Gear connection

Customise your Gear's wireless connection settings.

Launch **Samsung Gear** on your mobile device, tap **SETTINGS** → **Gear connection**, and tap the switch to activate it.

- **Remote connection:** Set the Gear to remotely connect to the mobile device when a Bluetooth connection between the devices is not available.
- **Sync Wi-Fi profiles:** Set the device to sync the list of saved Wi-Fi networks with your Gear.

## Quick messages

Edit or add templates used for replying to messages.

- 1 Launch **Samsung Gear** on your mobile device and tap **SETTINGS** → **Quick messages**.
- 2 Tap **Quick responses** or **Call-decline messages**.
- 3 Select a template to edit.  
To create additional templates, tap .
- 4 Edit the template and tap **SAVE**.

## Register Gear eSIM profile

Install a profile and activate the eSIM by scanning the QR code on the eSIM voucher.

Launch **Samsung Gear** on your mobile device and tap **SETTINGS** → **Register Gear eSIM profile**.

## Auto call forwarding

Set to forward your mobile device's incoming calls to the Gear on your mobile device. To use this feature, your Gear and your mobile device should be remotely connected using your Samsung account.

- 1 Launch **Samsung Gear** on your mobile device and tap **SETTINGS** → **Auto call forwarding**.
- 2 Tap **Number setting** and enter your Gear's phone number.
- 3 Tap the switch to activate it.



- A mobile device subscription may be required and the activation method for this feature may differ depending on your service provider.
- The method of activating this feature may differ depending on your service provider

## Social network sharing

Share your exercise achievements in S Health with your friends on social media.

Launch **Samsung Gear** on your mobile device and tap **SETTINGS** → **Social network sharing**. Select a social network service and sign in to it.

When you select the share option in S Health on your Gear or your mobile device, your exercise information will be posted on your selected social network service.

## S Health

View the data saved in the S Health app.

Launch **Samsung Gear** on your mobile device and tap **SETTINGS** → **S Health**.



## Samsung Galaxy Apps

Purchase and download apps that are specialised for the Gear.

Launch **Samsung Gear** on your mobile device and tap **SETTINGS** → **Samsung Galaxy Apps**.

Browse by category and select an app to download.

## About Gear

View your Gear's status, back up or restore data, or update the Gear's software.

Launch **Samsung Gear** on your mobile device and tap **SETTINGS** → **About Gear**.

- **Battery:** Check the remaining battery power and time to use the Gear.



The usage time left shows the time remaining before the battery power runs out. Usage time left may vary depending on your device settings and operating conditions.

- **Storage:** Check the status of the used and available memory. To delete unnecessary files, tap **CLEAN NOW**.



The actual available capacity of the internal memory is less than the specified capacity because the operating system and default apps occupy part of the memory. The available capacity may change when you update the device.

- **RAM:** Check the status of the used and available RAM. To speed up your Gear by reducing the amount of RAM you are using, tick apps from the apps list, and tap **CLEAN NOW**.
- **Update Gear software:** Update the Gear to the latest software.
- **Back up and restore:** Back up the Gear's data on the Samsung Gear app or restore backup data.
- **Legal information:** View the legal information for the Gear.
- **Unknown sources:** Set the Gear to allow the installation of apps from unknown sources.
- **Samsung account:** View the Samsung account information.
- **Device name:** Change the Gear's name.

## Backing up and restoring data

Keep the Gear's settings data and other app settings and restore them later.

To back up data, launch **Samsung Gear** on your mobile device and tap **SETTINGS** → **About Gear** → **Back up and restore** → **Back up data**. The data will be saved in Samsung Cloud.



- Music and images saved on the Gear will not be backed up.
- S Health app data will be automatically saved on the connected mobile device's S Health app.

To restore, launch Samsung Gear on your mobile device and tap **SETTINGS** → **About Gear** → **Back up and restore** → **Restore data**. The latest backup data will be restored.

## About Samsung Gear app

View version information of the Samsung Gear app.

Launch **Samsung Gear** on your mobile device and tap **SETTINGS** → **About Samsung Gear app**.

# Appendix

## Troubleshooting

Before contacting a Samsung Service Centre, please attempt the following solutions. Some situations may not apply to your Gear.

### Your Gear does not turn on

When the battery is completely discharged, your Gear will not turn on. Charge the battery completely before turning on the Gear.

### Your Gear displays network or service error messages

- When you are in areas with weak signals or poor reception, you may lose reception. Move to another area and try again. While moving, error messages may appear repeatedly.
- You cannot access some options without a subscription. For more information, contact your service provider.

### The touchscreen responds slowly or improperly

- If you attach a screen protector or optional accessories to the touchscreen, the touchscreen may not function properly.
- If you are wearing gloves, if your hands are not clean while touching the touchscreen, or if you tap the screen with sharp objects or your fingertips, the touchscreen may malfunction.
- The touchscreen may malfunction in humid conditions or when exposed to water.
- Restart your Gear to clear any temporary software bugs.
- Ensure that your Gear software is updated to the latest version.
- If the touchscreen is scratched or damaged, visit a Samsung Service Centre.

## Your Gear freezes or has fatal errors

Try the following solutions. If the problem is still not resolved, contact a Samsung Service Centre.

### Restarting the device

If your Gear freezes or hangs, you may need to close apps or turn off the device and turn it on again.

### Forcing restart

If your Gear is frozen and unresponsive, press and hold the Home key (Power key) for more than 7 seconds to restart it.

### Resetting the device

If the methods above do not solve your problem, perform a factory data reset.

On the Apps screen, tap  (**Settings**) → **Gear info** → **Reset Gear**. Before performing the factory data reset, remember to make backup copies of all important data stored in the Gear.

## Another Bluetooth device cannot locate your Gear

- Ensure that the Bluetooth wireless feature is activated on your Gear.
- Reset your Gear and try again.
- Ensure that your Gear and the other Bluetooth device are within the Bluetooth connection range (10 m). The distance may vary depending on the environment the devices are used in.

If the tips above do not solve the problem, contact a Samsung Service Centre.

## **A Bluetooth connection is not established or your Gear and the mobile device are disconnected**

- Ensure that the Bluetooth feature on both devices is activated.
- Ensure there are no obstacles, such as walls or electrical equipment, between the devices.
- Ensure that the latest version of the Samsung Gear app is installed on the mobile device.
- Ensure that your Gear and the other Bluetooth device are within the Bluetooth connection range (10 m). The distance may vary depending on the environment the devices are used in.
- Restart both devices and launch the Samsung Gear app on the mobile device again.

## **Calls are not connected**

- Ensure that your Gear is connected to a mobile device.
- Ensure that your mobile device has accessed the right cellular network.
- Ensure that you have not set call barring for the phone number you are dialling on the mobile device.
- Ensure that you have not set call barring for the incoming phone number on the mobile device.

## **Others cannot hear you speaking on a call**

- Ensure that you are not covering the built-in microphone.
- Ensure that the microphone is close to your mouth.

## **Sound echoes during a call**

Adjust the volume or move to another area.

## **A cellular network or the Internet is often disconnected or audio quality is poor**

- Ensure that you are not blocking the Gear's antenna area.
- When you are in areas with weak signals or poor reception, you may lose reception. You may have connectivity problems due to issues with the service provider's base station. Move to another area and try again.
- When using the Gear while moving, wireless network services may be disabled due to issues with the service provider's network.

## **The battery icon is empty**

Your battery is low. Charge the battery.

## **The battery does not charge properly (For Samsung-approved chargers)**

- Ensure that you connect the Gear to the wireless charging dock and connect the dock to the charger properly.
- Visit a Samsung Service Centre and have the battery replaced.

## **The battery depletes faster than when first purchased**

- When you expose the Gear or the battery to very cold or very hot temperatures, the useful charge may be reduced.
- Battery consumption increases when you use some apps.
- The battery is consumable and the useful charge will get shorter over time.

## **Your Gear is hot to the touch**

When you use apps that require more power or use apps on your Gear for an extended period of time, your Gear may feel hot to the touch. This is normal and should not affect your Gear's lifespan or performance.

If the device overheats or feels hot for a prolonged period, do not use it for a while. If the device continues to overheat, contact a Samsung Service Centre.

## Your Gear cannot find your current location

The Gear uses your mobile device's location information. GPS signals may be obstructed in some locations, such as indoors. Set the mobile device to use Wi-Fi or mobile network to find your current location.

## Data stored in the Gear has been lost

Always make backup copies of all important data stored in the Gear through the Samsung Gear app. Otherwise, you cannot restore data if it is corrupted or lost. Samsung is not responsible for the loss of data stored in the Gear.

## A small gap appears around the outside of the Gear case

- This gap is a necessary manufacturing feature and some minor rocking or vibration of parts may occur.
- Over time, friction between parts may cause this gap to expand slightly.

## Removing the battery

- **To remove the battery, contact an authorised service centre. To obtain battery removal instructions, please visit [www.samsung.com/global/ecodesign\\_energy](http://www.samsung.com/global/ecodesign_energy).**
- For your safety, you **must not attempt to remove** the battery. If the battery is not properly removed, it may lead to damage to the battery and device, cause personal injury, and/or result in the device being unsafe.
- Samsung does not accept liability for any damage or loss (whether in contract or tort, including negligence) which may arise from failure to precisely follow these warnings and instructions, other than death or personal injury caused by Samsung's negligence.

## Copyright

Copyright © 2016 Samsung Electronics

This manual is protected under international copyright laws.

No part of this manual may be reproduced, distributed, translated, or transmitted in any form or by any means, electronic or mechanical, including photocopying, recording, or storing in any information storage and retrieval system, without the prior written permission of Samsung Electronics.

## Trademarks

- SAMSUNG and the SAMSUNG logo are registered trademarks of Samsung Electronics.
- Bluetooth® is a registered trademark of Bluetooth SIG, Inc. worldwide.
- Wi-Fi®, Wi-Fi Protected Setup™, Wi-Fi Direct™, Wi-Fi CERTIFIED™, and the Wi-Fi logo are registered trademarks of the Wi-Fi Alliance.
- All other trademarks and copyrights are the property of their respective owners.