

vaxTM
CORDLESS
SlimVac

**CORDLESS SLIM VAC WITH
DETACHABLE HANDHELD**

LET'S GET STARTED.

TBTTV1D1



Let's talk safety



Basic safety precautions

This vacuum cleaner is intended for household use only and NOT for commercial or industrial use.

- This vacuum cleaner does not stay upright without constant support, in between uses lie flat on the floor in a suitable location so it does not become a trip hazard or can be stepped on.
- Only use the vacuum cleaner indoors on dry surfaces and keep the area you're cleaning well lit.
- Keep fingers, hair and loose clothing away from moving parts and openings whilst using the vacuum cleaner.



Don'ts

- Don't charge the vacuum cleaner outdoors, or leave the charger connected to the mains when not in use.
- Don't use this vacuum cleaner if it has been dropped, damaged, immersed in water or left outdoors.
- Don't handle the charger plug or use the vacuum cleaner with wet hands.
- Don't run over the charger cord or use the vacuum cleaner if the charger cord or plug is damaged.
- Don't vacuum up hard or sharp objects such as glass, nails, screws, coins, etc.



Do's

- Always turn off, unplug the vacuum cleaner from the charger and remove the battery before carrying out any maintenance. Please refer to the appropriate section in the user guide to review necessary precautions.
- Always make sure the filter and dirt container are fitted correctly before using your vacuum cleaner.
- Always switch off the vacuum cleaner before disconnecting or connecting the reach wand and accessories.
- Keep all openings clear and free from debris as this may affect the airflow/suction.
- Always protect the charger cord from heated surfaces or when near open flames.
- If charging the vacuum cleaner through an extension cord, use only CE approved 13amp extension cords, non-approved extension cords

- This vacuum cleaner can be used by children aged from 8 years and above and persons with reduced physical, sensory or mental capabilities or lack of experience and knowledge if they have been given supervision or instruction concerning use of the vacuum cleaner in a safe way and understand the hazards involved. Children should not play with the vacuum cleaner. Cleaning and user maintenance should not be made by children without supervision.
- Only Vax recommended tools and accessories should be used with this vacuum cleaner.
- The battery must be removed from the appliance before it is scrapped.

- Don't attempt to remove blockages with sharp objects as this may cause damage to your vacuum cleaner.
- Don't vacuum up hot coals, cigarette butts, matches or smoking hot burning items or use in an area where there may be harmful fluids (chlorine, bleach, and ammonia drain cleaner).
- Don't use the vacuum cleaner with incorrect voltage as this may result in damage or injury to the user. The correct voltage is listed on the ratings label.
- Don't leave the vacuum cleaner in one spot for an extended period of time when the brushbar is activated. This vacuum cleaner is fitted with a rotating brushbar which if left in one place may cause damage to the floor surface.

may overheat. Care should be taken to arrange the extension cord as it can be a trip hazard.

- Take extra care when using the vacuum cleaner on the stairs.
- Store your vacuum cleaner in a cool, dry area. If filters have been cleaned as per user guide instructions ensure they are thoroughly dry before storing away.
- For the purposes of recharging the battery, only use the detachable supply unit with provided charger only (charger model number - YLJXA-U220030) with this vacuum cleaner.
- Always check accessories are free from dirt and debris before usage
- The appliance must be disconnected from the supply mains when removing the battery.
- The battery is to be disposed of safely (for further information, read the Getting Started section).

Please keep instructions for further use.

Thank you for buying this Cordless Slim Vac.

Taking care of your carpets and hard floors

The Cordless Slim Vac series is designed to make vacuuming carpets and hard floors regularly, as effective and efficient as possible and this user guide will help you get the most out of your machine.

Maintaining your carpets and hard floors will ensure they keep their appearance for longer and Vax will help you take good care of them.

Taking care of your Cordless Slim Vac

Also inside this guide are instructions on maintaining your new machine, so that it's ready when you are to tackle your carpets and hard floors.

We're here if you need us

Instead of taking me back to the shop,
simply visit our online support:

vax.co.uk/support

Still need to get in touch?

Our UK based Customer Care Team are here to support you.
For help with assembly, operational or performance problems, or buying and fitting new accessories,
you can find all our contact details at **vax.co.uk/contact**

This user guide can be found online at: vax.co.uk/support

The Vax logo is displayed in a bold, orange, sans-serif font. The letters 'vax' are lowercase, and a trademark symbol (TM) is positioned to the upper right of the 'x'.

Let's talk safety

Getting to know your machine

Getting started

Using your machine

Taking care of your machine

Let's talk technical

Accessories

What to do if it goes wrong

Getting in touch

Cordless Slim Vac

Included with your machine



3-in-1 Tool

Model comes with a charger, battery, wall mount, 2 wall plugs, 2 screws and user guide.

Contents vary dependant on model purchased.

Getting to know your machine

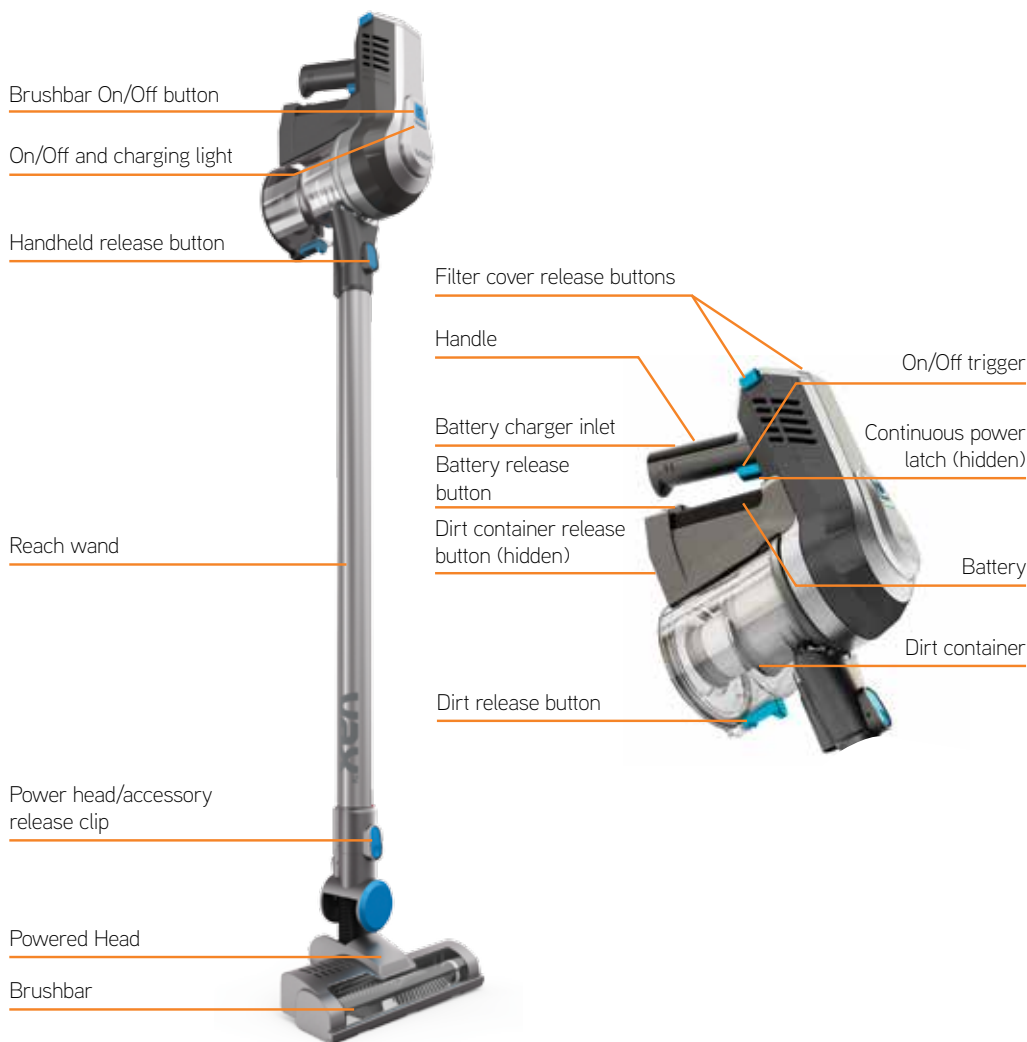

Technical Specification

Name **Cordless Slim Vac**
Battery voltage **See product rating label**
Run time **20 minutes***
Charge time **8 hours**
Weight **2 kg**
Dust bin capacity **0.6L**

Accessories & Consumables

Post-motor filter
1-7-137849
3-in-1 tool
1-9-137854

To purchase consumables and accessories, please visit vax.co.uk

Subject to technical change without notice. *Turn off brushbar on hard floors. Images are illustrative only.

PLEASE READ 'LET'S TALK SAFETY' AT THE BEGINNING BEFORE USE

Before you begin

CAUTION: Always switch off the vacuum cleaner before connecting or disconnecting the handheld/attachments or removing and emptying the dirt container.

IMPORTANT: The vacuum cleaner is equipped with overheat protection. If for any reason the vacuum cleaner does overheat the thermostat will automatically turn the vacuum cleaner off. If this happens, remove the battery. Remove and empty the dirt container also check the vacuum cleaner for blockages. Allow the vacuum cleaner to cool for approximately 1 hour (if you have cleaned the filter please wait 24 hours for the filter to fully dry before putting back into the machine).

For best cleaning results, filters require cleaning at least every 3 months and should be replaced every 12 months depending upon use. If the vacuum cleaner is blocked, remove the battery before removing the blockage.

Assembling your Cordless Slim Vac

CAUTION: This vacuum cleaner is not free standing. In between uses or when carrying out any maintenance always lie flat on the floor in a suitable location so it does not become a trip hazard or can be stepped on.



Line up the connector on the reach wand with the Powered Head. Push the reach wand down onto the Powered Head until it clicks into place.



Push the handheld down onto the reach wand until it clicks into place.



The upright slim vacuum cleaner is not free standing and in between uses must always be placed in the wall bracket or laid flat on the floor, in a suitable location so it does not become a trip hazard or can be stepped on.

Getting started

Fixing the wall bracket



Fully assemble the vacuum but do not attach the battery.



Attach the wall bracket to the handle.



With the wall bracket attached, stand the vacuum close to the wall, in the upright position with the Powered Head flat on the floor.



Holding the wall bracket firmly in place, carefully remove the vacuum. Using a pencil make a small mark for each screw.



Use both screws and wall plugs to secure the wall bracket to the wall. Place covers over the screws.



Firmly press the vacuum handle into the wall bracket to secure.

PLEASE READ 'LET'S TALK SAFETY' BEFORE USE

CAUTION: The battery used in this device may present a risk of fire or chemical burn if mistreated. Do not disassemble or heat above manufacturer's maximum temperature limit (60° C/140°F) or incinerate. Replace battery with Vax battery only. Use of another battery may present a risk of fire or explosion. Dispose of used battery promptly. Keep away from children. Do not disassemble and do not dispose of in a fire. Do not attempt to disassemble the battery or remove any component projecting from the battery terminals. The battery and charger have no user serviceable parts. Fire or injury may result. Prior to disposal, protect exposed terminals with heavy insulating tape to prevent shorting. Remove the battery from the appliance before it is disposed of safely at your local battery recycling centre.

For best performance, the terminals on both the battery and the appliance must be clean and free from dust and dirt. Do not attempt to recharge non-rechargeable batteries. The battery must be removed from the appliance before it is scrapped. The appliance must be disconnected from the charger before use and when removing or installing the battery into the machine. In case of battery leakages avoid any contact with the skin. Contact our Customer Care Line on 0800 092 7737.

Installing and charging the battery

CAUTION: The appliance must be disconnected from the mains supply when removing the battery.

NOTE: The initial charge is 8 hours, charging will be required before first use. The vacuum can be charged with the handheld either attached to, or detached from, the reach wand. Failure to fully charge the battery before first use (initial charge 8 hours) may result in poor battery performance.



Slide the battery into the back of the handheld. The battery will click into position when correctly fitted.

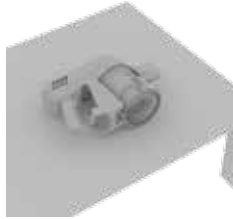

To charge the machine, detach the reach wand and lie the handheld on its side on a flat stable surface. You can also charge the machine whilst attached to the wall mount. Make sure the floorhead and wand are attached together.



Insert the charger lead into the charger inlet located on the back of the handle.



Plug the charger plug into the mains.

CAUTION: Do not use the vacuum cleaner when the machine is plugged in and charging.

CAUTION: For best performance the terminals on the battery and vacuum cleaner must be clean and free from dust and dirt. The life expectancy of the battery will vary depending on the usage of the vacuum cleaner.



The On/Off and charging light will flash red whilst the charger is connected.

Red light – The battery is charging.

Green light – The battery is charged (after 8 hours).

When charging for the first time a full 8 hour charge is required.

Using your machine

CAUTION: This vacuum cleaner has a constantly rotating brushbar when the brushbar 'ON' is selected. Never leave the vacuum cleaner in one spot for an extended period of time as this may damage the floor surface. The brushbar should be ON for carpets and OFF for hard floors.

CAUTION: If the brush bar has been obstructed, the motor protection sensor may have been activated, the light will flash Red and the brushbar will seize. Remove the Powered Head from the machine and clear any obstruction. Refit the Powered Head, switch on the vacuum cleaner by pressing the trigger and press the brushbar On/Off button.

Using as a slim vacuum cleaner



Squeeze the trigger located underneath the handle, the machine will switch 'On'. The On/Off and charging light will illuminate green indicating the power is on and the machine is charged. Release the trigger to switch the machine 'Off'.

Squeeze the trigger and push the 'Continuous power latch' towards the trigger. This will lock it into the 'On' position and will continue to power the machine without having to hold in the trigger. Push the latch away from the trigger to unlock and release the trigger.

Press the brushbar's On/Off button to activate. Repeat this process to de-activate the brushbar. The brushbar should be switched ON for carpets and OFF for hard floors.



When the vacuum cleaner is in use the On/Off and charging light will illuminate and flash red when the battery is running low. When the red light flashes the machine will turn off in 20 seconds. The user should recharge the machine.

Using as a handheld vacuum cleaner

Always take extra care when using the vacuum cleaner on the stairs.



Press the handheld release clip. Pull to separate the handheld from the reach wand.



The reach wand when attached to the Powered Head/accessory is not free standing, place safely and securely to one side.

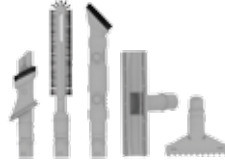

Choose an accessory (pictures illustrated dependent upon model).



Push the chosen accessory into the handheld until it clicks into place.



Squeeze the trigger located underneath the handle, the machine will switch 'On'. The On/Off and charging light will illuminate green indicating the power is on and the machine is charged. Release the trigger to switch the machine 'Off'.



Squeeze the trigger and push the 'Continuous power latch' towards the trigger. This will lock it into the 'On' position and will continue to power the machine without having to hold in the trigger. Push the latch away from the trigger to unlock and release the trigger.



All of the accessories including the Powered Head can be attached directly onto the handheld.

Using your machine

Using as a reach slim vacuum cleaner

The reach wand can be used for hard to reach places.



Press the Power Head/ accessory release clip and pull to remove the Powered Head from the reach wand.

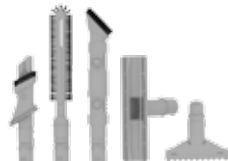

Choose an accessory (pictures illustrated dependent upon model).



Push the chosen accessory into the reach wand until it clicks into place.



Squeeze the trigger located underneath the handle, the machine will switch 'On'. The On/Off and charging light will illuminate green indicating the power is on and the machine is charged. Release the trigger to switch the machine 'Off'.



Squeeze the trigger and push the 'Continuous power latch' towards the trigger. This will lock it into the 'On' position and will continue to power the machine without having to hold in the trigger. Push the latch away from the trigger to unlock and release the trigger.



The reach wand can be used for hard to reach places and at different heights for above floor cleaning.



The upright slim vacuum cleaner is not free standing and in between uses must always be placed in the wall bracket or laid flat on the floor, in a suitable location so it does not become a trip hazard or can be stepped on.

Taking care of your machine

Removing the battery

CAUTION: Always remove the battery from the vacuum cleaner before performing maintenance or troubleshooting checks.

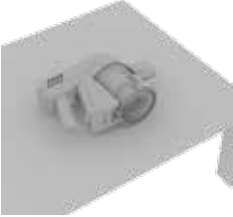

Lie the handheld on its side on a flat stable surface. Press the battery release button.

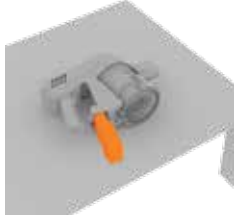

Slide the battery out from the back of the handheld.

Emptying the dirt container

WARNING: Don't over fill the dirt container to avoid blocking the air flow through the vacuum cleaner.



Press the handheld release clip. Pull to separate the handheld from the reach wand.



The reach wand when attached to the Powered Head/accessory is not free standing. Place safely and securely to one side.



Ensure the battery has been removed and hold the handheld over a bin, press the dirt release button to allow dirt/debris to fall out.

Taking care of your machine

Cleaning the post-motor filter

CAUTION: Always remove the battery from the vacuum cleaner before performing maintenance or troubleshooting checks. For continuous best performance the filter requires cleaning every 3 months and should be replaced every 12 months depending upon use. Do not use your vacuum cleaner without the filters in place.



Press the filter cover release buttons located on both sides of the filter cover and pull to remove the filter from the machine.



Pull to separate the filter from the filter cover/holder. Tap the filter and filter cover/holder over a bin to remove any dirt/debris. Wash the filter under running water (40 degrees max).

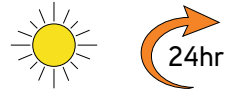

Leave for 24hrs or until fully dry before replacing.

Cleaning the filter and separator

CAUTION: Always empty the dirt container before cleaning the separator and filter and remove the battery, reach wand/accessories from the handheld.



Turn the handheld over and press the dirt container release button. Pull the dirt container forward and up away from the handheld to remove.



Twist the mesh filter anti-clockwise to unlock, lift to remove from the separator.



Twist the separator anti-clockwise to unlock, lift to remove from the handheld.

Taking care of your machine

Cleaning the filter and separator



Tap the mesh filter and separator over a bin to remove any dirt/debris. Using a dry cloth wipe away any remaining dirt/debris.

Refitting the separator, filter and dirt container

CAUTION: Incorrect fitting of the separator and filter will reduce suction.



Line up the arrows around the side of the separator with the arrows on the handheld. Twist the separator clockwise locking it into place.



Refit the mesh filter with the rim of the filter at the top. Twist the filter clockwise and lock into place.



Tilt the dirt container slightly forward and line up onto the handheld.



When the dirt container is seated on the handheld push the dirt container backwards to lock into place.

Let's talk technical

IMPORTANT: If the brush bar has been obstructed, the motor protection sensor may have been activated, the light will flash Red and the brushbar will seize. Remove the Powered Head from the machine and clear any obstruction. Refit the Powered Head, switch on the vacuum cleaner by pressing the trigger and press the brushbar On/Off button.

Removing and replacing the brushbar



Slide to release the brushbar. The cover can not be removed.



Lift to remove the left side of the brushbar first.



Clear any threads or hair from both ends of the brushbar and any dirt/debris inside the housing of the Powered Head.



When re-fitting the brushbar fit the right side into the housing first. Then line up and slot into place the left side.

Removing blockages from the Powered Head



The brushbar should be removed from the Powered Head before attempting to remove any blockages. Using scissors remove any threads or hair from around the brushbar and clear any dirt or debris from Powered Head.

Removing blockages from reach wand



To test for a blockage in the reach wand, drop a small ball of paper into the wand. The paper will drop through if the wand is clear. Use a broom handle or similar blunt object to remove any blockage.

Cleaning terminals



Using a dry cloth or soft dusting brush remove any dust/debris from terminals on battery and inside the handheld.

Also available Slim Vac Tools

Order at: www.vax.co.uk/spares-and-solutions

Refer to the 'Using your machine' section for tool assembly instructions.

Reach mode tools

High Angle Tool

1-9-138099

This handy tool allows you to tackle those high, hard to reach areas. It's perfect for reaching the top of curtains, cupboards and wardrobes.



Hard Floor Tool

1-9-138101

Use this tool to safely clean delicate hard floor surfaces without scuffing them. For best use please use at the end of the pole.

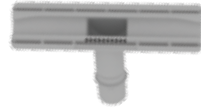

Handheld mode tools

3-in-1 Tool

1-9-137854

The multi functional 3 in 1 tool is ideal for use all around the home without having to switch between tools. It's perfect for those tricky corners and crevices, great for upholsteries such as; curtains and sofas, along with dusting furniture and hard surfaces.



Pet Tool/Stair Tool

1-9-138098

An ideal tool to help tackle those pet hairs! Simply clip this tool onto the handheld and begin cleaning. The rubber teeth are designed to agitate fine hair on both carpets and hard floors. This tool is also great for stair cleaning!



Multi-purpose Tool

1-9-138102

Its long, slim design allows you to reach into awkward crevices, such as inside and behind radiators. It's also ideal for cleaning blinds and in-between spindles on stairs! For best use please attach onto the handheld.



What to do if it goes wrong

Problem

Solution

Is there an accessory missing?

- Check the contents panel on the box to make sure the part is included with your vacuum cleaner.

Why does the vacuum cleaner have no power?

- Check the battery is inserted correctly into the vacuum cleaner.
- The battery may not be charged. Go to 'Getting Started'.
- The terminals on the battery and vacuum cleaner may be dirty. Go to 'Lets talk technical'.
- Battery might be too hot, remove and allow to cool for 1 hour.
- The vacuum cleaner has overheat protection which will cut the machine out. If this has happened, switch off the vacuum cleaner. Remove and empty the dirt container and check for blockages. Clean the filters and allow the vacuum cleaner to cool for approximately 1 hour (if you have washed the filters you will need to wait 24 hours for the filters to fully dry before putting them back into the vacuum cleaner).

Why isn't the light on the vacuum cleaner lit when the battery is charging?

- Check the battery charger is plugged in. Go to 'Getting started'.
- Check the battery is inserted correctly into the handheld. Go to 'Getting started'.
- The terminals on the battery and vacuum cleaner may be dirty. Go to 'Lets talk technical'.

Why won't the vacuum cleaner pick up?

- The dirt container may not be correctly fitted, remove the dirt container from the vacuum cleaner and check it's assembled correctly, refit ensuring it's locked into place.
- The separator is not correctly fitted. Go to 'Taking care of your machine'.
- The filters may be clogged, clean the filters. Go to 'Taking care of your machine'.
- The dirt container may be blocked, empty the dirt container. Go to 'Taking care of your machine'.
- The brush on the Powered Head has not been activated. Go to 'using your machine'.
- There maybe a blockage in the reach wand. Disconnect from the vacuum cleaner and carefully remove any blockages. Go to 'Let's talk technical'.

Why won't the brushbar turn?

- The brushbar has not been activated. Go to 'Using your machine'.
- If the Poweredhead/brush bar has been obstructed, the motor protection sensor may have been activated, the light will flash Red and the brushbar will seize. Remove the Powered Head from the machine and clear any obstruction. Refit the Powered Head, switch on the vacuum cleaner by pressing the trigger and press the brushbar On/Off button. Go to 'Let's talk technical'.

Why is dust escaping from the vacuum?

- The filters may be clogged, clean the filters. Go to 'Taking care of your machine'.
- The separator may be clogged, clean the separator. Go to 'Taking care of your machine'.
- Exhaust filter may be miss-assembled. Go to 'Taking care of your machine'.

It's quick and easy to
register for your **FREE**

**2 year
guarantee[†]**

Online at: **vax.co.uk/registration**

Please retain your original receipt for proof of purchase.



we're here if you need us
vax.co.uk/support

GET IN TOUCH

@ info@vax.co.uk ⓘ vax.co.uk

Vax Ltd, Pointon Way, Stonebridge Cross Business Park, Hampton Lovett, Droitwich, WR9 OLW, UK

EU Statement of Compliance: Manufacturer/EU importer: Vax Limited, hereby on our own responsibility, declare that the TBTTVID1 is manufactured in compliance with the following Directives: **Safety:** 2014/35/EU Low Voltage Directive.

EMC: 2014/30/EU Electromagnetic Compatibility Directive.

Waste electrical products and batteries should not be disposed of with household waste. Please recycle where facilities exist. Check with your Local Authority or retailer for recycling advice.

© 2017 Vax Limited. All rights reserved. The VAX trade mark and Vax lozenge are the property of Techtronic Floor Care Technology Ltd and are registered in the EU and may be pending or registered in other countries.

This marking on the product(s) and/or accompanying documents means that used electrical and electronic equipment (WEEE) should not be mixed with general household waste. For proper treatment, recovery and recycling, please take this product(s) to designated collection points where it will be accepted free of charge. Disposing of this product correctly will help save valuable resources and prevent any potential negative effects on human health and the environment, which could otherwise arise from inappropriate waste handling. Please contact your local authority for further details of your nearest designated collection point.

