

Cross 700C Hybrid Bike

Maintenance Manual

614/5251
619/2541
607/1026
612/5817

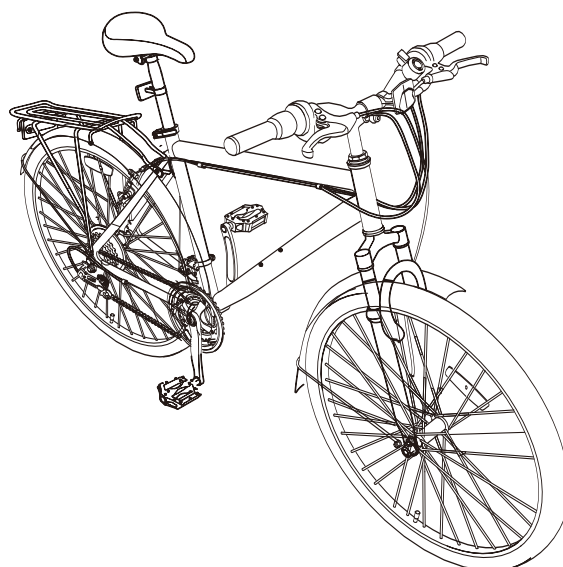

Important – Please read these instructions fully before performing any maintenance activities on the bike

These instructions contain important information that will help you get the best from your bike, ensuring safe and correct assembly, use and maintenance. The image in the manual is for instruction reference only.

Contents

Safety Information	3
Maintenance Instructions.....	4
Adjusting the Rear Derailleur.....	4
Adjusting V-Brakes	7
Inspecting and Maintaining the Wheels.....	10
Changing an Inner Tube.....	11
Routine Maintenance.....	13
Before and After Each Ride	13
Every Month.....	13
Every Six Months.....	14
Every Twelve Months	14
Lubrication information.....	15
Recommended tightening information.....	15

NEED ANY HELP?

**CUSTOMER
CARE HELPLINE
01702 208187**

support@bspokeleisure.co.uk

**WE CAN GIVE YOU GUIDANCE ON
ASSEMBLY,PARTS & TECHNICAL ADVICE**

Safety Information

Important – Please read these instructions fully before installation



WARNING! This Bike has been designed, assembled and tested in accordance with the EN ISO 4210 to ensure your safety. To make sure the bike remains safe, it should only be used for recreational use. Under no circumstances should it be used for competitive cycling, stunting, jumping or acrobatic manoeuvres. This may result in serious personal injury and damage to the bike.

WARNING! This bike is only suitable for use by riders (including any panniers and/or luggage) with a weight of less than 100 kg (220 lb).

WARNING! Under no circumstances should the bike be ridden with loose or torn clothing.

WARNING! Always take extra care when riding in wet, foggy, windy or icy conditions. The brakes may not be as effective and the braking distances may be increased.

WARNING! When riding in the dark, always make sure that the bike is fitted with suitable reflectors and front and rear lights.

WARNING! The front and rear tyres of the bike must be fully inflated before attempting to ride the bike. Under no circumstances should the tyres be inflated above the maximum pressure stated on the side of the tyres.

WARNING! If the wheel rim wear groove is no longer visible, the wheel rim should be replaced immediately. Do not attempt to ride the bike until the rim is replaced as the braking performance could be affected.

WARNING! Always wear a cycle helmet when riding the bike.

WARNING! Safety critical components should be replaced using genuine replacement parts. This bicycle is not suited for extreme use such as competitions, jumping, drop-offs or stunting. The rider must be aware that intensive use can result in damage to the frame, forks, wheels and other components of the bicycle that may affect its safety.

WARNING! As with all mechanical components, the bicycle is subjected to wear and high stresses. Different materials and components may react to wear or stress fatigue in different ways. If the design life of a component has been exceeded, it may suddenly fail possibly causing injuries to the rider. Any form of crack, scratches or change of colouring in highly stressed areas indicate that the life of the component has been reached and it should be replaced.

WARNING! The saddle height and handlebars are secure, set to a comfortable riding position and do not exceed the minimum insertion mark. The rider when seated should be able to reach the floor with their tip toes and be able to reach the brakes and handlebars without over balancing.

WARNING! Please be aware of the specific risk of entrapment during normal use and maintenance on the front/rear wheel, chain and sprocket.

WARNING! This bike is not suitable to add bike trailer.

WARNING! The rider shall follow the national legal requirement when use on public roads. (e.g. Lighting and reflectors)



CAUTION! The safety and smooth running of the bike can only be preserved with regular maintenance. Always ensure the bike is maintained in accordance with this maintenance manual.

CAUTION! Only use suitable tools to assemble the bike. The use of unsuitable tools may lead to personal injury and damage to the bike.

CAUTION! If the gears make a grinding sound while riding the bike, STOP immediately. The bike may be unsafe and prolonged use may lead to personal injury or damage to the bike. Inspect and, if required, repair the bike before reusing.

CAUTION! Do not clean your bike with pressure washers. These high pressure cleaning devices may remove lubricant and/or grease from bearings and internal bike parts. This may lead to poor performance.

CAUTION! When lubricating the moving parts of the bike, take care not to get any lubricant on the rims of the wheels or the brake pads.

CAUTION! Be careful not to trap the inner tube between the tyre levers and the wheel.

Maintenance Instructions



NOTE! You will need a second person to help you adjust the front and rear derailleur.

Adjusting the Rear Derailleur

While riding the bike, if the rear gears fail to work correctly and/or become noisy, the rear derailleur should be adjusted. The following are a few examples of when to do this:

- If a grinding noise comes from the rear gears while peddling
- If the chain fails to move between the rear gears or jumps gears
- If the chain routinely jumps off the highest (smaller) gear.

Adjusting the Rear Derailleur – Step 1

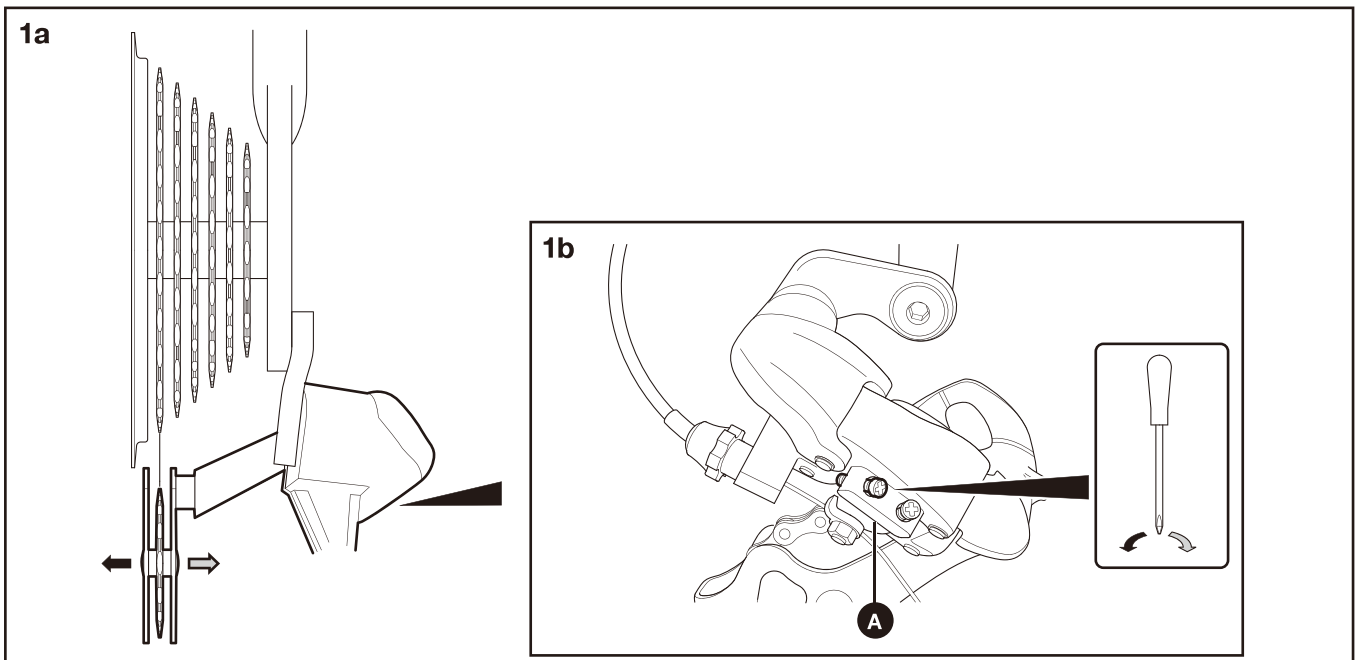

1a. Select the Lowest Gear



NOTE! The lowest gear is always the largest.

While raising the rear of the bike and rotating the pedals by hand, use the right hand twist shifter to select the lowest gear (number 1 on the indicator).

1b. Set the Position of the Lower Limit Screw

The lower limit screw **A** controls the position of the rear derailleur when the lowest gear is selected.

Using a suitable screwdriver, rotate the lower limit screw **A** until the small gears of the derailleur are vertically aligned below the lowest gear.

- Turn the lower limit screw **A** clockwise to move the derailleur to the right (when viewed from the back of the bike).
- Turn the lower limit screw **A** anti-clockwise to move the derailleur to the left (when viewed from the back of the bike).

Maintenance Instructions

Adjusting the Rear Derailleur – Step 2

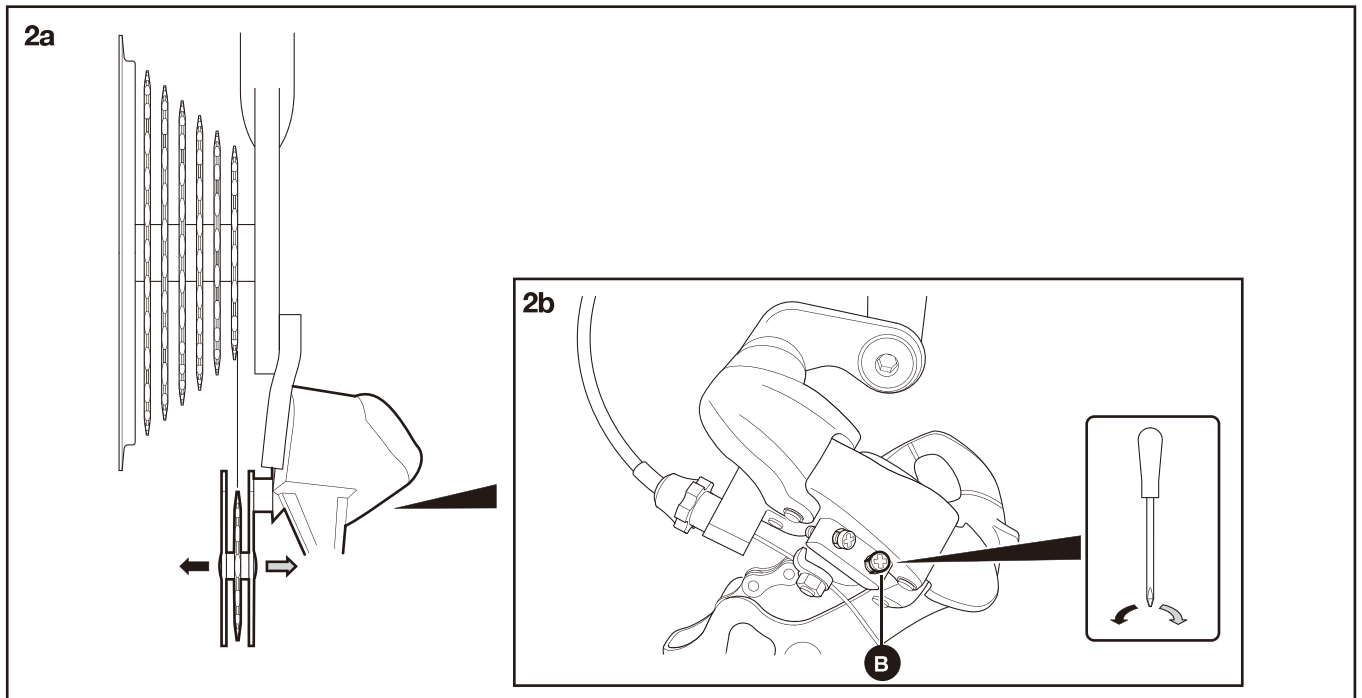

2a. Select the Highest Gear



NOTE! The highest gear is always the smallest.

While raising the rear of the bike and rotating the pedals by hand, use the right hand twist shifter to select the lowest gear (number 1 on the indicator).

2b. Set the position of the Upper Limit Screw

The upper limit screw **B** controls the position of the rear derailleur when the highest gear is selected.

Using a suitable screwdriver, rotate the upper limit screw **B** until the small gears of the derailleur are vertically aligned below the highest gear.

- Turn the lower limit screw **B** clockwise to move the derailleur to the left (when viewed from the back of the bike).
- Turn the lower limit screw **B** anti-clockwise to move the derailleur to the right (when viewed from the back of the bike).

Maintenance Instructions

Adjusting the Rear Derailleur – Step 3

3a & 3b

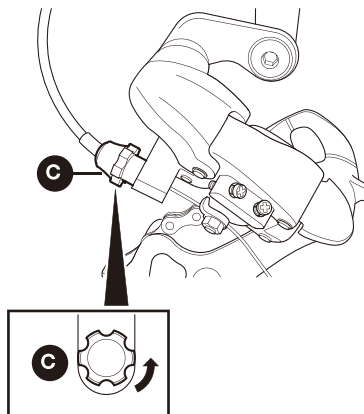

3a. Check the Gear Change

While raising the rear of the bike and rotating the pedals by hand, use the right hand twist shifter to change from the highest (smallest) gear to the lowest (largest) gear one at a time. If the rear derailleur is tuned correctly, the gears should change quickly without any grinding noises.

If the gears still do not operate correctly, carry out step 3b.

3b. Check the Cable Tension

If the gears change correctly between the highest and lowest gears but not between the lowest and highest gears, the cable tension should be increased.

Rotate the barrel adjuster **C** a quarter of a turn anti-clockwise.

Check the gear change by repeating step 3a.

Keep checking the gear change and slowly increasing the cable tension a quarter of a turn at a time until they operate correctly.

Maintenance | Instructions

Adjusting V-Brakes

Throughout the life of your bike, the front and rear v brakes may need adjusting if the brake cable has stretched or the brake arms have been knocked during use.

Adjusting the V-Brake Cable Tension

1a

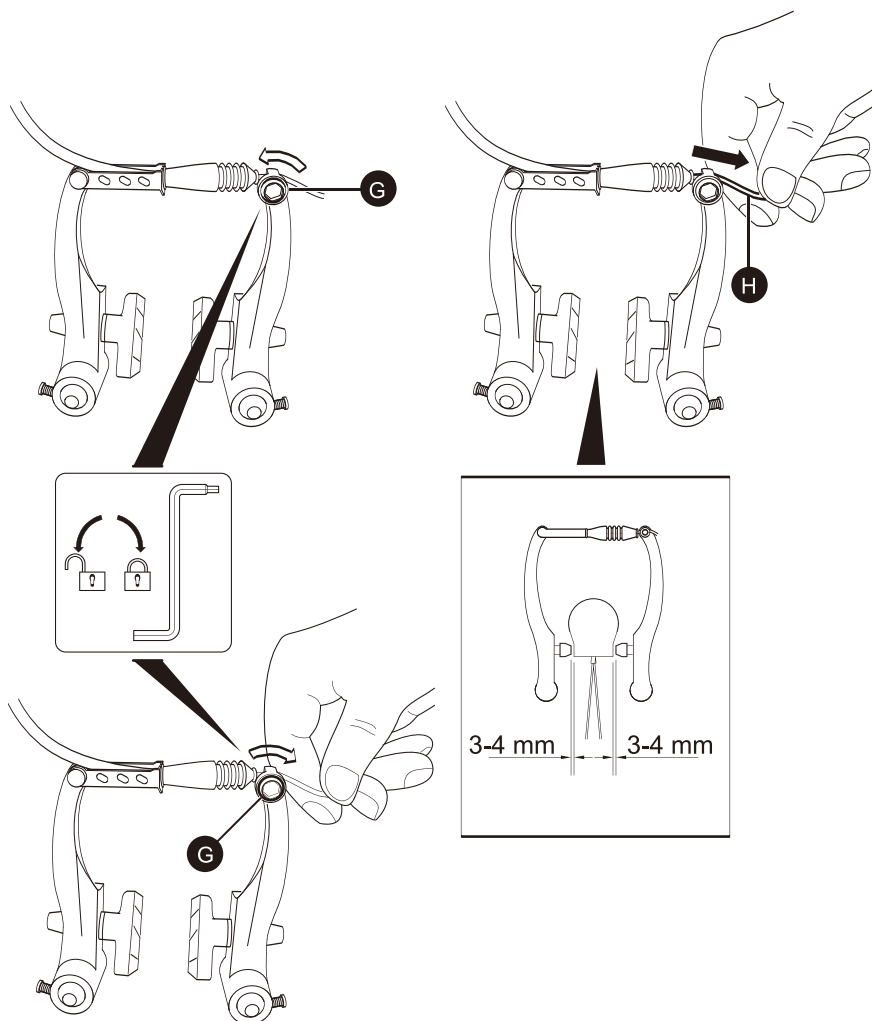

1a. Adjust the Brake Cable

The brake cable must be adjusted to ensure that the brakes are as close as possible to the wheel rim when no pressure is applied to the brake lever. But must not touch the rim and have some clearance.

Using a suitable spanner or socket, loosen the cable pinch bolt **G** until the brake cable **H** is free to move.

Pull the brake cable **H** until the brake pads are approximately 3 to 4 mm from the wheel rim.

Retighten the cable pinch bolt **G** while holding the brake cable in position.

Maintenance | Instructions

Adjusting the V-Brake Cable Tension (continued)

1b

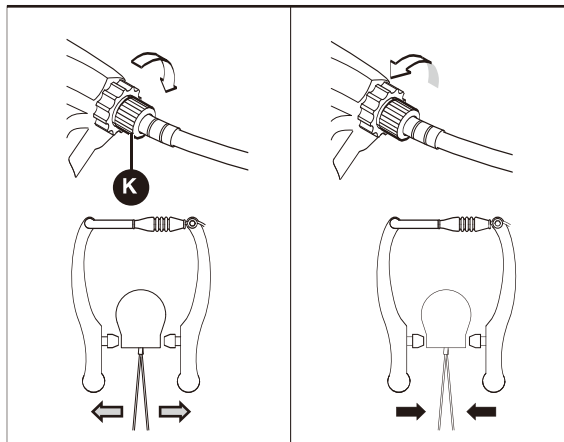
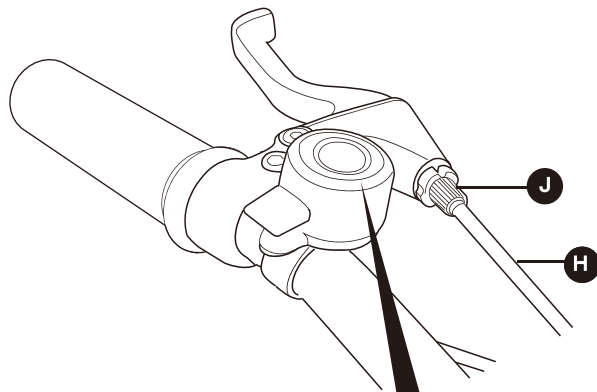

1b. Fine Tune the Cable Tension

If the brake pads are too close or too far away from the wheel rim once the brake cable has been adjusted in step 1a, fine tune the cable tension as described below.

Anti-clockwise is only if the brake shoes are too far away from the rim **J**.

Turn the barrel adjuster bolt to increase or decrease the cable tension. This will fine tune the position of the brakes.

- To increase the tension on the brake cable **H** and move the brakes towards the wheel rim, turn the barrel adjuster bolt **K** anti-clockwise.
- To decrease the tension on the brake cable **H** and move the brakes away from the wheel rim, turn the barrel adjuster bolt **K** clockwise.

Once the cable tension is correct, retighten the barrel adjuster locking nut **J**.

Maintenance | Instructions

Adjusting the V-Brake Spring Tension

1a & 1b

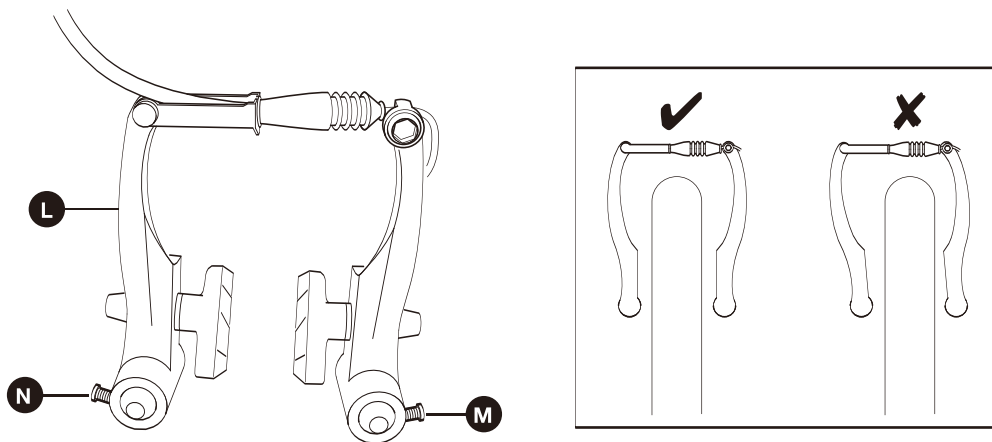

Over time, the brake arms can begin to lean to one side or another making the distance between the brake pads and the wheel rim uneven. This can be corrected by adjusting the spring tension of the individual brake arm.



NOTE!: When adjusting the spring tension, even adjustments should be made to both brake arms **L** until they are positioned evenly on either side of the wheel and rim.

1a. Adjusting the Spring Tension on the Right Hand Brake Arm.

If the brake arms **L** lean to the right (when viewed from the front of the bike), the right hand brake arm spring tension should be reduced. This can be achieved by turning the right spring tension screw **M** anti clockwise.

If the brake arms **L** lean to the left (when viewed from the front of the bike), the right hand brake arm spring tension should be increased. This can be achieved by turning the right spring tension screw **M** clockwise.

1b. Adjusting the Spring Tension on the Left Hand Brake Arm.

If the brake arms **L** lean to the right (when viewed from the front of the bike), the left hand brake arm spring tension should be increased. This can be achieved by turning the left spring tension screw **N** clockwise.

If the brake arms **L** lean to the left (when viewed from the front of the bike), the left hand brake arm spring tension should be decreased. This can be achieved by turning the left spring tension screw **N** anti clockwise.

Maintenance Instructions

Inspecting and Maintaining the Wheels

It is essential that you regularly inspect and maintain your wheels, especially if your bike becomes unstable or vibrates while riding.

1a. Inspect the Trueness of the Wheels

Over the life of the bike, the wheels may begin to run out of true. This is when the wheel buckles from side to side.

To check the trueness of a wheel, lift the bike up and spin the wheel. If the wheel wobbles, it is out of true and will need repairing.

Repairing wheels requires special tools. It is recommended that all wheels are trued by qualified bike repair technicians. Contact your local retailer for more information on wheel repairs.

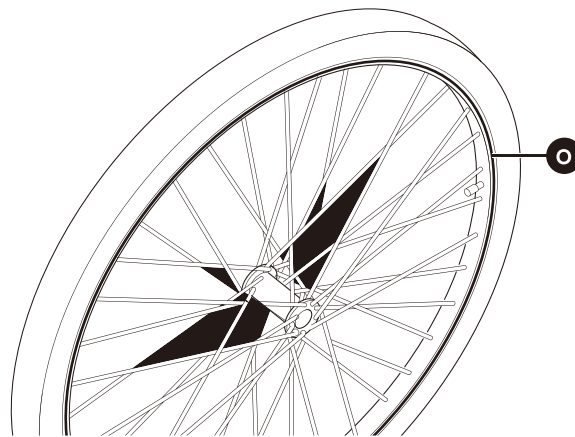

1b



1b. Inspect the Rim Wear



WARNING! If the wheel rim wear groove is no longer visible, the wheel rim should be replaced immediately. Do not attempt to ride the bike until the rim is replaced as the braking performance could be affected.

Each wheel features a wear groove  machined into the side of the rim. If the wear groove  is no longer visible, the wheel rim is worn and should be replaced immediately.

1c. Inspect the Wheel Bearings

Over the life of the bike, the wheel bearings may become worn and will need servicing.

To check the condition of the wheel bearing, grab the tyre of either the front or rear wheel while holding the bike securely. Vigorously move the tyre from side to side. If the wheel moves at the wheel hub (the centre of the wheel), the bearings may be worn.

Repairing bearings requires special tools. It is recommended that all bearings are repaired by qualified bike repair technicians. Contact your local retailer for more information on bearing repairs.

Maintenance | Instructions

Changing an Inner Tube

1a

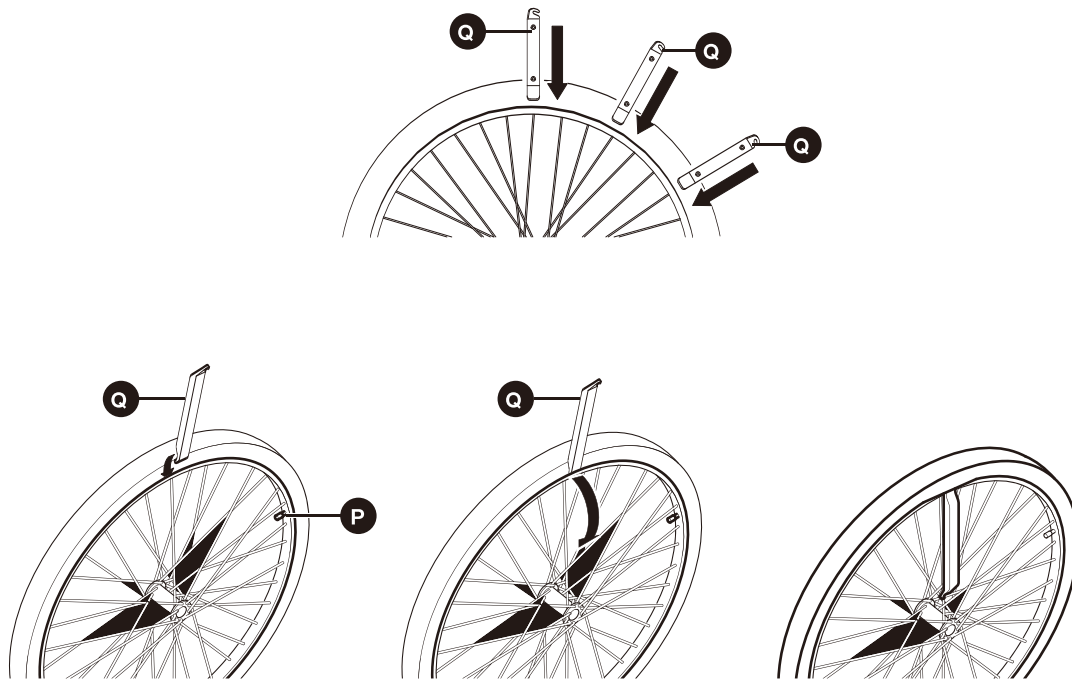

If you have a puncture, you will need to remove and repair the inner tube.



NOTE! To remove the inner tube you will need a set of tyre levers.

1a Removing the Tyre from the Wheel Rim

Unscrew the valve nut **P** from the inner tube valve. If required, deflate the tyre fully.

Using the thumb of one hand, depress the tyre opposite to the inner tube valve.



CAUTION! Be careful not to trap the inner tube between the tyre levers and the wheel.

Insert a tyre lever **Q** between the wheel rim and the tyre wall.

Pull downwards on the tyre lever **Q** and hook onto the nearest spoke.

Insert and secure the remaining two tyre levers at suitable points around the wheel rim.



NOTE! Do not leave too much space between tyre levers as the tyre may prove difficult to remove.

If it is not possible to fully remove the tyre from one side of the wheel rim, use the tyre levers as described above on another section of the wheel.

Maintenance Instructions

Changing an Inner Tube (continued)

1b. Remove the Inner Tube from the Tyre

Once the tyre is removed from one side of the wheel rim, carefully remove the inner tube starting with the valve.

1c. Replace the Inner Tube into the Tyre

Check the inner surfaces of the tyre for any signs of damage or foreign matter i.e. thorns or small stones. To check the rim tape make sure its in place and covering the spoke nipple heads.

Partially inflate the inner tube using a bicycle pump.

Carefully feed the inner tube into the tyre, starting with the valve. The valve must be repositioned through the appropriate hole in the wheel rim.

1d. Refit the Tyre to the Wheel Rim

Using the thumb of one hand, refit the tyre to the wheel rim a small section at a time. When the tyre is too tight to fit by hand, use the tyre levers to refit the last section.

Routine Maintenance

Before and After Each Ride

You should perform the following checks before riding your bike to ensure it is safe to use and operating correctly.

1. Is the Saddle Secure?

While standing next to the bike, try to move the saddle from side to side. If the saddle moves, you should retighten the seat post bolt or the saddle clamp bolts.

2. Are the Front and Rear Tyres Inflated Correctly?

Squeeze the sides of the front and rear tyres. If they are soft they will need inflating. Re-inflate to the pressure indicated on the sides of the tyres using an approved bicycle pump.

3. Are the Pedals Tight?

Using the supplied multi-tool, ensure both the left and right pedals are fully tight. Remember that the threaded shafts of the left and right pedals tighten in different directions. Right is clockwise and left side anti-clockwise.

4. Do the Brakes Work?

Stand next to the bike and apply the front brake and push forwards. If the wheels move, the front brake may not be working correctly. If required, adjust the front brake as described on pages 7-9.

Repeat the above check for the rear brake.

5. Do the Handlebars Move?

Hold the front wheel between your legs and move handlebars left to right to see if moves? If the handlebars move, the stem bolt may have become loose. Re-tighten the stem bolt.

6. Is the Bike Clean?

The bike should be cleaned and re-oiled regularly to ensure it operates correctly.

Every Month

You should perform the following checks once a month or after long rides.

1. Check that the bike is Clean and Suitably Lubricated.

Thoroughly clean and degrease your bike. Ensure the chain, gears, front derailleur and rear derailleur are adequately lubricated using a suitable bicycle lubricant.

It is important to wipe off any excess lubricant as this will attract dirt and may prevent the bike from operating correctly. Note: lubricant in wrong places and too much will be a disaster.

2. Check that all Parts of the Bike are Securely Fitted.

It is essential for your safety that the securing nuts and bolts are fully tightened and have not become loose. Pay particular attention to the pedals, wheel nuts, seat post bolt and the stem bolt.

While holding the bike with one hand, vigorously rock the crank arms and wheels. If you notice any movement, the bearings may be worn.

Repairing bearings requires special tools. It is recommended that all bearings are repaired by qualified bike repair technicians. Contact your local retailer for more information on bearing repairs.

Routine Maintenance

Every Month (continued)

3. Check that the Tyres are in Good Condition.

Check the outside of each tyre for signs of damage including cuts, deformation, excessive wear or bald spots.

If your tyre shows any signs of damage, it must be replaced immediately. Do not attempt to ride the bike with damaged tyres.

4. Check that the Wheel Spokes are Tight.

On each wheel check the tightness of the spokes. This can be done by gently squeezing two together at time. If you notice any movement, the spokes may need tightening.

Repairing wheels and tightening spokes requires specialist tools. It is recommended that all wheel spokes are tightened by qualified bike repair technicians. Contact your local retailer for more information on wheel repairs.

Every Six Months

1. Check the Frame and Forks for Signs of Damage.

Thoroughly check all the external surfaces of the frame and suspension forks for signs of damage. This may include cracks, dents or bent mounting points.

If the frame or suspension forks are damaged, do not attempt to ride the bike until it has been inspected by a qualified bicycle technician.

2. Check that the Wheels are Running True.

Check the trueness of both the front and rear wheels as described on page 10.

3. Check the Condition of the Brake Pads.

Check all brake pads for signs of limit wear lines. Replace badly worn brake pads immediately.

4. Check the Front and Rear Gears for Signs of Damage.

Check the front and rear gears for signs of damage and/or limit wear lines. If any of the teeth on a gear are chipped or missing, the chain may be prone to slipping. Replace the gear as soon as possible.

Every Twelve Months

It is recommended that the bike is serviced by a suitably qualified bike technician every 12 months.

Make the replacement of the inner tube, tyre and brake pads which are the most vulnerable components of a bicycle or contact Customer Care for help.

Routine Maintenance

Lubrication Information

Frequency	Component	Lubricant	How to Lubricate
Weekly	Chain Deraileur wheels Deraileurs Brake calipers Brake levers	Chain lube or light oil Chain lube or light oil Oil Oil Oil	Brush on or squirt Brush on or squirt Oil can 3 drops from oil can 2 drops from oil can
Monthly	Shift levers	Lithium based grease	
Every Six Months	Freewheel Brake cables	Oil Lithium based greas	2 squirts from oil can Disassemble
Yearly	Bottom bracket Pedals Deraileur cables Wheel bearings Headset Seat pillar	Lithium based greas Lithium based greas Lithium based greas Lithium based greas Lithium based greas Lithium based greas	Disassemble Disassemble Disassemble Disassemble

NOTE: The frequency of maintenance should increase with use in wet or dusty conditions. Do not over lubricate- remove excess lubricant to prevent dirt build up. Never use a degreaser to lubricate your chain(WD-40™).

! **WARNING:** Do not over lubricate. If lubricant gets on rims, tires or brake shoes, it will reduce control and braking performance and may require a longer stopping distance. Injury to the rider can occur. Avoid getting any excess lubrication on these area by wiping off excess lubricant, and keeping these areas clean and dry.

Recommended tightening information

Part	Torque (Nm)
Front Wheel Nuts	22-25 Nm
Rear Wheel Nuts	25-29 Nm
Handlebar Clamp Nuts	16-18 Nm
Stem Bolt	18-20 Nm
Seat Clamp Bolt or Nuts	16-18 Nm
Seat Post Clamp Allen Bolt	8-10 Nm
Brake Cable Pinch Bolt	6-8 Nm
Crank Bolt or Nut	45 Nm
Pedals	40-45 Nm
V-Brake Brake Blocks	8-10 Nm