

Newbury King Bed Frame

Assembly Instructions - Please keep for future reference

424/6585

618/5510



Heart of House

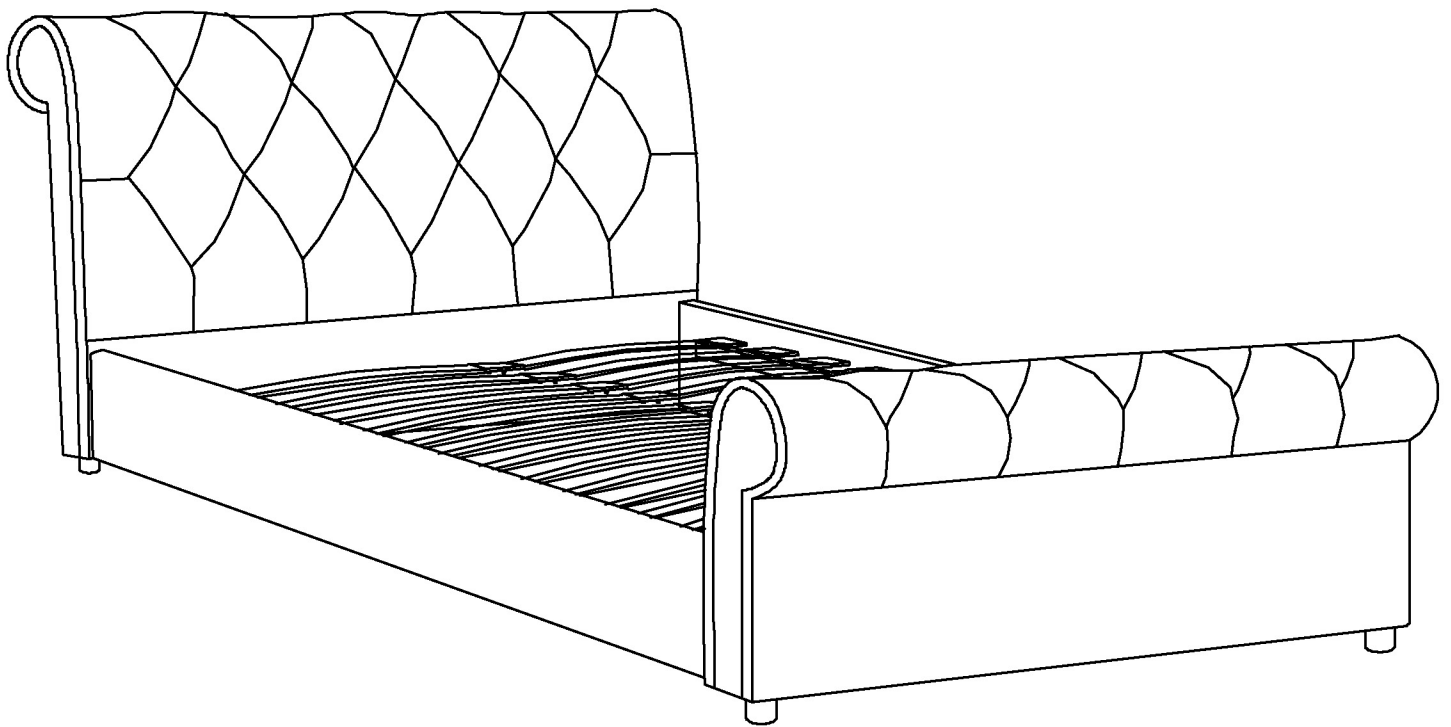

Dimensions

Width x Depth x Height
239.5cm x 164.5cm x 93.5cm (king)

Important - Please read these instructions fully before starting assembly

If you need help or have damaged or missing parts, call the Customer Helpline:
Argos = 0345 6400800



Safety and Care Advice

Important – Please read these instructions fully before starting assembly

- Check you have all the components and tools listed on pages 2 and 3.
- Remove all fittings from the plastic bags and separate them into their groups.
- Keep children and animals away from the work area, small parts could choke if swallowed.
- Make sure you have enough space to layout the parts before starting.

- Assemble the item as close to its final position (in the same room) as possible.
- Assemble on a soft level surface to avoid damaging the unit or your floor.
- Assembly requires 2 people.
- Do not fully tighten bolts until the whole bed is assembled. Do not overtighten the nuts to avoid causing damage to the threads.



- We do not recommend the use of power drill/drivers **for inserting bolts and screws**, as this could damage the unit. Only use hand screwdrivers and Allen keys.
- Dispose of all packaging carefully and responsibly.

Care and maintenance

- Only clean using a damp cloth and mild detergent, do not use bleach or abrasive cleaners.
- From time to time check that there are no loose bolts or screws on this unit.
- This product should not be discarded with household waste. Take to your local authority waste disposal centre.

Handy Hints

- Assemble all parts and bolts loosely during assembly, only once the product is complete should you fully tighten the bolts.
- Regularly check and ensure that all bolts and fittings are tightened properly.

Note: if required the next page can be cut out and used as reference throughout the assembly. Keep this page with these instructions for future reference.

Components

If you need help or have damaged or missing parts, call the
Customer Helpline: Argos = 0345 6400800

Please check you have all the parts listed below

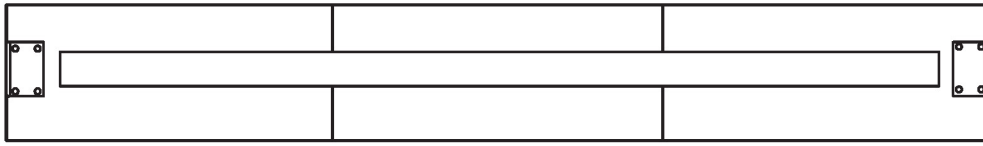

1 Right side rail

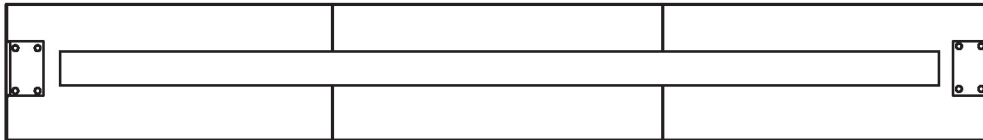

2 Left side rail

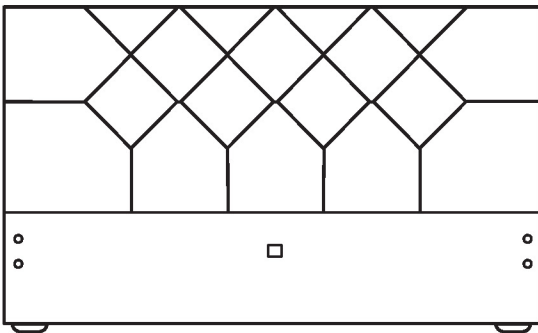

3 Headboard

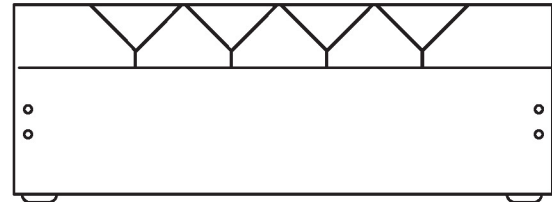

4 Footboard



5 Central support rail

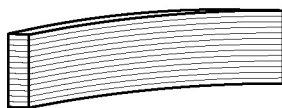







6 Slats x 2



Components - Fittings

Please check you have all the fittings listed below

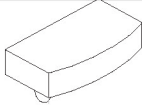
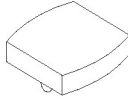
Note: The quantities below are the correct amount to complete the assembly. In some cases more fittings may be supplied than are required.

<p>A</p>  <p>Bolts (18mm) x 8</p>	<p>B</p>  <p>Bolts (40mm) x 2</p>	<p>C</p>  <p>Bolts (20mm) x 4</p>
<p>D</p>  <p>Washers x 6</p>	<p>E</p>  <p>M5 Allen key x 1 (supplied)</p>	<p>F</p>  <p>End slat caps x 28</p>
<p>G</p>  <p>Central slat caps x 14</p>	<p>H</p>  <p>Feet x 4</p>	<p>I</p>  <p>Feet x 2</p>

Tools required

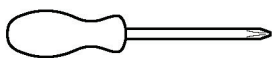

Phillips screwdriver

Ruler - Use this ruler to help correctly identify the screws



Assembly Instructions

Step 1

Attaching feet

Attach 2 x feet **H** to the underside of the headboard **3**

Repeat on the underside of the footboard **4**.

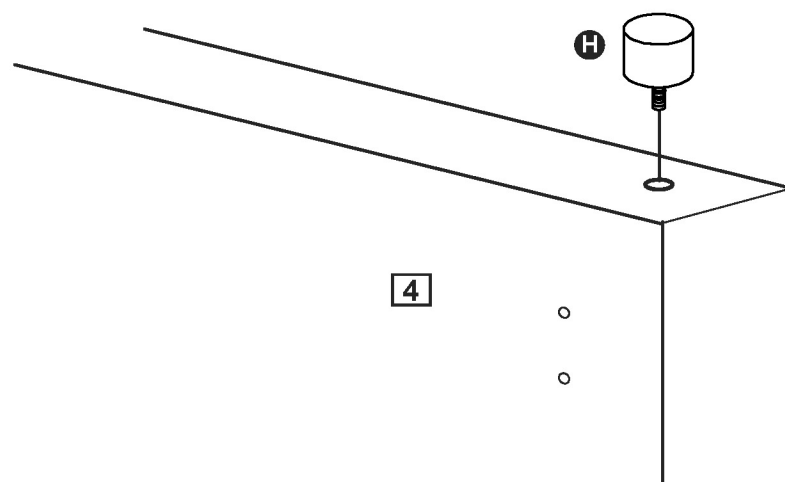
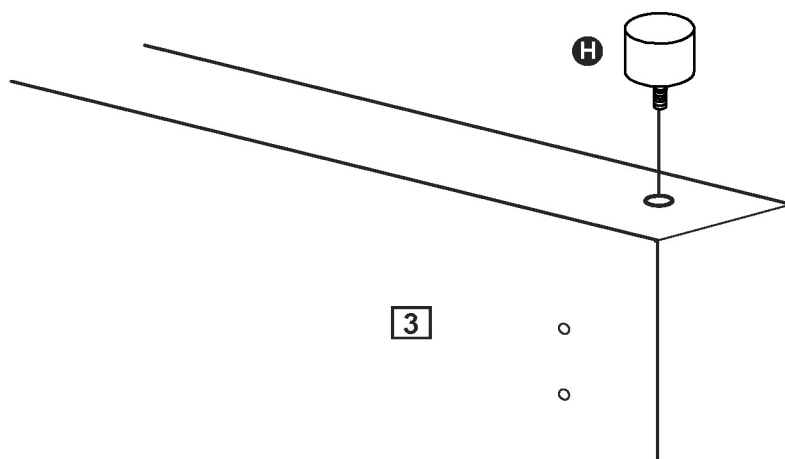

Assembly Instructions

Step 2

Attaching side rails

a: Attach 2 bolts **A** to the headboard **3** and footboard **4** using the Allen key **E** provided.

a:

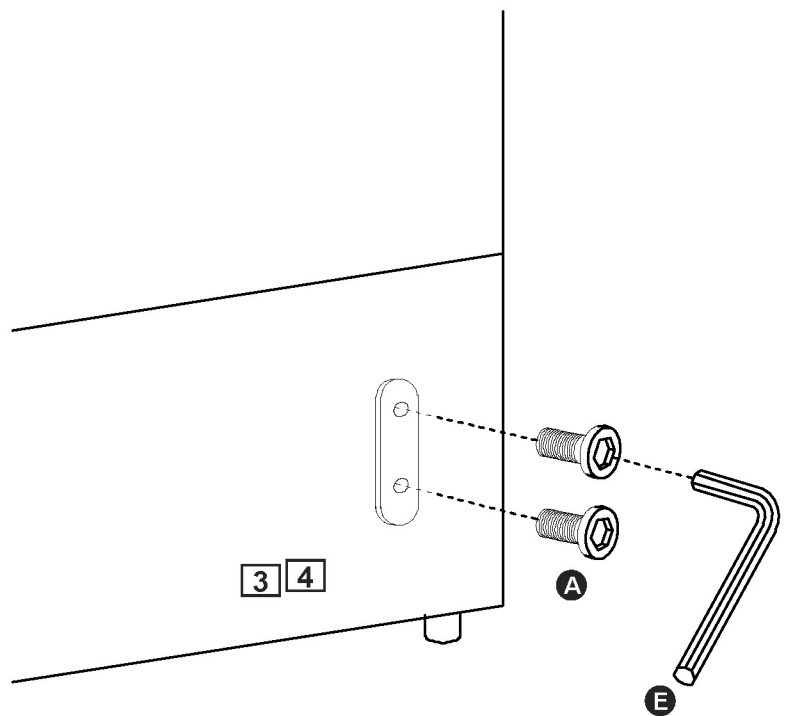

b: Position left side rail **2** adjacent to headboard **3** & **4** so that the holes in the headboard line up with the bracket on the side rail.

Secure in place by 2 bolts **A** using the Allen key provided.

Repeat b for right side rail **1**.

Do not fully tighten at this stage.

b:

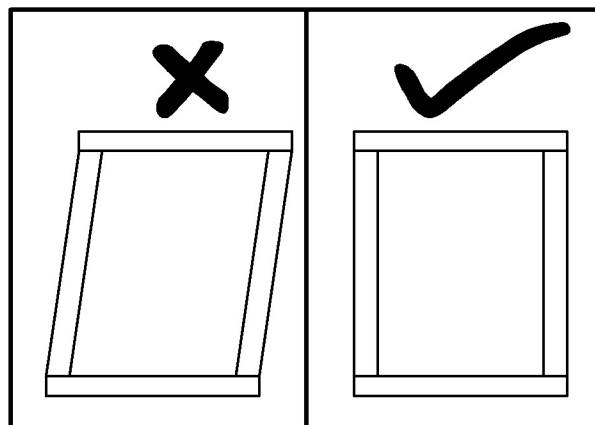
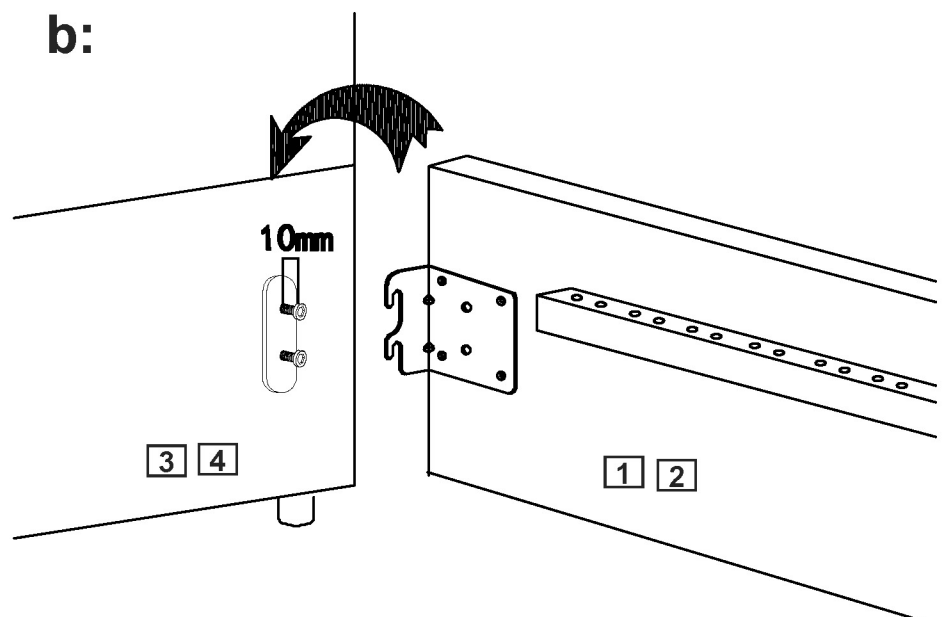

Assembly Instructions

Step 3

Central support assembly

Insert the feet **I** into the holes on the central support rail **5** and secure using bolts **B** and washers **D**.

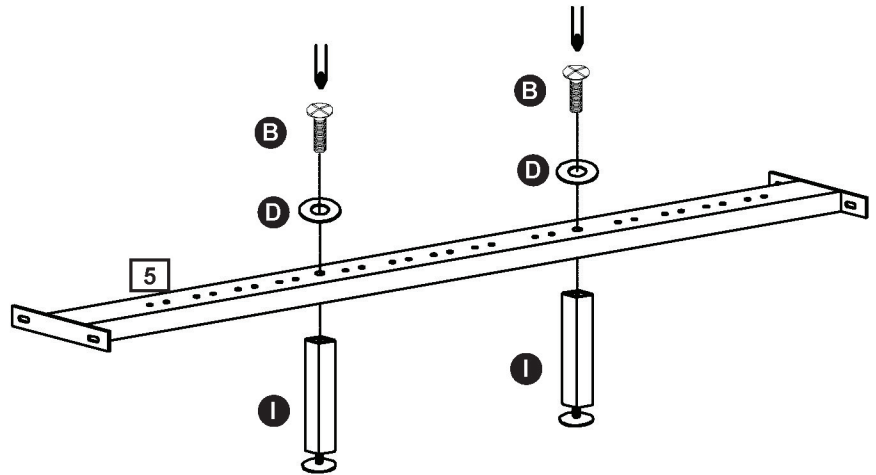

Step 4

Attach central support

Secure the central support rail **5** to the headboard **3** using bolt **C** and washers **D**.

Repeat at the footboard end.

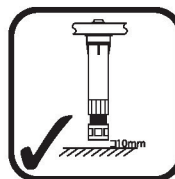
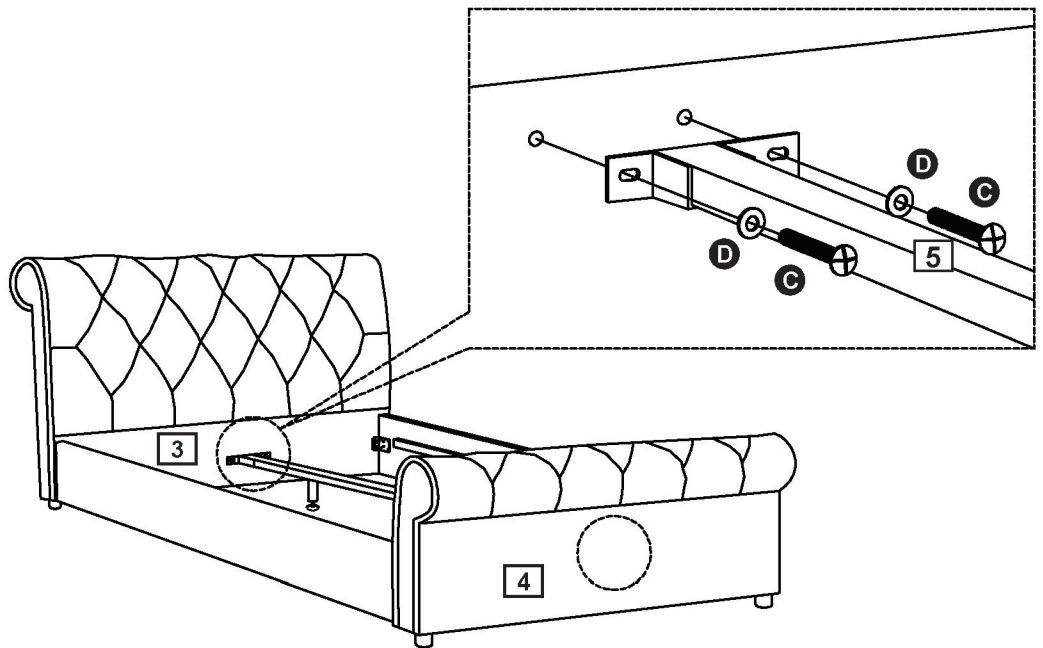

Warning

adjust the feet so that they are not in contact with the floor when the mattress is in place. There should be a 10mm (½ inch) gap.

Assembly Instructions

Step 5

Place slats

a: Slot the bed slats **6** into the end slat caps **F** and central slat caps **G** as shown.

a:

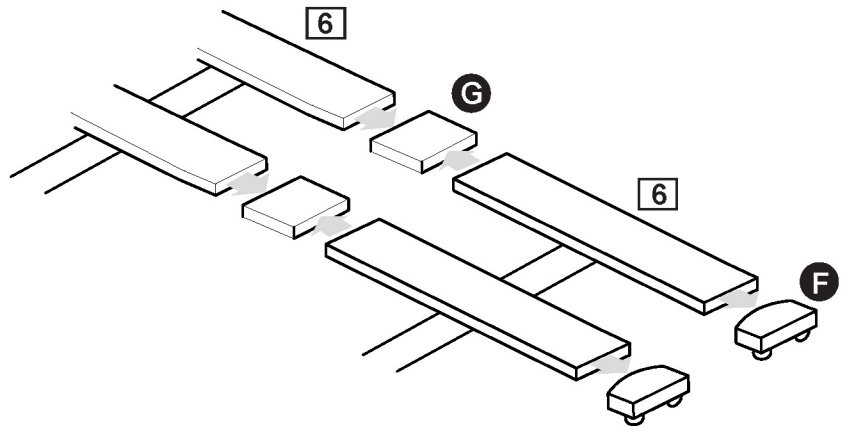

b: Attach the slats to the side rails **1** & **2** and central support rail **5** by firmly pushing into place.

After all the parts are positioned you can now fully tighten all bolts fixed on previous steps.

Assembly is complete.

b:

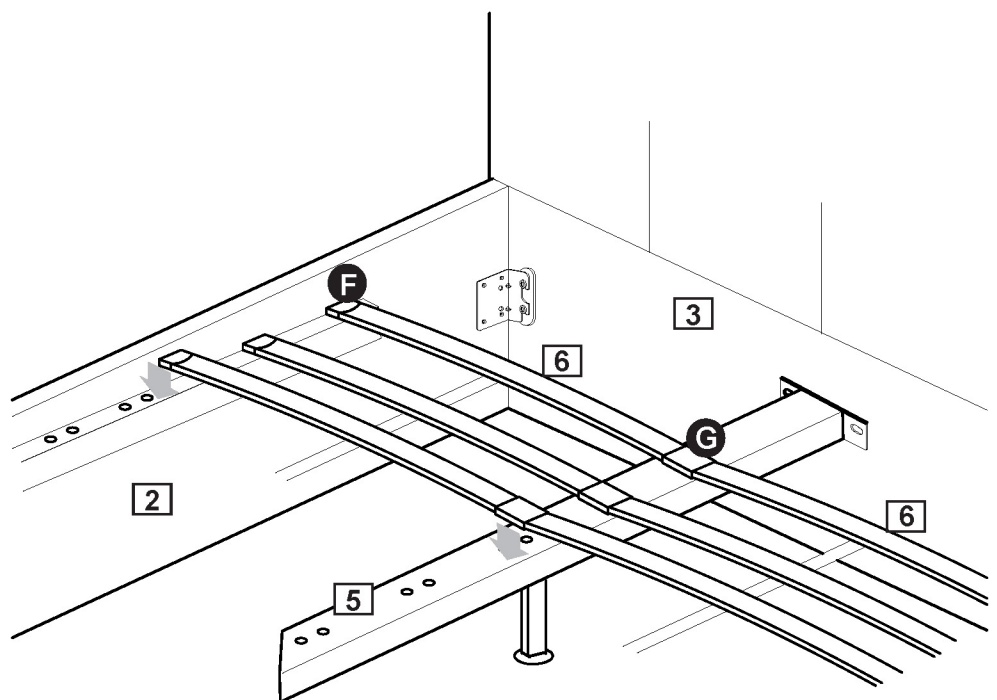

If you need help or have damaged or missing parts, call the **Customer Helpline:**
Argos = 0345 6400800