

FITZ END TABLE

Assembly Instructions - Please keep for future reference

618/4425

hygena

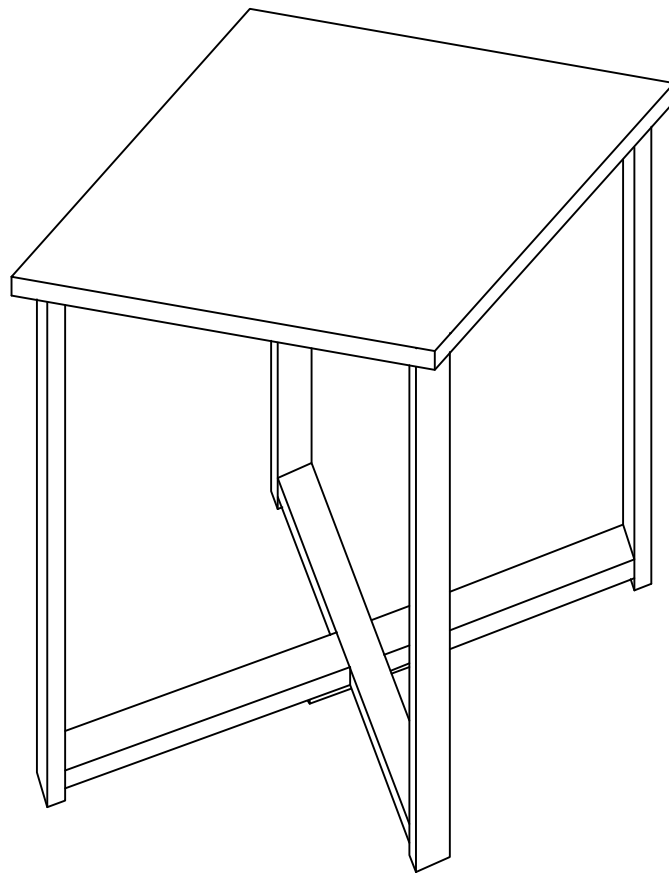

DIMENSIONS

Width: 35 cm

Depth: 35 cm

Height: 55 cm

Important – Please read these instructions fully before starting assembly

If you need help or have damaged or missing parts, call the Argos Aftersales
Helpline: 0345 640 0800



Safety and Care Advice

Important – Please read these instructions fully before starting assembly

- Check you have all the components and tools listed on pages 2 and 3.
- Remove all fittings from the plastic bags and separate them into their groups.
- Keep children and animals away from the work area, small parts could choke if swallowed.
- Make sure you have enough space to layout the parts before starting.

- Do not stand or put weight on the product, this could cause damage.
- Assemble the item as close to its final position (in the same room) as possible.
- Assemble on a soft level surface to avoid damaging the unit or your floor.
- Parts of the assembly will be easier with 2 people.



- To reduce the likelihood of damaging your product, please ensure that your power drill is set on a low torque setting.

Care and maintenance

- Only clean using a damp cloth and mild detergent, do not use bleach or abrasive cleaners.
- From time to time check that there are no loose screws on this unit.
- This product should not be discarded with household waste. Take to your local authority waste disposal centre.

Handy Hints

- Assemble all parts and bolts loosely during assembly, only once the product is complete should you fully tighten the bolts
- Regularly check and ensure that all bolts and fittings are tightend properly.

Note: if required the next page can be cut out and used as reference throughout the assembly. Keep this page with these instructions for future reference.

Components - Panels

Please check you have all the panels listed below

1 Table top
(35 x 35 cm)

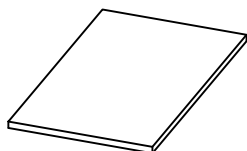

2 Leg
(45.6 x 53 cm)

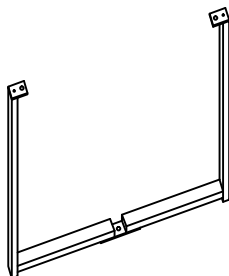

3 Leg
(45.6 x 53 cm)



Components - Fittings

Please check you have all the fittings listed below

Note: The quantities below are the correct amount to complete the assembly. In some cases more fittings may be supplied than are required.

A



Bolt (Ø6 x 12mm) x 5

B



Allen key (68 x 25mm) x 1

Tools required

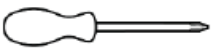

Crosshead screwdriver
(medium & large)

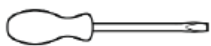

Flatblade screwdriver
(medium)



Small
hammer



Ruler/tape
measure



Eye protection
(when using a
hammer or glue)

Ruler - Use this ruler to help correctly identify the screws



Assembly Instructions

Step 1

Unfolding and folding the table

a: Attach leg **2** to leg **3** by using screw **A**.

a:

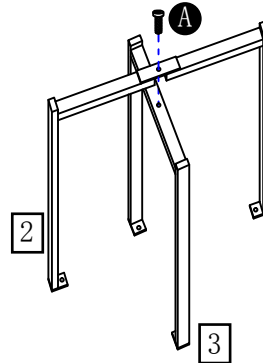

b: Attach the table top **1** to the assembled leg by using screw **A**.

b:

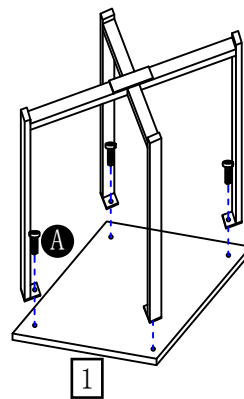

Assemble is complete.

