

Matrix - Glass Bookcase

Assembly Instructions - Please keep for future reference

613/2446

613/4028

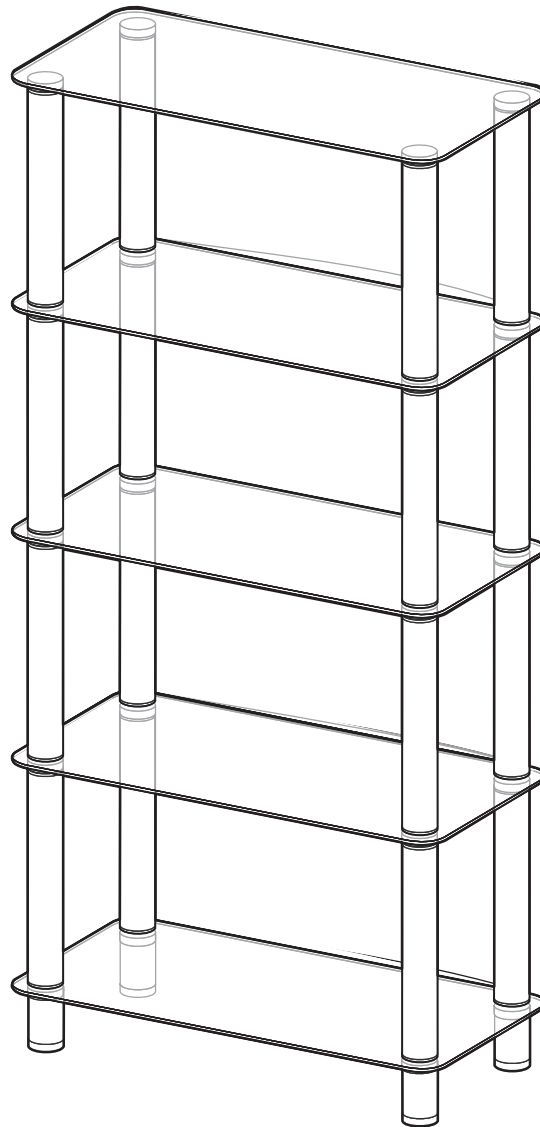

Dimensions

Width - 70cm

Depth - 35cm

Height - 145cm

Important - Please read these instructions fully before starting assembly

If you need help or have damaged or missing parts, call the Customer Helpline: 08456 400800



Safety and Care Advice

Important - Please read these instructions fully before starting assembly

- Check you have all the components and tools listed on pages 2.
- Remove all fittings from the plastic bags and separate them into their groups.
- Keep children and animals away from the work area, small parts could choke if swallowed.
- Make sure you have enough space to layout the parts before starting.

- Do not stand on the product, this could cause damage.
- Assemble the item as close to its final position (in the same room) as possible.
- Assemble on a soft level surface to avoid damaging the unit or your floor.
- Parts of the assembly will be easier with 2 people.



- We do not recommend the use of power drill/drivers for inserting screws, as this could damage the unit. Only use hand screwdrivers.
- Dispose of all packaging carefully and responsibly.

Care and maintenance

- Only clean using a damp cloth **and mild detergent, do not use bleach or abrasive cleaners.**
- From time to time check that **there are no loose screws on this unit.**
- This product should not be **discarded with household waste. Take to your local authority waste disposal centre.**

Keep These Instructions For Future Reference

- This product complies with BS EN 14749:2005
- Argos plc
489-499 Avebury Boulevard
Central Milton Keynes
MK9 2NW
- Batch No./Date of manufacture:

Warning

- Do not place very hot or very cold items against or in close proximity to glass surfaces unless an adequately thick insulating material is used to prevent such items from coming into contact with the glass.
- Do not sit or stand upon the glass surface(s).
- If a glass component is chipped or broken, stop using the product and consult the manufacturer or supplier.
- Do not use the glass as a chopping surface. Do not strike the glass with hard or pointed items.

Components - Panels

Please check you have all the panels listed below

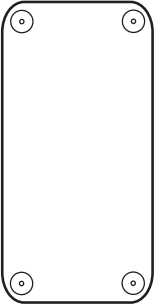

1 Glass top
(70 x 35cm)



2 Metal rod x 4
(69 x 0.6cm)



3 Metal tube x 16
(33.1 x 5 cm)

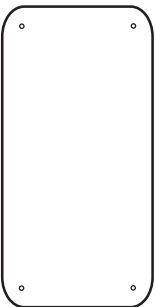

4 Glass shelf x 4
(70 x 35cm)



5 plastic pad x 32
(5x1.4cm)



6 Connect x 4
(2 x 1.2cm)



7 Metal rod x 4
(74.4x 0.6cm)



8 Metal tube x 4
(8.5 x 5 cm)



9 Feet x 4
(1.4 x 5 cm)



Components - Fittings

If you have damaged or missing components, call the **Customer Helpline**: 08456 400800

Please check you have all the fittings listed below

Note: The quantities below are the correct amount to complete the assembly. In some cases more fittings may be supplied than are required.



Wall mounting strap x 2

Tools required

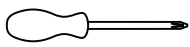

Screwdriver
(not included)

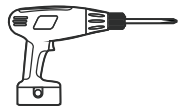

Drill
(not included)

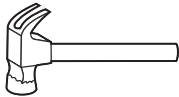

Hammer
(not included)

Ruler - Use this ruler to help correctly identify the screws

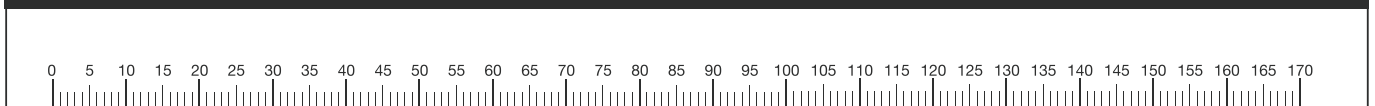

Assembly Instructions

Step 1

Fitting Metal Rod

Finger tighten 4 pcs of metal rods **2** onto glass top **1** as shown.

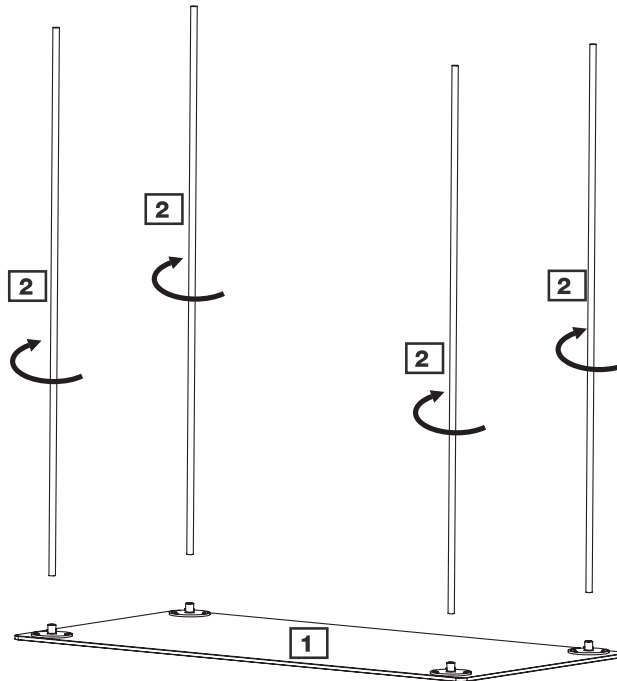

Step 2

Fitting Wall Straps

Put 2 pcs wall strap **A** through metal rods **2** as shown.

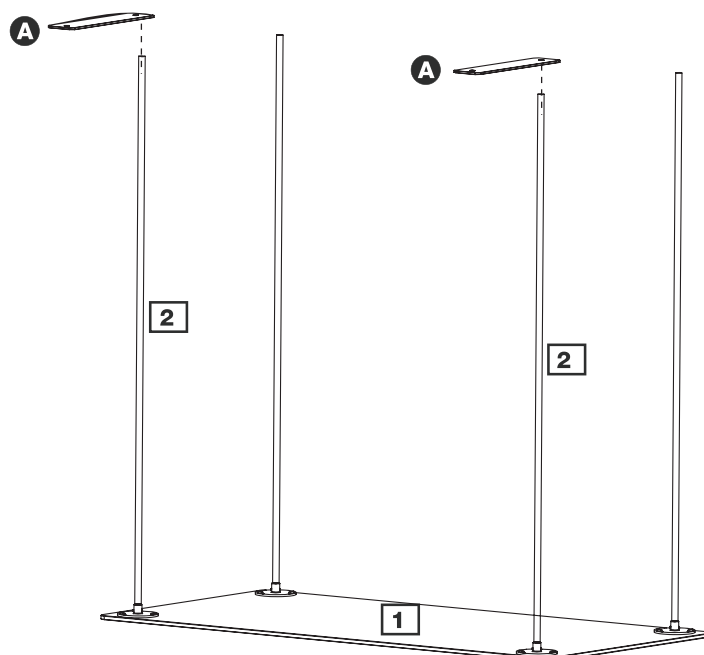

Assembly Instructions

Step 3

Fitting Metal Tube

Attach 4 pcs of metal tubes **3** and 4 pcs of plastic pad **5** through 4 pcs of metal rods **2** as shown.

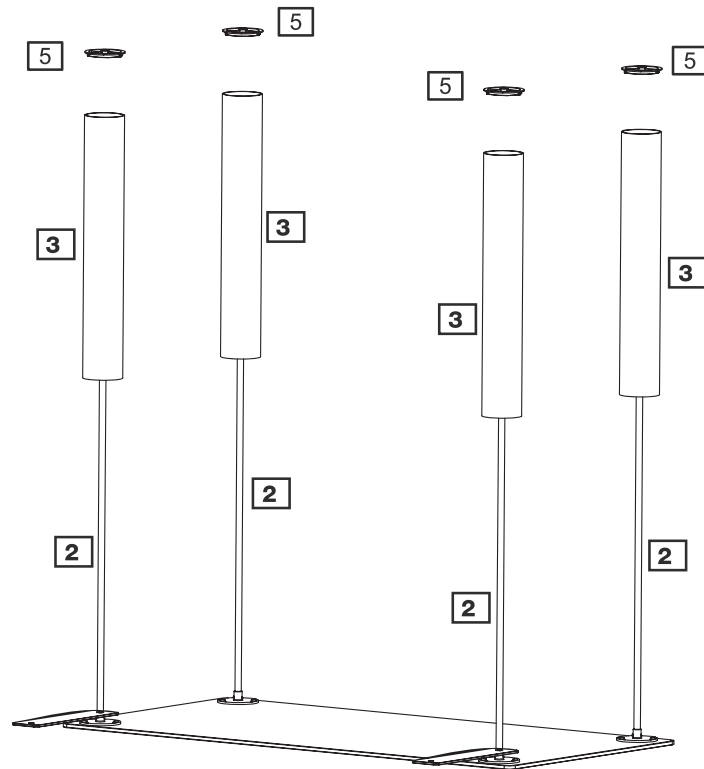

Matt surface

Step 4

Attaching Glass Shelf

Please be careful to place glass shelf **4** through 4 pcs of metal rods **2** as shown.

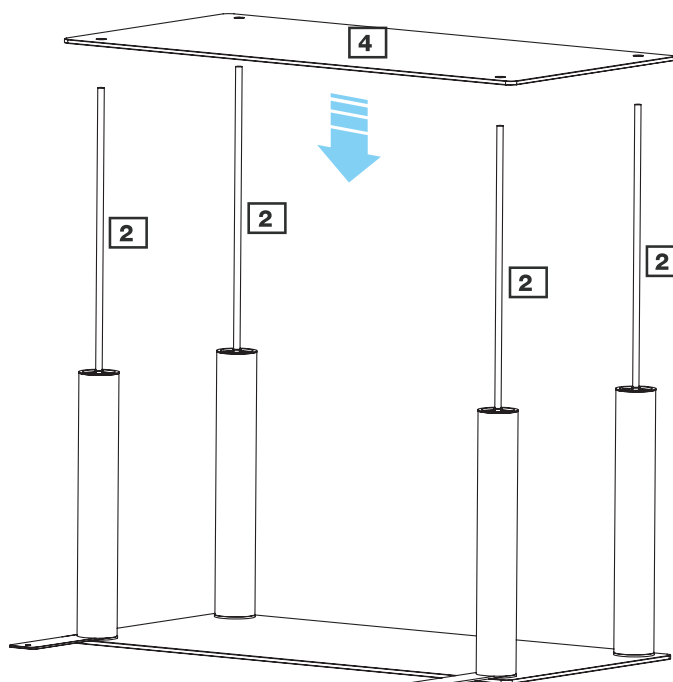

Assembly Instructions

Step 5

Fitting Metal Tube

Attach 4 pcs of metal tubes **3** and 8 pcs of plastic pad **5** through 4 pcs of metal rods **2** as shown.

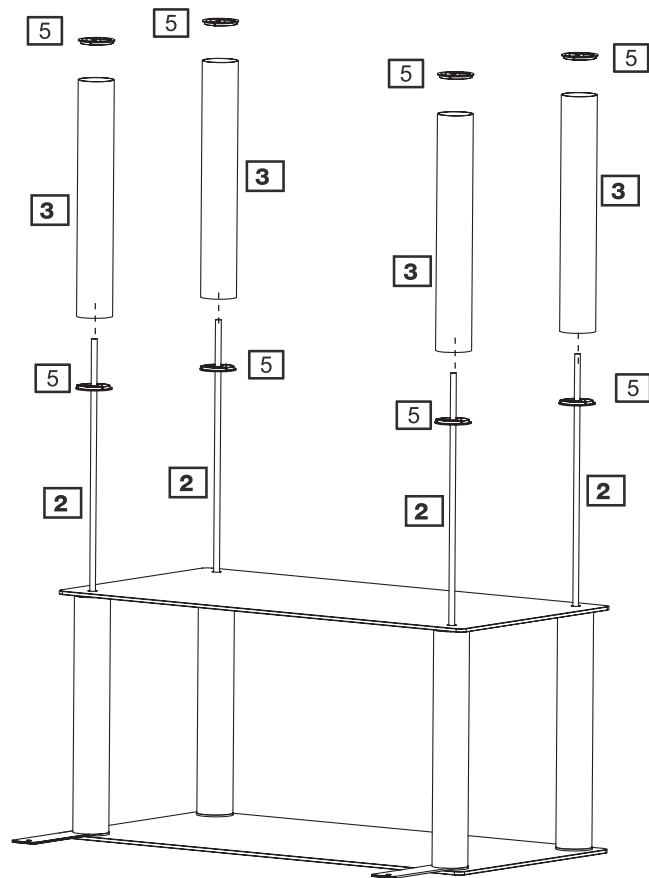

Step 6

Attaching Glass Shelf

Please be careful to place glass shelf **4** through 4 pcs of metal rods **2** as shown.

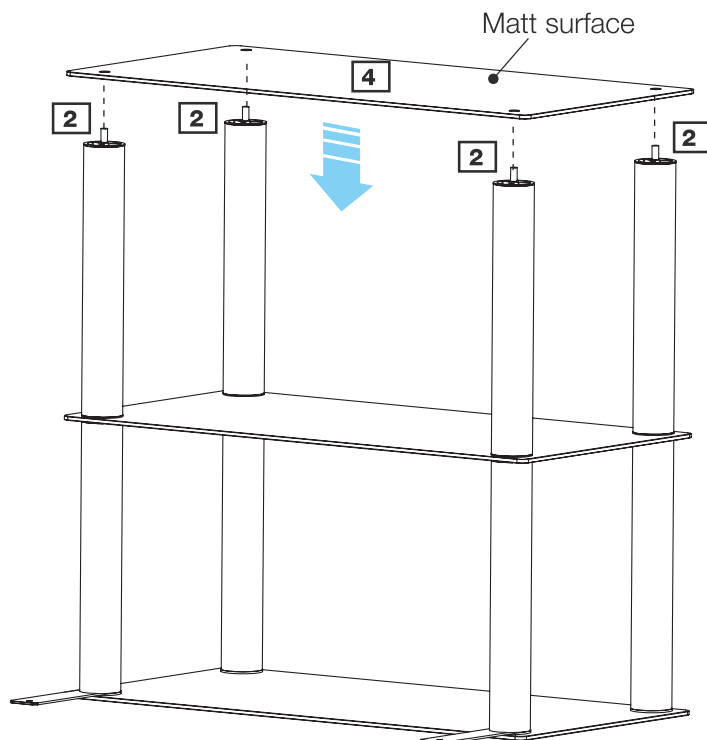

Assembly Instructions

Step 7

Fitting Cap

Attach 4 pcs of plastic pad **5** through 4 pcs of metal rods **2** as shown.

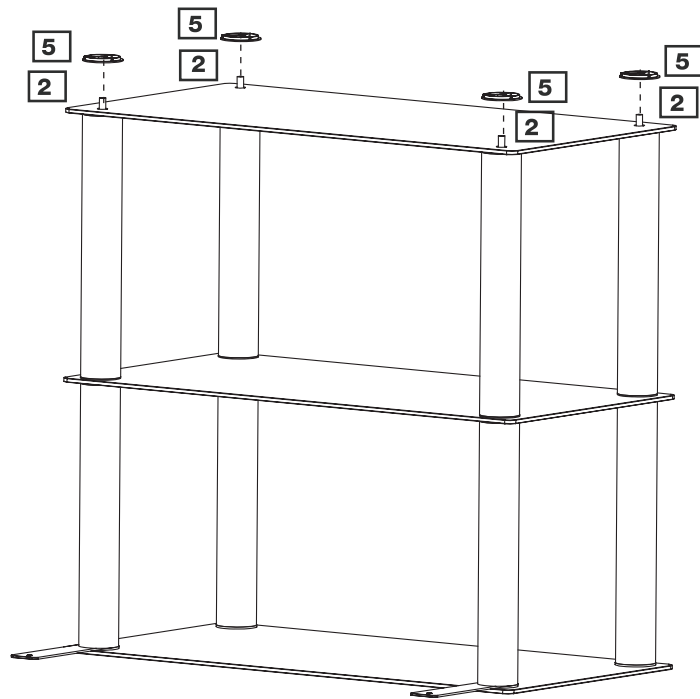

Step 8

Fitting connect tube

Screw connect tubes **6** halfway down onto metal rods **2** as shown.

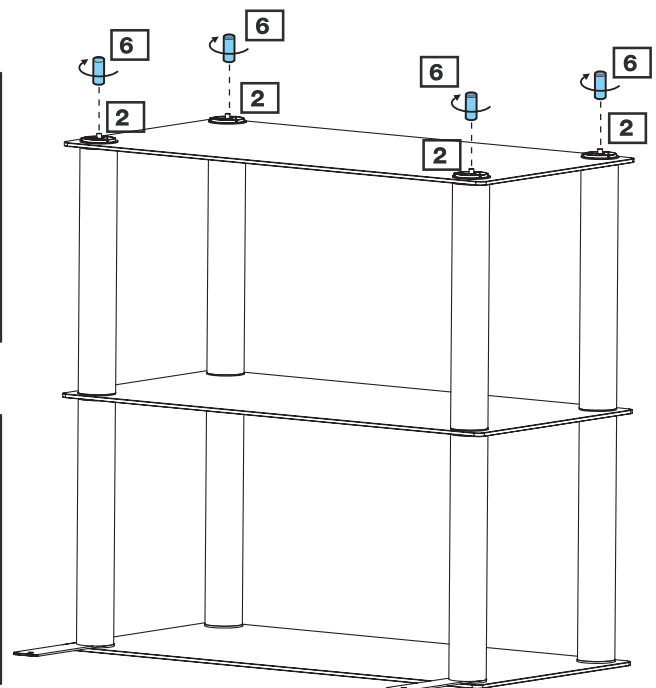
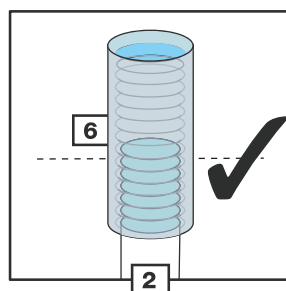
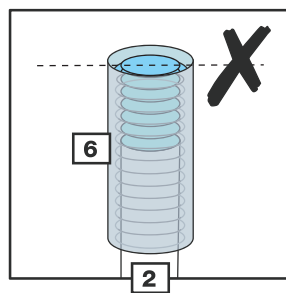

Assembly Instructions

Step 9

Fitting Metal Rod

Finger tighten 4 pcs of metal rods **7** into connect tubes **6**.

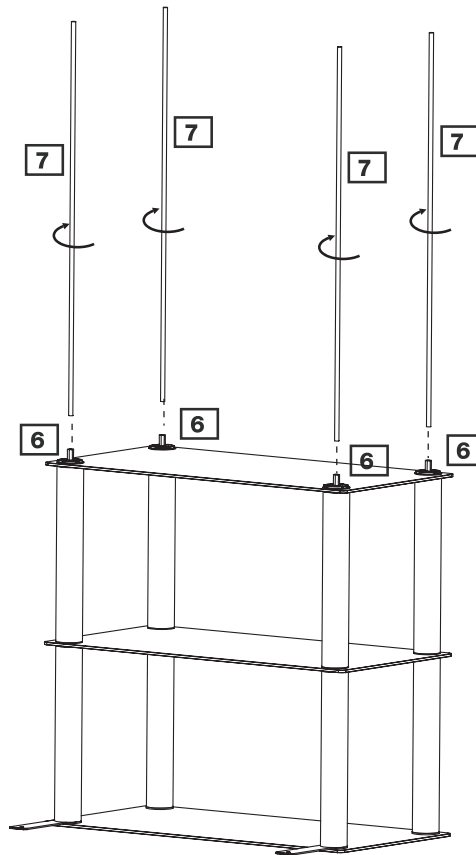

Step 10

Fitting Metal Tube

Attach 4 pcs of Metal Tubes **3** and 4 pcs of plastic pad **8** through 4 pcs of metal rods **7** as shown.

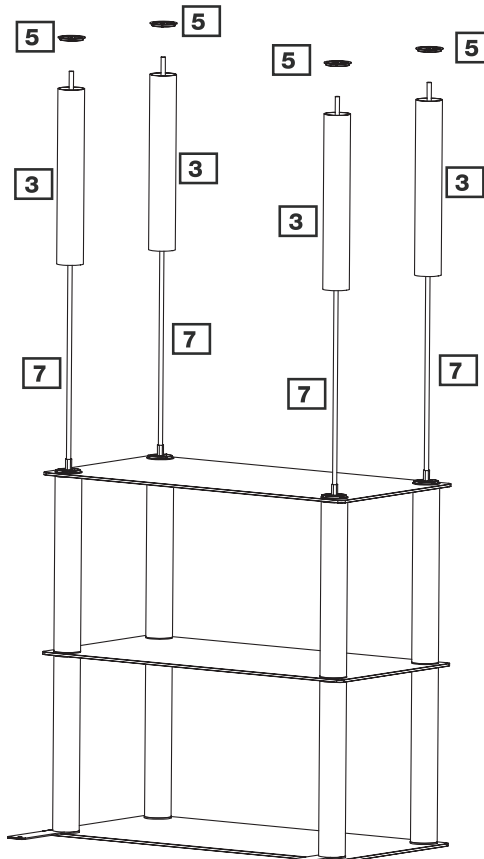

Assembly Instructions

Step 11

Attaching Glass Shelf

Please be careful to place glass shelf **4** through 4 pcs of metal rods **7** as shown.

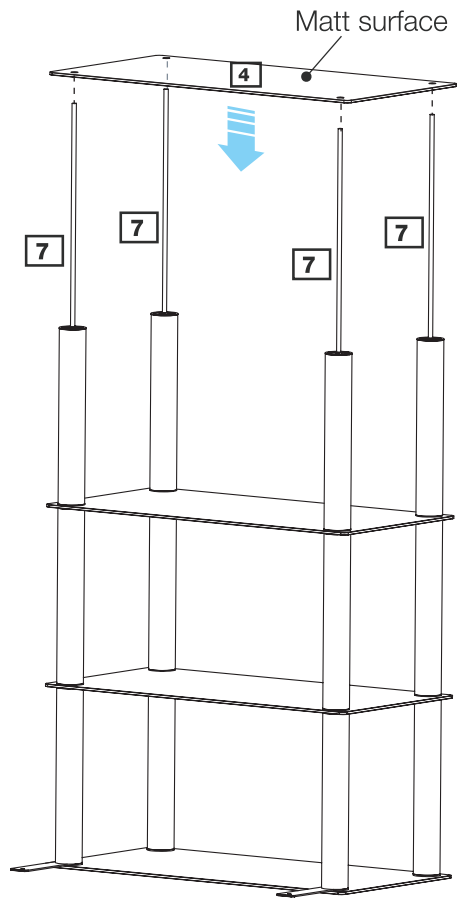

Step 12

Fitting Metal Tube

Attach 4 pcs of Metal Tubes **3** and 8 pcs of plastic pad **5** through 4 pcs of metal rods **7** as shown.

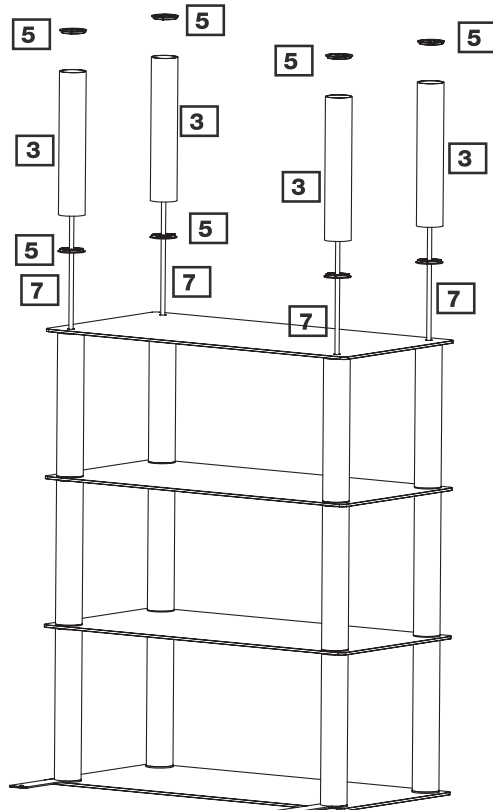

Assembly Instructions

Step 13

Attaching Glass Shelf

Please be careful to place glass shelf **4** through 4 pcs of metal rods **7** as shown.

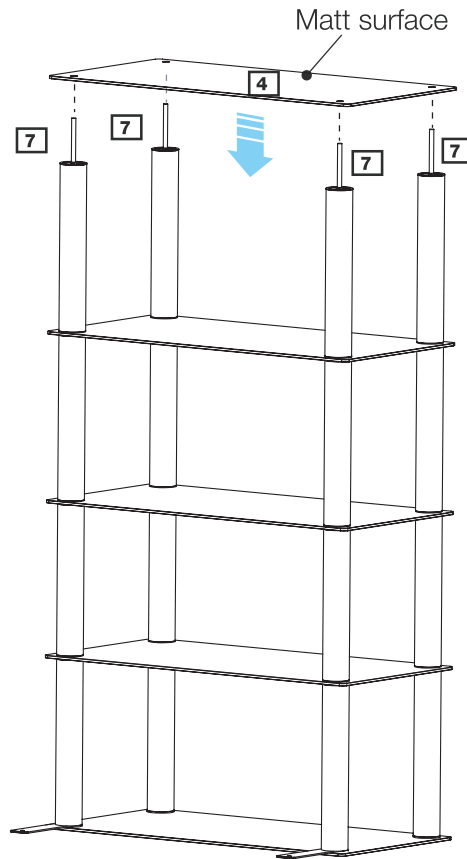

Step 14

Fitting Metal Tube

Attach 4 pcs of Metal Tubes **8** and 4 pcs of plastic pad **8** through 4 pcs of metal rods **7** as shown.

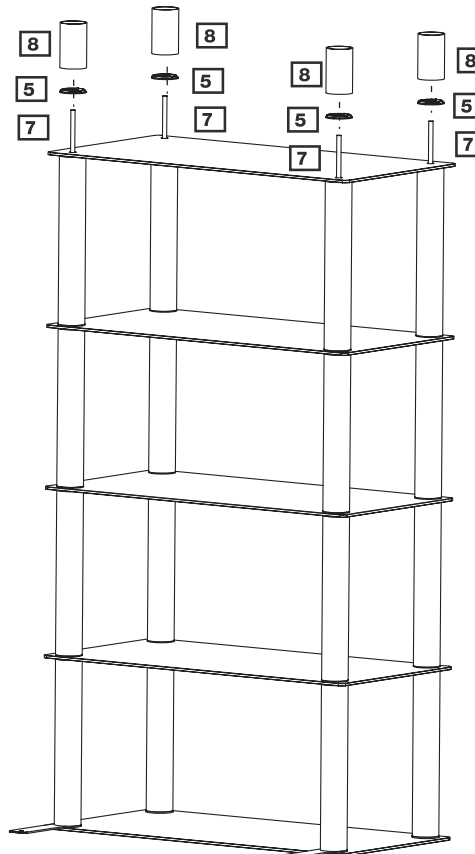

Assembly Instructions

Step 15

Tighten Feet

Tighten 4 pcs of feet **9** onto the unit by hand as shown.



Warning:
The unit is heavy.
Lift with care.

Turn the unit 180° upside down, prepare for Step 16.

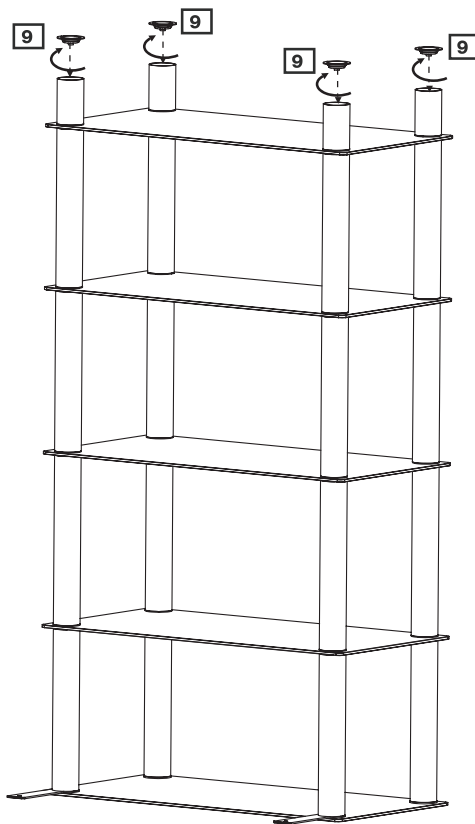

Step 16

Adjust Wall Strap

Straighten up the wall strap **A** as shown.

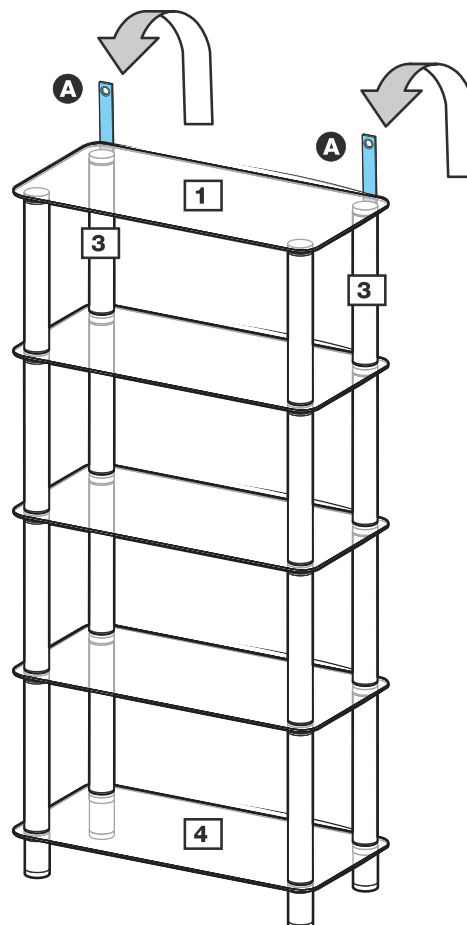
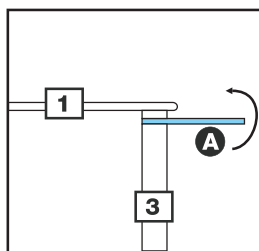

Assembly Instructions

Step 17

Fixing to wall

It is recommended that the unit is fixed to a wall.

Fix wall strap to top of the unit by using screw.

With help, move the unit into position.



Warning:

The unit is heavy.

Lift with care.

Mark fixing hole on wall and remove the unit.

Drill 6mm hole and insert wall plug.



Warning:

Before drilling, check wall for hidden pipes and cables.

Reposition the unit and fix wall strap by using screw.

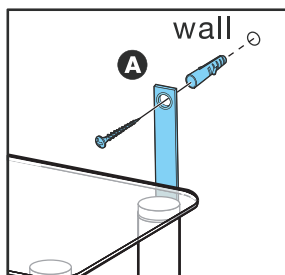

Note: Wall plug supplied are for solid wall only.

The correct type of fixing must be used for your wall, seek professional advice if in doubt.

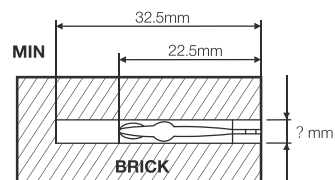
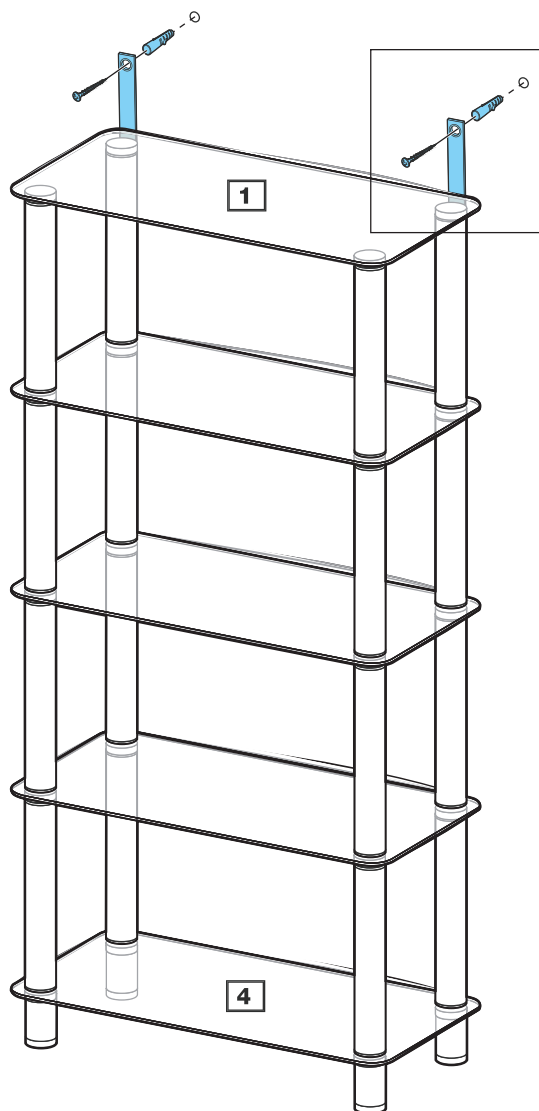

If you need help or have damaged or missing parts, call the
Customer Helpline: 08456 400800