

2 Drawers/Tall/Wide/Extra Deep Bookcase

Assembly Instructions - Please keep for future reference

609/2555

609/3578

609/4694

609/5765

339/4146

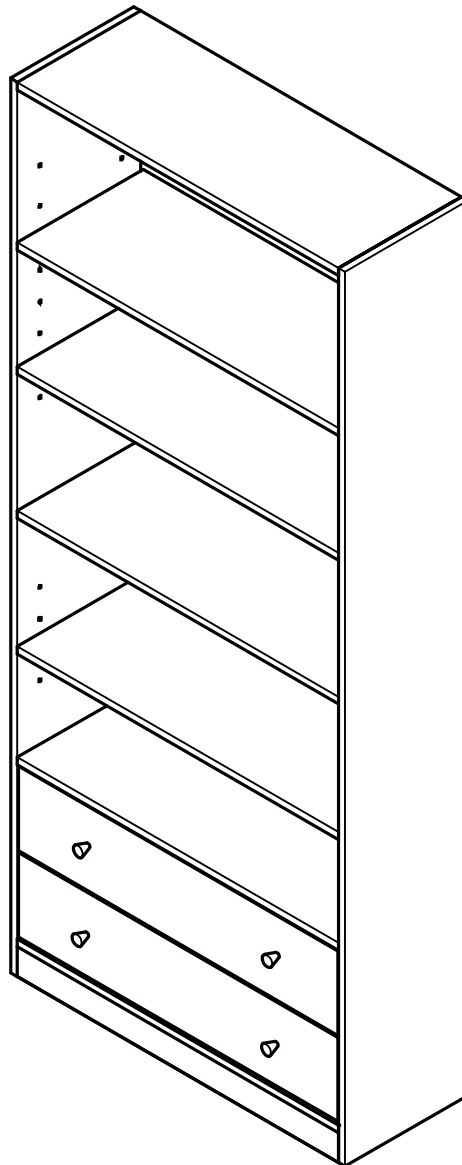

Dimensions

Width - 78cm

Depth - 29cm

Height - 180cm

Important - Please read these instructions fully before starting assembly

If you need help or have damaged or missing parts, call the **Customer Helpline:**
Argos = 0345 6400800



Safety and Care Advice

Important – Please read these instructions fully before starting assembly

- Check you have all the components and tools listed on the following pages.
- Remove all fittings from the plastic bags and separate them into their groups.
- Keep children and animals away from the work area, small parts could choke if swallowed.
- Make sure you have enough space to layout the parts before starting.

- During assembly do not stand or put weight on the product, this could cause damage.
- Assemble the item as close to its final position (in the same room) as possible.
- Assemble on a soft level surface to avoid damaging the unit or your floor.
- Parts of the assembly will be easier with 2 people.



power drill is set on a low torque setting.

- To reduce the likelihood of damaging your product please ensure that your

Glue safety - Take care when using glue, please follow the advice below

Skin contact: Remove contamination by washing with soap and water. This procedure should also be followed prior to eating and drinking.

Eye contact: Rinse immediately with clean water for 15 minutes and seek medical advice.

If swallowed: Seek medical advice immediately.

Care and maintenance

• Only clean using a damp cloth and mild detergent, do not use bleach or abrasive cleaners.

• From time to time check that there are no loose screws on this unit.

• This product should not be discarded with household waste. Take to your local authority waste disposal centre.

Handy Hints

• Assemble all parts and bolts loosely during assembly, only once the product is complete should you fully tighten the bolts

• Regularly check and ensure that all bolts and fittings are tightend properly.

Note: if required the next page can be cut out and used as reference throughout the assembly. Keep this page with these instructions for future reference.

Components - Panels

If you have damaged or missing components, call the Customer Helpline: Argos = 0345 6400800

Please check you have all the panels listed below



1 Fixed panel x 2 (74.9 x 28.4cm)



2 Middle panel (74.9 x 28.4cm)



3 Shelf x 3 (74.9 x 28.4cm)

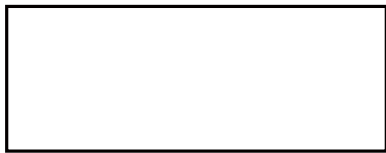

4 Drawer bottom panel x 2 (72.6 x 23.6cm)

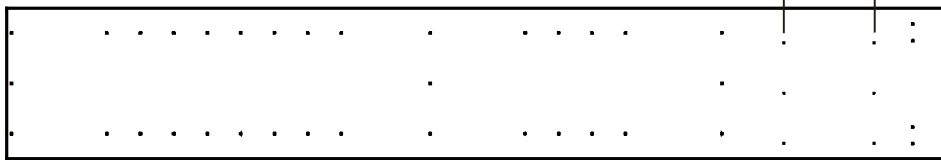

5 Left side panel (180 x 28.6cm)

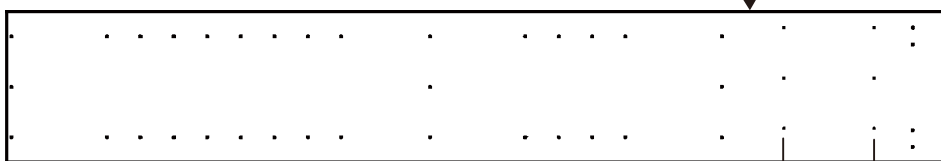

6 Right side panel (180 x 28.6cm)



7 Drawer front panel x 2 (74.4 x 16.8cm)

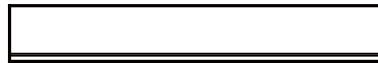

8 Drawer back panel x 2 (71.7 x 10.6cm)

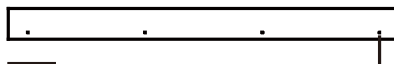

9 Front panel (74.9 x 5.9cm)

Pilot holes for guidance only

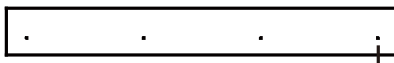

10 Bottom panel (74.9 x 8.9cm)

Pilot holes for guidance only

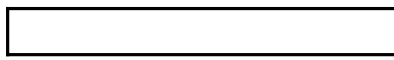

11 Back support (74.9 x 8.9cm)

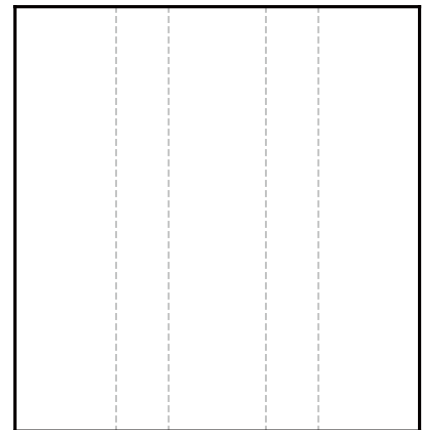

12 Top back panel (76.7 x 79.8cm)

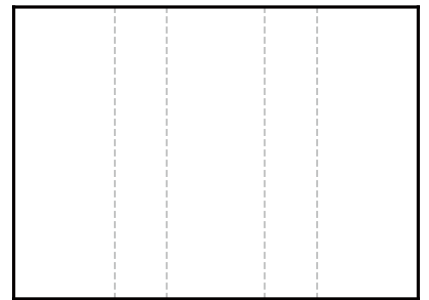

13 Middle back panel (76.7 x 56.8cm)

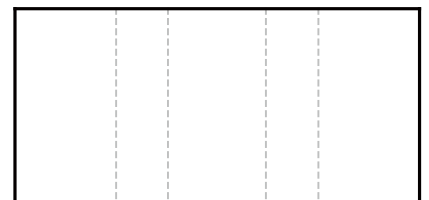

14 Bottom back panel (76.7 x 37cm)

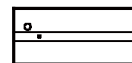

15 Drawer right side panel x 2 (24 x 10.6cm)

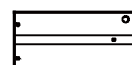

16 Drawer left side panel x 2 (24 x 10.6cm)

Pilot holes for guidance only

Finished front edge













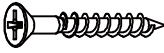

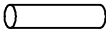
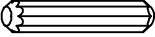
Pilot holes for guidance only



Components - Fittings

Please check you have all the fittings listed below

Note: The quantities below are the correct amount to complete the assembly. in some cases more fittings may be supplied than are required.

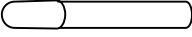
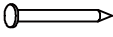
A  Plastic support x 4	B  14mm Screw x 9	C  30mm Screw x 12
D  50mm Screw x 12	E  Support cover x 12	F  Shelf support x 12
G  30mm Dowel x 18	H  12mm Locking nut x 4	I  34mm Locking pin x 4
J  Runner x 4	K  (This screw is included in the bag of runner) 12mm Screw x 12	L  12mm Screw x 4
M  Handle x 4	N  Screw cover x 12	O  (This screw is included in the bag of wall strap) x 1 Wall strap x 1  x 1
P  Wall plug x 1	Q  Glue x 1	R  Nail x 54

Tools required



Phillips screwdriver
(medium & large)



7mm Suitable drill bit
(for use with wall plug)

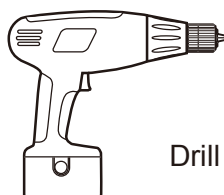

Drill



Small
hammer



Ruler/tape
measure



Eye protection
(when using a
hammer or glue)

Ruler - Use this ruler to help correctly identify the screws

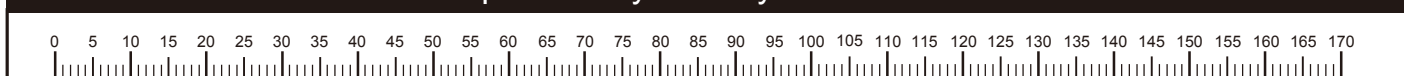

The screws length is measured from the head to the point (30mm screw shown).

Assembly Instructions

Step 1

Attaching runners

a: Position the Runners **J** in from front edge of the Right side panel **6**.

Slide top of the Runners **J** back.

Use Screws **K** to fix the Runners **J** on the Right side panel **6**.

Note: The front part of the Runner should be approximately 1.7 cm from the front edge of the panel.

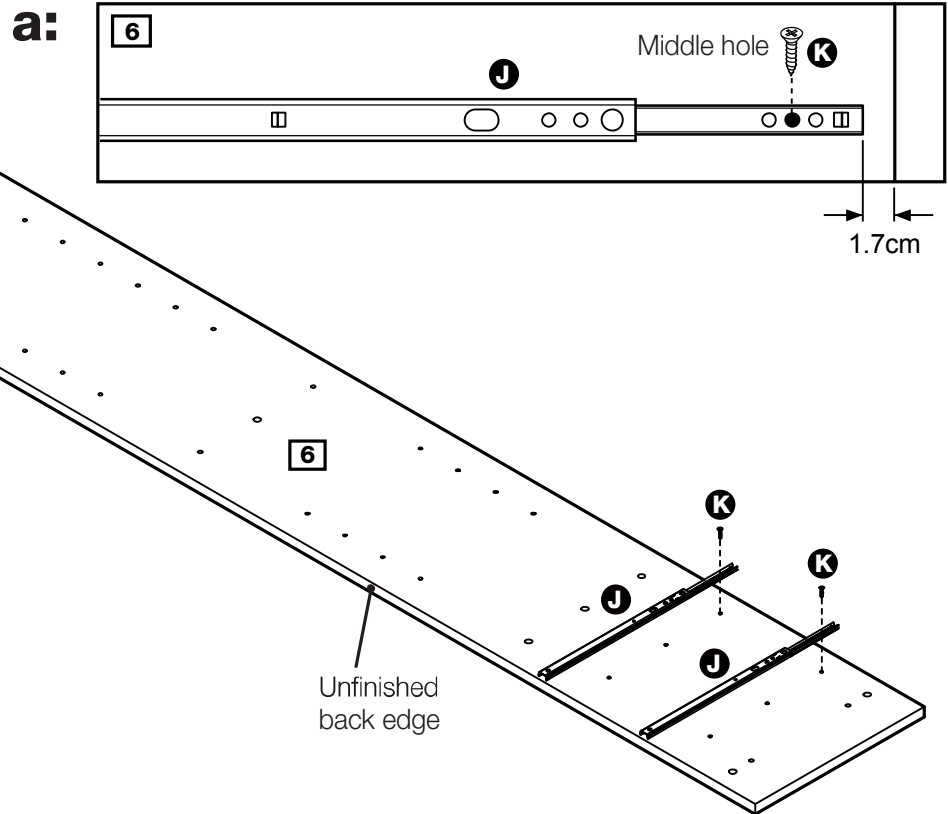

b: Slide top of the Runners **J** forward.

Use Screws **K** to fix the Runners **J** on the Right side panel **6**.

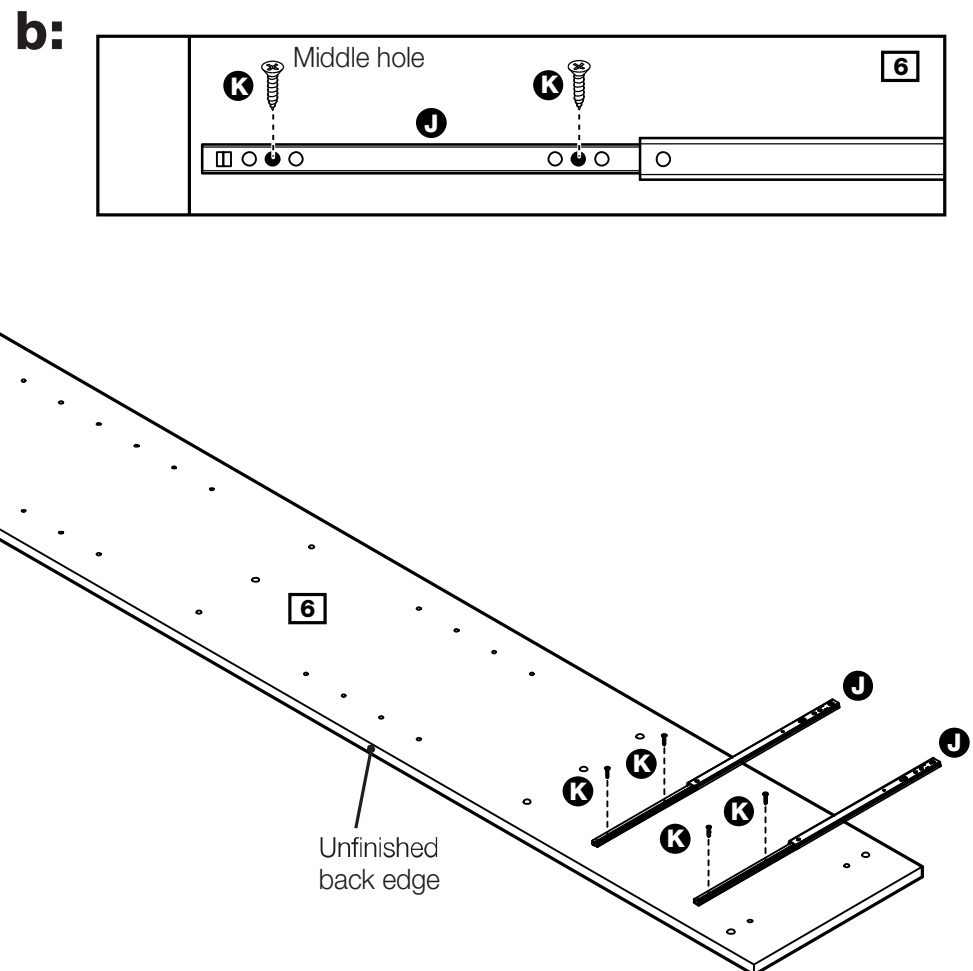

Continued on next page.

Assembly Instructions

Step 1- continued

Attaching runners

c: Position the Runners **J** in from front edge of the Left side panel **5**.

Slide top of the runners back.

Use Screws **K** to fix the Runners **J** on the Left side panel **5**.

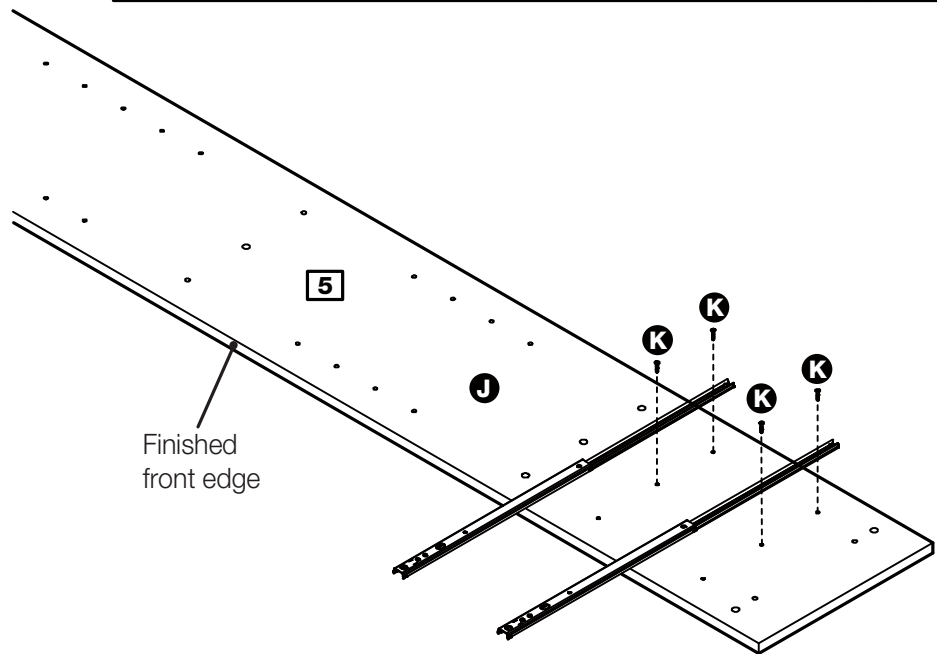
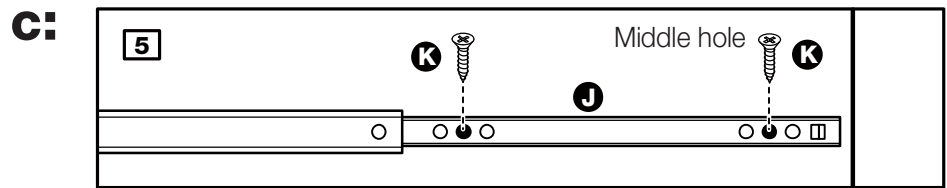

d: Slide top of the Runners **J** forward.

Use Screws **K** to fix the Runners **J** on the Left side panel **5**.

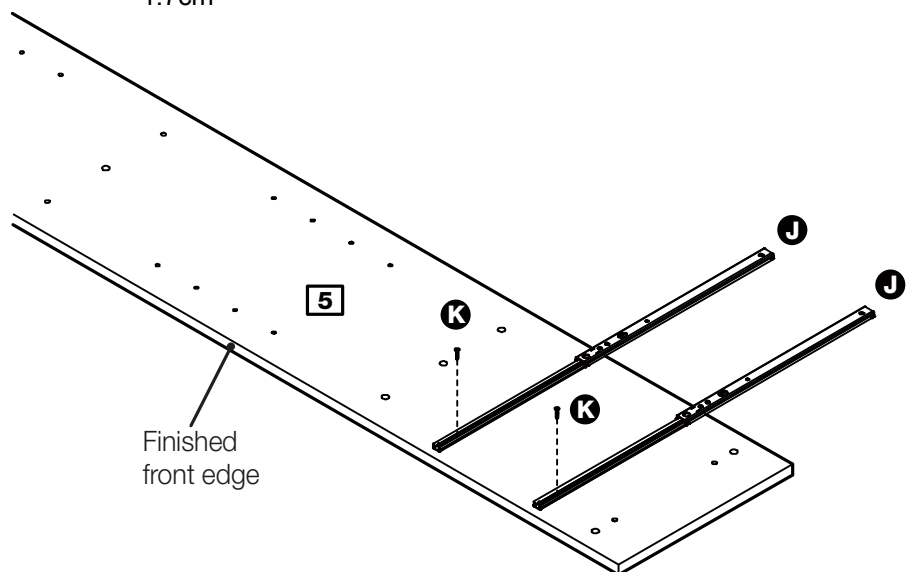
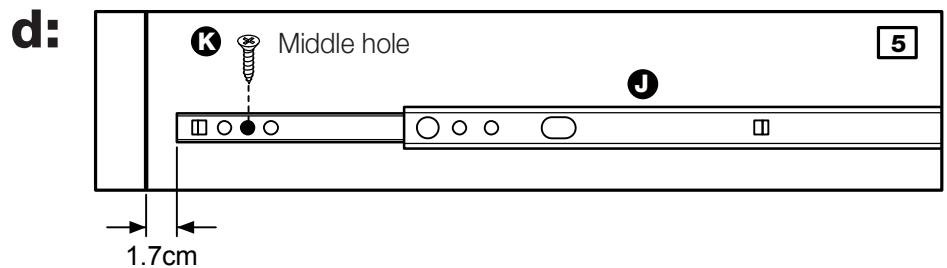

Assembly Instructions

Step 2

Attaching bottom panel

a: Use Plastic Supports **A** and Screws **B** to fix the Front panel **9** onto the Bottom panel **10**.

a:

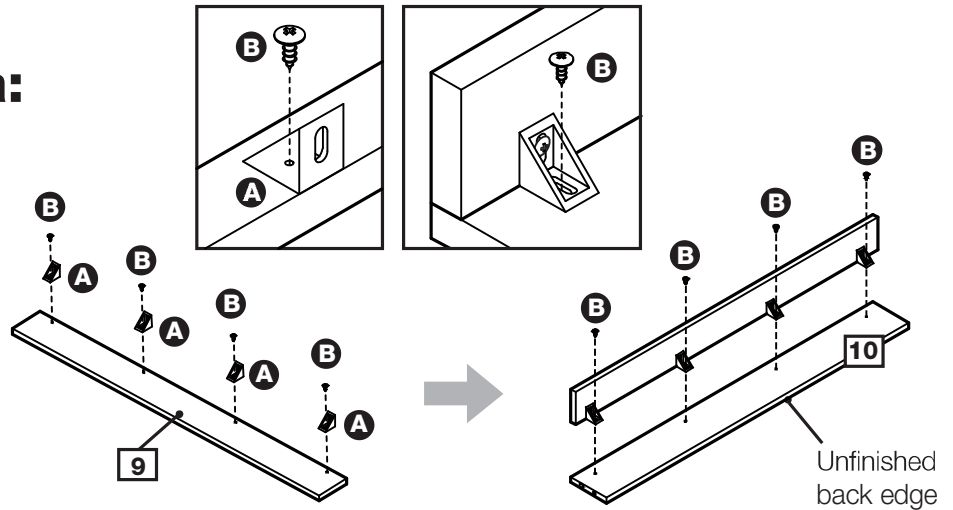

b: Insert Dowels **G** into the Bottom panel **10**.

b:

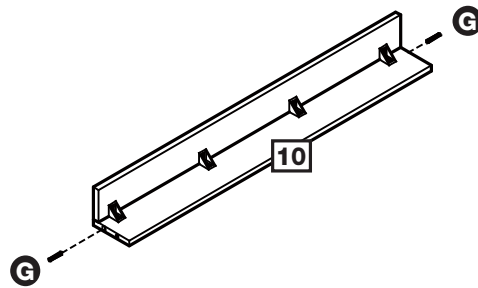

Step 3

Attaching side panels

a: Insert Dowels **G** into the Back support **11**.

a:

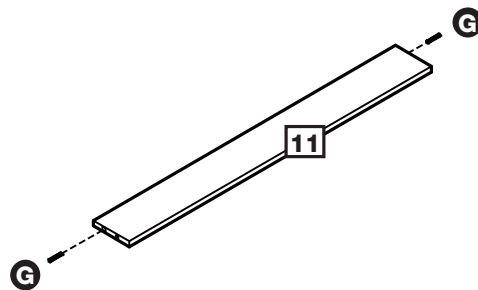

b: Insert Dowels **G** into the Fixed panels **1**.

b:

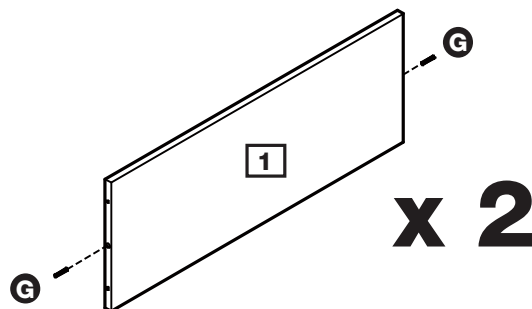

c: Insert Dowels **G** into the Middle panel **2**.

c:

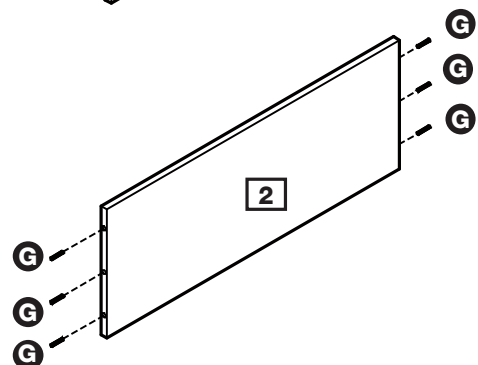

Continued on next page.

Assembly Instructions

Step 3 - continued



Caution: Always check the assembly method is correct before applying glue.

d: Place a small amount of Glue **Q** onto the joint's surfaces.

Use Screws **D** to fix the Left side panel **5** and Right side panel **6** onto the Fixed panels **1** and Middle panel **2**, Bottom panel **10**, Back support **11**.

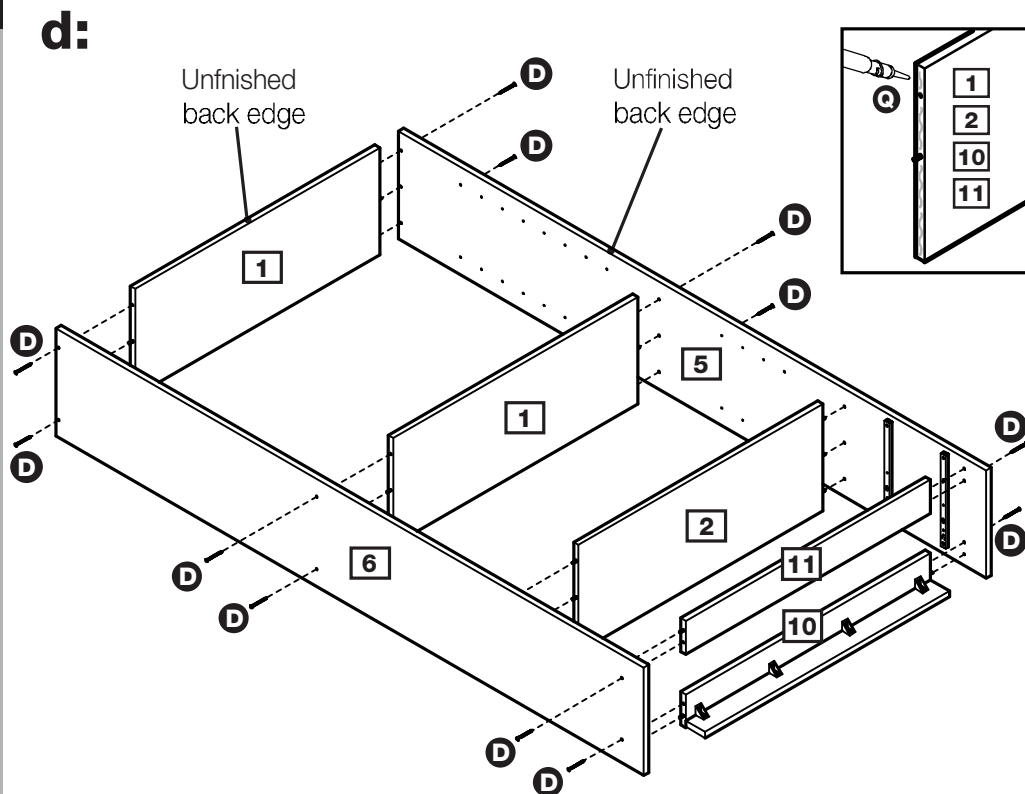

Step 4

Fixing back panels

Attach Top back panel **12**, Middle back panel **13** and Bottom back panel **14** onto the unit using Nails **R**.



Important: The unit **MUST** be 'square' when back is attached.

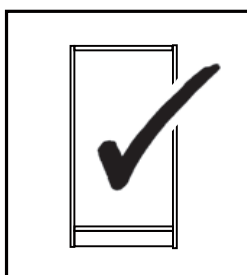
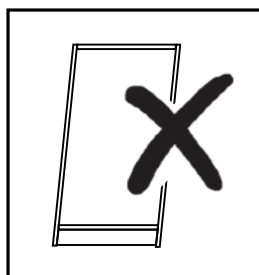
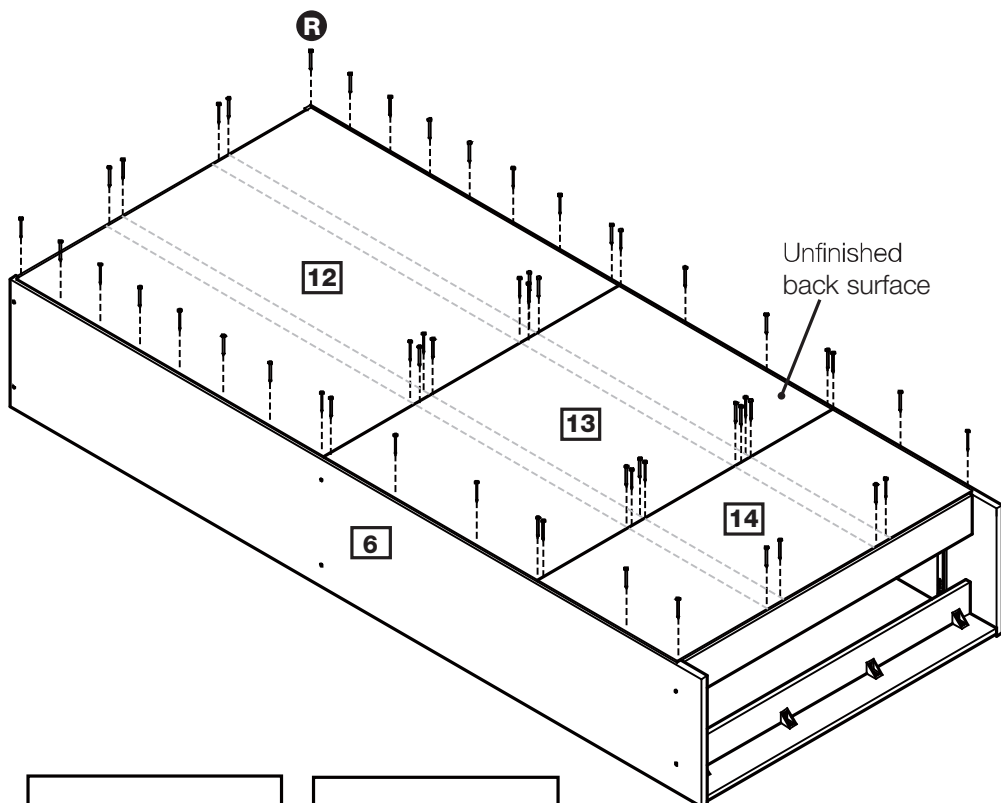

Assembly Instructions

Step 5

Attaching shelf panels

With help, carefully stand bookcase upright.



Warning:

The bookcase is heavy.
Lift with care.

a: Slide Support covers **E** onto Shelf supports **F**.

Insert Shelf supports **F** (Support covers **E** are included) into the unit. Ensure they are well fitted before inserting the Shelves.

Note: Set the shelf supports to the desired height.

Use Screw covers **N** to cover the screw heads.

a:

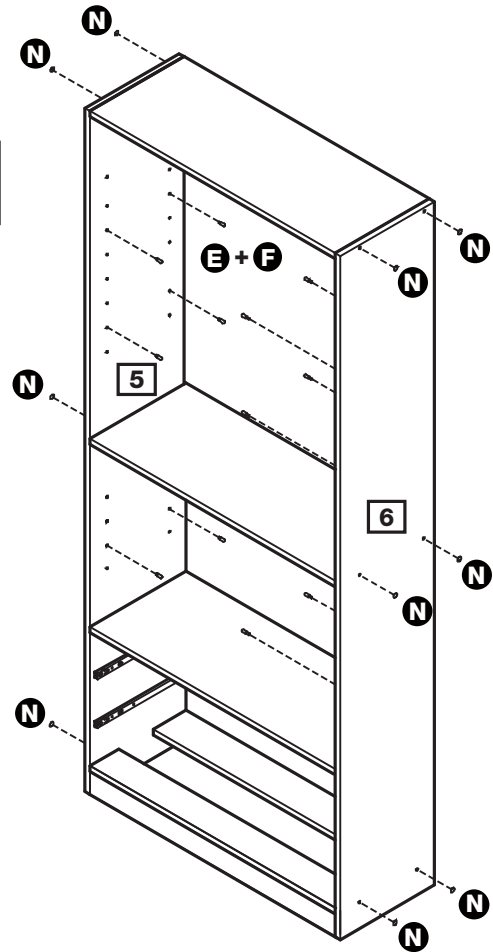
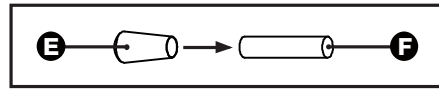

b: Slide the Shelves **3** into the unit.

b:

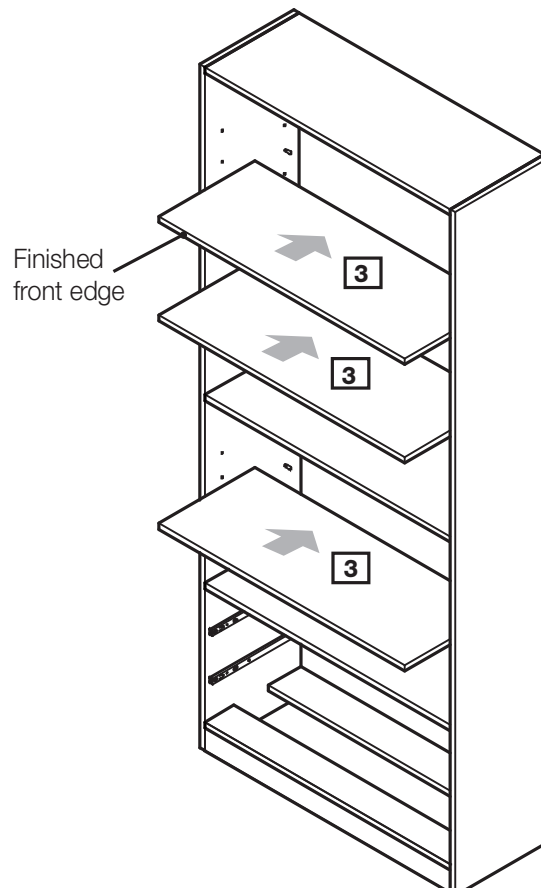

Assembly Instructions

Step 6

Drawer assembly

a: Fix Drawer right and left side panels **15** & **16** to Drawer back panel **8** using Screws **C**.

b: Place a small amount of Glue **Q** into the groove on the Drawer side panels and Drawer bottom panel. Carefully slide the Drawer bottom panel **4** into the unit.

c: Screw Locking pins **I** into the 2 holes shown on the back of the Drawer front panel **7**.

Note: Insert Locking pins as far as shown.

Do not over tighten.

Insert Dowels **G** into the Drawer front panel **7**.

d: Place a small drop of Glue **Q** into the groove.

Position the Drawer front **7** onto the drawer sides.

Ensure the panels fit together without any gaps.

e: Insert 2 Locking nuts **H** into the holes in the drawer sides (they will only insert one way).

Turn the Locking nuts **H** clockwise to lock the panels together.

Fix the Handles **M** onto **7** the Drawer front panel using Screws **C**.

Repeat with remaining drawer.

a:

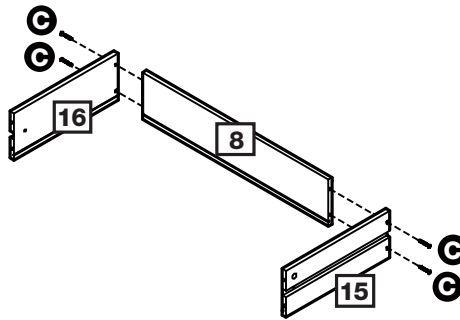

b:

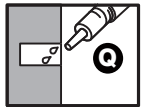
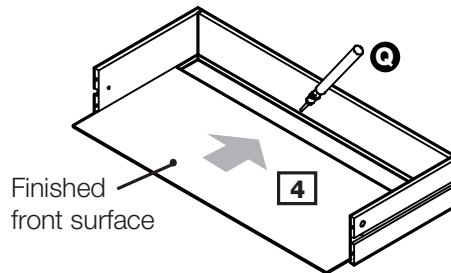

c:

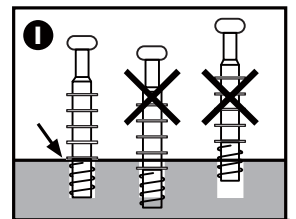
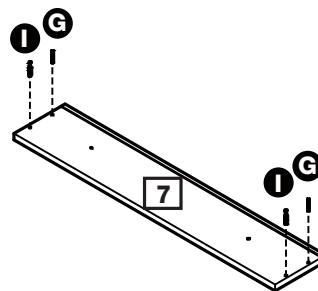

d:

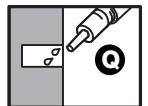
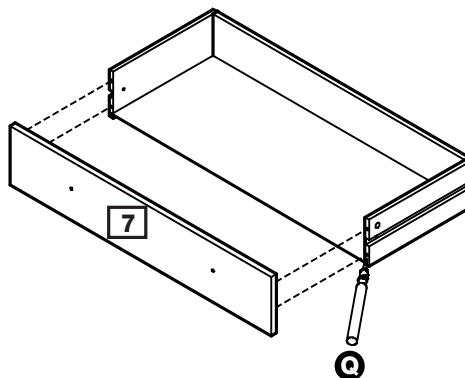

e:

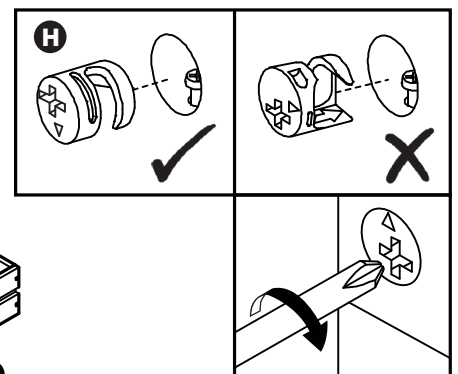
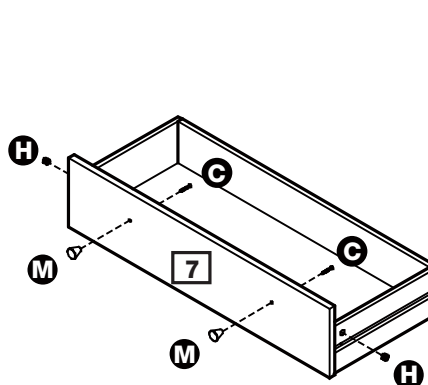

Assembly Instructions

Step 7

Inserting drawers

a: Slide the assembled drawers fully onto the runners so the runners butt up against the back of the drawer front.

b: From inside each drawer, fix through the holes in the sides into the runners using Screws **L**.

a:

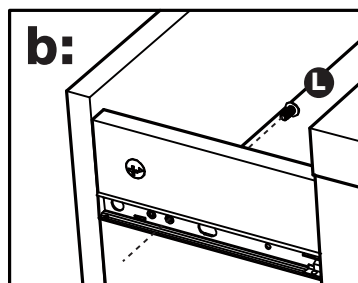
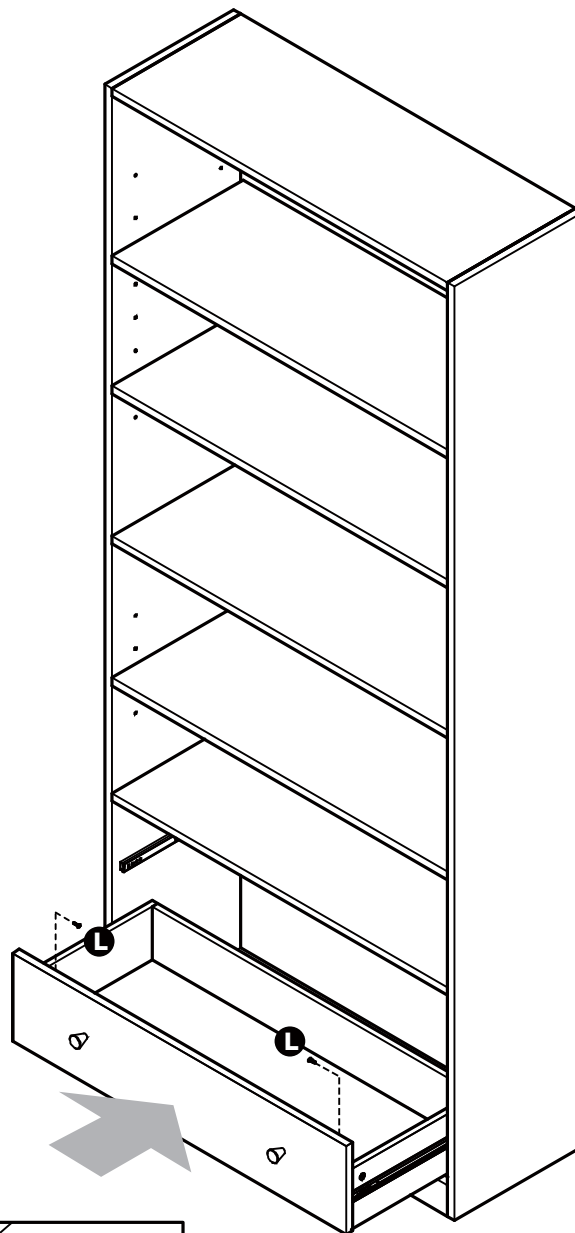

Assembly Instructions

Step 8

Fixing to wall

It is recommended that the bookcase is fixed to a wall.

Use Screw **B** to fix the Wall strap **O** onto the top panel.

With help, move bookcase into position.



Warning:

The bookcase is heavy.

Lift with care.

Mark fixing hole on wall and remove bookcase .

Drill a hole and insert Wall plug **P** .



Warning:

Before drilling, check wall for hidden pipes and cables.

Reposition bookcase and fix wall strap using Screw **O** .

Note: Before use allow the glue to dry for 24 hours and make sure the unit is secure.

Assembly is complete.

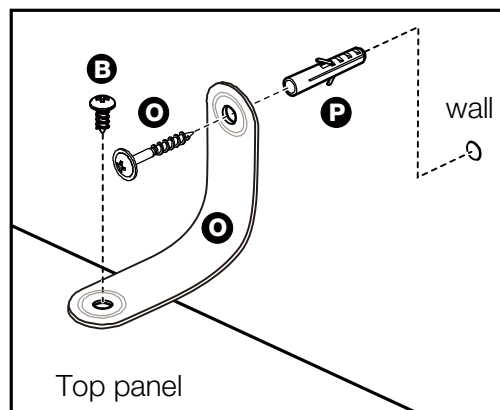

Note: Wall plugs supplied are for solid wall only.
The correct type of fixing must be used for your wall, seek professional advice if in doubt

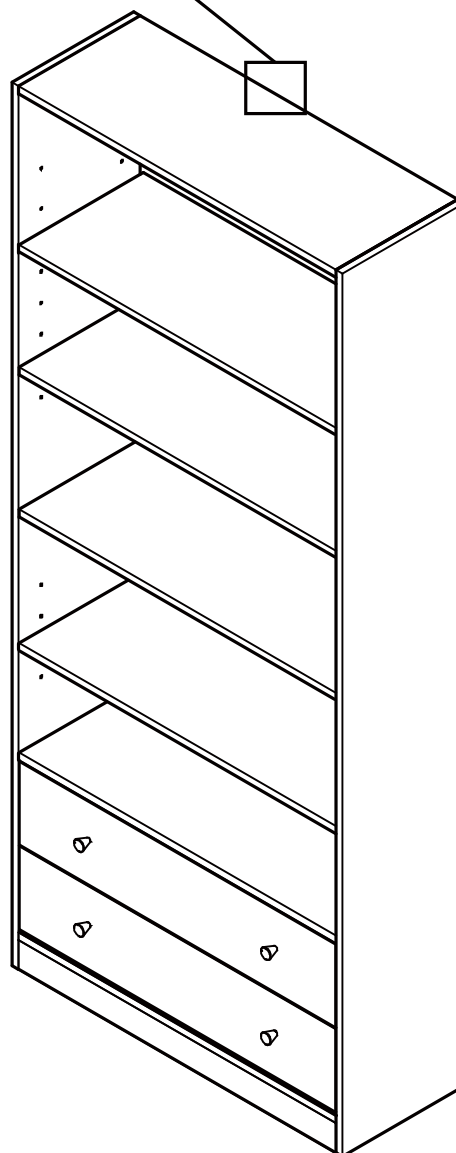
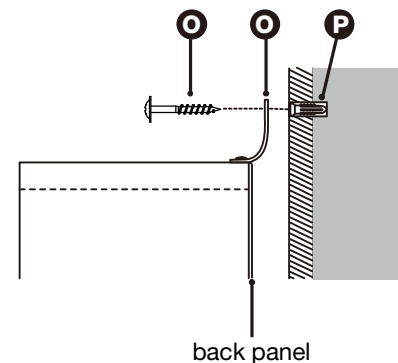

If you need help or have damaged or missing parts, call the **Customer Helpline:**
Argos = 0345 6400800

A Guide to - Wall Mounting & Fixings

Important note:

If plastic wall plugs are supplied with your product:



- these are only suitable for use in masonry walls.

If you are in any doubt about the correct wall plugs for your wall, seek professional advice.

Failure of the product due to using incorrect fixings is the responsibility of the installer.



Important: When drilling into walls always check that there are no hidden wires or pipes etc.

Make sure that the screws and wall plugs being used are suitable for supporting your unit. Consult a qualified tradesperson if you are unsure.

Hints:

- 1: General rule:**  Always use a larger screw and wall plug if you are not sure.
- 2:** Ensure you use the recommended drill bit to match the wall plug and hole size.
- 3:** Ensure you drill the hole horizontally, do not force the drill or enlarge the hole.
- 4:** Take extra care when drilling high walls, ceilings and ceramic tiles. Ensure wall plugs are inserted beyond the thickness of the ceramic tiles to avoid the tiles splitting or cracking.
- 5:** Ensure wall plugs are well fitted and are a tight fit in the drilled hole.

Types of walls

You can use one of the following types of wall plug if your walls are made of brick, breeze block, concrete, stone or wood.

No.1 "General Purpose" wall plug

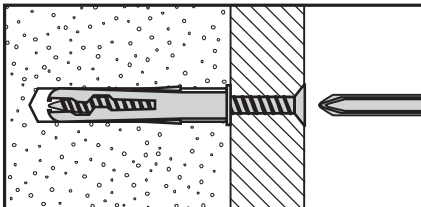

Generally aerated blocks should not be used to support heavy loads, use a specialist fitting in this case. For light loads, general purpose wall plugs can be used.

No.2 "Plasterboard" wall plug

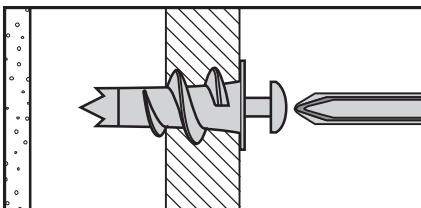

For use when attaching light loads on to plasterboard partitions.

No.3 "Cavity Fixing" wall plug

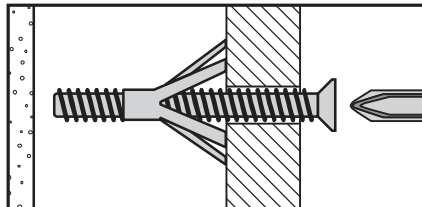

For use with plasterboard partitions or hollow wooden doors.

No.4 "Cavity Fixing-Heavy Duty" wall plug

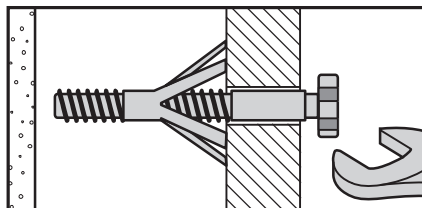

For use when fitting or supporting heavy loads such as shelving, wall cabinets and coat racks.

No.5 "Hammer Fixing" wall plug

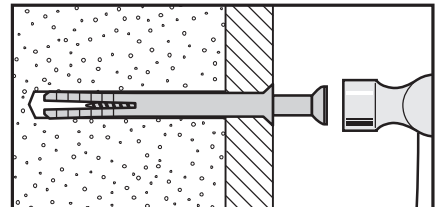

For use with walls stuck with plasterboard. The hammer fixing allows it to be fixed to the wall rather than the plasterboard. Always check the fixing is secure to the retaining wall.

No.6 "Shield Anchor" wall plug Heavy loads

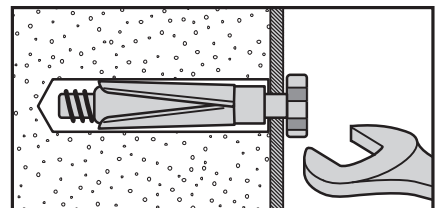

For use with heavier loads such as TV & HiFi speakers and satellite dishes etc.



Care & Maintenance

Safety: Always check the fitting and location to ensure your safety in and around the home.

Fitting: From time to time check the fitting to ensure the wall plugs or screws do not become loose.

2 Drawers/Tall/Wide/Extra Deep Bookcase

Assembly Instructions - Please keep for future reference

609/2050

609/2548

609/2555

609/3578

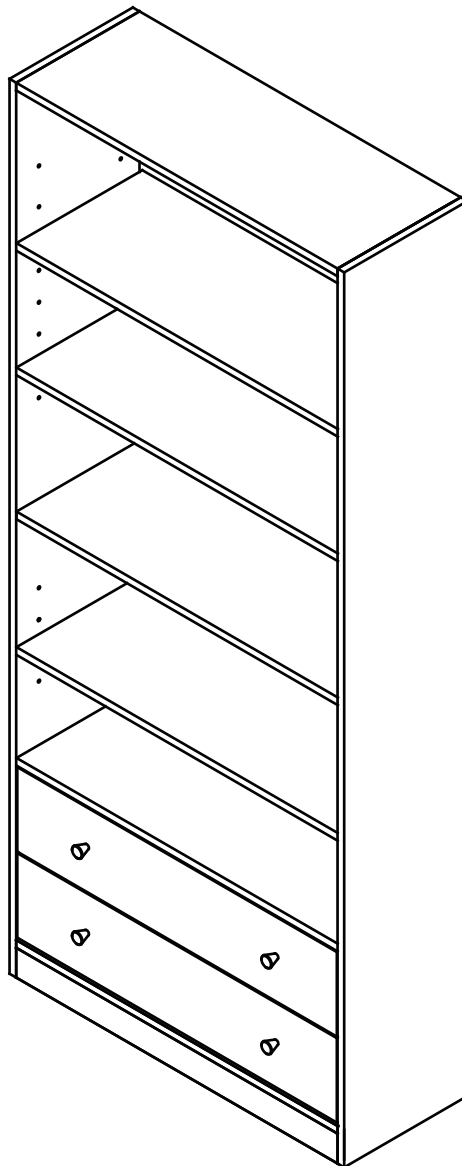

Dimensions

Width - 78cm

Depth - 29.1cm

Height - 180.1cm

Important - Please read these instructions fully before starting assembly

If you need help or have damaged or missing parts, call the **Customer Helpline: 08456 400800**



Safety and Care Advice

Important – Please read these instructions fully before starting assembly

- Check you have all the components and tools listed on pages 2 and 3.
- Remove all fittings from the plastic bags and separate them into their groups.
- Keep children and animals away from the work area, small parts could choke if swallowed.
- Make sure you have enough space to layout the parts before starting.

- Do not stand on the product, this could cause damage.
- Assemble the item as close to its final position (in the same room) as possible.
- Assemble on a soft level surface to avoid damaging the unit or your floor.
- Parts of the assembly will be easier with 2 people.



• We do not recommend the use of power drill/drivers **for inserting screws**, as this could damage the unit. Only use hand screwdrivers.

- Dispose of all packaging carefully and responsibly.

• **Note:** Only apply the glue once you are sure of the assembly.

Glue safety - Take care when using glue, please follow the advice below

Skin contact: Remove contamination by washing with soap and water. This procedure should also be followed prior to eating and drinking.

Eye contact: Rinse immediately with clean water for 15 minutes and seek medical advice.

If swallowed: Seek medical advice immediately.

Care and maintenance

• Only clean using a damp cloth and mild detergent, do not use bleach or abrasive cleaners.

• From time to time check that there are no loose screws on this unit.

• This product should not be discarded with household waste. Take to your local authority waste disposal centre.

Note: if required the next page can be cut out and used as reference throughout the assembly. Keep this page with these instructions for future reference.

Components - Panels

If you have damaged or missing components, call the **Customer Helpline: 08456 400800**

Please check you have all the panels listed below



1 Fixed Panel x 2 (74.9 x 28.4cm)



2 Middle Panel (74.9 x 28.4cm)



3 Shelf x 3 (74.9 x 28.4cm)



4 Drawer Bottom Panel x 2 (72.6 x 23.6cm)

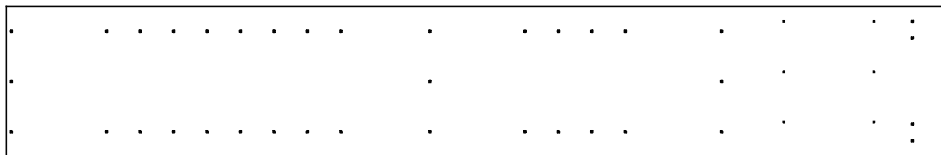

5 Right Side Panel (180 x 28.6cm)

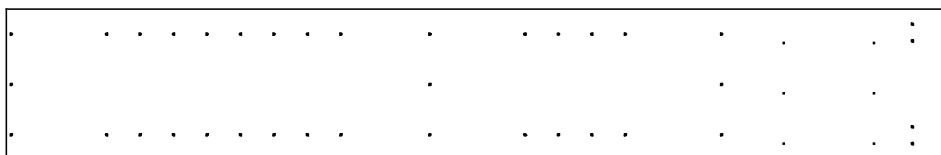

6 Left Side Panel (180 x 28.6cm)



7 Drawer Front Panel x 2 (74.4 x 17cm)



8 Drawer Back Panel x 2 (71.7 x 10.6cm)

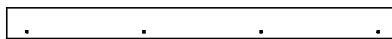

9 Front Panel (74.9 x 5.9cm)



10 Bottom Panel (74.9 x 8.9cm)



11 Back Support (74.9 x 8.9cm)

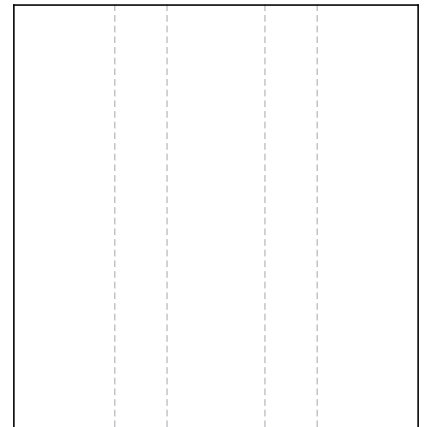

12 Top Back Panel (79.8 x 76.7cm)

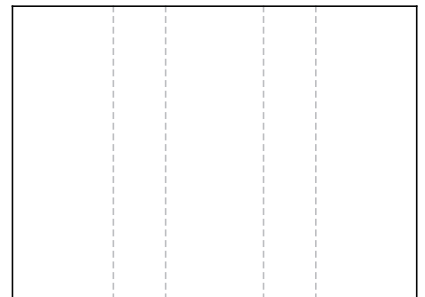

13 Middle Back Panel (56.8 x 76.7cm)

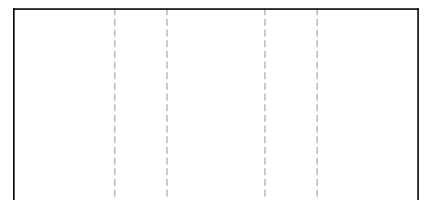

14 Bottom Back Panel (37 x 76.7cm)

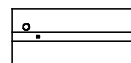

15 Drawer Right Side Panel x 2 (24 x 10.6cm)

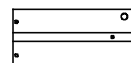













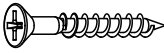

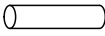
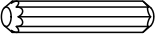
16 Drawer Left Side Panel x 2 (24 x 10.6cm)



Components - Fittings

Please check you have all the fittings listed below

Note: The quantities below are the correct amount to complete the assembly. in some cases more fittings may be supplied than are required.

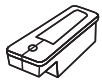
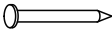
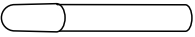
A  Plastic Support x 4	B  14mm Screw x 9	C  30mm Screw x 12
D  50mm Screw x 12	E  Support Cover x 12	F  Shelf Support x 12
G  Wooden Dowel x 18	H  12mm Locking Nut x 4	I  Locking Pin x 4
J  Runner x 4	K  (The Screws is included in the bag of Runner) 12mm Screw x 12	L  12mm Screw x 4
M  Handle x 4	N  Screw Cover x 12	O  (This screw is included in the bag of wall strap)  x 1 Wall Strap x 1
P  Wall Plug x 1	Q  Nail Guide x 1	R  Nail x 54
S  Glue x 1		

Tools required

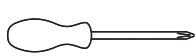

Phillips screwdriver
(medium & large)



Bradawl
(or sharp point)

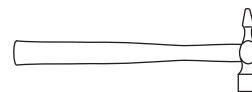

Small
hammer



Ruler/tape
measure

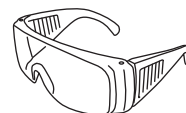

Eye protection
(when using a
hammer or glue)

Ruler - Use this ruler to help correctly identify the screws



Assembly Instructions

Step 1

Attaching runners

a: Position the Runners **J** in from front edge of the Right Side Panel **5**.

Slide top of the runners back.

Use Screws **K** to fix the Runners **J** on the Right Side Panel **5**.

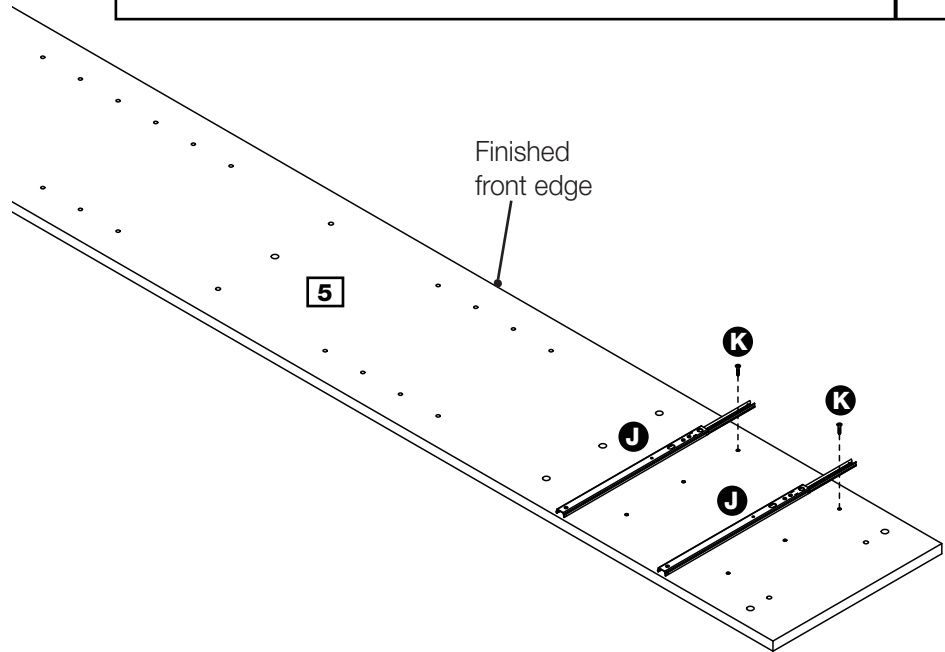
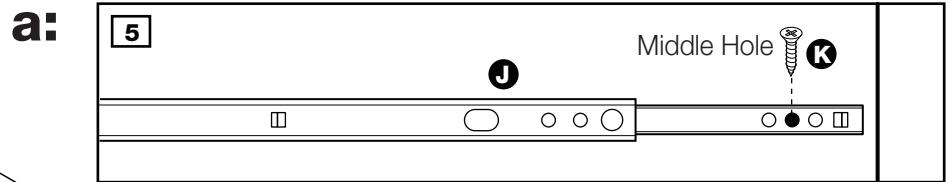

b: Slide top of the Runners **J** forward.

Use Screws **K** to fix the Runners **J** on the Right Side Panel **5**.

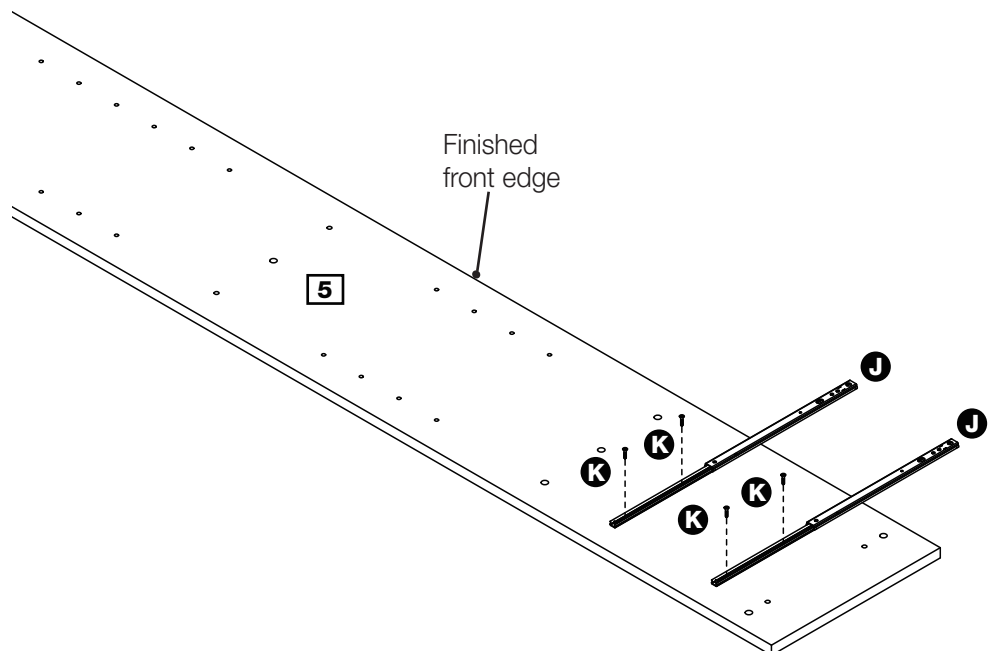
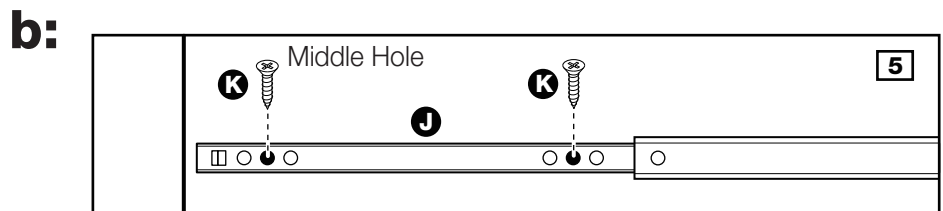

Repeat a and b on the Left Side Panel **6** with remaining Runner **J** and Screws **K**.

Assembly Instructions

Step 2

Attaching bottom panel

a: Use Plastic Supports **A** and Screws **B** to fix the Front Panel **9** onto the Bottom Panel **10**.

a:

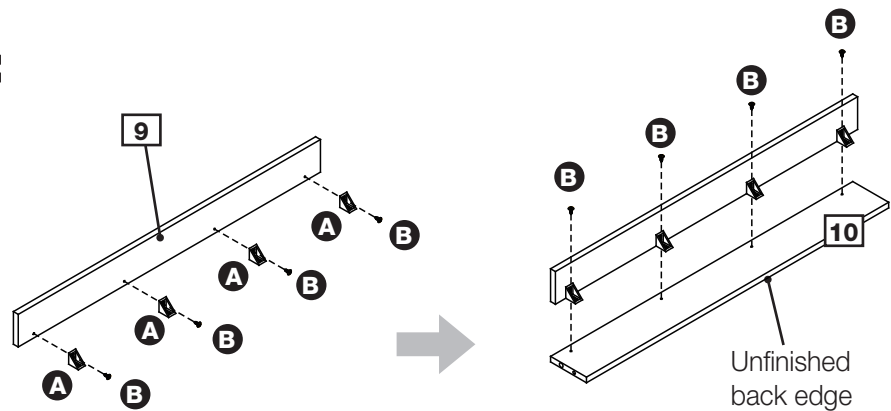

b: Place a small amount of Glue **S** into the dowel holes. Insert Wooden Dowels **G** into the Bottom Panel **10**.

b:

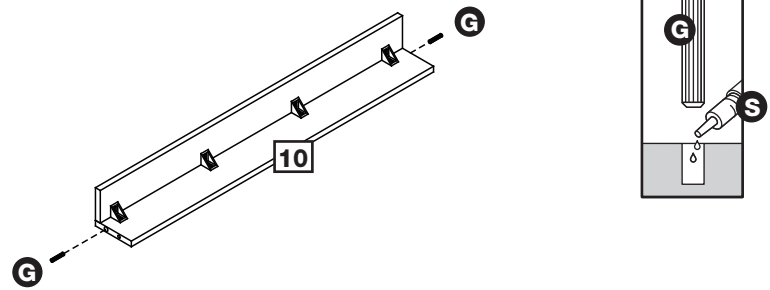

Step 3

Attaching side panels

a: Place a small amount of Glue **S** into the dowel holes. Insert Wooden Dowels **G** into the Back Support **11**.

a:

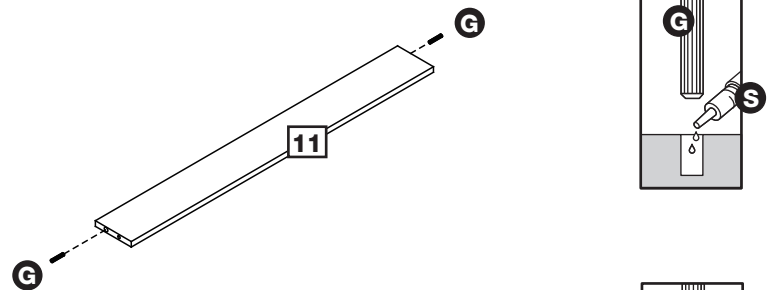

b: Place a small amount of Glue **S** into the dowel holes. Insert Wooden Dowels **G** into the Fixed Panels **1**.

b:

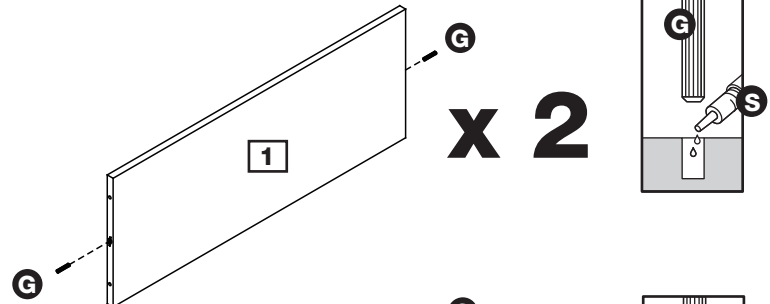

c: Place a small amount of Glue **S** into the dowel holes. Insert Wooden Dowels **G** into the Middle Panel **2**.

c:

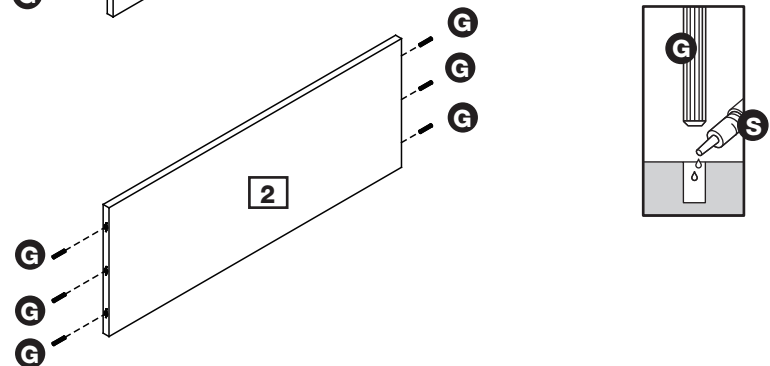

Assembly Instructions

Step 3 - continued



Caution: Always check the assembly method is correct before applying glue.

d: Place a small amount of Glue **S** onto the joint's surfaces and ends of fitted Wooden Dowels **G**.

Use Screws **D** to fix the Left Side Panel **6** and Right Side Panel **5** onto the Fixed Panels **1** and Middle Panel **2**, Bottom panel **10**, Back Support **11**.

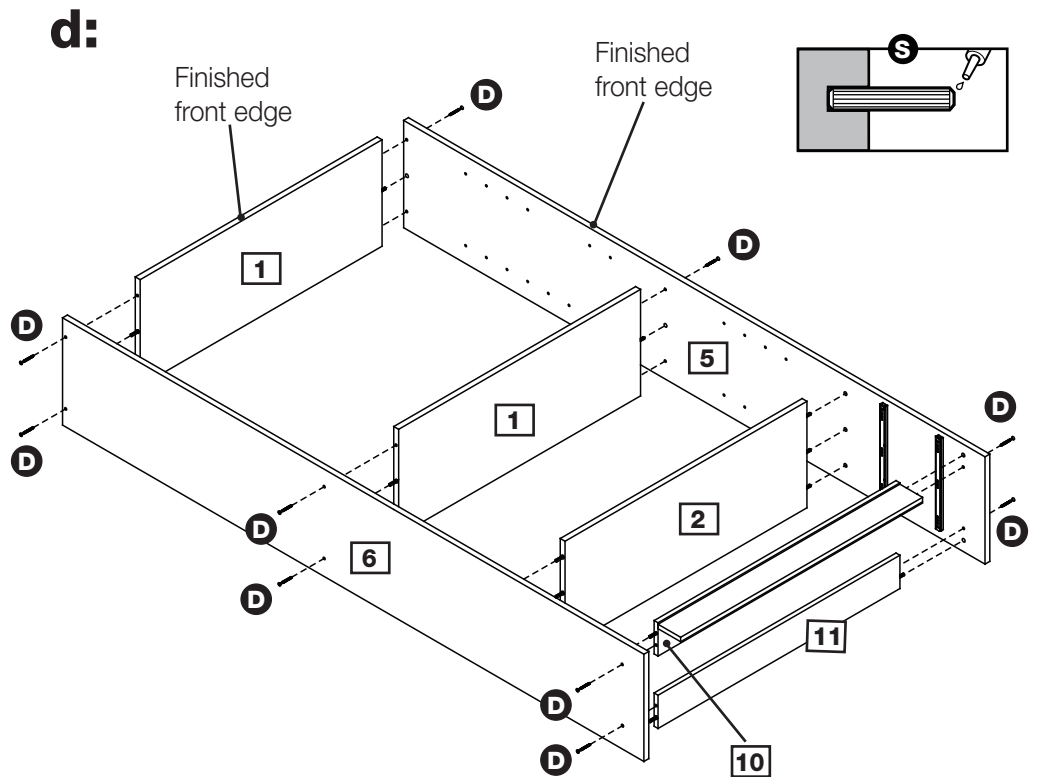

Step 4

Fixing back panel

a: Use Nails **R** to fix the Top Back Panel **12** and Middle Back Panel **13**, Bottom Back Panel **14** onto the unit.

Note: Use Nail Guide **Q** to keep a constant distance from the edge.



Important: The cabinet **MUST** be 'square' when the back is attached.

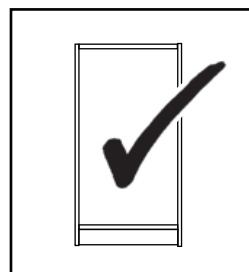
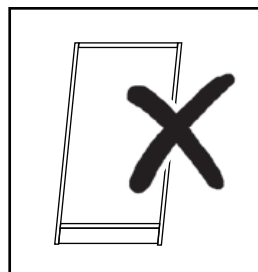
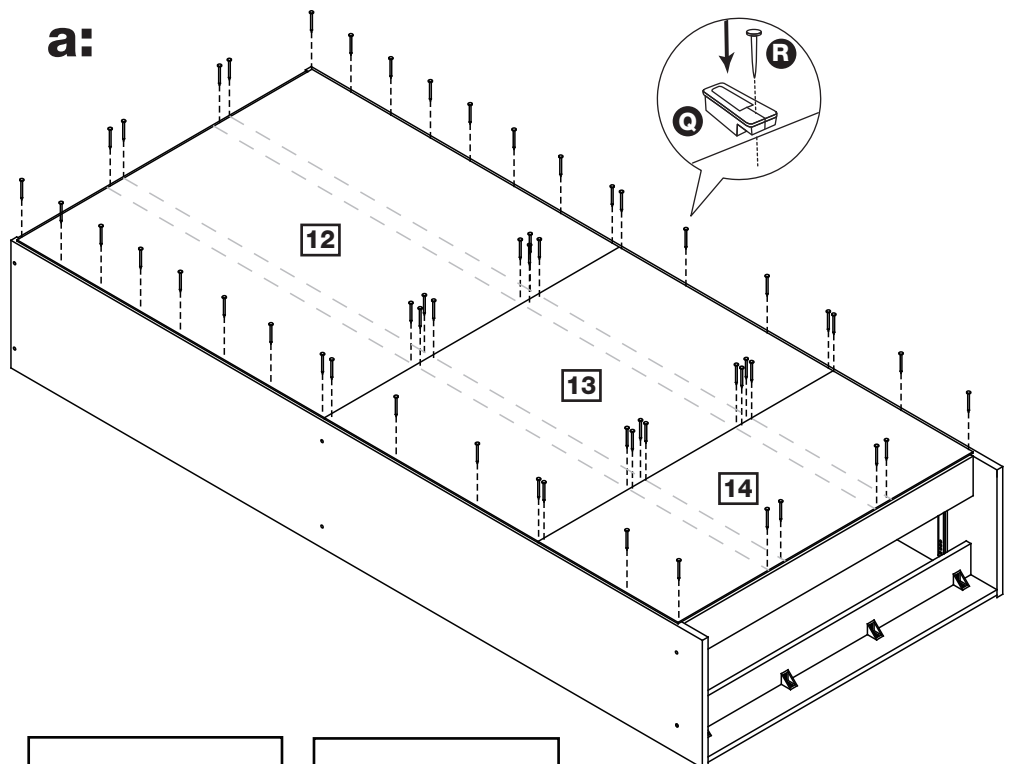

Assembly Instructions

Step 5

Attaching shelf panel

a: Slide Support Covers **E** onto Shelf Supports **F**.

Insert Shelf Supports **F** (Support Covers **E** are included) into the unit. Ensure they are well fitted before inserting the Shelves.

Note: Set the shelf supports to the desired height.

Use Screw Covers **N** to cover the Screw Heads.

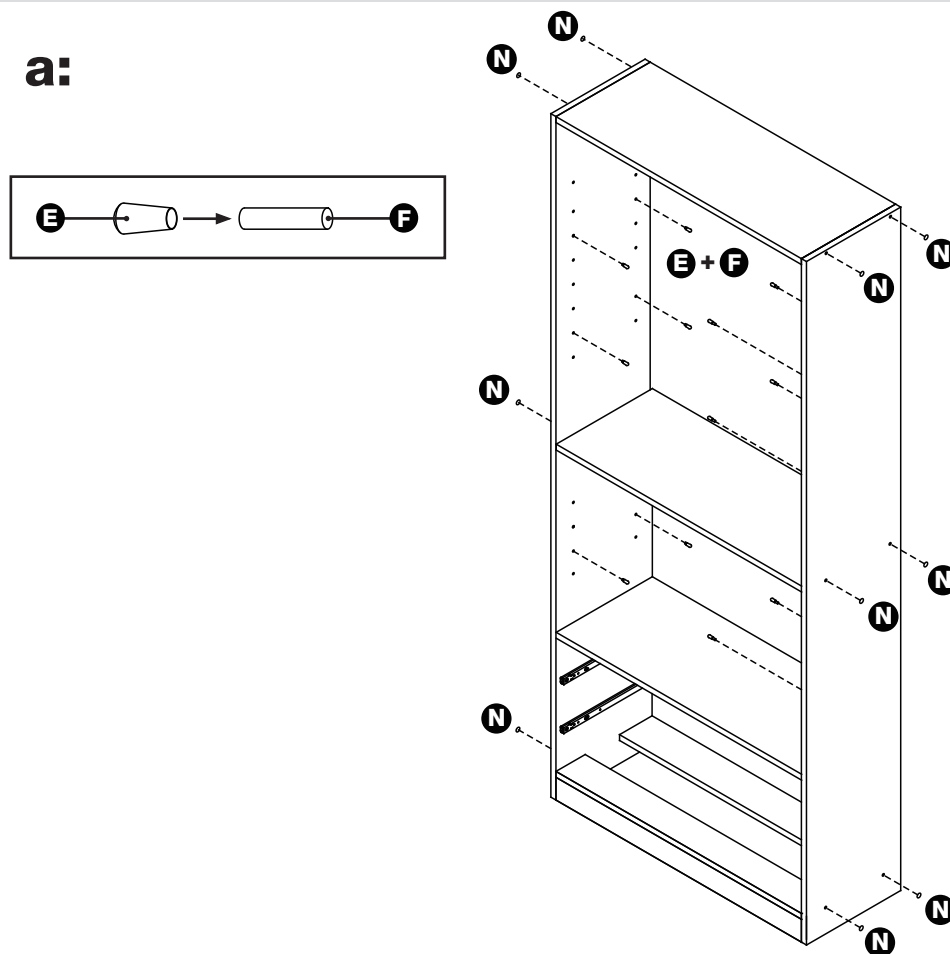

b: Slide the Shelves **3** into the unit.

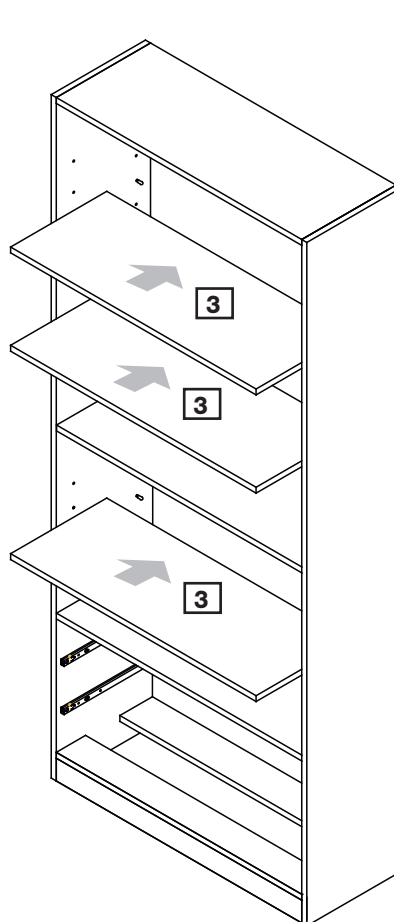

Assembly Instructions

Step 6

Drawer assembly

a: Fix Drawer Right and Left Side Panels **15** & **16** to Drawer Back Panel **8** using Screws **G**.

b: Place a small amount of Glue **S** into the groove on the Drawer Side Panels and Drawer Bottom Panel. Carefully slide the Drawer Bottom **4** into the unit.

c: Screw Locking Pins **I** into the 2 holes shown on the back of the Drawer Front Panel **7**.

Note: Insert Locking Pins as far as shown.

Do not over tighten.

Place a small drop of Glue **S** into the 2 holes shown and insert Wooden Dowels **G**.

d: Place a small drop of Glue **S** onto the ends of the Wooden Dowels **G** and into the groove.

Position the Drawer Front **7** onto the drawer sides.

Ensure the panels fit together without any gaps.

e: Insert 2 Locking Nuts **H** into the holes in the drawer sides (they will only insert one way).

Turn the Locking Nuts **H** clockwise to lock the panels together.

Fix the Handles **M** onto the Drawer Front Panel using Screws **C**.

Repeat with remaining drawer.

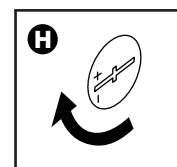
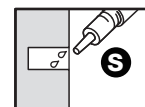
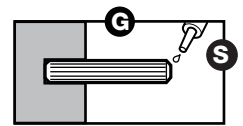
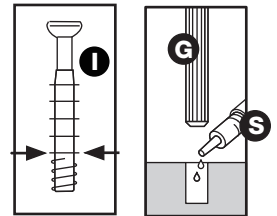
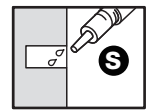
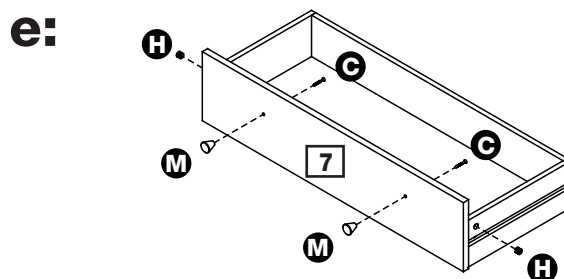
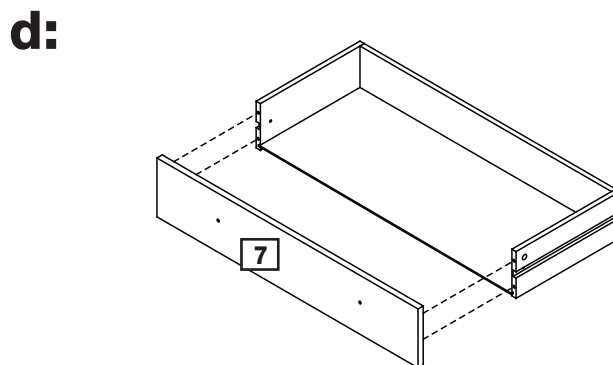
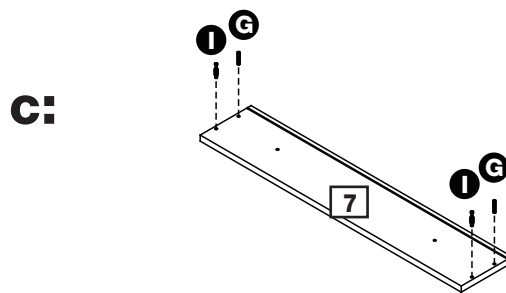
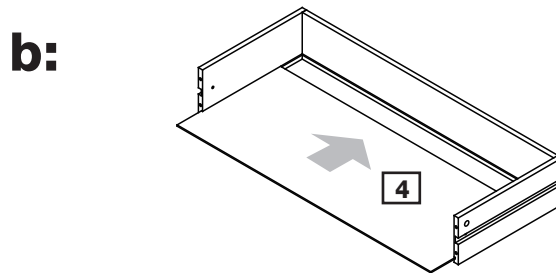
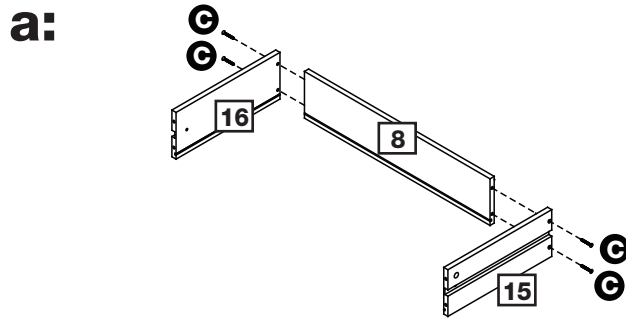

Assembly Instructions

Step 7

Inserting drawers

a: Slide the assembled drawers fully onto the runners so the runners butt up against the back of the drawer front.

b: From inside each drawer, fix through the holes in the sides into the runners using Screws **L**.

a:

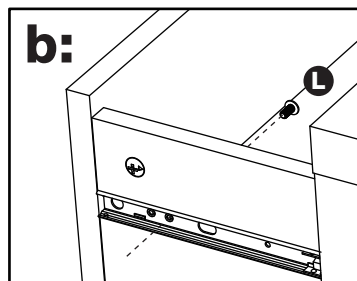
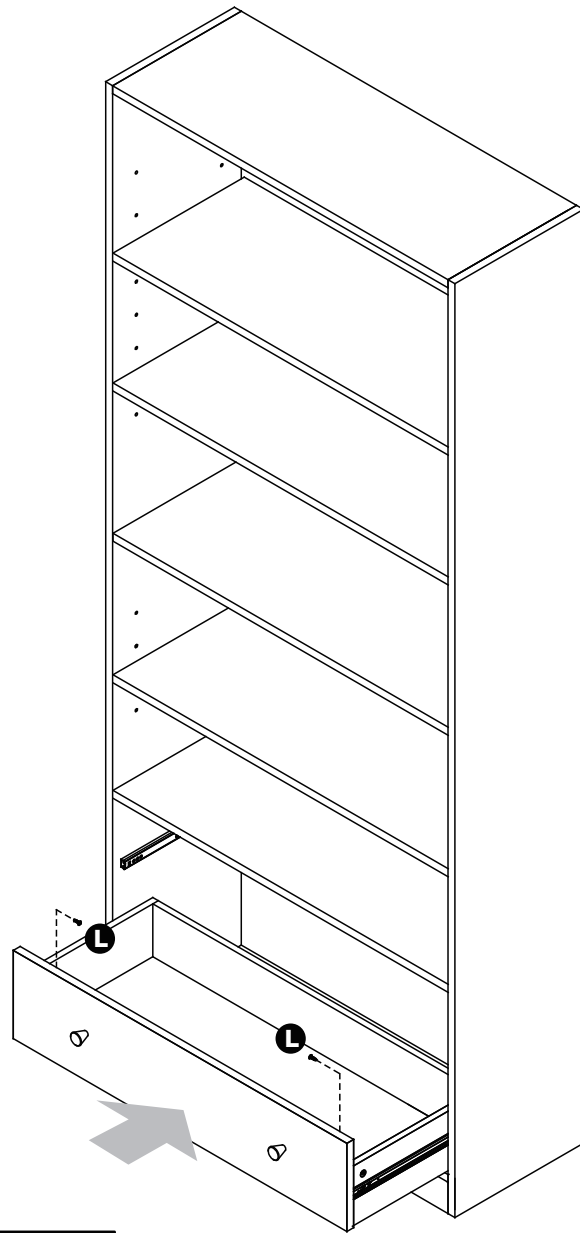

Assembly Instructions

Step 8

Fixing to wall

It is recommended that the bookcase is fixed to a wall.

Use Screw **B** to fix the Wall Strap **O** onto the back of the top panel.

With help, move bookcase into position.



Warning:

The bookcase is heavy.

Lift with care.

Mark fixing hole on wall and remove bookcase .

Drill a hole and insert Wall Plug **P**.



Warning:

Before drilling, check wall for hidden pipes and cables.

Reposition bookcase and fix wall strap using Screw **O**.

Note: Before use allow the Glue to dry for 24 hours and make sure the unit is secure.

Assembly is complete.

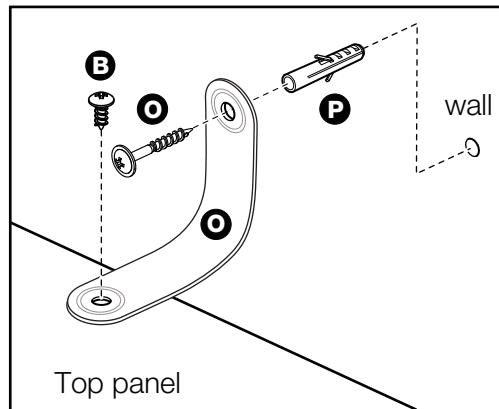

Note: Wall plugs supplied are for solid wall only.
The correct type of fixing must be used for your wall, seek professional advice if in doubt

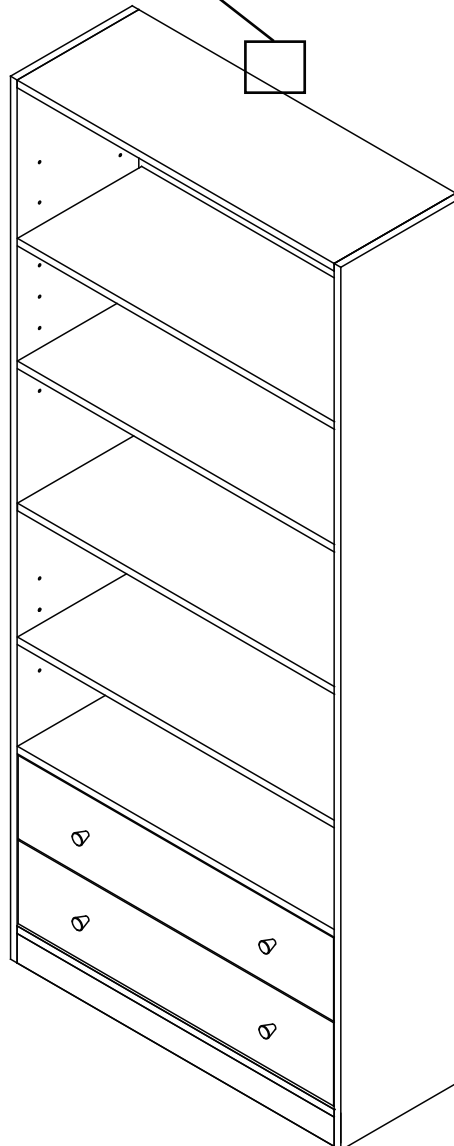
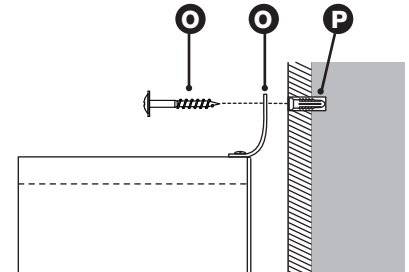

If you need help or have damaged or missing parts, call the **Customer Helpline: 08456 400800**

A Guide to - Wall Mounting & Fixings

Important note:

If plastic wall plugs are supplied with your product:



- these are only suitable for use in masonry walls.

If you are in any doubt about the correct wall plugs for your wall, seek professional advice.

Failure of the product due to using incorrect fixings is the responsibility of the installer.



Important: When drilling into walls always check that there are no hidden wires or pipes etc.

Make sure that the screws and wall plugs being used are suitable for supporting your unit. Consult a qualified tradesperson if you are unsure.

Hints:

- 1: General rule:**  Always use a larger screw and wall plug if you are not sure.
- 2:** Ensure you use the recommended drill bit to match the wall plug and hole size.
- 3:** Ensure you drill the hole horizontally, do not force the drill or enlarge the hole.
- 4:** Take extra care when drilling high walls, ceilings and ceramic tiles. Ensure wall plugs are inserted beyond the thickness of the ceramic tiles to avoid the tiles splitting or cracking.
- 5:** Ensure wall plugs are well fitted and are a tight fit in the drilled hole.

Types of walls

You can use one of the following types of wall plug if your walls are made of brick, breeze block, concrete, stone or wood.

No.1 "General Purpose" wall plug

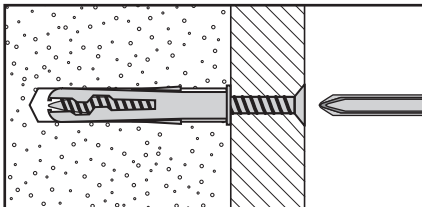

Generally aerated blocks should not be used to support heavy loads, use a specialist fitting in this case. For light loads, general purpose wall plugs can be used.

No.2 "Plasterboard" wall plug

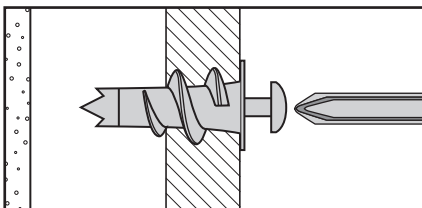

For use when attaching light loads on to plasterboard partitions.

No.3 "Cavity Fixing" wall plug

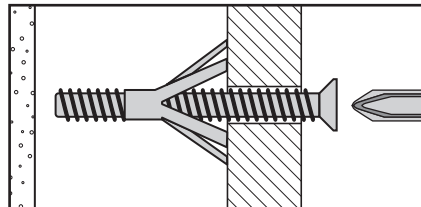

For use with plasterboard partitions or hollow wooden doors.

No.4 "Cavity Fixing-Heavy Duty" wall plug

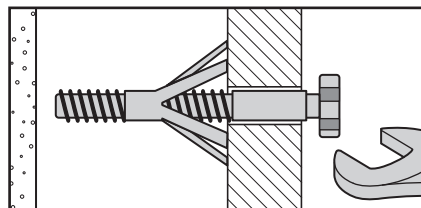

For use when fitting or supporting heavy loads such as shelving, wall cabinets and coat racks.

No.5 "Hammer Fixing" wall plug

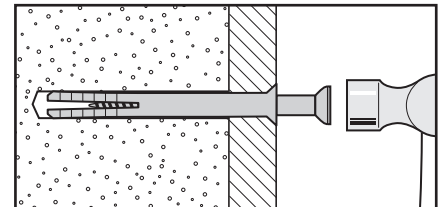

For use with walls stuck with plasterboard. The hammer fixing allows it to be fixed to the wall rather than the plasterboard. Always check the fixing is secure to the retaining wall.

No.6 "Shield Anchor" wall plug Heavy loads

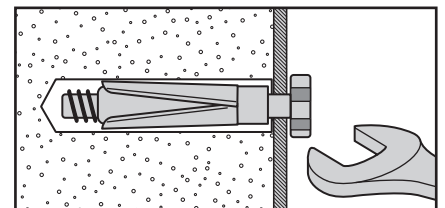

For use with heavier loads such as TV & HiFi speakers and satellite dishes etc.



Care & Maintenance

Safety: Always check the fitting and location to ensure your safety in and around the home.

Fitting: From time to time check the fitting to ensure the wall plugs or screws do not become loose.