

DAILY REFERENCE GUIDE



THANK YOU FOR PURCHASING AN HOTPOINT PRODUCT

To receive more comprehensive help and support, please register your product at www.hotpoint.eu/register



You can download the Safety Instructions and the Use and Care Guide by visiting our website docs.hotpoint.eu and following the instructions on the back of this booklet.



Before using the appliance carefully read the Health and Safety guide.

PRODUCT DESCRIPTION

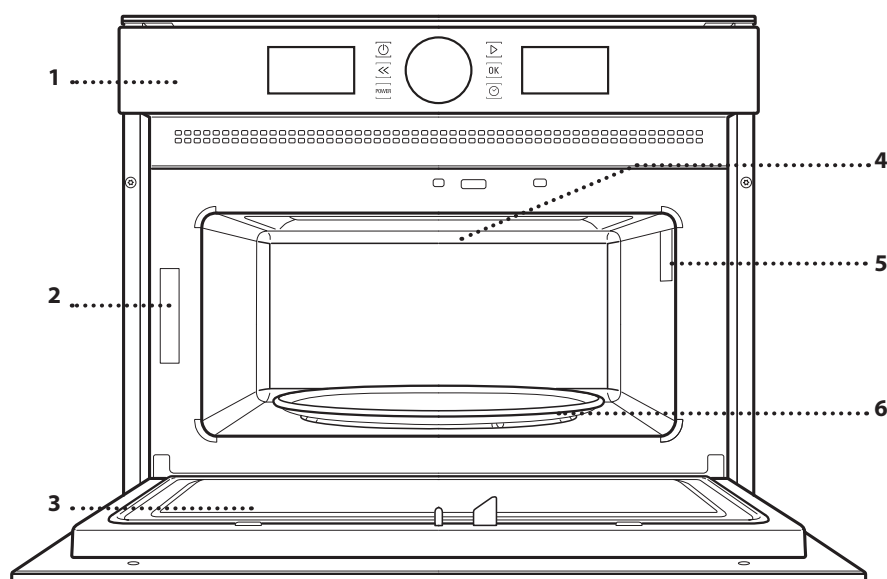

1. Control panel
2. Identification plate (do not remove)
3. Door
4. Upper heating element/grill
5. Light
6. Turntable

CONTROL PANEL

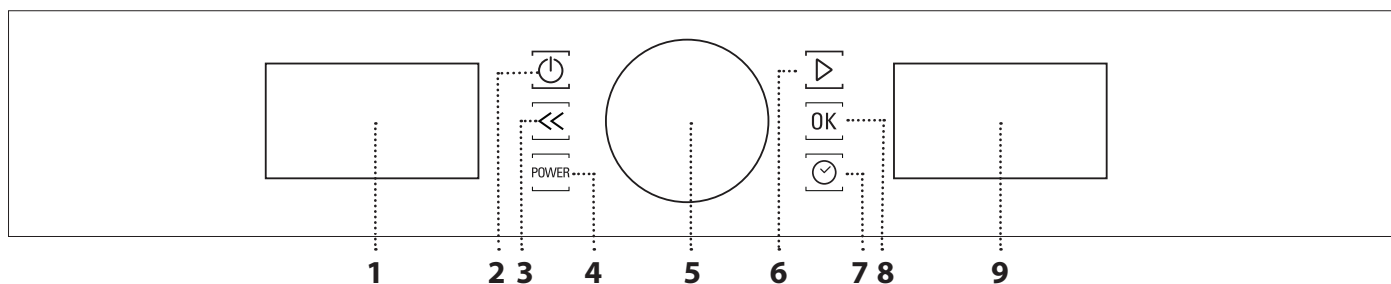

1. LEFT-HAND DISPLAY

2. ON/OFF

For switching the oven on and off and for stopping an active function at any time.

3. BACK

For returning to the previous menu.

4. POWER

For setting the power of the microwave.

5. KNOB

For navigating between the functions, as well as changing the time and cooking time parameters.

6. START

For starting functions and confirming settings.

7. TIME

For setting the time as well as setting or adjusting the cooking time.

8. CONFIRM

For confirming an item you have selected or the settings for a function.

9. RIGHT-HAND DISPLAY

TURNTABLE

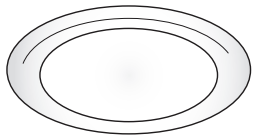

Placed on its support, the glass turntable can be used with all cooking methods. The turntable must always be used as a base for other containers or accessories, with the exception of the rectangular baking tray.

TURNTABLE SUPPORT

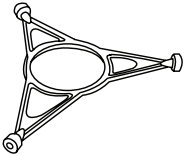

Only use the support for the glass turntable. Do not rest other accessories on the support.

CRISP PLATE

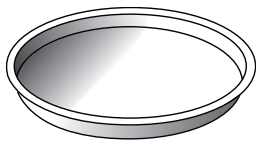

Only for use with the designated function . The Crisp plate must always be placed in the centre of the glass turntable and can be pre-heated when empty, using the special

function for this purpose only. Place the food directly on the Crisp plate.

HANDLE FOR THE CRISP PLATE

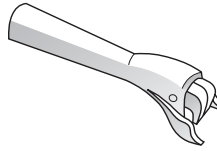

Useful for removing the hot Crisp plate from the oven.

WIRE RACK

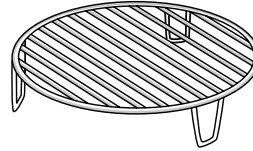

This allows you to place food closer to the grill, for perfectly browning your dish. Place the wire rack on the turntable, making sure that it does not come into contact with other

surfaces.

COVER (IF SUPPLIED)

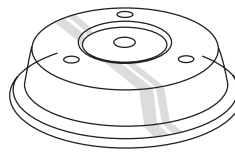

Useful for covering food while it is cooking or heating in the microwave. The cover reduces splashes, keeps foods moist and can also be used to create two cooking

levels.

Not suitable for use with any of the grill functions (including "Dynamic Crisp").

Other accessories that are not supplied can be purchased separately from the After-sales Service.

There are a number of accessories available on the market. Before you buy, ensure they are suitable for microwave use and resistant to oven temperatures.

Metallic containers for food or drink should never be used during microwave cooking.

Always ensure that foods and accessories do not come into contact with the inside walls of the oven.

Always ensure that the turntable is able to turn freely before starting the oven. Take care not to unseat the turntable whilst inserting or removing other accessories.

FUNCTIONS



Download the Use and Care Guide at
docs.hotpoint.eu for more information



MICROWAVES

For quickly cooking and reheating food or drinks.

POWER	RECOMMENDED FOR
1000 W	Quickly reheating drinks or other foods with a high water content
800 W	Cooking vegetables
650 W	Cooking meat and fish
500 W	Cooking meaty sauces, or sauces containing cheese or egg. Finishing off meat pies or pasta bakes
350 W	Slow, gently cooking. Perfect for melting butter or chocolate
160 W	Defrosting frozen foods or softening butter and cheese
90 W	Softening ice cream



GRILL

For browning, grilling and gratins. We recommend turning the food during cooking. For best results, preheat the grill for 3-5 minutes.

Recommended accessories: Wire rack



GRILL + MICROWAVES

For quickly cooking and gratinating dishes, combining the microwave and grill functions.

Recommended accessories: Wire rack



CRISP DYNAMIC

For perfectly browning a dish, both on the top and bottom of the food. This function must only be used with the special crisp plate.

Required accessories: Crisp plate, handle for the Crisp plate



AUTOMATIC FUNCTIONS

With the automatic functions, simply select the type and weight or the quantity of the food items to obtain the best results. The oven will automatically calculate the optimum settings and continue to change them as cooking progresses. The total time does not include preheating phases.

REHEAT DYNAMIC

For reheating ready-made food that is either frozen or at room temperature.

The oven automatically calculates the settings required to achieve the best results in the shortest amount of time. Place food on a microwave-safe and heatproof dinner plate or dish.

CATEGORY	FOOD	WEIGHT
1	DINNER PLATE	250 - 500 g
2*	FROZEN PORTION	250 - 500 g
3*	FROZEN LASAGNA	250 - 500 g
4	SOUPS	200 - 800 g
5	BEVERAGES	1 - 5 dl

COOK DYNAMIC

For cooking foods quickly and achieving optimal results. Use a heatproof container suitable for microwave use.

CATEGORY	FOOD	WEIGHT
1	BAKED POTATOES (Turn when prompted)	200g - 1kg
2	FRESH VEGETABLES (Cut into pieces of equal size and add 2 to 4 tablespoons of water. Cover)	200 - 800 g
3*	FROZEN VEGETABLES (Turn when prompted. Cover)	200 - 800 g
4	CANNED VEGETABLES	200 - 600 g
5	POPCORN	100 g

CRISP DYNAMIC

For quickly reheating and cooking frozen foods and giving them a golden, crunchy top. Only use this function with the crisp plate provided. Turn the food when prompted.

CATEGORY	FOOD	WEIGHT
 1*	FRENCH FRIES (spread out in a single layer and sprinkle with salt before cooking)	200 - 600 g
 2*	PIZZA, THIN CRUST	200 - 500 g
 3*	PIZZA, THICK CRUST	300 - 800 g
 4*	CHICKEN WINGS, CHICKEN PIECES (Lightly oil the plate)	200 - 600 g
 5*	FISH FINGERS (Crisp plate must be preheated)	200 - 600 g

Recommended accessories: Crisp plate, handle for the Crisp plate

DEFROST DYNAMIC

For quickly defrosting various different types of food simply by specifying their weight. Food should be placed directly on the glass turntable.

Turn the food when prompted.

CATEGORY	FOOD	WEIGHT
 1*	MEAT (mince, cutlets, steaks, roasting joints)	100 g - 2 kg
 2*	POULTRY (whole chicken, pieces, fillets)	100 g - 2.5 kg
 3*	FISH (whole, steaks, fillets)	100 g - 1.5 kg
 4*	VEGETABLES (mixed vegetables, peas, broccoli, etc.)	100 g - 1.5 kg
 5*	BREAD (loaves, scones, rolls)	100 g - 1 kg

USING THE APPLIANCE FOR THE FIRST TIME

. SETTING THE TIME

You will need to set the time when you switch on the oven for the first time.



The two digits for the hour will start flashing: Turn the *adjustment knob* to set the hour and then press **OK** to confirm.





The two digits for the minutes will start flashing. Turn the *adjustment knob* to set the minutes and press **OK** to confirm.

Please note: To change the time at a later point, press and hold  for at least one second while the oven is off and repeat the steps above.

You may need to set the time again following lengthy power outages.

DAILY USE

1. SELECT A FUNCTION

When the oven is off, only the time is shown on the display. Press and hold  to switch the oven on. Turn the *knob* to view the main functions available on the left-hand display. Select one and press .



To select a sub-function (where available), select the main function and then press  to confirm and go to the function menu.

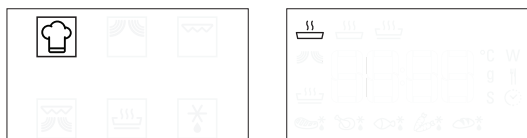

Turn the *knob* to select from amongst the sub-functions available on the right-hand display and then press  to confirm.

2. SET A FUNCTION

. MANUAL FUNCTIONS

After having selected the function you require, you can change its settings. The display will show the settings that can be changed in sequence.

MICROWAVE LEVEL





When the **W** icon flashes on the display, turn the *knob* to adjust the setting and then press  to confirm and continue to alter the settings that follow (if possible).

Please note: Once the function has been activated, the power can be changed by pressing  to access the settings menu, then turning the *knob* to change the setting.

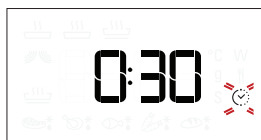
COOKING TIME



When the  icon flashes on the display, use the *knob* to set the cooking time you require and then press  to confirm and start the function.



Note: During cooking, you can adjust the cooking time by turning the *knob*; each time you press , the cooking time increases by 30 seconds.

. AUTOMATIC FUNCTIONS/DYNAMIC DEFROST

CATEGORIES

Once you have chosen one of the automatic functions, you will need to select a category for the food you are cooking.





When the  icon flashes, turn the *knob* to select the category you require and then press  to confirm.

WEIGHT

To achieve the best results, the automatic functions (and Dynamic Defrost) require you to enter the weight of the food, selecting from amongst the default settings: the oven will calculate the ideal length of time for the function to run for each category of food.



When the default setting appears on the display and the  icon flashes, turn the *knob* to set the weight and then press  to confirm.

3. ACTIVATE THE FUNCTION

Once you have applied the settings you require, press  to activate the function.

Every time the  button is pressed again, the cooking time will be increased by a further 30 seconds.

Please note: You can press  at any time to pause the function that is currently active.

JET START

When the oven is switched off, it is possible to press  to activate cooking with the microwave function set at full power (1000 W) for 30 seconds.

. SAFETY LOCK

This function is automatically activated to prevent the oven from being switched on accidentally.



Open and close the door, then press  to start the function.

4. PAUSE

To pause an active function, for example to stir or turn the food, simply open the door.

To start it up again, close the door and press .

AUTOMATIC PAUSE (STIR OR TURN THE FOOD)

Certain functions will pause to allow you to turn or stir the food.



Once the oven has paused cooking, open the door and carry out the action you are prompted to perform before

closing the door again and pressing  to continue with cooking.

Please note: When using the "Dynamic Defrost" functions, the function will start again automatically after two minutes, even if you have not turned or stirred the food.

5. COOKING END TIME

An audible signal will sound and the display will indicate that cooking is complete.



To extend the cooking time without changing the settings, turn the *knob* to set a new cooking time and press .

. KEY LOCK

To lock the keypad, press and hold  for at least 5 seconds.















































Do this again to unlock the keypad.

Please note: The key lock can also be activated while cooking is in progress.

For safety reasons, the oven can be switched off at any time by pressing and holding .







COOKING TABLE

FOOD	FUNCTION	PRE HEATING	POWER (W)	TIME (MIN)	ACCESSORIES
Sponge cake		-	-	7 - 15	
Fruit pie		-	-	12 - 20	
Cookies		-	-	5 - 10	
Savoury bakes or quiche lorraine (1 - 1.2 kg)		-	-	18 - 25	
Ready meals (250 - 500 g)		-	750	4 - 7	-
Lasagne/pasta bake		-	350 - 500	15 - 40	 
Frozen lasagne (500 - 700 g)		-	500 - 750	14 - 20	-
Pizza (300 g)		-	-	14 - 16	
Meat (chops, steak)		-	500	10 - 15	 
Poultry (whole, 800 g - 1.5 kg)		-	350 - 500	30 - 45 *	 
Chicken fillets or pieces		-	350 - 500	10 - 17	 
Roasts		-	350 - 500	25 - 40 *	 
Sausages/kebabs		-	-	20 - 40 *	
Sausages/hamburgers		Yes **	-	6 - 16 *	
Fish (steaks or fillets)		Yes	160 - 350	15 - 30 *	 
Whole fish		-	160 - 350	20 - 40 *	 
Roast potatoes		-	350 - 500	30 - 50 *	 
Potato wedges		-	-	25 - 30	
Baked apples		-	160 - 350	15 - 25	 

* Turn the food halfway through cooking.

** Preheat the Crisp plate for 3-5 minutes.

 [www](http://www.docs.hotpoint.eu) Download the Use and Care Guide from docs.hotpoint.eu to consult the table of tested recipes, which has been compiled for the certification authorities in accordance with the IEC 60350 standard

FUNCTIONS	Crisp 	Grill 	Grill + Microwaves 
ACCESSORIES	Heatproof plate/container suitable for use in microwaves 	Wire rack 	Crisp plate 

CLEANING

Make sure that the oven has cooled down before carrying out any maintenance or cleaning.

Do not use steam cleaners.

Do not use wire wool, abrasive scourers or abrasive/corrosive cleaning agents, as these could damage the surfaces of the appliance.

INTERIOR AND EXTERIOR SURFACES

- Clean the surfaces with a damp cloth. If they are very dirty, add a few drops of pH-neutral detergent. Finish off with a dry cloth.
- Clean the door glass with a suitable liquid detergent.
- At regular intervals or in case of spills, remove the turntable and its support to clean the bottom of the oven, removing all food residue.
- The grill does not need to be cleaned as the intense heat burns away any dirt: Use this function on a regular basis.

ACCESSORIES

All accessories are dishwasher safe with the exception of the crisp plate. The crisp plate should be cleaned using water and a mild detergent. For stubborn dirt, rub gently with a cloth. Always leave the crisp plate to cool down before cleaning.

TROUBLESHOOTING



Download the Use and Care Guide at docs.hotpoint.eu for more information

Problem	Possible cause	Solution
The oven is not working.	Power cut. Disconnection from the mains.	Check for the presence of mains electrical power and whether the oven is connected to the electricity supply. Turn off the oven and restart it to see if the fault persists.
The oven makes noises, even when it is switched off.	Cooling fan active.	Open the door or wait until the cooling process has finished.
The display shows the letter "F" followed by a letter or number.	Software fault.	Contact your nearest After-sales Service Centre and state the letter or number that follows the letter "F".

PRODUCT FICHE

The product fiche with energy data of this appliance can be downloaded from the website docs.hotpoint.eu

HOW TO OBTAIN THE USE AND CARE GUIDE

> Download the Use and Care Guide from our website docs.hotpoint.eu (you can use this QR Code), specifying the product's commercial code.



> Alternatively, contact our Client After-sales Service

CONTACTING OUR AFTER-SALES SERVICE

You can find our contact details in the warranty manual. When contacting our Client After-sales Service, please state the codes provided on your product's identification plate.

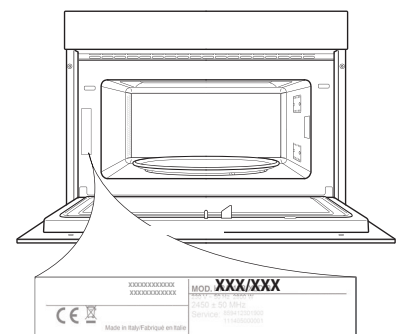

400010886703

Printed in Italy