

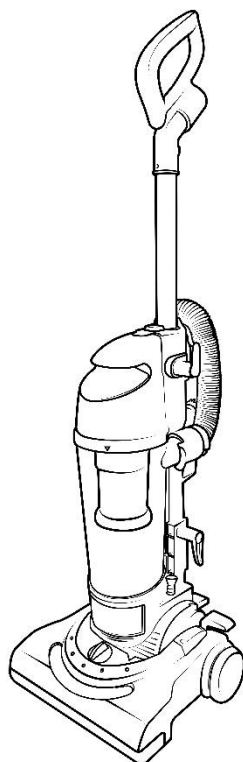

# Russell Hobbs

At the heart of your home

## Compact Cyclonic Pro Bagless Upright Vacuum Cleaner



**Model Number: RHUV2004**

For Customer Services & Spare Parts please call **0345 209 7461**  
Opening times: Monday - Friday 8am – 8pm & Saturday 9am – 1pm  
Or visit us at [www.productcare.co.uk](http://www.productcare.co.uk)

**PLEASE RETAIN**  
**FOR FUTURE REFERENCE**

# CONTENTS

	Page(s)
Safety instructions	3-6
Energy performance label	7
Vacuum feature diagram	8
Vacuum cleaner assembly	9-10
Using your vacuum cleaner	11-13
Cleaning and care	14-15
Problem solving	16
Guarantee and customer services	17
Spare parts	18
Connection to the mains supply	19-20
Disposal information	24

Thank you for purchasing your Russell Hobbs Compact Cyclonic Pro Upright Vacuum Cleaner.

To get the best from your new cleaner, take a few moments to read these instructions and keep them in a safe place for future reference.

Should you require any further assistance, our friendly Product Care team will be happy to help.

For Customer Services & Spare Parts please call **0345 209 7461**  
Opening times: Monday - Friday 8am – 8pm & Saturday 9am – 1pm  
Or visit us at **[www.productcare.co.uk](http://www.productcare.co.uk)**



# **SAFETY INSTRUCTIONS**

## **IMPORTANT SAFETY INSTRUCTIONS** **READ CAREFULLY AND KEEP FOR FUTURE REFERENCE**

### **WARNING:**

- It is hazardous for anyone other than a competent person to carry out any service or repair operation that involves the removal of a cover which gives protection against exposure to electrical parts.
- If the supply cord is damaged, it must be replaced by the manufacturer, its service agent or similarly qualified persons in order to avoid a hazard.
- This product is intended for household use only. Do not use outdoors.
- This appliance can be used by children aged from 8 years and above and persons with reduced physical, sensory or mental capabilities or lack of experience and knowledge if they have been given supervision or instruction concerning use of the appliance in a safe way and understand the hazards involved. Children shall not play with the appliance. Cleaning and user maintenance shall not be made by children without supervision.
- Do not operate this appliance for anything other than its intended use. This product is intended for household use only. Do not use outdoors.
- Do not immerse in water or other liquids for cleaning.

# **SAFETY INSTRUCTIONS**

## **IMPORTANT SAFETY INSTRUCTIONS**

### **READ CAREFULLY AND KEEP FOR FUTURE REFERENCE**

- Do not direct at people, animals, electrical outlets, or equipment containing electrical components.
- Unplug from outlet when not in use. Do not leave the cleaner unattended while plugged in.
- Do not use with damaged cord or plug.
- Do not use vacuum cleaner if it has been dropped, damaged, left outdoors or dropped into water.
- Keep the vacuum cleaner away from water; do not allow it to get wet. If unit is wet, do not plug unit into wall socket or turn unit on.
- Do not handle the vacuum cleaner with wet hands.
- Do not pull or carry by cord, use cord as a handle, close door on cord, pull cord around sharp corners or edges, or expose cord to heated surfaces.
- Do not unplug by pulling on cord.
- To protect against electrical shock do not immerse cord, plug, or appliance in water or other liquid.
- Unplug from the mains outlet when not in use, before putting on and taking off parts, and before cleaning.
- The use of accessory attachments not recommended by the appliance manufacturer may cause fire, electric shock or injury. Only use the accessories supplied by the manufacturer.



# **SAFETY INSTRUCTIONS**

## **IMPORTANT SAFETY INSTRUCTIONS** **READ CAREFULLY AND KEEP FOR FUTURE REFERENCE**

### **WARNING:**

- Do not let the cord hang over the edge of the worktop, or touch hot surfaces.
- Do not use this vacuum to pick up water or any other liquids, combustible substances or hot/burning objects.
- Only use the unit when fully assembled.
- Never place your fingers or other objects into any part of the cleaner. Be aware that loose clothing or hair may become trapped in the cleaner if improperly used.
- Before use, ensure that all of the air vents of the cleaner are clear and there is no restriction of air flow.
- This vacuum cleaner is fitted with a constantly rotating brush bar. To avoid damage to your flooring, make sure the brush bar is raised to the highest setting when using the accessories or hose.
- Caution: Exhaust air discharged from the rear of the cleaner may extinguish a gas fire, pilot light, or disturb ashes in an open fire. Always avoid directing the cleaner toward naked flames.

# SAFETY INSTRUCTIONS

## IMPORTANT SAFETY INSTRUCTIONS

### READ CAREFULLY AND KEEP FOR FUTURE REFERENCE

- When cleaning stairs to prevent the vacuum cleaner falling always place the vacuum cleaner at the bottom of stairs on the floor. Do not place the vacuum cleaner on stairs or furniture.
- When cleaning stairs with the hose and attachments, ensure the brush bar is raised to the highest setting.
- **Important:** This cleaner has a thermal safety device which automatically cuts off the power supply in case of over heating. If the safety device has switched the cleaner off, unplug from the mains, allow the cleaner to cool down and check for any blockages. Once the cleaner has cooled it can be plugged back in to the mains and used as normal.

For Customer Services & Spare Parts please call **0345 209 7461**  
Opening times: Monday - Friday 8am – 8pm & Saturday 9am – 1pm  
Or visit us at **[www.productcare.co.uk](http://www.productcare.co.uk)**



# ENERGY PERFORMANCE LABEL

The purpose of the energy label is to help you understand a vacuum cleaner's energy efficiency performance.

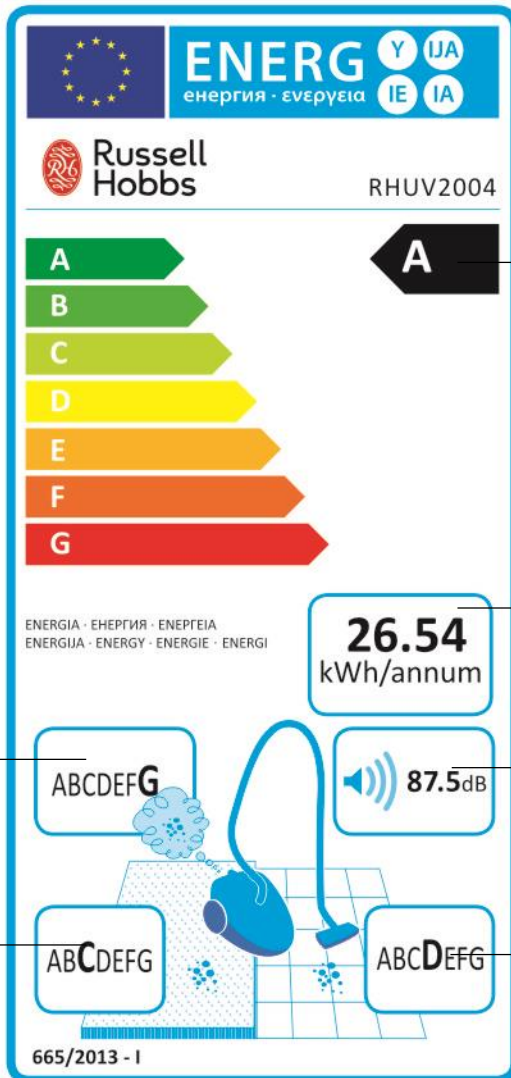

**1. Energy rating** – based primarily on energy consumption and pick-up.

**2. Annual energy usage** – the amount of energy used over a year.

**3. Emissions** – the amount of dust in the air emitted from the machine's exhaust.

**4. Noise** – the noise level produced by the machine, measured in decibels.

**5. Pick up (carpets)** – the rating of how much dust the machine picks up from carpets.

**6. Pick-up (hard floors/crevices)** – the rating of how much dust the machine picks up from hard floors and crevices.

# VACUUM FEATURE DIAGRAM

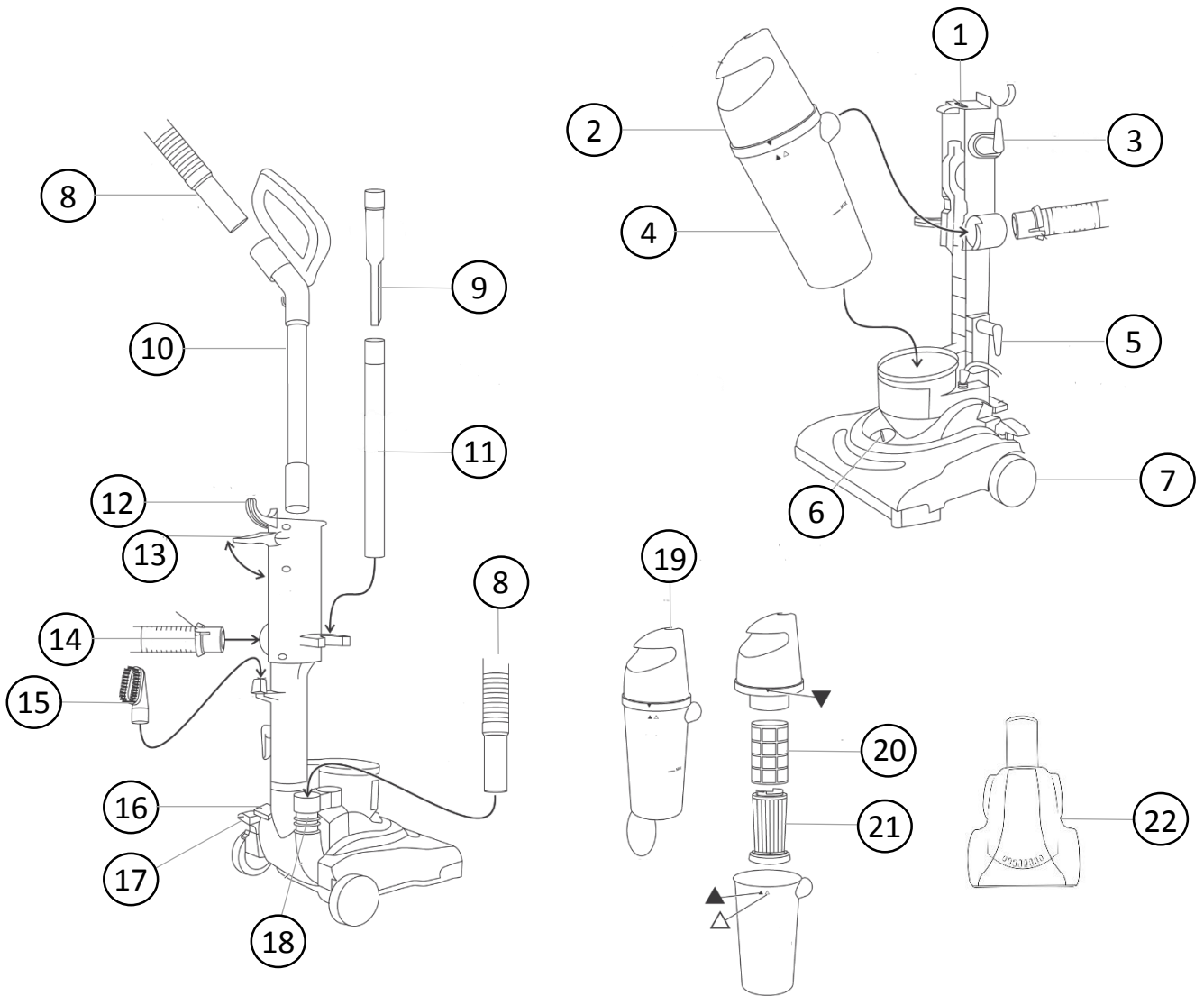

- |          |                               |           |                     |           |                          |           |                               |
|----------|-------------------------------|-----------|---------------------|-----------|--------------------------|-----------|-------------------------------|
| <b>1</b> | Dust container release button | <b>7</b>  | Wheel               | <b>13</b> | Handle securing clip     | <b>19</b> | Dust container release button |
| <b>2</b> | Dust container lid            | <b>8</b>  | Hose nozzle         | <b>14</b> | Hose clip                | <b>20</b> | Mesh filter                   |
| <b>3</b> | Upper cord hook               | <b>9</b>  | Crevice tool        | <b>15</b> | Brush tool               | <b>21</b> | HEPA filter                   |
| <b>4</b> | Dust container                | <b>10</b> | Handle              | <b>16</b> | Power button             | <b>22</b> | Turbo brush                   |
| <b>5</b> | Lower cord hook               | <b>11</b> | Hose extension tube | <b>17</b> | Floor head release pedal |           |                               |
| <b>6</b> | Brush height control dial     | <b>12</b> | Hose hook           | <b>18</b> | Hose inlet               |           |                               |



# VACUUM CLEANER ASSEMBLY

## **Before using your vacuum cleaner**

Remove all packaging and lay out the separate components.

Check the unit after unpacking for any visual damage such as:

- Misaligned or damaged parts
- Damage to the main body and separate components
- Damage to the plug or cable.

If you can see any damage do not use the vacuum cleaner and contact customer services.

For Customer Services & Spare Parts please call **0345 209 7461**  
Opening times: Monday - Friday 8am – 8pm & Saturday 9am – 1pm  
Or visit us at **[www.productcare.co.uk](http://www.productcare.co.uk)**

# VACUUM CLEANER ASSEMBLY

**Ensure the unit is unplugged before assembling.**

**1.** Place the dust container onto the unit, base first, then tilt forward to engage the top. To remove, press the dust container release button, located next to the handle.

**Note:** Do not carry the unit using the dust container.

**2.** With the handle securing clip lifted upwards, insert the handle into the main body, aligning the plastic rib with the groove in the handle inlet.

**Important:** Ensure you press down the securing clip located on the back of the unit below the hose hook to secure the handle in place.

**3.** The hose wraps around the hook located above the handle securing clip. The nozzle is placed into the brush hose inlet. To remove the hose for use, gently pull it out from the hose inlet.

**4.** The extension tube is stored on board the vacuum, located next to the hose inlet, with the crevice tool inserted into the top of the hose.

**5.** The brush tool is stored on board the vacuum, located on the back of the unit below the handle securing clip.

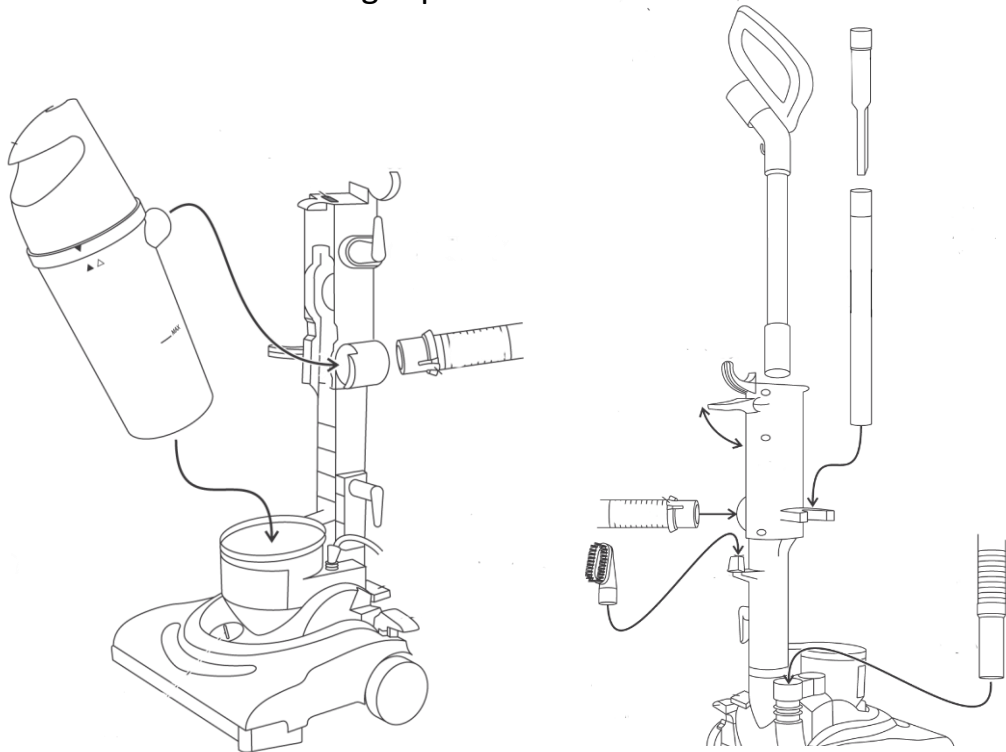

# USING YOUR VACUUM CLEANER

1. Unwrap the cord from the hooks.
  2. Ensure the correct surface type is selected using the brush height control dial. Refer to diagram (2) below. Suction will be most powerful when the “HARD FLOOR/SHORT PILE” mode is selected.
- Important note:** Use the “TOOLS” setting when cleaning with the additional tools to prevent the brush continually hitting the surface it’s sitting on.
3. Plug the cable into a wall socket and press the switch on.
  4. With your foot press in the floor head release pedal and tilt the handle back ready for use. Remove your foot.
  5. Press the power button to start vacuuming.
  6. Move the vacuum cleaner floor head in a forwards and backwards motion over the areas you would like to clean.

**Note:** Large items can get trapped in the brush/floor head which could cause the unit to overheat. Make sure you pick up larger items that could get trapped before vacuuming.

**Switch off:** Before changing vacuum use in any way or when finished.

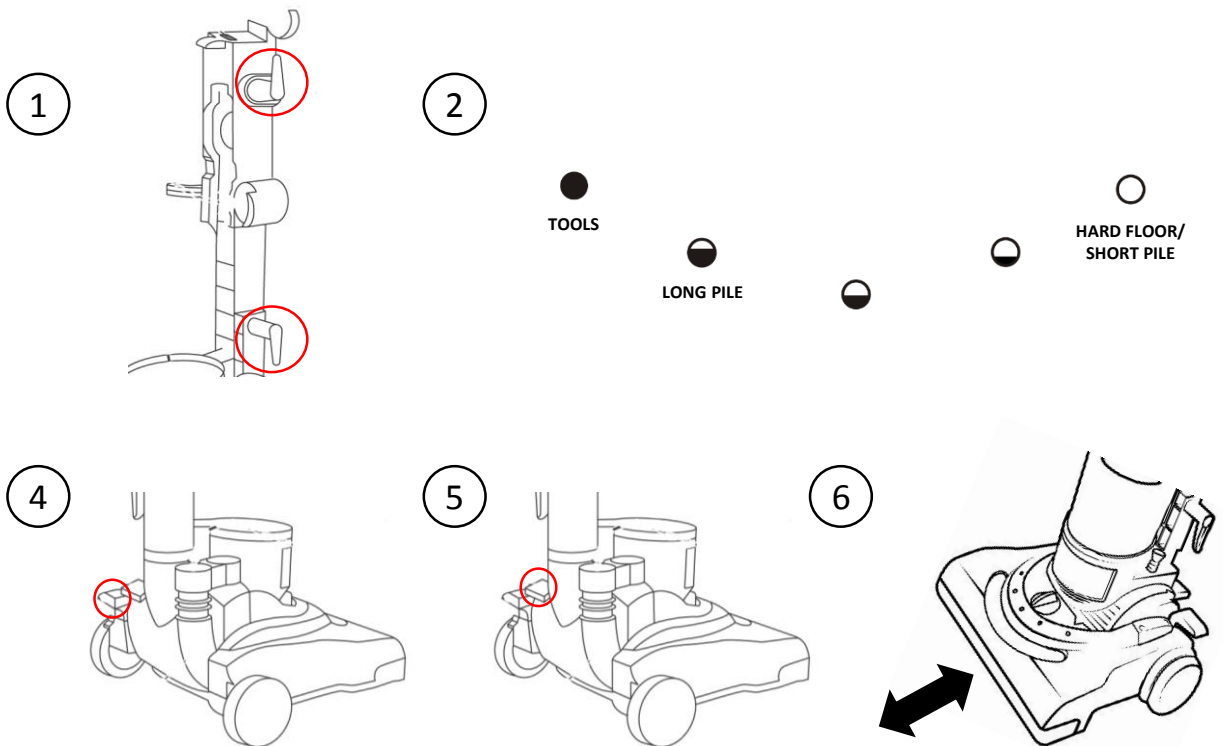

# USING YOUR VACUUM CLEANER

**Using the tools** - for reaching areas above the floor.



1. Raise the handle securing clip and pull the handle out of the main unit.
2. Gently pull the hose out of the inlet and secure it into the inlet on the handle.
3. Push the tool you are going to use inside the other end of the handle.

Note: Ensure the floor surface selector dial is set to 'TOOLS'.

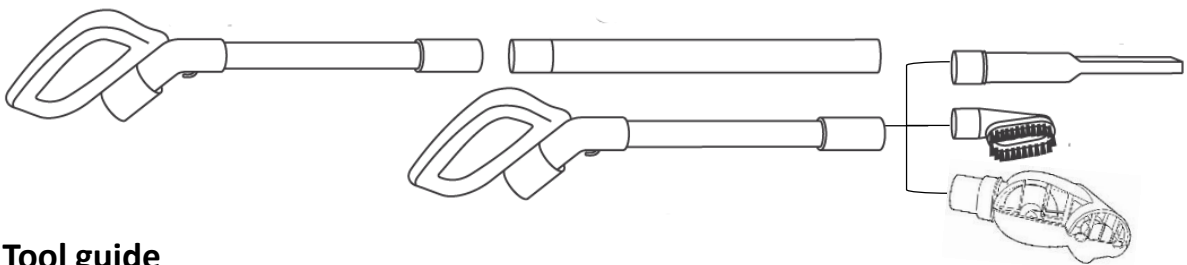
4. Turn the power on.

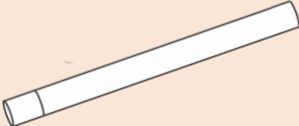

## Tool guide

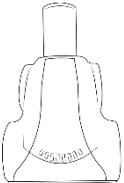
Extension tube 	Attach the extension tube to the bottom of the handle for added reach.
Crevice tool 	Attach the crevice tool to either the extension tube or the handle for narrow, hard to reach areas like down the sides of the sofa.
Brush tool 	Attach the brush tool to either the extension tube or the handle to remove dust and hair from upholstery, curtains and blinds.
Turbo brush 	Attach the turbo brush to either the extension tube or the handle for an extra effective pick up of fluff, hair and threads from a variety of furnishings.

# USING YOUR VACUUM CLEANER

## Emptying the dust container

When the dust container reaches the 'MAX' level it will need to be emptied.

1. To remove the dust container, press the release button located next to the handle.
2. Lift the container away from the unit base.
3. Locate the bin release button on the top of the lid.
4. Over a bin, push the release button to open the base of the container. You may need to tap the sides to empty all of the dirt. Close the base to secure.

### Important:

You may wish to empty the dust container outdoors as emptying could create a dust cloud.

Place the dust container onto the unit, base first, then tilt forward to engage the top.



# CLEANING AND CARE: CLEANING THE FILTER

Before you clean the appliance, disconnect the mains plug from the wall socket.

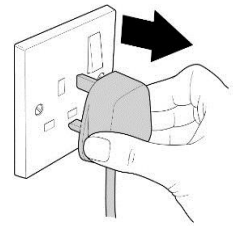

## Cleaning the filter

1. To remove the dust container, press the release button located next to the handle.
2. Lift the container away from the unit base.
3. Turn the bin assembly to align the ▼ on the lid with the ▲ on the bin.
4. Lift the lid and filters out of the bin.
5. Grip the bottom of the HEPA filter with one hand, and the bin handle with the other.
6. Turn the HEPA filter anti-clockwise to release it from the lid, and pull it away from the lid.
7. Slide the mesh filter up and off the HEPA filter. **Note:** Don't handle the paper part of the HEPA filter, oils from your skin can cause dust particles to adhere to it.

## The mesh filter

8. Wash the filter assembly and mesh filter in warm soapy water.
9. Leave it to air dry – don't refit it until it is completely dry.
10. Unscrew the top of the filter unit from the HEPA filter.

## The HEPA filter

This filters the returning airflow.

12. If the filter looks a bit dirty, tap it over some newspaper, to dislodge the dirt.
13. If it's very dirty, soak it in warm soapy water for a few minutes, rinse under a running tap to remove all trace of soap, then let it air dry – do not refit until it's completely dry.

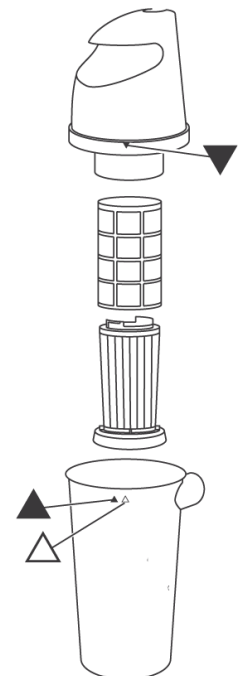

# CLEANING AND CARE

## Refitting the filters

14. Slide the mesh filter over the HEPA filter – it only fits one way, with the broader plastic band at the top.
15. Replace the HEPA filter in the bin lid, and turn it clockwise, to lock it in place.
16. Align the ▼ on the lid with the △ on the bin.
17. Fit the lid to the bin, then turn it to align the ▼ on the lid with the ▲ on the bin.
18. Replace the bin in the cleaner.

To clean the exterior of the device, use a damp, soft cloth and mild detergent.

### **NEVER IMMERGE THE VACUUM IN WATER.**

Wash non-electrical removable accessories in warm soapy water and allow to dry thoroughly before next use.

If the vacuum is damaged, contact the customer service helpline using the details at the bottom of this page.

## Storage

Store in a clean and dry environment.

For Customer Services & Spare Parts please call **0345 209 7461**  
Opening times: Monday - Friday 8am – 8pm & Saturday 9am – 1pm  
Or visit us at **[www.productcare.co.uk](http://www.productcare.co.uk)**



# PROBLEM SOLVING

<b><u>PROBLEM</u></b>	<b><u>POSSIBLE PROBLEM</u></b>	<b><u>POSSIBLE SOLUTION</u></b>
<b><i>The vacuum cleaner is plugged in but does not work</i></b>	Power cord/plug damage	Check the power cord and plug for signs of damage.
	Fuse is damaged	Check and replace the fuse in the plug.
<b><i>The suction is decreasing and the vacuum is not picking up dirt</i></b>	Dust container	Check if the dust container is full, if so, empty it.
	Filters are dirty	Clean the filters.
	Hose/head blockages	Check that there are no blockages in the hose or cleaning head.
<b><i>Vacuum cleaner is over heating</i></b>	Filters are dirty	Check that the filters are not blocked, if so, clean them following the instructions in this booklet.
<b><i>Dust is coming out of the vacuum cleaner</i></b>	Dust container fitting	The dust container has not been fitted correctly. Refit the container following the instructions in this booklet.
<b><i>The air coming out of the vacuum cleaner smells</i></b>	Filters are dirty	Clean the filters. Also clean the hose and dust container
	Filters are not dry	Ensure the filters have been left to dry for 24 hours befo.re refitting back into the vacuum cleaner and using.

**We're here should you need us.**

For Customer Services & Spare Parts please call 0345 209 7461  
 Opening times: Monday - Friday 8am – 8pm & Saturday 9am – 1pm  
 Or visit us at [www.productcare.co.uk](http://www.productcare.co.uk)



# **GUARANTEE AND CUSTOMER SERVICES**

At Russell Hobbs, we take all our customer feedback seriously.

**Feel free to contact our Product Care Team, on 0345 209 7461**

**Monday – Friday: 8am-8pm & Saturday: 9am – 1pm,**

**who will be more than happy to assist you.**

This product is guaranteed for **12 months** from the date of the original purchase. If any defect arises due to faulty materials or workmanship, the faulty product must be returned to the place of purchase.

Refund or replacement is at the discretion of the retailer.

## **The following conditions apply:**

- The product must be returned to the retailer with the original proof of purchase.
- The product must be installed and used in accordance with the instructions contained in this instruction guide and any other instructions for use which are supplied.
- It must be used for domestic purposes only and for its intended use.
- This warranty does not cover wear and tear, damage, misuse or consumable parts.

**This does not affect your statutory rights.**

For Customer Services & Spare Parts please call **0345 209 7461**  
Opening times: Monday - Friday 8am – 8pm & Saturday 9am – 1pm  
Or visit us at **[www.productcare.co.uk](http://www.productcare.co.uk)**



# SPARE PARTS

To check the availability of the following spare parts, simply contact our friendly Customer Services team using the details provided at the bottom of this page.

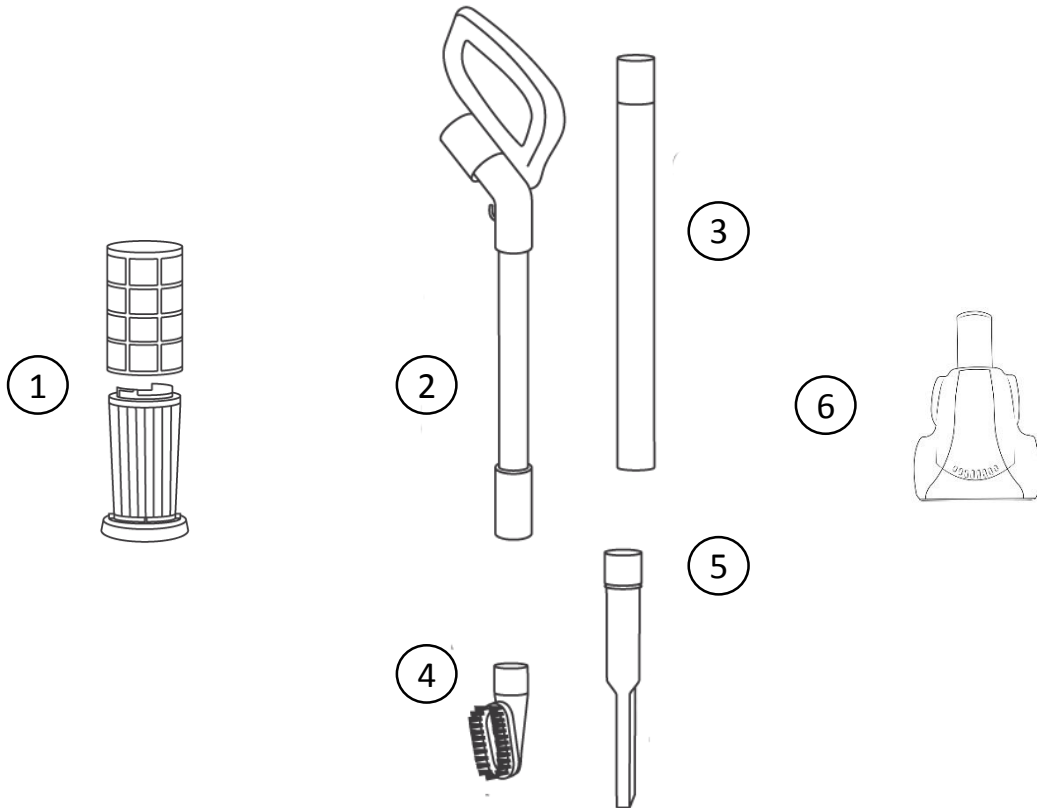

1 Dust container filter assembly

2 Handle

3 Extension tube

4 Brush tool

5 Crevice tool

6 Turbo brush

For Customer Services & Spare Parts please call **0345 209 7461**  
Opening times: Monday - Friday 8am – 8pm & Saturday 9am – 1pm  
Or visit us at [www.productcare.co.uk](http://www.productcare.co.uk)

# CONNECTION TO THE MAINS SUPPLY

This appliance is designed to operate from a mains supply of  
220-240V~ 50Hz.

Check that the voltage marked on the product corresponds  
with your supply voltage.

This product is fitted with a 13A plug complying with BS1363.  
If this plug is unsuitable or needs to be replaced, refer to customer  
services.

Important: The wires in the mains lead are coloured in  
accordance with the following code:

**GREEN/YELLOW** – EARTH

**BLUE** - NEUTRAL

**BROWN** – LIVE

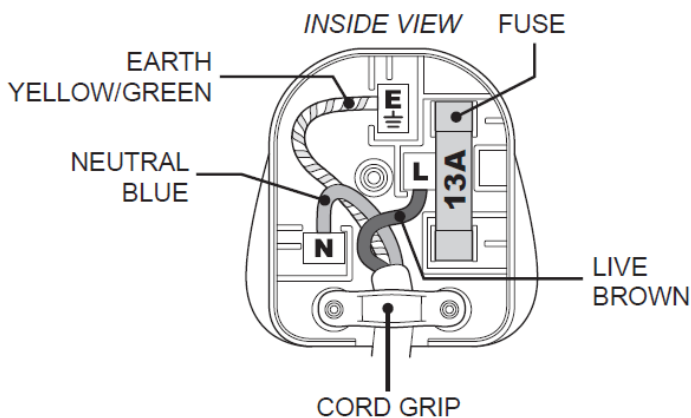

# CONNECTION TO THE MAINS SUPPLY

## For UK use only – PLUG

- As the colours of the wires in the mains lead of this appliance may not correspond with the coloured markings identifying the terminals in your plug, proceed as follows:
- The **GREEN/YELLOW** wire is the EARTH and must be connected to the terminal which is marked with the letter E or by the earth symbol or coloured **GREEN** or **GREEN/YELLOW**.
- The **BLUE** wire is the NEUTRAL and must be connected to
- the terminal marked with the letter N or coloured **BLACK**.
- The **BROWN** wire is the LIVE wire and must be connected to
- the terminal marked with the letter L or coloured **RED**.
- **Always ensure that the plug cord grip is fastened correctly.**
- If a 13A (BS1363) fused plug is used it must be fitted with a
- 13amp fuse conforming to BS1362 and be BSI or ASTA approved.

If the fuse cover is lost the plus must not be used until a replacement is obtained from an electrical supplier.

If you need to remove the plug, cut it from the mains lead and dispose of it. NEVER attempt to re-use this plug or insert it into a socket outlet, as there is a very great risk of electrical shock.

# NOTES

A large, empty rectangular box with rounded corners and a thin green border, intended for taking notes.



# NOTES

A large, empty rectangular box with rounded corners and a thin green border, intended for taking notes.



# NOTES

A large, empty rectangular box with rounded corners and a thin green border, intended for taking notes.



# Russell Hobbs

At the heart of your home

For Customer Services & Spare  
Parts please call

**0345 209 7461**

Opening times: Monday - Friday  
8am – 8pm & Saturday 9am – 1pm

Or visit us at

**[www.productcare.co.uk](http://www.productcare.co.uk)**

Revision 7

Model: **RHUV2004**

Produced for:

**G2S Ltd,**

**Wigan,**

**WN2 4AY**

**CE**



This symbol is known as the 'Crossed-out wheellie bin Symbol'. When this symbol is marked on a product/batteries, it means that the product/batteries should not be disposed of with your general household waste. Only discard electrical/electronic/battery items in separate collection schemes, which cater for the recovery and recycling of materials contained within. Your co-operation is vital to ensure the success of these schemes and for the protection of the environment. For your nearest disposal facility, visit [www.recycle-more.co.uk](http://www.recycle-more.co.uk) or ask in store for details.

We reserve the right, due to possible changes to design, to alter the instruction manual without prior notice.

24



Russell Hobbs