

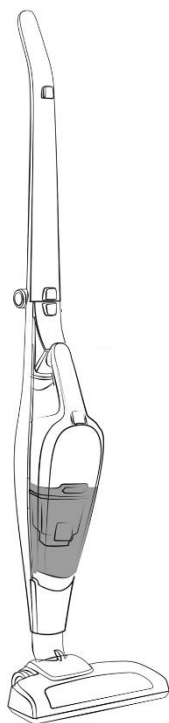

# Russell Hobbs

At the heart of your home

## Turbo Vac Pro 16V 2 in 1 Cordless Cleaner



**Model Number: RHSV1601**

For Customer Services & Spare Parts please call **0345 209 7461**  
Opening times: Monday - Friday 8am – 8pm & Saturday 9am – 1pm  
Or visit us at [www.productcare.co.uk](http://www.productcare.co.uk)

**PLEASE RETAIN**  
**FOR FUTURE REFERENCE**

# CONTENTS

	Page(s)
Safety instructions	3-6
Turbo Vac feature diagram	7
Turbo Vac assembly	8-9
Charging your Turbo Vac	10
Using your Turbo Vac	11-13
Cleaning and care	14-15
Problem solving	16
Guarantee and customer services	17
Spare parts	18
Disposal information	20

Thank you for purchasing your Turbo Vac Pro 16V 2 in 1 Cordless Cleaner.

To get the best from your new cleaner, take a few moments to read these instructions and keep them in a safe place for future reference.

Should you require any further assistance, our friendly Product Care team will be happy to help.

For Customer Services & Spare Parts please call **0345 209 7461**  
Opening times: Monday - Friday 8am – 8pm & Saturday 9am – 1pm  
Or visit us at **[www.productcare.co.uk](http://www.productcare.co.uk)**



# **SAFETY INSTRUCTIONS**

## **IMPORTANT SAFETY INSTRUCTIONS** **READ CAREFULLY AND KEEP FOR FUTURE REFERENCE**

### **WARNING:**

- **It is hazardous for anyone other than a competent person to carry out any service or repair operation that involves the removal of a cover which gives protection against exposure to electrical parts.**
- **This product is intended for household use only. Do not use outdoors.**
- **This appliance can be used by children aged from 8 years and above and persons with reduced physical, sensory or mental capabilities or lack of experience and knowledge if they have been given supervision or instruction concerning use of the appliance in a safe way and understand the hazards involved. Children shall not play with the appliance. Cleaning and user maintenance shall not be made by children unless they are older than 8 and supervised. Keep the appliance and its cord out of reach of children less than 8 years.**
- **Only use the charger provided with the product. Using another charger may damage the product and battery.**
- **Do not immerse in water or other liquids for cleaning.**
- **Do not store or charge the unit outdoors**
- **Do not use outdoors or on wet surfaces**
- **Do not handle the charger or appliance with wet hands**
- **Use only as described in this manual**

# **SAFETY INSTRUCTIONS**

## **IMPORTANT SAFETY INSTRUCTIONS** **READ CAREFULLY AND KEEP FOR FUTURE REFERENCE**

### **WARNING:**

- **Do not attempt to use the charger with any other product nor attempt to charge this product with another charger**
- **Do not abuse the charger cord; never carry the charger or base by the cord or pull cord to disconnect from an outlet; grasp the charger and pull to disconnect from an outlet.**
- **Keep hair, clothing, fingers, and all parts of the body clear of moving parts.**
- **Do not pick up anything that is flammable, burning or smoking.**
- **Use extra care when cleaning on the stairs.**
- **Never remove parts from the appliance such as the feet, screws and so on.**
- **Only use the accessories supplied by the manufacturer.**
- **Do not operate this appliance for anything other than its intended use.**
- **Never put any objects into the openings on the outer case.**
- **This appliance is authorized for household/residential use only**
- **Do not allow to be used as a toy. Close attention is necessary when used by or near children.**

# **SAFETY INSTRUCTIONS**

## **IMPORTANT SAFETY INSTRUCTIONS** **READ CAREFULLY AND KEEP FOR FUTURE REFERENCE**

### **WARNING:**

- **Children should be supervised to ensure they don't play with the appliance.**
- **Use only as described and for the uses described in this manual**
- **Do not use the charger if power cord or plug has been damaged.**
- **Do not use cordless sweeper or charger if it has been dropped, damaged, left outdoors, or dropped in water. Contact customer services for advice.**
- **Do not run over charger cord with sweeper. Always unplug charger from sweeper before use.**
- **Never carry the charger by the cord, or yank to disconnect from an outlet, to unplug, always grasp the plug to remove from outlet, do not pull on cord.**
- **Keep charger cord away from heated surfaces(e.g., cooking surfaces).**
- **Do not handle charger cord or sweeper with wet hands or while barefoot.**
- **Do not put any objects into openings. Do not use with any opening blocked, keep free of dust, lint, hair and anything that may reduce particle flow into the dust container.**
- **Do not use the sweeper without dust container in place.**

# **SAFETY INSTRUCTIONS**

## **IMPORTANT SAFETY INSTRUCTIONS** **READ CAREFULLY AND KEEP FOR FUTURE REFERENCE**

- **Do not attempt to empty dust container while unit is running, always turn off the appliance and unplug before emptying/replacing the dust container.**
- **Turn off sweeper before clearing debris from floor brush assembly**

For Customer Services & Spare Parts please call **0345 209 7461**  
Opening times: Monday - Friday 8am – 8pm & Saturday 9am – 1pm  
Or visit us at **[www.productcare.co.uk](http://www.productcare.co.uk)**



# TURBO VAC FEATURE DIAGRAM

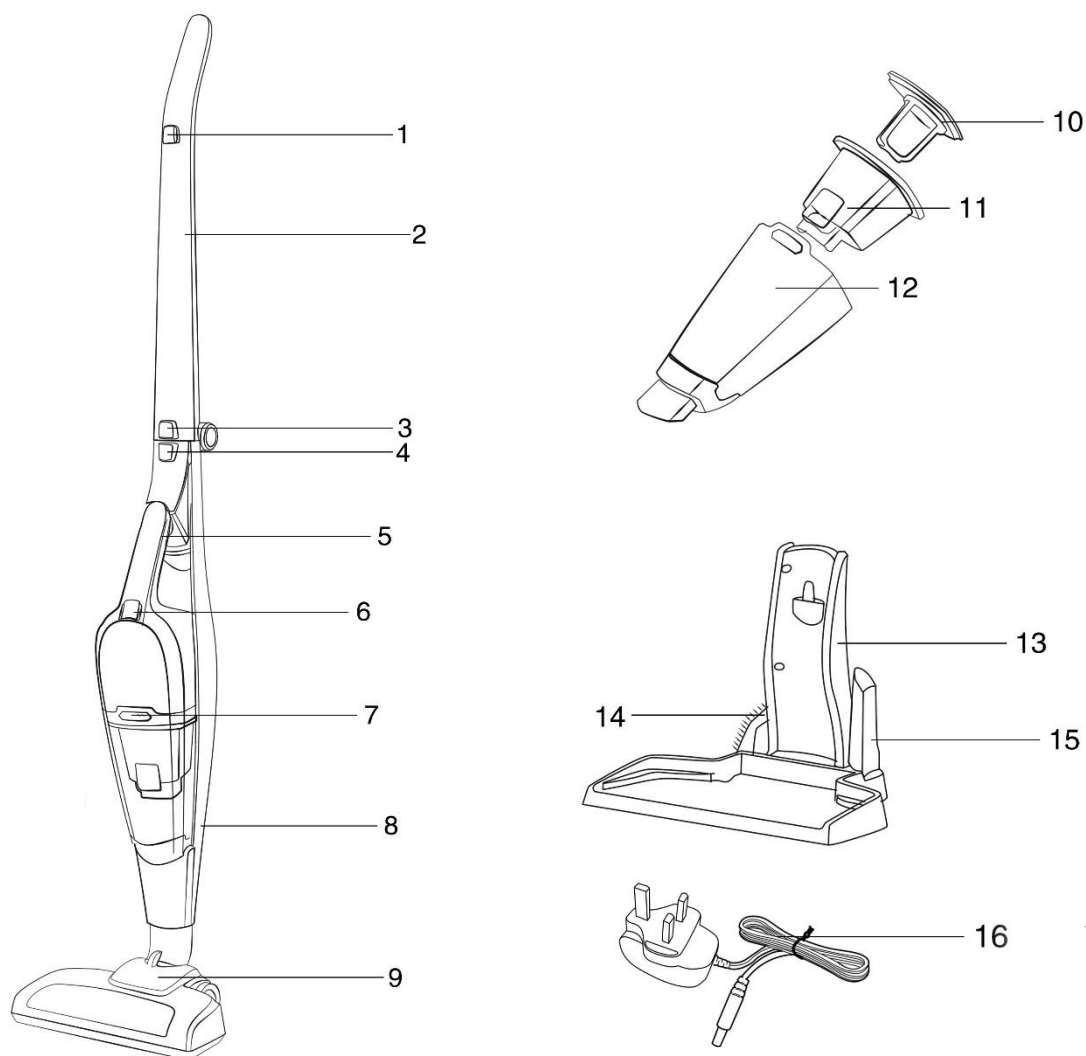

<b>1</b>	Main unit power button	<b>7</b>	Dust container release	<b>13</b>	Charging stand
<b>2</b>	Handle	<b>8</b>	Vac unit frame	<b>14</b>	Brush tool
<b>3</b>	Handle release button	<b>9</b>	Floor head	<b>15</b>	Crevice tool
<b>4</b>	Handheld vac release button	<b>10</b>	Filter	<b>16</b>	Charging cable
<b>5</b>	Handheld vac handle	<b>11</b>	Filter cup		
<b>6</b>	Handheld power button/charging indicator	<b>12</b>	Dust container		

For Customer Services & Spare Parts please call **0345 209 7461**  
 Opening times: Monday - Friday 8am – 8pm & Saturday 9am – 1pm  
 Or visit us at [www.productcare.co.uk](http://www.productcare.co.uk)



# TURBO VAC ASSEMBLY

## **Before using your cleaner**

Remove all packaging and lay out the separate components.

Check the unit after unpacking for any visual damage such as:

- Misaligned or damaged parts
- Damage to the main body and separate components
- Damage to the plug or cable.

If you can see any damage do not use the cleaner and contact customer services.

For Customer Services & Spare Parts please call **0345 209 7461**  
Opening times: Monday - Friday 8am – 8pm & Saturday 9am – 1pm  
Or visit us at **[www.productcare.co.uk](http://www.productcare.co.uk)**





# TURBO VAC ASSEMBLY

**Ensure the power is switched off before assembling.**

- 1.** Insert the assembled handheld vacuum unit into the main frame as shown on the diagram - suction inlet first then securing the handle into place.
- 2.** Align the bottom of the frame with the connectors on the ball joint of the floor head, lowering the frame until it 'clicks' into place and secures. Ensure the pins are correctly aligned. Tilt the cleaner forward so it stands up independently.
- 3.** Lift the main handle up until it 'clicks' into place.  
**Note:** Take care not to trap skin or hair.
- 4.** The main vacuum unit is now assembled.

1

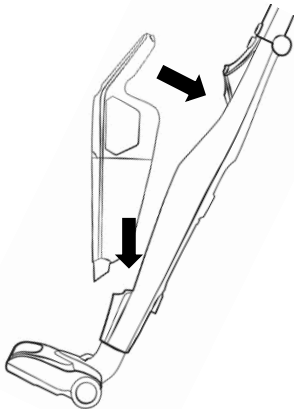

2

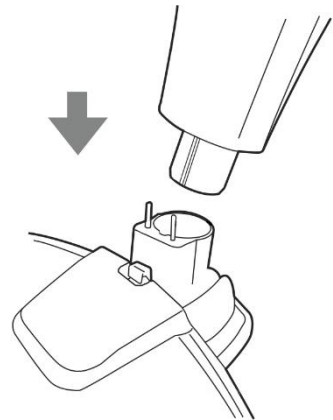

3

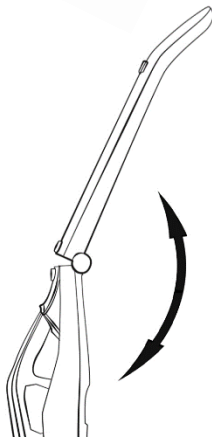

4



# CHARGING YOUR TURBO VAC

**Before using for the first time you will need to charge the cleaner.**

- 1.** First, assemble the charging stand. Before charging ensure the cleaner is switched off.
- 2.** Plug the charging cable into the adaptor socket on the back of the charger dock and insert the plug into a suitable 13 Amp mains socket, pressing the switch on.
- 3.** Lift the assembled cleaner onto the charger dock, ensuring that the lip on the back of the unit clips onto the charging dock and secures correctly.

The charging indicator light on the handheld vacuum will illuminate red, flashing in 2 second intervals to show that the unit is charging.

A full first time charge should be given, of 3-5 hours.

Once charged, the indicator light will illuminate solid red.

**Note:**

- The body may become warm during charging and this is completely normal.
- Make sure the battery is charged when the product will not be used for prolonged periods of time.

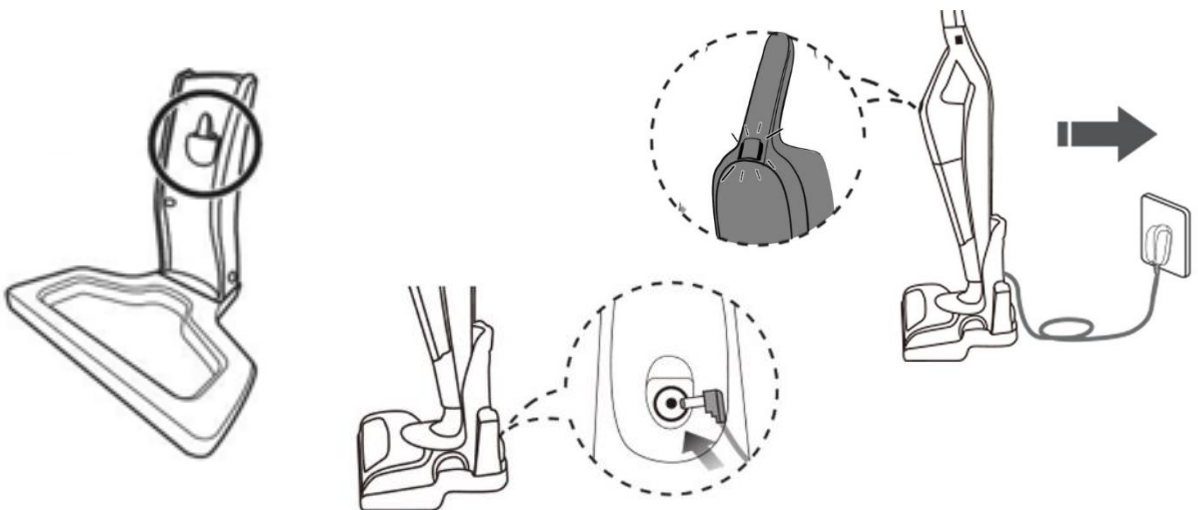

# USING YOUR TURBO VAC

Once assembled and charged:

1. Lift the cleaner off the charging dock and place on the floor.
2. Support the floor head with your foot and pull back the handle
3. Press the main unit power button to start the power.
4. Move the cleaner floor head in a forwards and backwards motion over the areas you would like to clean.

**Note:** Large items can get trapped in the brush/floor head which could cause the unit to overheat. Make sure you pick up larger items that could get trapped before vacuuming.

5. To turn off the power, press the power button.

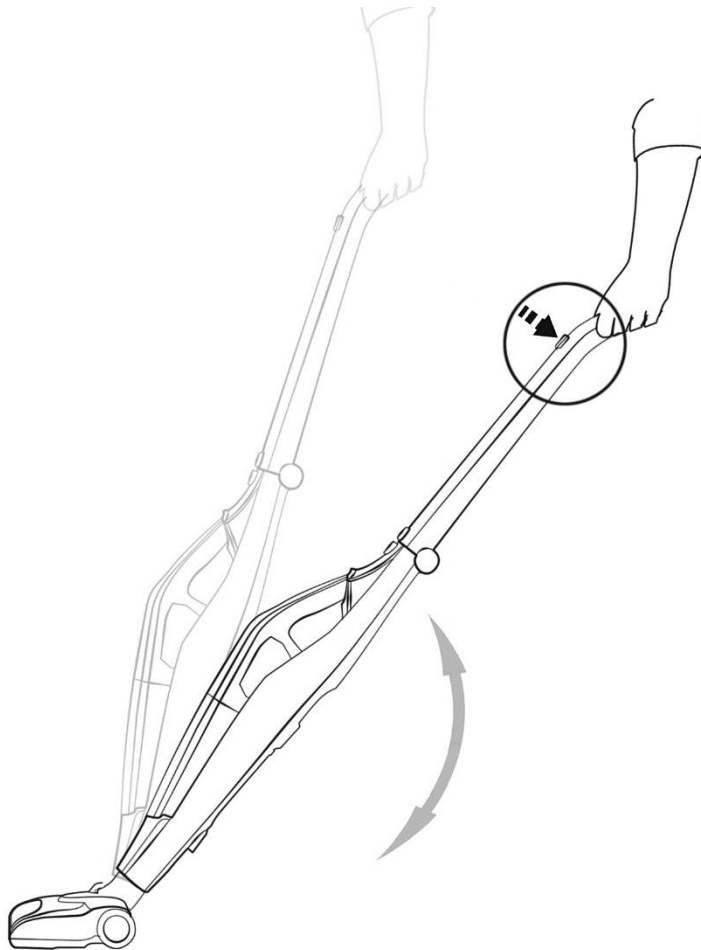

# USING YOUR TURBO VAC - HANDHELD

1. To convert from full sized vac to handheld cleaner, make sure the unit is stood in the upright position and press in the handheld vac release button. Ensure you are holding the handheld unit handle so that it can be pulled out safely.
2. Attach the tool of choice by slotting it into the suction inlet of the handheld unit. To remove the tool, simply pull away from the inlet to slide it out.
  - The crevice tool can be attached for cleaning hard to reach areas, such as sofas, cobwebs and skirting.
  - The brush tool is ideal for cleaning upholstery and stairs.
3. To start cleaning, press the handheld unit power switch.
4. Move the cleaner suction inlet over the areas you would like to clean, avoiding any liquids and large or sharp objects.

1

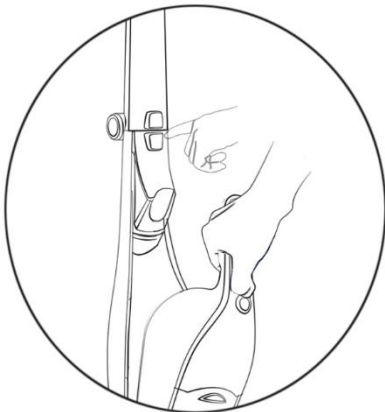

2

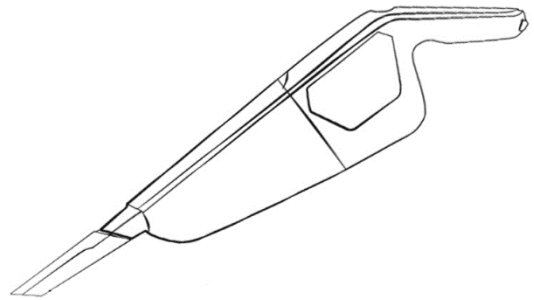

3

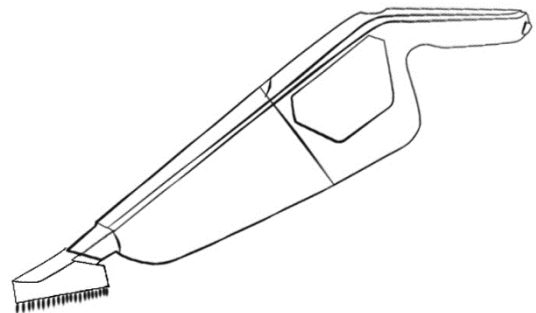
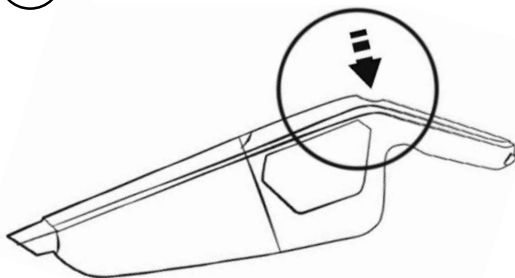

# USING YOUR TURBO VAC

## Emptying the dust container

When the dust container reaches the MAX fill line indicated on the side of the product, it will need to be emptied. This will help it to maintain suction performance.

1. To remove the dust container, press the release button located just above where the container is attached.
2. Pull the dust container away from the unit.
3. Over a bin, remove the whole filter assembly and tap off the trapped dirt. Tip the container upside down to empty the contents. You may need to tap the sides to dispose of all of the dirt.

### **Important:**

You may wish to empty the dust container outdoors as emptying may create a dust cloud.

4. Place the filter back into the dust container in the direction indicated by the diagram.
5. Place the assembled dust container back onto the unit and click into place.

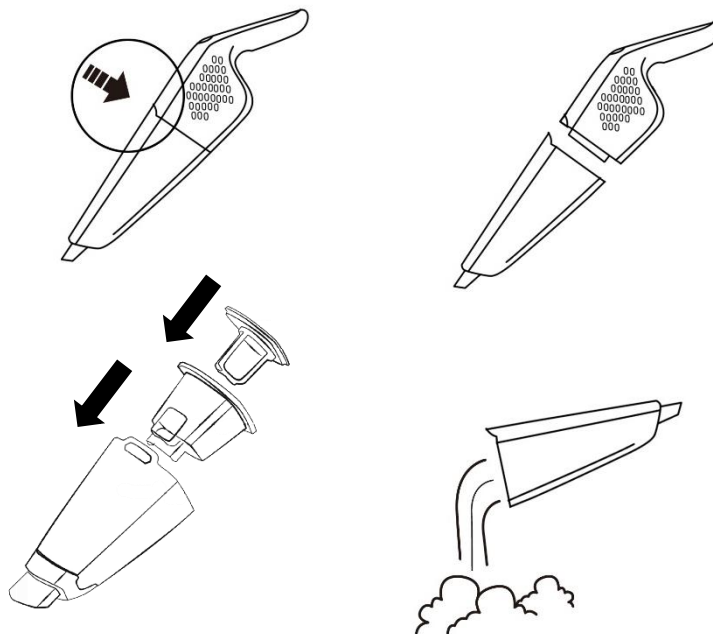

# CLEANING AND CARE:

## CLEANING THE FILTER

It is necessary to clean the filters regularly with frequent use in order to maintain suction performance and prolong the life span of your cleaner.

1. Follow steps 1 to 3 on the previous page.
2. Carefully wash the filter and dust bag in warm water and allow to dry for 24 hours. Also clean the dust container in the same manner.
3. Once dried, place the filter back into the dust container in the direction indicated by the diagram.

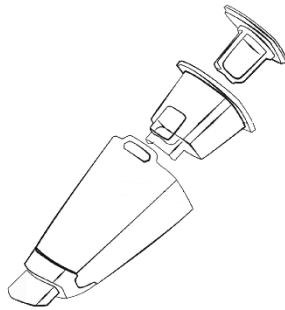

4. Place the assembled dust container back onto the unit, until it clips into place.

After around 6 months of regular use the filters may need replacing. Contact Customer Services using the details provided on page 17.

### **Floor head brush maintenance**

If any threads or hairs get trapped in the brush you may need to carry out maintenance.

For regular maintenance, pull out the waste from around the bar.

If you cannot manually rotate the brush, unscrew the cover and remove the brush to clean it.

When reinserting, make sure the brush cover is securely fixed and that the brush rotates properly.

# CLEANING AND CARE

Before you clean the appliance, make sure the power is switched off and that the unit is not on the charging stand.

It is recommended to store the appliance on the charging stand. Do not leave plugged in for extended periods of time.

You can fold the handle by pressing in the handle release button and folding backwards.

It is not recommended to remove the floor head.

To clean the exterior of the device, use a damp, soft cloth and mild detergent.

## **NEVER IMMERSE THE CLEANER IN WATER.**

Wash non-electrical removable accessories in warm soapy water and allow to dry thoroughly before next use.

If the cleaner is damaged, contact the customer service helpline using the details at the bottom of this page.

### **Storage**

Store in a clean and dry environment.

For Customer Services & Spare Parts please call **0345 209 7461**  
Opening times: Monday - Friday 8am – 8pm & Saturday 9am – 1pm  
Or visit us at **[www.productcare.co.uk](http://www.productcare.co.uk)**



# PROBLEM SOLVING

<b><u>PROBLEM</u></b>	<b><u>POSSIBLE PROBLEM</u></b>	<b><u>POSSIBLE SOLUTION</u></b>
<b><i>The cleaner won't turn on</i></b>	The cleaner hasn't had enough charge	Make sure you have plugged in the cleaner to charge for 3 hours. The light will flash when charging.
	Charging cable is damaged	Make sure there is no signs of damage to the charging cable.
	The power button has not been pressed	Make sure you have turned on the power using either the main unit power button or the handheld power button.
<b><i>The suction is decreasing and the cleaner is not picking up dirt</i></b>	Dust container	Check if the dust container is full, if so, empty it.
	Filters are dirty	Clean the filters. After around 6 months of regular use the filters may need replacing. Contact Customer Services using the details at the bottom of this page.
	Handheld/head blockages	Check that there are no blockages in the handheld suction inlet or cleaning head. If so, clear these blockages.
<b><i>Cleaner is over heating</i></b>	Filters are dirty	Check that the filters are not blocked, if so, clean them following the instructions in this booklet.
<b><i>The charging stand is not working</i></b>	The unit is not fitted correctly on the stand or the stand is not correctly plugged in to the mains	
<b><i>Dust is coming out of the vacuum cleaner</i></b>	Dust container fitting	The dust container has not been fitted correctly. Refit the container following the instructions in this booklet.
<b><i>The air coming out of the vacuum cleaner smells</i></b>	Filters are dirty	Clean the filters and dust container.
	Filters are not dry	Ensure the filters have been left to dry for 24 hours before refitting back into the vacuum cleaner and using.

**We're here should you need us.**

For Customer Services & Spare Parts please call 0345 209 7461  
 Opening times: Monday - Friday 8am – 8pm & Saturday 9am – 1pm  
 Or visit us at [www.productcare.co.uk](http://www.productcare.co.uk)





# **GUARANTEE AND CUSTOMER SERVICES**

At Russell Hobbs, we take all our customer feedback seriously.

**Feel free to contact our Product Care Team, on 0345 209 7461  
Monday – Friday: 8am-8pm & Saturday: 9am – 1pm,  
who will be more than happy to assist you.**

This product is guaranteed for **12 months** from the date of the original purchase. If any defect arises due to faulty materials or workmanship, the faulty product must be returned to the place of purchase.

Refund or replacement is at the discretion of the retailer.

## **The following conditions apply:**

- The product must be returned to the retailer with the original proof of purchase.
- The product must be installed and used in accordance with the instructions contained in this instruction guide and any other instructions for use which are supplied.
- It must be used for domestic purposes only and for its intended use.
- This warranty does not cover wear and tear, damage, misuse or consumable parts.

**This does not affect your statutory rights.**

For Customer Services & Spare Parts please call **0345 209 7461**  
Opening times: Monday - Friday 8am – 8pm & Saturday 9am – 1pm  
Or visit us at **[www.productcare.co.uk](http://www.productcare.co.uk)**

# SPARE PARTS

To check the availability of the following spare parts, simply contact our friendly Customer Services team using the details provided at the bottom of this page.



① Filter

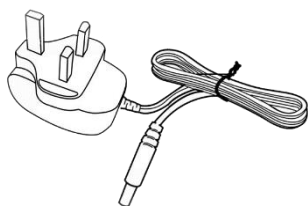

② Charging cable

For Customer Services & Spare Parts please call **0345 209 7461**  
Opening times: Monday - Friday 8am – 8pm & Saturday 9am – 1pm  
Or visit us at [www.productcare.co.uk](http://www.productcare.co.uk)

# NOTES

A large, empty rectangular box with rounded corners and a thin green border, intended for taking notes.





# Russell Hobbs

At the heart of your home

For Customer Services & Spare  
Parts please call

**0345 209 7461**

Opening times: Monday - Friday  
8am – 8pm & Saturday 9am – 1pm

Or visit us at

**[www.productcare.co.uk](http://www.productcare.co.uk)**

Revision 1b

Model: **RHSV1601**

Made by G2S Ltd under license.

G2S Limited, Wigan, WN2 4AY

Russell Hobbs is the registered trademark of  
Spectrum Brands (U.K.) Ltd.

CE



This symbol is known as the 'Crossed-out wheellie bin Symbol'. When this symbol is marked on a product/batteries, it means that the product/batteries should not be disposed of with your general household waste. Only discard electrical/electronic/battery items in separate collection schemes, which cater for the recovery and recycling of materials contained within. Your co-operation is vital to ensure the success of these schemes and for the protection of the environment. For your nearest disposal facility, visit [www.recycle-more.co.uk](http://www.recycle-more.co.uk) or ask in store for details.

We reserve the right, due to possible changes to design, to alter the instruction manual without prior notice.

