

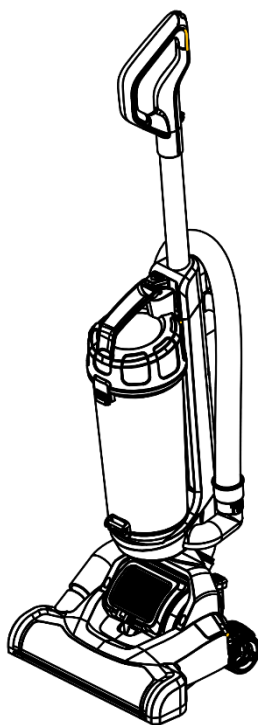

# Russell Hobbs

At the heart of your home

## Compact Cyclonic Bagless Cylinder Vacuum Cleaner



**Model Number: RHUV3002**  
**220-240V~, 50/60Hz, 700W**

For Customer Services & Spare Parts please call **0345 209 7461**  
Opening times: Monday - Friday 8am – 8pm & Saturday 9am – 1pm  
Or visit us at [www.productcare.co.uk](http://www.productcare.co.uk)

**PLEASE RETAIN**  
**FOR FUTURE REFERENCE**

# CONTENTS

	Page(s)
Safety instructions	3-6
Energy performance label	7
Technical data	8
Vacuum feature diagram	9
Vacuum cleaner assembly	10-12
Using your vacuum cleaner	13
Cleaning and care	14-17
Problem solving	18
Guarantee and customer services	19
Spare parts	20
Connection to the mains supply	21
Disposal information	24

Thank you for purchasing your Russell Hobbs Compact Cyclonic Upright Vacuum Cleaner.

To get the best from your new cleaner, take a few moments to read these instructions and keep them in a safe place for future reference.

Should you require any further assistance, our friendly Product Care team will be happy to help.

For Customer Services & Spare Parts please call **0345 209 7461**  
Opening times: Monday - Friday 8am – 8pm & Saturday 9am – 1pm  
Or visit us at **[www.productcare.co.uk](http://www.productcare.co.uk)**



# **SAFETY INSTRUCTIONS**

## **IMPORTANT SAFETY INSTRUCTIONS** **READ CAREFULLY AND KEEP FOR FUTURE REFERENCE**

### **WARNING:**

- It is hazardous for anyone other than a competent person to carry out any service or repair operation that involves the removal of a cover which gives protection against exposure to electrical parts.
- If the supply cord is damaged, it must be replaced by the manufacturer, its service agent or similarly qualified persons in order to avoid a hazard.
- This product is intended for household use only. Do not use outdoors.
- This appliance can be used by children aged from 8 years and above and persons with reduced physical, sensory or mental capabilities or lack of experience and knowledge if they have been given supervision or instruction concerning use of the appliance in a safe way and understand the hazards involved. Children shall not play with the appliance. Cleaning and user maintenance shall not be made by children without supervision.
- Do not operate this appliance for anything other than its intended use. This product is intended for household use only. Do not use outdoors.
- Do not immerse in water or other liquids for cleaning.

# **SAFETY INSTRUCTIONS**

## **IMPORTANT SAFETY INSTRUCTIONS**

### **READ CAREFULLY AND KEEP FOR FUTURE REFERENCE**

- Do not direct at people, animals, electrical outlets, or equipment containing electrical components.
- Unplug from outlet when not in use. Do not leave the cleaner unattended while plugged in.
- Do not use with damaged cord or plug.
- Do not use vacuum cleaner if it has been dropped, damaged, left outdoors or dropped into water.
- Keep the vacuum cleaner away from water; do not allow it to get wet. If unit is wet, do not plug unit into wall socket or turn unit on.
- Do not handle the vacuum cleaner with wet hands.
- Do not pull or carry by cord, use cord as a handle, close door on cord, pull cord around sharp corners or edges, or expose cord to heated surfaces.
- Do not unplug by pulling on cord.
- To protect against electrical shock do not immerse cord, plug, or appliance in water or other liquid.
- Unplug from the mains outlet when not in use, before putting on and taking off parts, and before cleaning.
- The use of accessory attachments not recommended by the appliance manufacturer may cause fire, electric shock or injury. Only use the accessories supplied by the manufacturer.



# **SAFETY INSTRUCTIONS**

## **IMPORTANT SAFETY INSTRUCTIONS** **READ CAREFULLY AND KEEP FOR FUTURE REFERENCE**

### **WARNING:**

- Do not let the cord hang over the edge of the worktop, or touch hot surfaces.
- Do not use this vacuum to pick up water or any other liquids, combustible substances or hot/burning objects.
- Only use the unit when fully assembled.
- Never place your fingers or other objects into any part of the cleaner. Be aware that loose clothing or hair may become trapped in the cleaner if improperly used.
- Before use, ensure that all of the air vents of the cleaner are clear and there is no restriction of air flow.
- This vacuum cleaner is fitted with a constantly rotating brush bar. To avoid damage to your flooring, make sure the brush bar is raised to the highest setting when using the accessories or hose.
- Caution: Exhaust air discharged from the rear of the cleaner may extinguish a gas fire, pilot light, or disturb ashes in an open fire. Always avoid directing the cleaner toward naked flames.

# SAFETY INSTRUCTIONS

## **IMPORTANT SAFETY INSTRUCTIONS** **READ CAREFULLY AND KEEP FOR FUTURE REFERENCE**

- When cleaning stairs to prevent the vacuum cleaner falling always place the vacuum cleaner at the bottom of stairs on the floor. Do not place the vacuum cleaner on stairs or furniture.
- When cleaning stairs with the hose and attachments, ensure the brush bar is raised to the highest setting.
- **Important:** This cleaner has a thermal safety device which automatically cuts off the power supply in case of over heating. If the safety device has switched the cleaner off, unplug from the mains, allow the cleaner to cool down and check for any blockages. Once the cleaner has cooled it can be plugged back in to the mains and used as normal.

For Customer Services & Spare Parts please call **0345 209 7461**  
Opening times: Monday - Friday 8am – 8pm & Saturday 9am – 1pm  
Or visit us at **[www.productcare.co.uk](http://www.productcare.co.uk)**



# ENERGY PERFORMANCE LABEL

The purpose of the energy label is to help you understand a vacuum cleaner's energy efficiency performance.

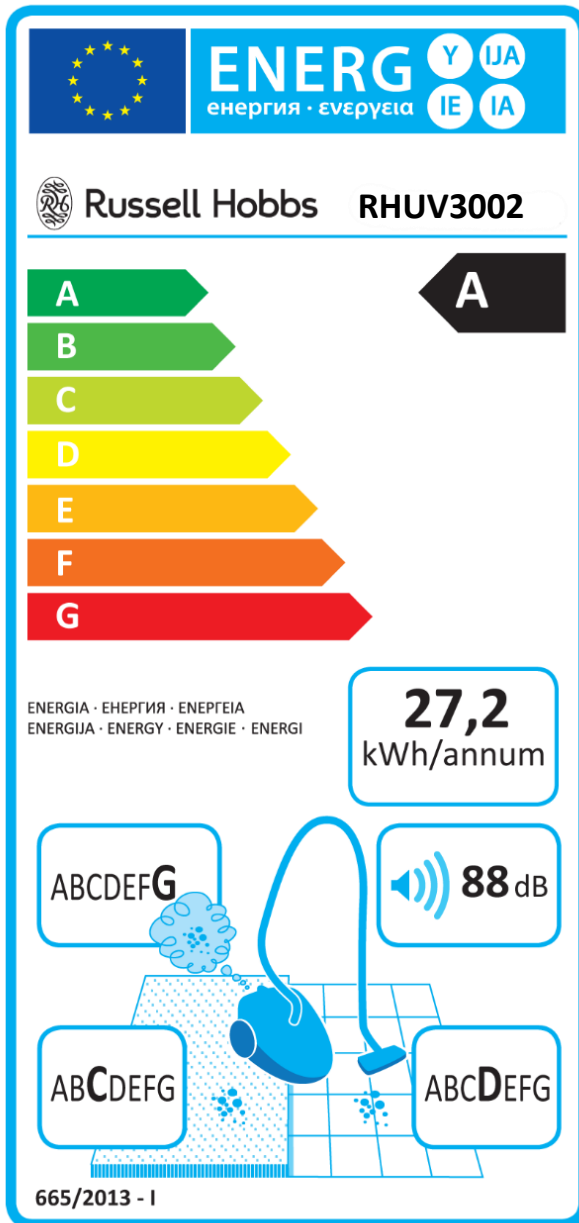

**1. Energy rating** – based primarily on energy consumption and pick-up.

**2. Annual energy usage** – the amount of energy used over a year.

**3. Emissions** – the amount of dust in the air emitted from the machine's exhaust.

**4. Noise** – the noise level produced by the machine, measured in decibels.

**5. Pick up (carpets)** – the rating of how much dust the machine picks up from carpets.

**6. Pick-up (hard floors/crevices)** – the rating of how much dust the machine picks up from hard floors and crevices.

# TECHNICAL DATA (PRODUCT FICHE)

Trade mark	Russell Hobbs
Model	RHUV3002
Energy efficiency class	A
Annual energy consumption (kWh/year)	27.2
Carpet cleaning performance class	C
Hard floor cleaning performance class	D
Dust re-emission class	G
Sound power level	88
Rated input power	700W





# VACUUM FEATURE DIAGRAM

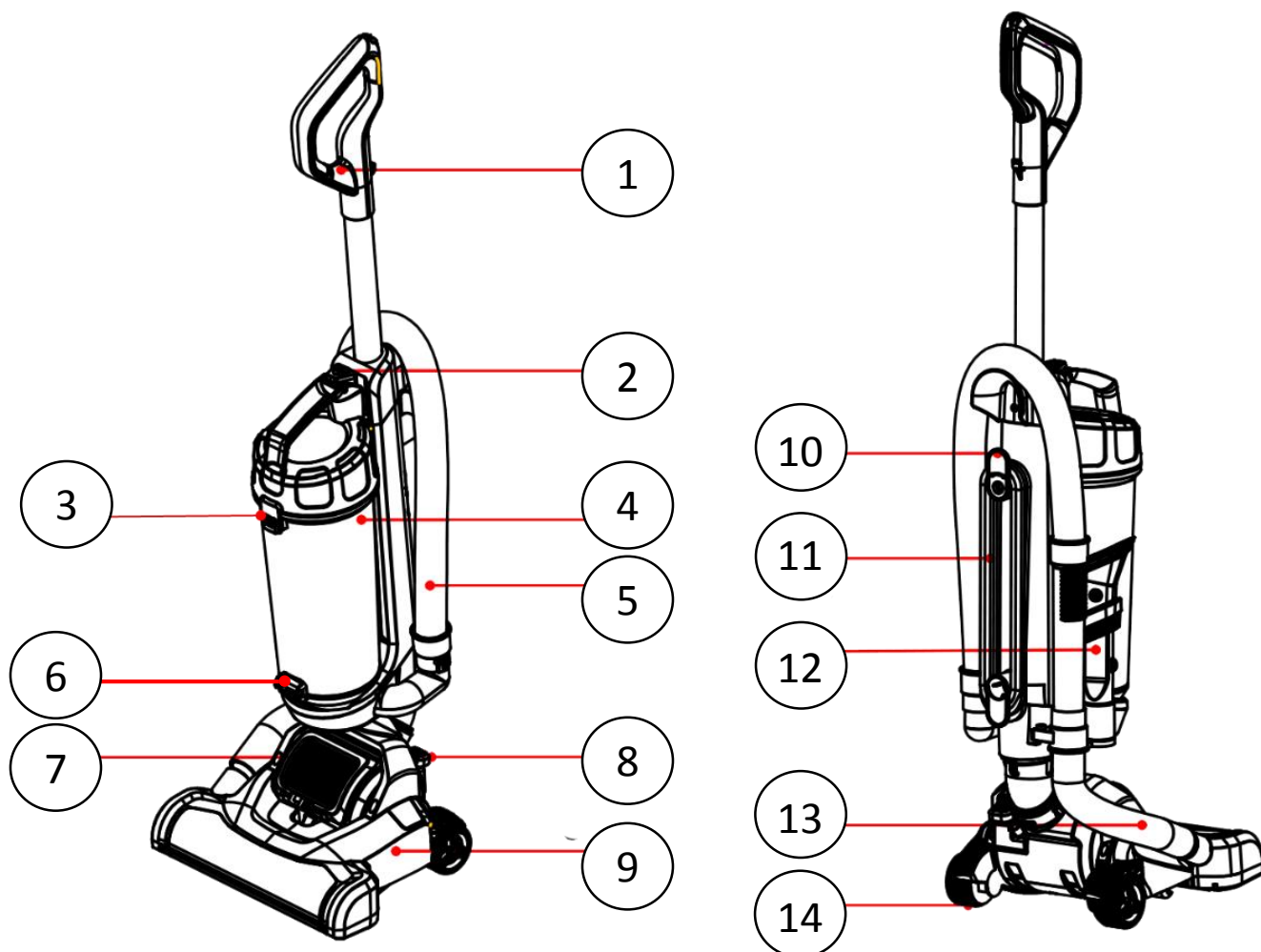

- 1. Handle
- 2. Dust container release button
- 3. Dust container lid release clip
- 4. Dust container
- 5. Hose
- 6. Dust container bin release clip
- 7. Floor head filter

- 8. Power button
- 9. Floor head
- 10. Quick cord release
- 11. Power cord
- 12. 3 in 1 crevice tool
- 13. Brush hose
- 14. Wheel

# VACUUM CLEANER ASSEMBLY

## **Before using your vacuum cleaner**

Remove all packaging and lay out the separate components.

Check the unit after unpacking for any visual damage such as:

- Misaligned or damaged parts
- Damage to the main body and separate components
- Damage to the plug or cable.

If you can see any damage do not use the vacuum cleaner and contact customer services.

For Customer Services & Spare Parts please call **0345 209 7461**  
Opening times: Monday - Friday 8am – 8pm & Saturday 9am – 1pm  
Or visit us at **[www.productcare.co.uk](http://www.productcare.co.uk)**



# VACUUM CLEANER ASSEMBLY

**Ensure the unit is unplugged before assembling.**

Locate the screw that comes in the box with your product.

**1.** Lower the handle onto the main body of the vacuum and press down.

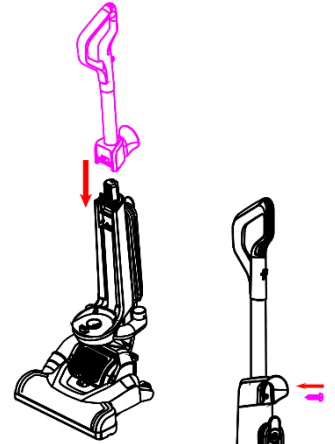

**2.** Place the screw in the hole and tighten with a Philips screw driver.

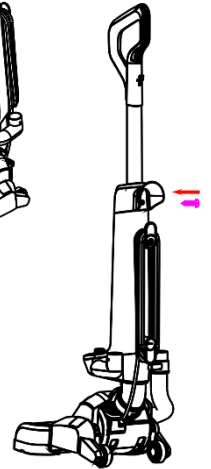

**3.** Place the dust container onto the unit, base first, then tilt forward to engage the top.

**Note:** Do not carry the unit with the dust container.

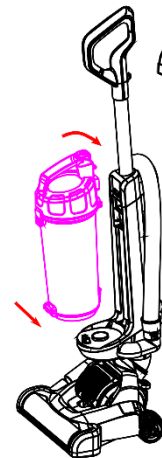

**4.** The hose wraps over the hook on the back of the unit. The head of the hose is placed into the brush hose inlet.

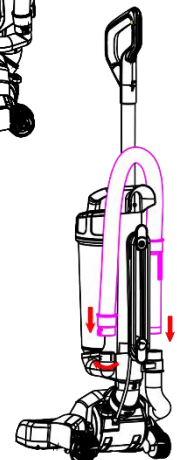

# VACUUM CLEANER ASSEMBLY

**5.** The combination crevice tool is stored on the vacuum cleaner, located above the brush hose inlet. The base of the tool slides onto the stand as per the diagram.

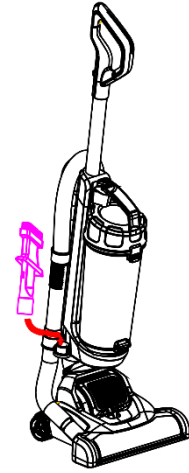

**6.** When using the hose to clean areas other than the floor, lift the hose from the brush hose inlet.

To attach the crevice tool for narrow, hard to reach places, remove the hose from the end of the brush hose inlet and slot the crevice tool into place.

To attach the brush for more delicate surfaces, slot the attachment onto the crevice tool until the clip on the side secures into place.

To remove the brush attachment, press in the clip on the side and pull away.

For extra pick up of hair and lint on fabrics and stairs, slot on the upholstery attachment so that the red fabric is positioned for pick-up. Again, the clip on the side secures the attachment in place.

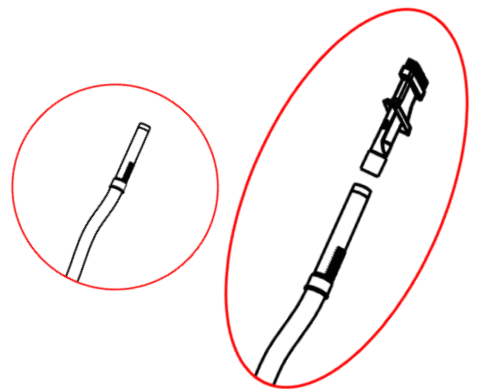
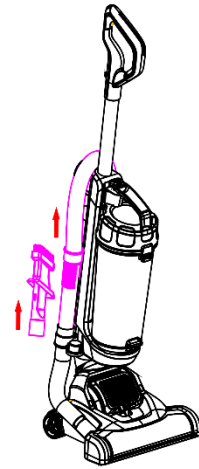

# USING YOUR VACUUM CLEANER

Once the vacuum cleaner is assembled and ready for use:

1. Twist the quick cord release.
2. Plug the cable into a wall socket and press the switch on.

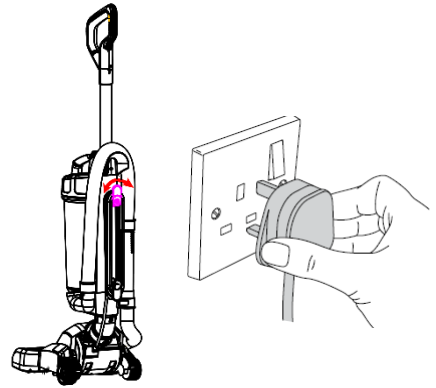

3. Rest your foot on the vacuum head and pull the handle back towards yourself.
4. Press the power button gently with your foot to begin vacuuming.

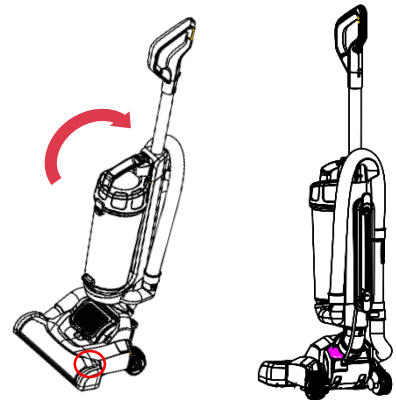

5. Move the vacuum cleaner in a forwards and backwards motion over the areas you would like to clean.

**Note:** Large items can get trapped in the brush and cause the bar to stop rotating, which could cause the unit to overheat. Make sure you pick up larger items that may get trapped before vacuuming.

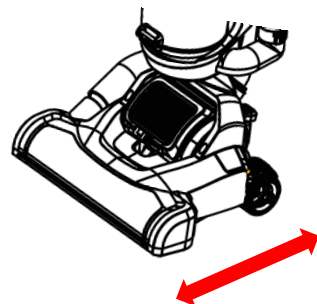

**Note:** You can use the clip at the back of the handle to hook the cable and move it out of your way when vacuuming.

# CLEANING AND CARE: EMPTYING THE DUST CONTAINER

When the dust container reaches the 'MAX' line fill, it will need to be emptied.

1. To remove the dust container, press the release button on the head and pull away/upwards from the unit

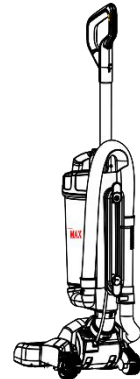

2. Release the base carefully over a bin by pulling the tab away and downwards. You may need to tap the sides to empty all of the dirt. Close the base to secure.

**Important:**

You may wish to empty the dust container outdoors as emptying could create a dust cloud.

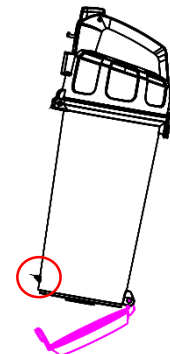
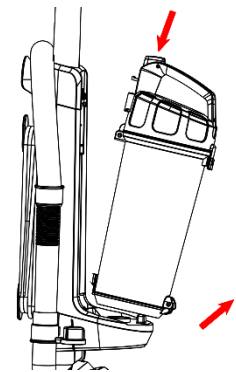

3. Place the dust container onto the unit, base first, then tilt forward to engage the top.

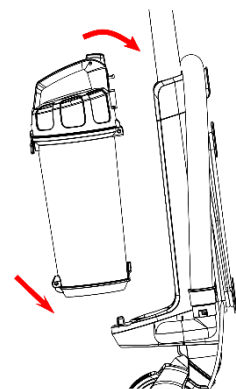

# CLEANING AND CARE: CLEANING THE FILTER

**With frequent use you need to clean the filters in order to maintain peak performance and lengthen product life span.**

To remove the dust container, press the release button on the lid handle and pull away/upwards from the unit.

**1.** Open the lid of the container by pulling the tab on the front in an outwards/upwards motion.

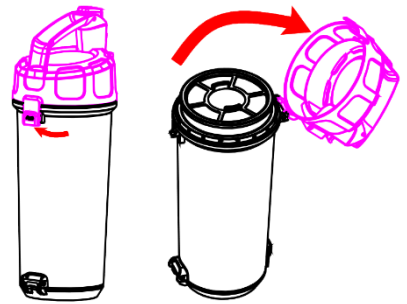

**2.** Once you have lifted off the lid, pull out the filter as per the diagram and separate the foam from the plastic.

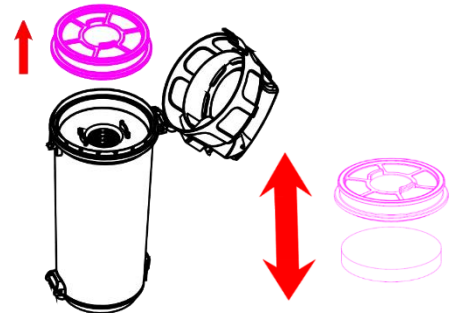

**3.** Both parts of the filter need to be washed. Dust off the filter over the bin by tapping/using a brush. Run both parts of the filter under the tap to clean.

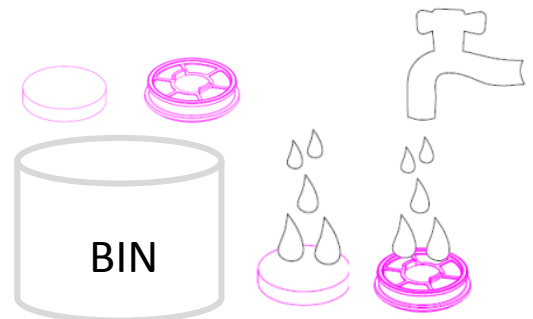

**4.** Leave to fully dry for at least 24 hours before placing back in the container.

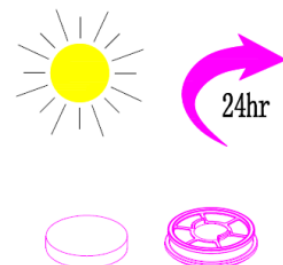

The black foam filter slots back into the plastic, with the foam facing downwards. Put the assembled filter back into the dust container with the plastic side facing upwards and close the lid. It will 'click' and secure.

# CLEANING AND CARE: CLEANING THE FILTER

Repeat steps 1 and 2 on the previous page.

3. Lift out the cone filter.

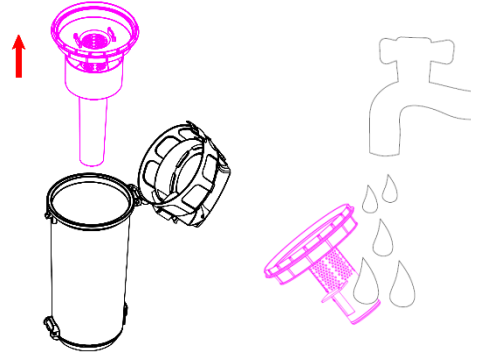

4. Rinse the cone filter under the tap.

5. Leave to fully dry for at least 24 hours before placing back in the container.

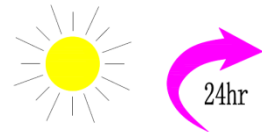

To place back into the container, lower inside the dust canister. Put the assembled filter back into the dust container with the plastic side facing upwards and close the lid.

It will 'click' and secure.



## **Cleaning the exhaust filter**

There is a foam exhaust filter in the vacuum floor head that will need to be cleaned regularly.

To remove the cover, push the clip left to unlock.

Remove the foam filter and follow the cleaning instructions on the previous page.

Ensure you have allowed the filter to thoroughly dry and place back into the cover.

Slot the assembled cover back onto the head and slide the clip right to the 'LOCK' position.



# CLEANING AND CARE

Before you clean the appliance, disconnect the mains plug from the wall socket.

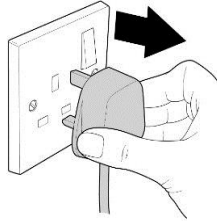

To clean the exterior of the device, use a damp, soft cloth and mild detergent.

**NEVER IMMERSE THE VACUUM IN WATER.**

Wash non-electrical removable accessories in warm soapy water and allow to dry thoroughly before next use.

If the vacuum is damaged, contact the customer service helpline using the details at the bottom of this page.

For Customer Services & Spare Parts please call **0345 209 7461**  
Opening times: Monday - Friday 8am – 8pm & Saturday 9am – 1pm  
Or visit us at **[www.productcare.co.uk](http://www.productcare.co.uk)**



# PROBLEM SOLVING

<b><u>PROBLEM</u></b>	<b><u>POSSIBLE PROBLEM</u></b>	<b><u>POSSIBLE SOLUTION</u></b>
<b><i>The vacuum cleaner is plugged in but does not work</i></b>	Power cord/plug damage	Check the power cord and plug for signs of damage.
	Fuse is damaged	Check and replace the fuse in the plug.
<b><i>The suction is decreasing and the vacuum is not picking up dirt</i></b>	Dust container	Check if the dust container is full, if so, empty it.
	Filters are dirty	Clean the filters.
	Hose/head blockages	Check that there are no blockages in the hose or cleaning head.
<b><i>Vacuum cleaner is over heating</i></b>	Filters are dirty	Check that the filters are not blocked, if so, clean them following the instructions in this booklet.
<b><i>Dust is coming out of the vacuum cleaner</i></b>	Dust container fitting	The dust container has not been fitted correctly. Refit the container following the instructions in this booklet.
<b><i>The air coming out of the vacuum cleaner smells</i></b>	Filters are dirty	Clean the filters. Also clean the hose and dust container.
	Filters are not dry	Ensure the filters have been left to dry for 24 hours before refitting back into the vacuum cleaner and using.

**We're here should you need us.**

For Customer Services & Spare Parts please call 0345 209 7461  
 Opening times: Monday - Friday 8am – 8pm & Saturday 9am – 1pm  
 Or visit us at [www.productcare.co.uk](http://www.productcare.co.uk)



# **GUARANTEE AND CUSTOMER SERVICES**

At Russell Hobbs, we take all our customer feedback seriously.

**Feel free to contact our Product Care Team, on 0345 209 7461  
Monday – Friday: 8am-8pm & Saturday: 9am – 1pm,  
who will be more than happy to assist you.**

This product is guaranteed for **12 months** from the date of the original purchase. If any defect arises due to faulty materials or workmanship, the faulty product must be returned to the place of purchase.

Refund or replacement is at the discretion of the retailer.

## **The following conditions apply:**

- The product must be returned to the retailer with the original proof of purchase.
- The product must be installed and used in accordance with the instructions contained in this instruction guide and any other instructions for use which are supplied.
- It must be used for domestic purposes only and for its intended use.
- This warranty does not cover wear and tear, damage, misuse or consumable parts.

## **This does not affect your statutory rights.**

For Customer Services & Spare Parts please call **0345 209 7461**  
Opening times: Monday - Friday 8am – 8pm & Saturday 9am – 1pm  
Or visit us at **[www.productcare.co.uk](http://www.productcare.co.uk)**

# SPARE PARTS

To check the availability of the following spare parts, simply contact our friendly Customer Services team using the details provided at the bottom of this page.

Lid Filter

Floor Head Filter

3 in1 Crevice Tool

For Customer Services & Spare Parts please call **0345 209 7461**  
Opening times: Monday - Friday 8am – 8pm & Saturday 9am – 1pm  
Or visit us at **[www.productcare.co.uk](http://www.productcare.co.uk)**



# CONNECTION TO THE MAINS SUPPLY

This appliance is designed to operate from a mains supply of  
220-240V~ 50/60Hz.

Check that the voltage marked on the product corresponds  
with your supply voltage.

## How to change the fuse

1. Slot the end of a screwdriver into the recess in the fuse holder of the plug.
2. Pull the fuse holder upwards until free of the plug and slide the fuse out.
3. Replace the fuse and replace fuse holder, pushing down until locked into place.

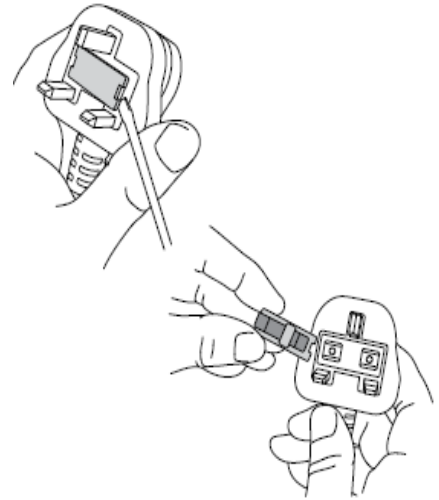

**Important:** Only ever use 13 amp fuses.

For Customer Services & Spare Parts please call **0345 209 7461**  
Opening times: Monday - Friday 8am – 8pm & Saturday 9am – 1pm  
Or visit us at [www.productcare.co.uk](http://www.productcare.co.uk)

# NOTES

# NOTES

A large, empty rectangular box with rounded corners and a thin green border, intended for taking notes.





# Russell Hobbs

At the heart of your home

For Customer Services & Spare  
Parts please call  
**0345 209 7461**

Opening times: Monday - Friday  
8am – 8pm & Saturday 9am – 1pm

Or visit us at  
**[www.productcare.co.uk](http://www.productcare.co.uk)**

Revision 5

Model: **RHUV3002**

Made by G2S Ltd under license.  
G2S Limited, Wigan, WN2 4AY



This symbol is known as the 'Crossed-out wheellie bin Symbol'. When this symbol is marked on a product/batteries, it means that the product/batteries should not be disposed of with your general household waste. Only discard electrical/electronic/battery items in separate collection schemes, which cater for the recovery and recycling of materials contained within. Your co-operation is vital to ensure the success of these schemes and for the protection of the environment. For your nearest disposal facility, visit [www.recycle-more.co.uk](http://www.recycle-more.co.uk) or ask in store for details.

We reserve the right, due to possible changes to design, to alter the instruction manual without prior notice.

