

SCHR Eden Oak Veneer Table 180cm

Assembly Instructions - Please keep for future reference

603/3600

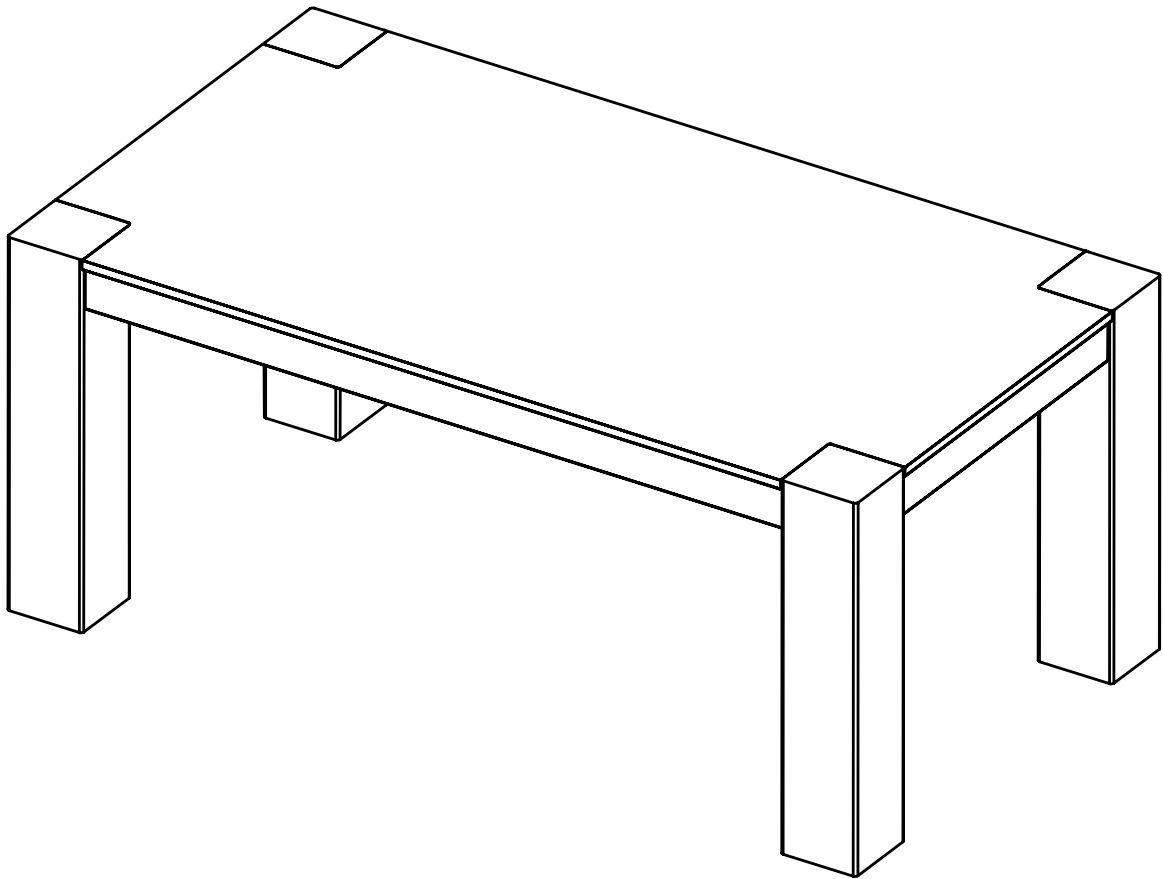

Dimensions

Width - 180cm

Depth - 100cm

Height - 76cm

Important – Please read these instructions fully before starting assembly

If you need help or have damaged or missing parts, call the **Customer Helpline: 0845 640 0800**



Safety and Care Advice

Important – Please read these instructions fully before starting assembly

- Check you have all the components and tools listed on pages 2 and 3.
- Remove all fittings from the plastic bags and separate them into their groups.
- Keep children and animals away from the work area, small parts could choke if swallowed.
- Make sure you have enough space to layout the parts before starting.

- Do not stand or put weight on the product, this could cause damage.
- Assemble the item as close to its final position (in the same room) as possible.
- Assemble on a soft level surface to avoid damaging the unit or your floor.
- Parts of the assembly will be easier with 2 people.



- We do not recommend the use of power drill/drivers **for inserting screws**, as this could damage the unit. Only use hand screwdrivers.
- Dispose of all packaging carefully and responsibly.

Care and maintenance

- Only clean using a damp cloth and mild detergent, do not use bleach or abrasive cleaners.
- From time to time check that there are no loose screws on this unit.
- This product should not be discarded with household waste. Take to your local authority waste disposal centre.

Components - Panels

If you have damaged or missing components, call the **Customer Helpline: 0845 640 0800**

Please check you have all the panels listed below

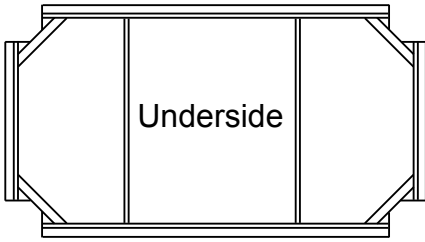

1 Top (180 x 100cm)





2 Leg x 4 (76 x 16cm)

Components - Fittings

Please check you have all the fittings listed below

Note: The quantities below are the correct amount to complete the assembly. In some cases more fittings may be supplied than are required.

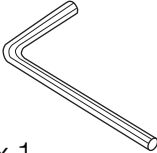
<p>A </p> <p>Bolt x 8 (M8 x 64mm)</p>	<p>B </p> <p>Flat washer x 8</p>	<p>C </p> <p>Spring washer x 8</p>
<p>D </p> <p>Hex key x 1</p>		

Tools required

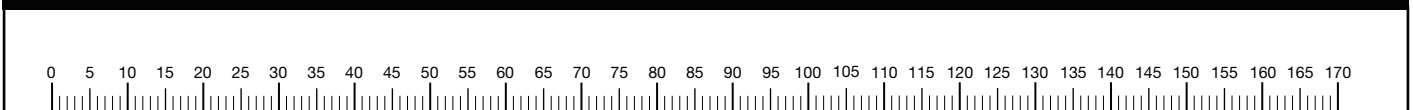

Ruler - Use this ruler to help correctly identify the screws









Assembly Instructions

Step 1

Attaching legs

Match the legs and table top corners by the symbols  & .

Attach four legs  to top  using washer  spring washer  and bolt . Tighten the bolts with hex key .

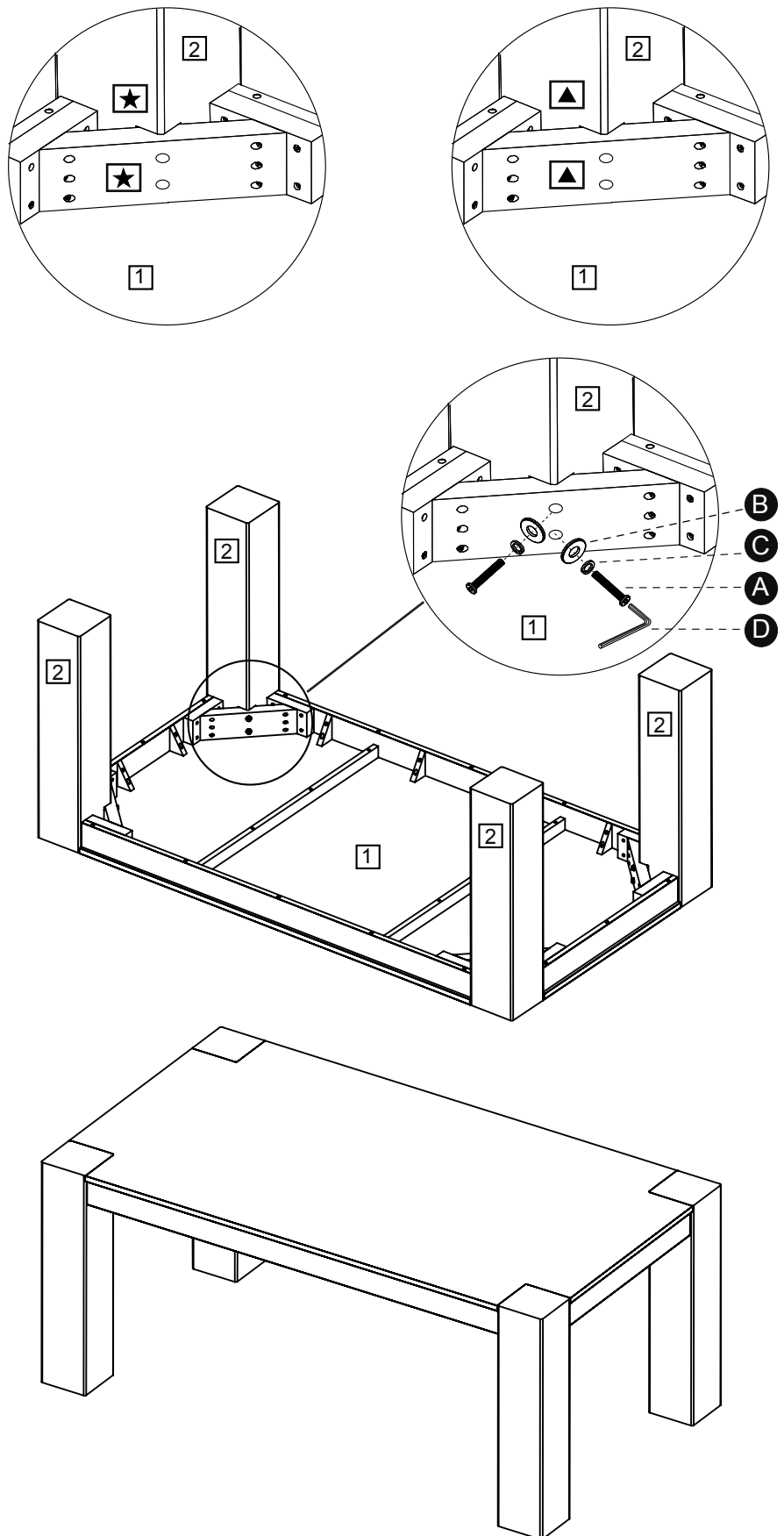

Step 2

Turn the table over carefully.

Assembly is complete.

If you need help or have damaged or missing parts, call the **Customer Helpline: 0845 640 0800**
Argos Ltd MK9 2NW

Warwick Chair

Assembly Instructions - Please keep for future reference

6038447

6037819

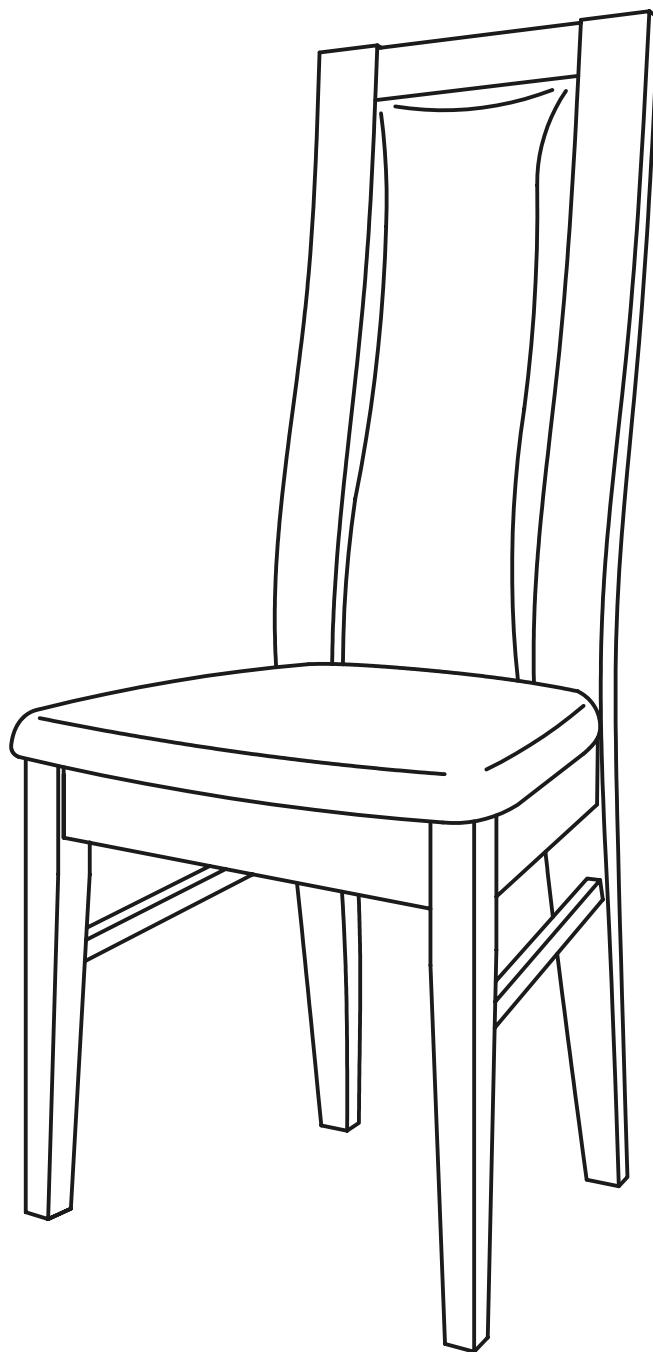

Dimensions

Width - 46.5cm

Depth - 54cm

Height - 99cm

Important - Please read these instructions fully before starting assembly

If you need help or have damaged or missing parts, call the Customer Helpline : 08456 400800



Safety and Care Advice

Important - Please read these instructions fully before starting assembly

- Check you have all the components and tools listed on page 2 and 3.

- Remove all fittings from the plastic bags and separate them into their groups.

- Keep children and animals away from the work area, small parts could choke if swallowed.

- Make sure you have enough space to layout the parts before starting.

- Do not stand or put weight on the product, this could cause damage.

- Assemble the item as close to its final position (in the same room) as possible.

- Assemble on a soft level surface to avoid damaging the unit or your floor.

- Parts of the assembly will be easier with 2 people.



- We do not recommend the use of power drill/drivers **for inserting screws,**

as this could damage the unit. Only use hand screwdrivers.

- Dispose of all packaging carefully and responsibly.

- The maximum safe weight of user : 110 Kgs.

Care and maintenance

- Only clean using a damp cloth and mild detergent, do not use bleach or abrasive cleaners.

- From time to time check that there are no loose screws on this unit.

- This product should not be discarded with household waste. Take to your local authority waste disposal centre.

Note: if required the next page can be cut out and used as reference throughout the assembly. Keep this page with these instructions for future reference.

Components - Panels

If you have damaged or missing components, call the Customer Helpline: 08456 400800

Please check you have all the panels listed below

NOTE: Components, listed below are required for one chair only.

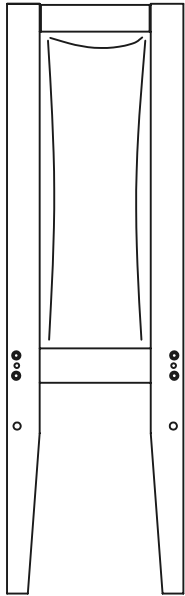

1 Backrest x 1
(29.6 x 99cm)

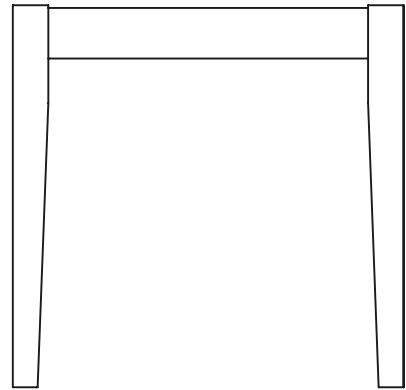

2 Front Leg x 1
(43 x 43cm)



3 Right Side Stretcher x 1
(36 x 5.8cm)



4 Left Side Stretcher x 1
(36 x 5.8cm)

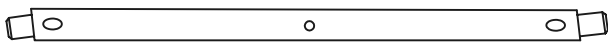

5 Right Side Rail x 1
(39.8 x 2.2cm)

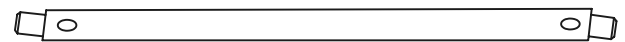

6 Left Side Rail x 1
(39.8 x 2.2cm)

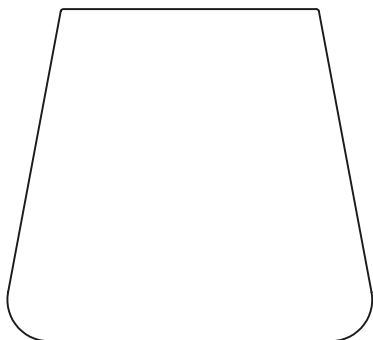





7 Seat Cushion x 1
(46.5 x 40cm)



Components - Fittings

Please check you have all the fittings listed below

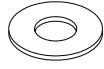
Note: The quantities below are the correct amount to complete the assembly for one chair. In some cases more fittings may be supplied than are required.

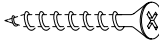
<p>A </p> <p>50mm Screw x 6</p>	<p>B </p> <p>Spring Washer M6 x 6</p>	<p>C </p> <p>Flat Washer M6 x 6</p>
<p>D </p> <p>M 4 Allen Key x 1</p>	<p>E </p> <p>32mm Screw x 8</p>	

Tools required

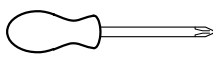

Phillips screwdriver
(medium & large)

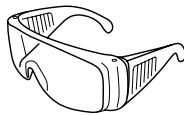

Eye protection
(when using a
hammer or glue)



Small
hammer

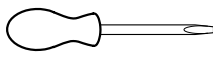

Flatblade screwdriver
(medium)

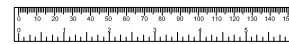

Ruler/tape
measure

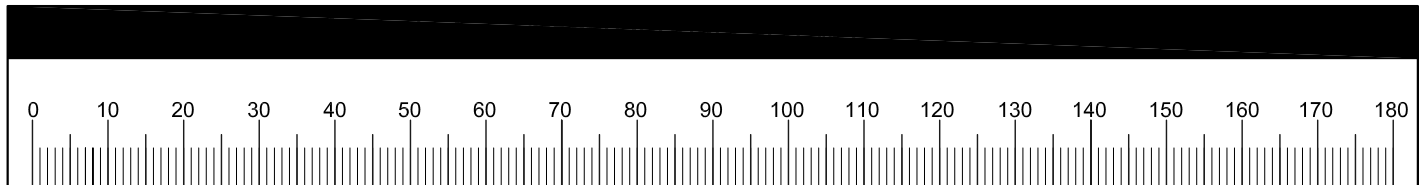

Assembly Instructions

Step 1

Fitting the Side Stretcher

Note: It would be useful to ask someone to help you at this stage.

a: Insert Screw **A**, Spring washer **B**, Flat washer **C** with Allen key **D** to fix side stretcher **3** **4** onto backrest. **1**

Note: Do not fully tighten all the screws

Fitting the Side Rail

Note: It would be useful to ask someone to help you at this stage.

b: Insert Screw **E** to fix side rail **5** **6** onto back rest **1**

Note: Do not fully tighten all the screws

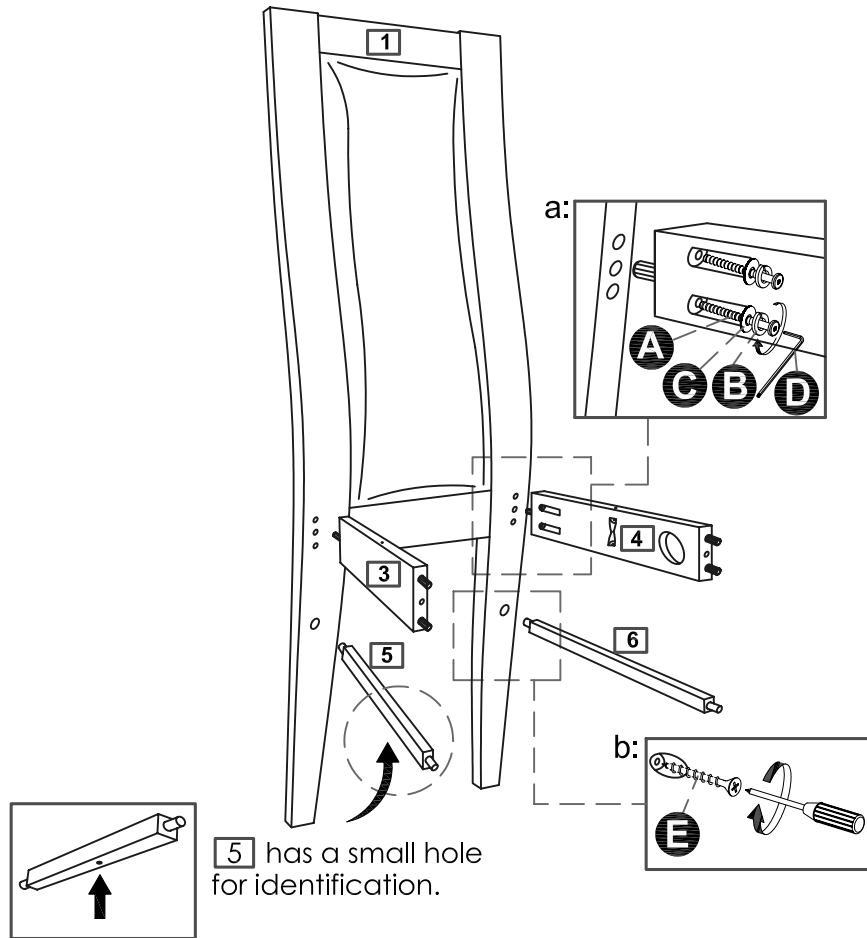

Step 2

Fitting the Front Leg

Note: It would be useful to ask someone to help you at this stage.

c: Insert Screw **A**, Spring washer **B**, Flat washer **C** with Allen key **D** to fix front leg **2** onto side stretcher **3** **4**

d: Insert Screw **E** to fix side rail **5** **6** onto front leg **2**

Note: Do not fully tighten all the screws

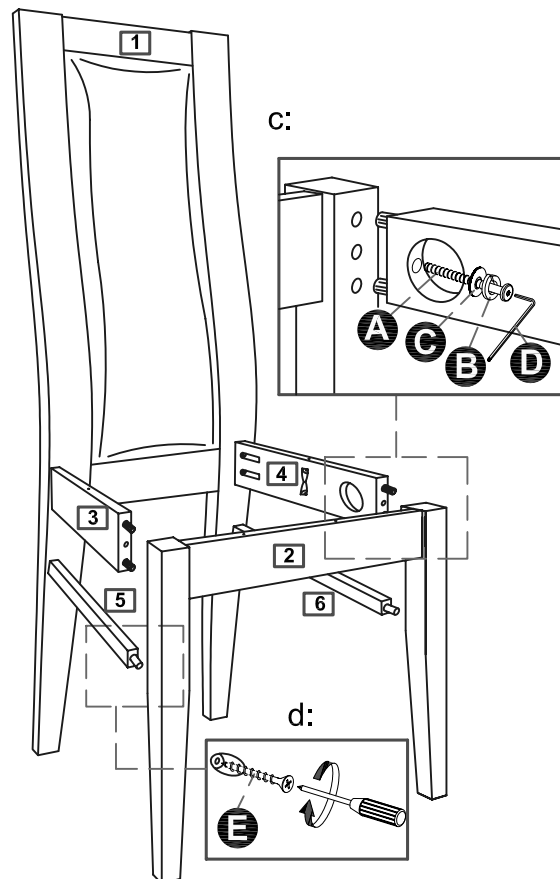

Assembly Instructions

Step 3

Fitting the Cushion

Note: It would be useful to ask someone to help you at this stage.

e: Use Screw **E** to fix cushion seat **7** onto the unit.

Note: Fully tighten all the screws now.

e:

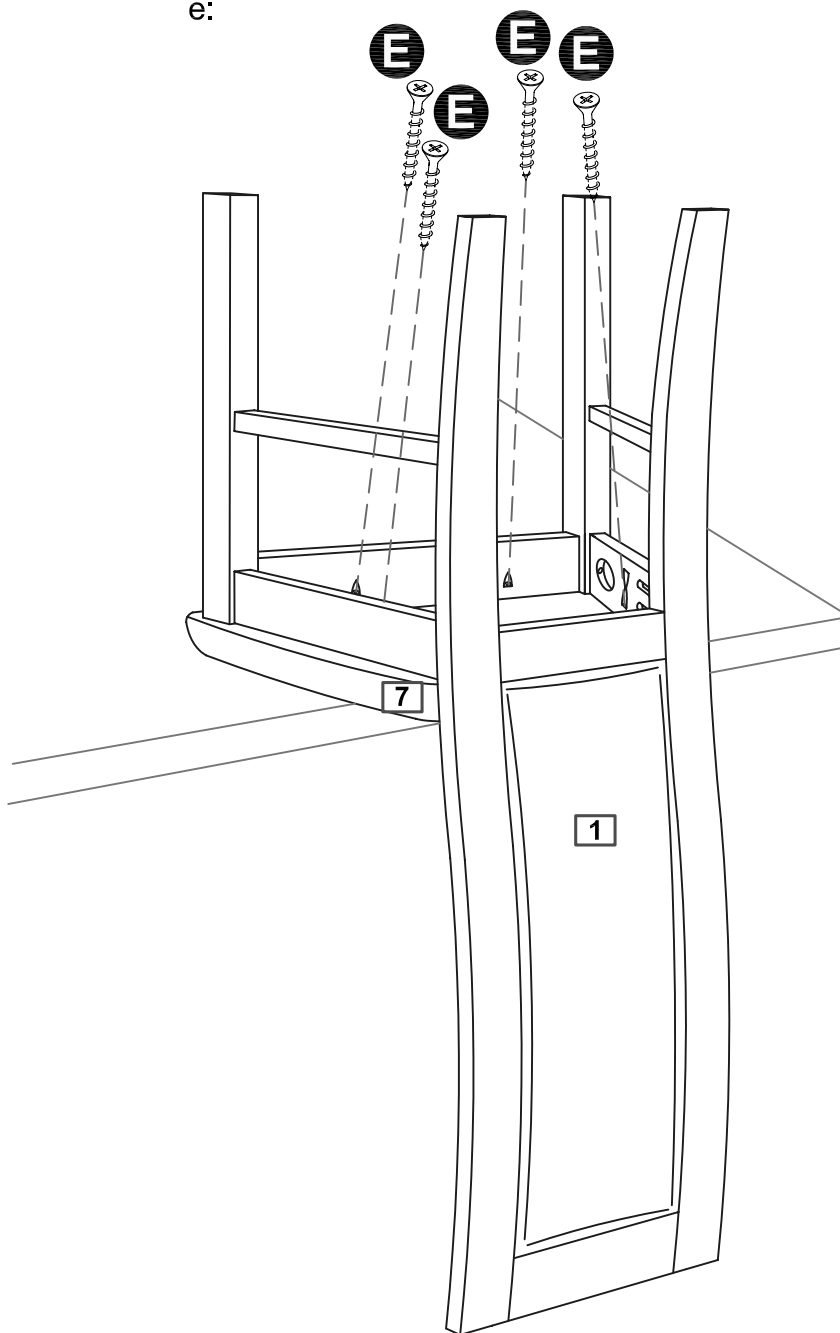

Assembly Instructions

Step 4

Finishing the unit

Note: It would be useful to ask someone to help you at this stage.

With help, place the unit in the intended position.

Note: Before use always make sure the unit is secure.

Note: The maximum safe weight of user: 110kg.



Warning:

- Do not stand on this chair. Do not use this chair as a step ladder.
- Use this product only for seating one person at a time.
- Do not use this chair unless all bolts, screws and knobs are firmly secured.
- At least every 4 months, check all bolts, screws and knobs, to be sure they are tight.
- If parts are missing, broken or damaged or worn, stop use of this product until repairs are made & using factory authorized parts.
- Failure to follow these warnings could result in serious injury.

Assembly is complete.

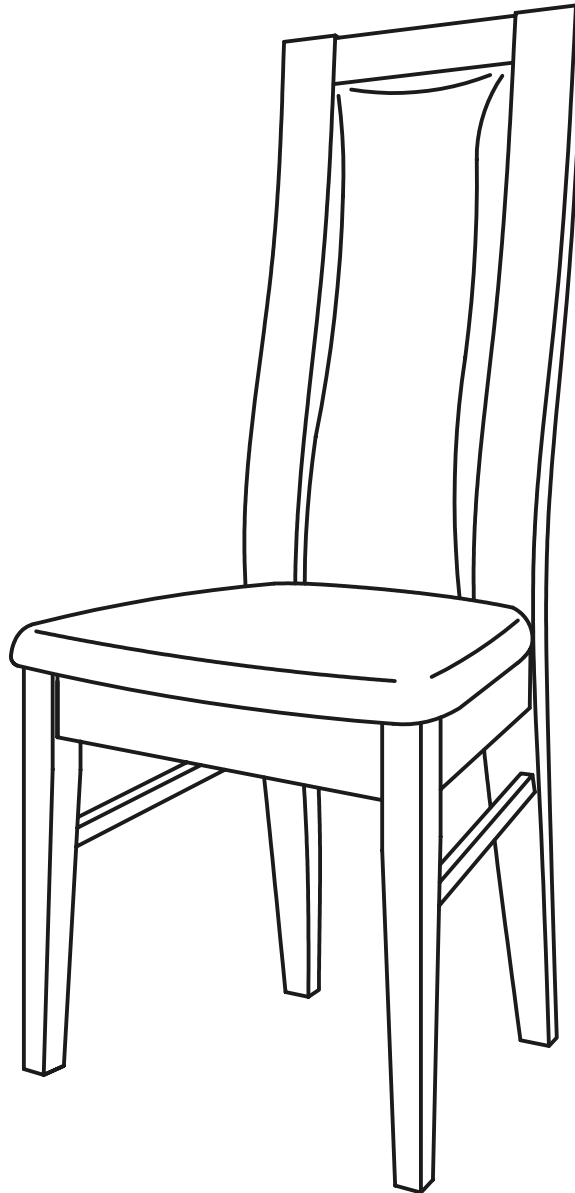

If you need help or have damaged or missing parts, call the **Customer Helpline: 08456 400800**