

# Baltimore Scroll-Back Chair

Assembly Instructions - Please keep for future reference

603/0115

603/0122

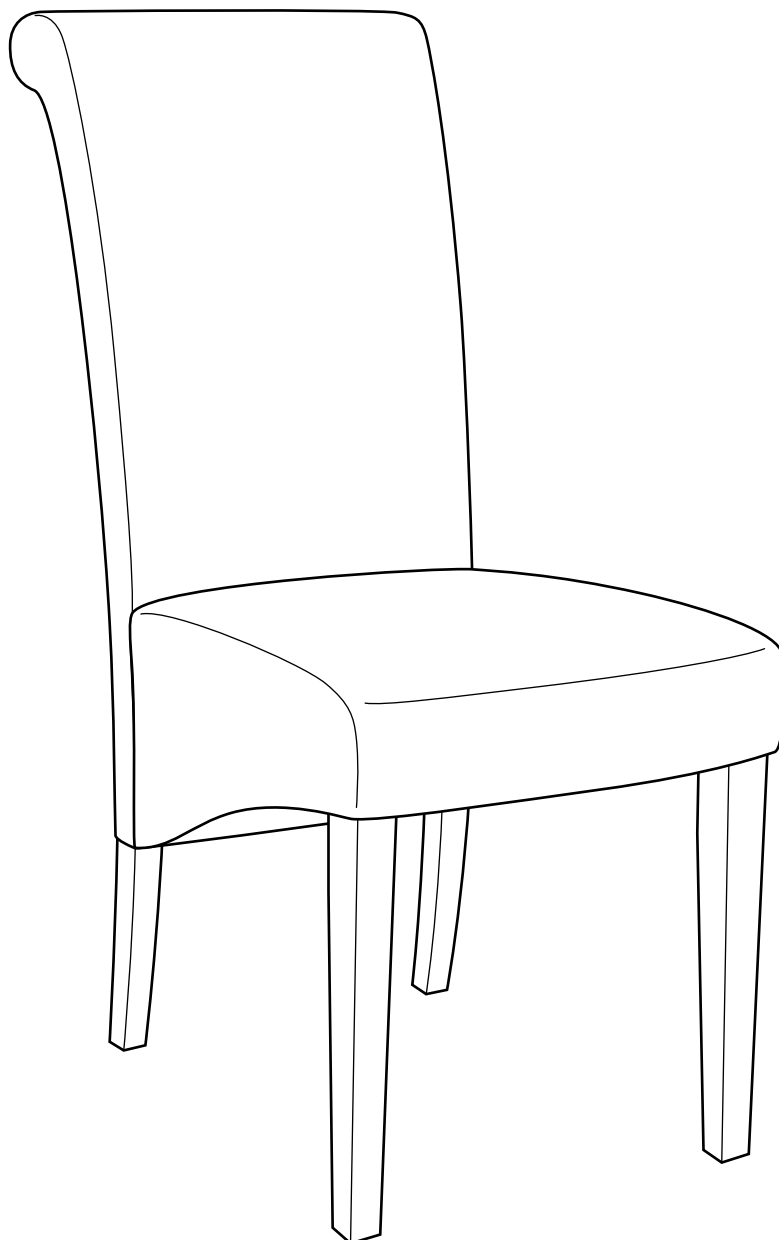

## Dimensions

Width - 46cm

Depth - 65cm

Height - 106cm

**Important - Please read these instructions fully before starting assembly**

If you need help or have damaged or missing parts, call the **Customer Helpline: 08456 400800**



# Safety and Care Advice

**Important - Please read these instructions fully before starting assembly**

- At least 2 people are required to assemble this product.
- Do not discard any of the packaging until you have checked that you have all the parts and the pack of fittings.
- Assemble this product on a flat protected surface.
- Assemble all parts loosely before tightening any bolts.

- Discard all extra fittings and keep fittings out of reach of children.
- Please note wood is a natural material, some slightly colour and grain variation and natural marks will be present.
- Maximum safe weight of user: 110kgs.
- Unit weight: 9.8 kgs.



- We do not recommend the use of power drill/drivers **for inserting screws**, as this could damage the unit. Only use hand screwdrivers.
- Dispose of all packaging carefully and responsibly.
- Retain assembly instruction for future reference.

## Warnings

- Do not stand on the chair.
- Do not use the chair as a step ladder.
- Do not sit with sharp objects in back pockets as this may damage the seat surface.
- Do not knock the surface of the seat against sharp solid surfaces.

## Care and maintenance

- Please clean the seat surface using either damp (not wet) cloth and a mild domestic soap solution or by using an appropriate polish.
- Do not use any abrasive materials when cleaning.
- From time to time check that there are no loose bolts on this unit.

# Components - Parts

If you have damaged or missing components,  
call the **Customer Helpline: 08456 400800**

Please check you have all the parts listed below

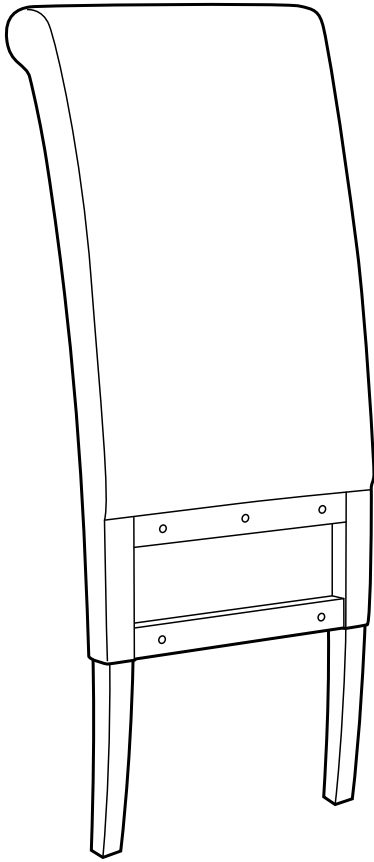

**1** Backrest  
(106 x 39.5 x 14cm)

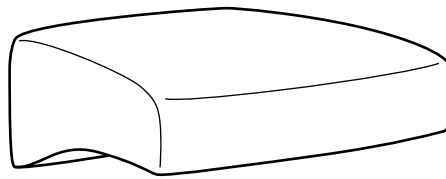

**2** Seat  
(44.5 x 46 x 25cm)



**3** Leg x 2  
(44.5 x 5.5/4.4cm)

# Components - Fittings

Please check you have all the fittings listed below

**Note:** The quantities below are the correct amount to complete the assembly. In some cases more fittings may be supplied than are required.

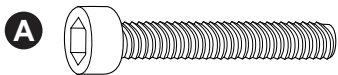

**A** M8 x 55mm Bolt x 9



**B** Washer x 9



**C** Allen key x 1

# Assembly Instructions

## Step 1

### Attaching the seat

Place the backrest **1** on a flat protected surface. Position the seat **2** on the backrest **1** as shown. Align the holes and fix using bolts **A** and washers **B**. Tighten the bolts using allen key **C**.



#### **Important:**

Peel off bottom cloth cover of seat to be able to fix the bolts. Pull the cloth from the back side of the seat.

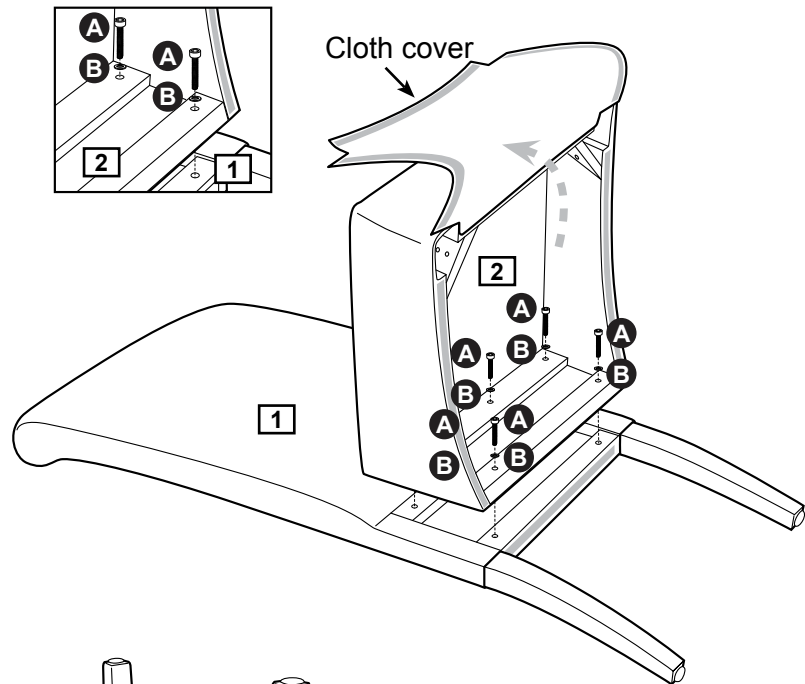

## Step 2

### Attaching legs

Carefully turn and place the chair onto a raised protected surface as shown. Insert the legs **3** into the holes of the seat **2**. Align the holes and fix using bolts **A** and washers **B**. Tighten the bolts using allen key **C**.

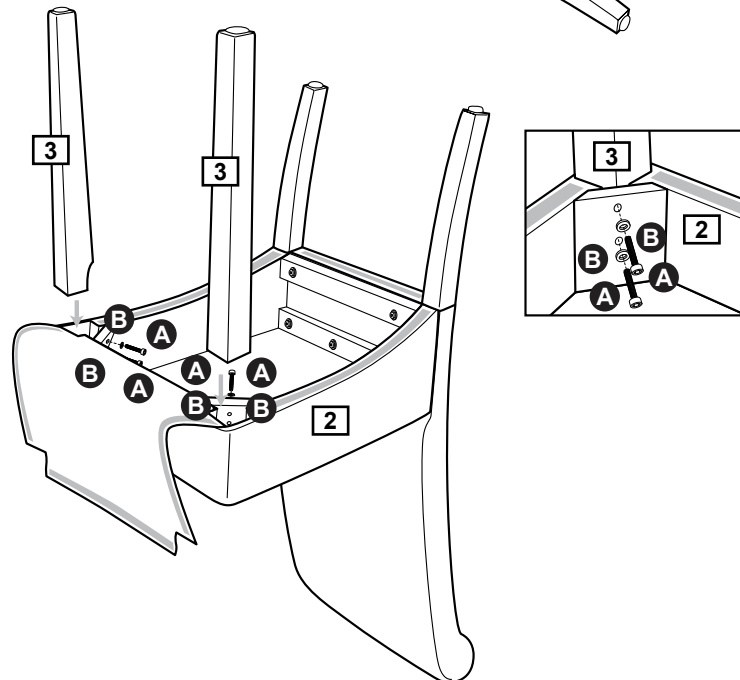

## Step 3

### Re-attaching the bottom cloth cover

Re-attach the bottom cloth cover as shown and fasten with the magic tape.

Carefully turn over the chair.

**Assembly is complete.**

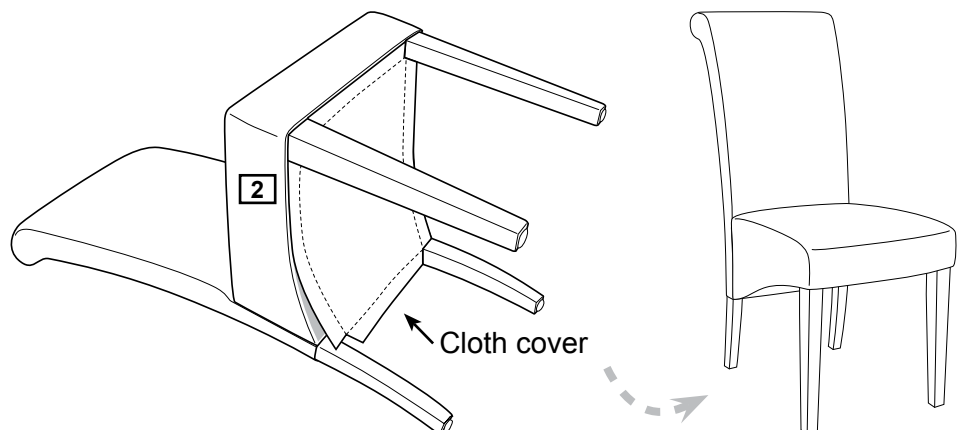

If you need help or have damaged or missing parts, call the **Customer Helpline: 08456 400800**

# Wickham Scroll-Back Chair

Assembly Instructions - Please keep for future reference

603/0115

603/0122

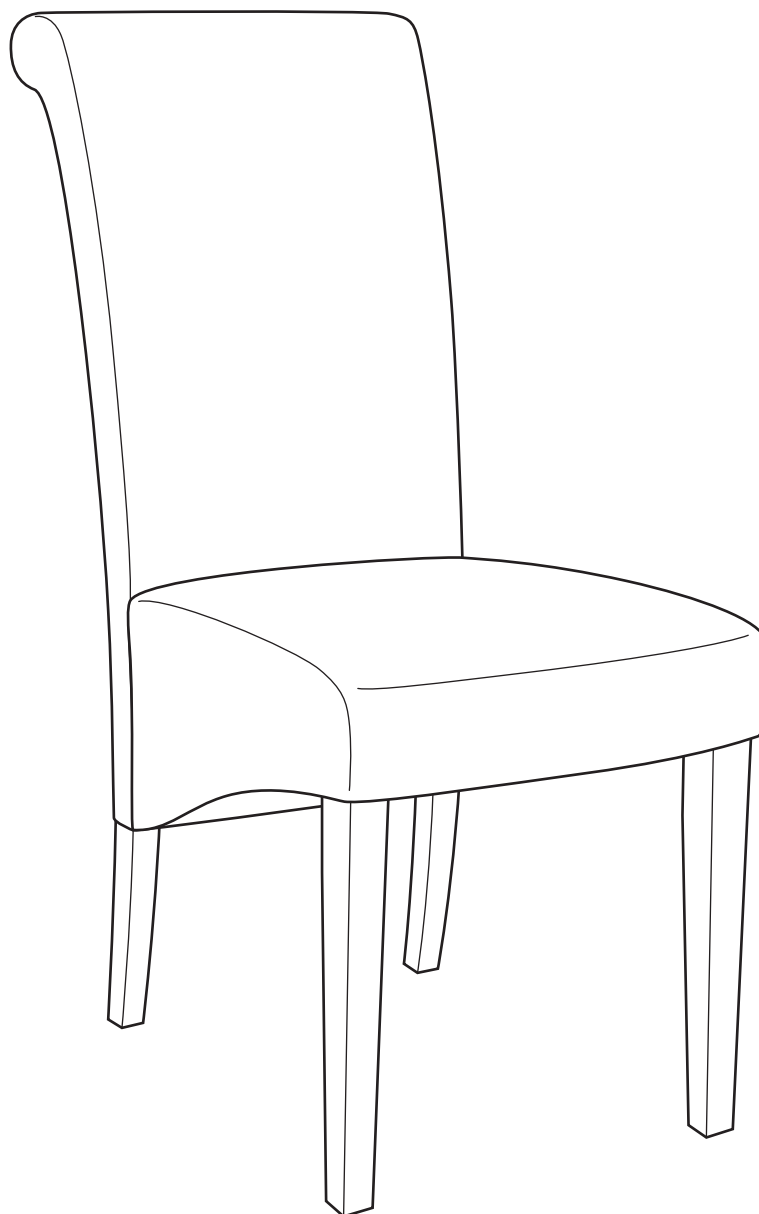

## Dimensions

Width - 46cm

Depth - 66cm

Height - 105cm

**Important - Please read these instructions fully before starting assembly**

If you need help or have damaged or missing parts, call the **Customer Helpline: 08456 400800**



# Safety and Care Advice

## Important - Please read these instructions fully before starting assembly

- At least 2 people are required to assemble this product.
- Do not discard any of the packaging until you have checked that you have all the parts and the pack of fittings.
- Assemble this product on a flat protected surface.
- Assemble all parts loosely before tightening any bolts.

- Discard all extra fittings and keep fittings out of reach of children.
- Please note wood is a natural material, some slightly colour and grain variation and natural marks will be present.
- Maximum safe weight of user: 110kgs.
- Unit weight: 7.5 kgs.



- We do not recommend the use of power drill/drivers **for inserting screws**, as this could damage the unit. Only use hand screwdrivers.
- Dispose of all packaging carefully and responsibly.
- Retain assembly instruction for future reference.

## Warnings

- Do not stand on the product.
- Do not use the product as a step ladder.
- Do not sit with sharp objects in back pockets as this may damage the seat surface.
- Do not knock the surface of the seat against sharp solid surfaces.

## Care and maintenance

- Please clean the product using either damp (not wet) cloth and a mild domestic soap solution or by using an appropriate polish.
- Do not use any abrasive materials when cleaning.
- From time to time check that there are no loose bolts on this unit.

# Components - Parts

If you have damaged or missing components, call the **Customer Helpline: 08456 400800**

Please check you have all the parts listed below

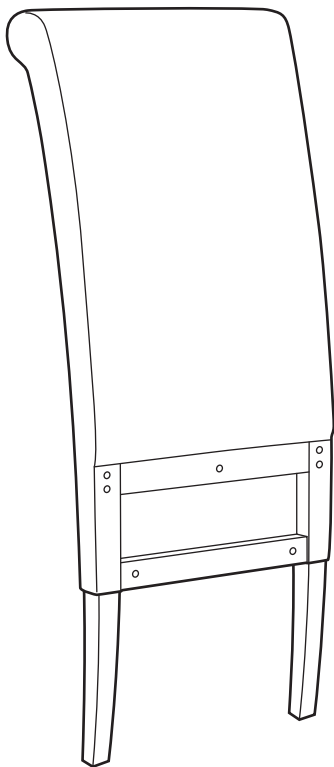

**1** Backrest  
(105 x 40 x 16cm)

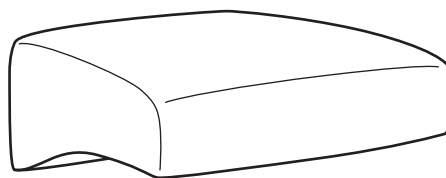

**2** Seat  
(46 x 42.5 x 23cm)







**3** Leg x 2  
(44 x 4 x 4cm)

# Components - Fittings

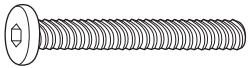
Please check you have all the fittings listed below

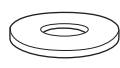
**Note:** The quantities below are the correct amount to complete the assembly. In some cases more fittings may be supplied than are required.

<p><b>A</b> </p> <p>M6 x 50mm Bolt x 11</p>	<p><b>B</b> </p> <p>Spring washer x 11</p>	<p><b>C</b> </p> <p>Flat washer x 11</p>
<p><b>D</b> </p> <p>Allen key x 1</p>	<p><b>E</b> </p> <p>Foot pad x 4</p>	

# Assembly Instructions

## Step 1

### Attaching legs

Place the seat **2** upside down on a flat protected surface.

Insert the legs **3** into the holes of the seat as shown and fix using bolts **A**, spring washers **B** and washers **C**.



#### Important:

Fasten bolts using allen key **D** but do not fully tighten at this stage.

#### Note:

Use oval head of allen key **D** on tight angles.

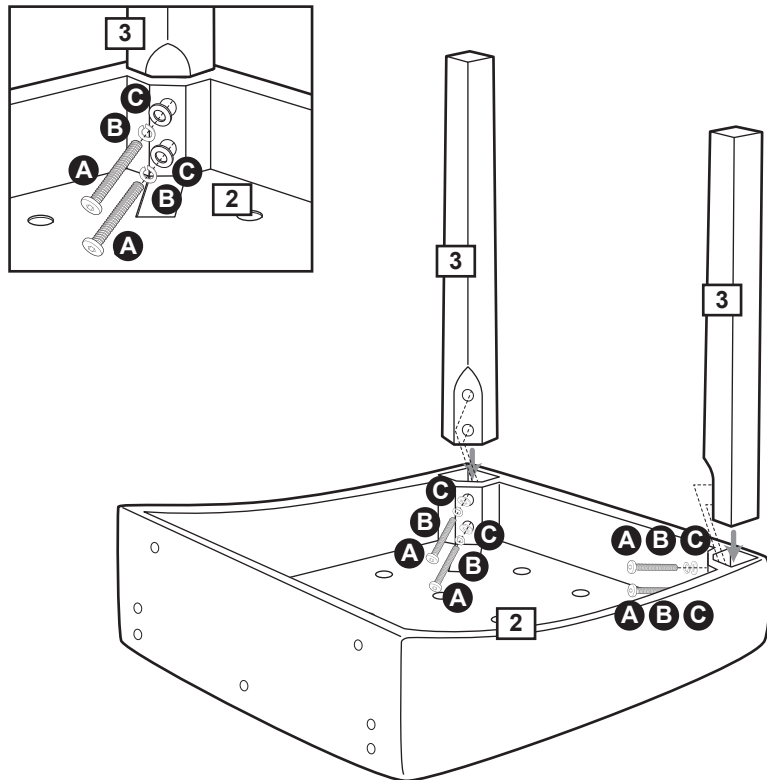

## Step 2

### a: Attaching the seat

Place the backrest **1** on a flat protected surface.

Position the seat **2** on the backrest **1** as shown and fix using bolts **A**, spring washers **B** and washers **C**.



#### Important:

Fasten bolts using allen key **D** but do not fully tighten at this stage.

#### Note:

Use oval head of allen key **D** on tight angles.

### b: Attaching foot pads

Remove backing from foot pads **E** and carefully position on the bottom of the legs **1** & **3**.

Carefully turn over the chair.

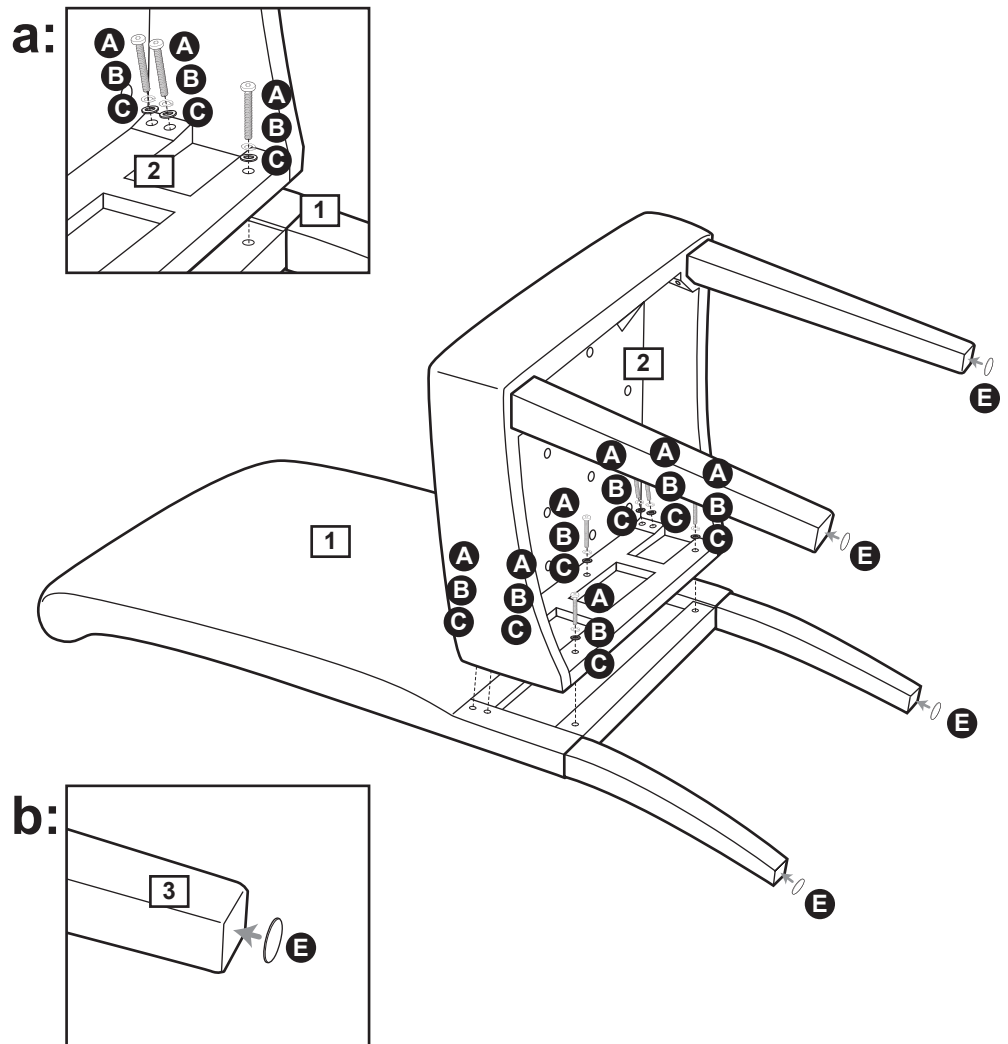



# Assembly Instructions

## Step 3

### Aligning & securing the legs

Carefully turn the chair upright and place on a flat surface.

**a:** Tighten all bolts using allen key **D**.

**Note:**

Use oval head of allen key **D** on tight angles.

**Note:** This step is essential to prevent the chair from wobbling due to uneven legs.

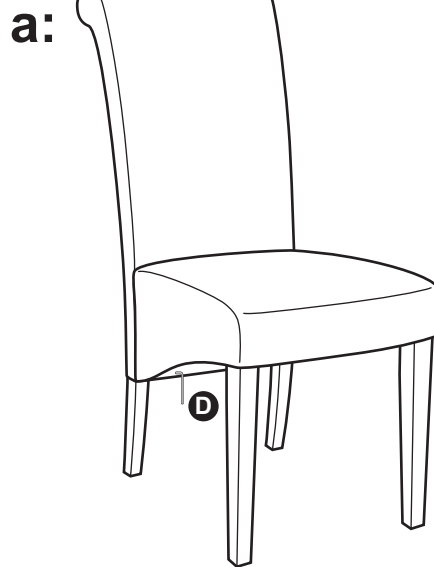

**b:** Carefully sit on the chair and make adjustments to ensure the legs are flat even on the floor.

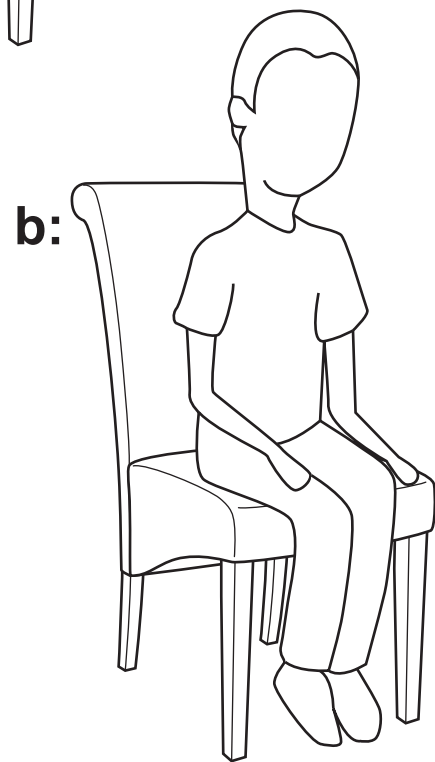

**c:** After the sitting test, re-tighten bolts again if any adjustment is needed.

**Note:** It is highly recommended to re-tighten all bolts after using the chair for 7 days.

**Note:** Keep allen key to re-tighten bolts when required.

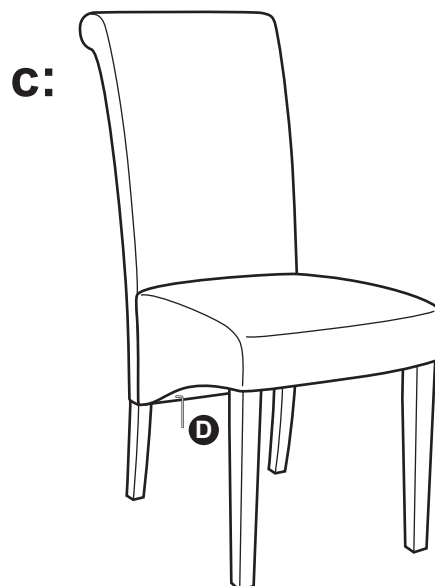

**Assembly is complete.**

If you need help or have damaged or missing parts, call the **Customer Helpline: 08456 400800**

# SCHR Eden Oak Veneer Table 180cm

Assembly Instructions - Please keep for future reference

603/3600

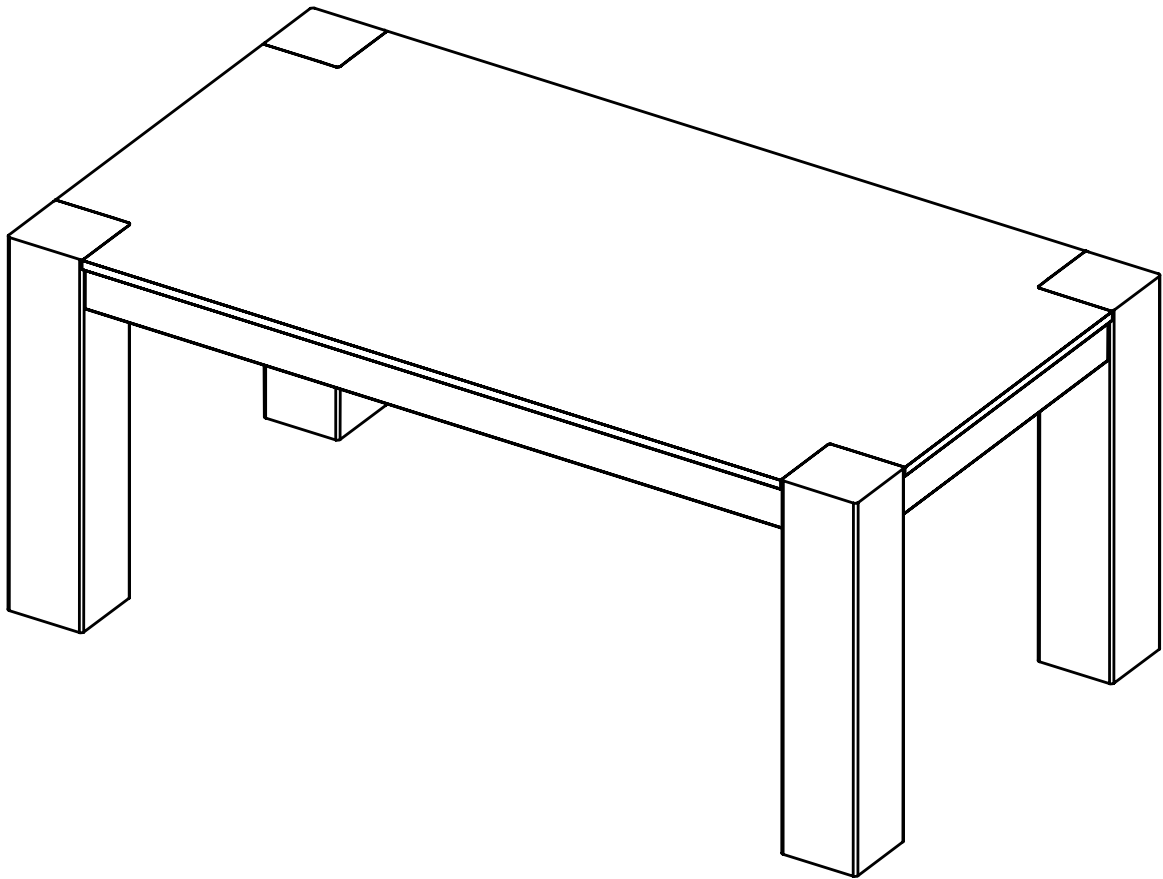

## Dimensions

Width - 180cm

Depth - 100cm

Height - 76cm

**Important – Please read these instructions fully before starting assembly**

If you need help or have damaged or missing parts, call the **Customer Helpline: 0845 640 0800**



# Safety and Care Advice

**Important** – Please read these instructions fully before starting assembly

- Check you have all the components and tools listed on pages 2 and 3.
- Remove all fittings from the plastic bags and separate them into their groups.
- Keep children and animals away from the work area, small parts could choke if swallowed.
- Make sure you have enough space to layout the parts before starting.

- Do not stand or put weight on the product, this could cause damage.
- Assemble the item as close to its final position (in the same room) as possible.
- Assemble on a soft level surface to avoid damaging the unit or your floor.
- Parts of the assembly will be easier with 2 people.



- We do not recommend the use of power drill/drivers **for inserting screws**, as this could damage the unit. Only use hand screwdrivers.
- Dispose of all packaging carefully and responsibly.

## Care and maintenance

- Only clean using a damp cloth and mild detergent, do not use bleach or abrasive cleaners.
- From time to time check that there are no loose screws on this unit.
- This product should not be discarded with household waste. Take to your local authority waste disposal centre.

# Components - Panels

If you have damaged or missing components, call the **Customer Helpline: 0845 640 0800**

Please check you have all the panels listed below

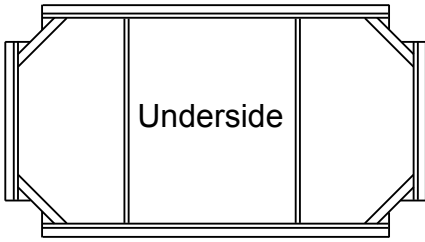

1 Top (180 x 100cm)





2 Leg x 4 (76 x 16cm)

# Components - Fittings

Please check you have all the fittings listed below

**Note:** The quantities below are the correct amount to complete the assembly. In some cases more fittings may be supplied than are required.

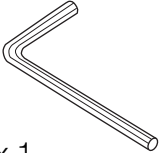
<p><b>A</b> </p> <p>Bolt x 8 ( M8 x 64mm )</p>	<p><b>B</b> </p> <p>Flat washer x 8</p>	<p><b>C</b> </p> <p>Spring washer x 8</p>
<p><b>D</b> </p> <p>Hex key x 1</p>		

Tools required



Ruler - Use this ruler to help correctly identify the screws









# Assembly Instructions

## Step 1

### Attaching legs

Match the legs and table top corners by the symbols  & .

Attach four legs  to top  using washer  spring washer  and bolt . Tighten the bolts with hex key .

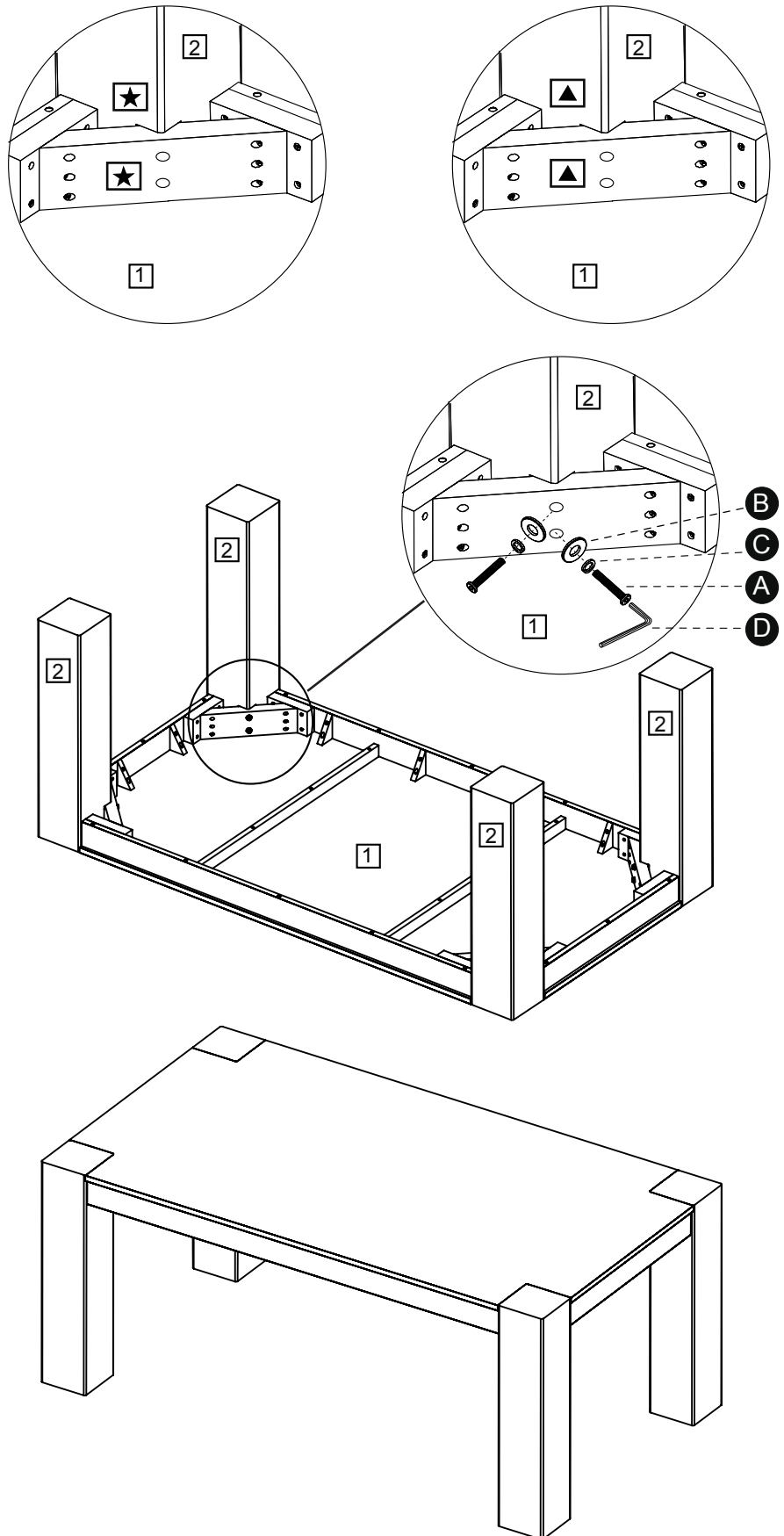

## Step 2

Turn the table over carefully.

**Assembly is complete.**

If you need help or have damaged or missing parts, call the **Customer Helpline: 0845 640 0800**  
Argos Ltd MK9 2NW