

Baltimore Scroll-Back Chair

Assembly Instructions - Please keep for future reference

603/0115

603/0122

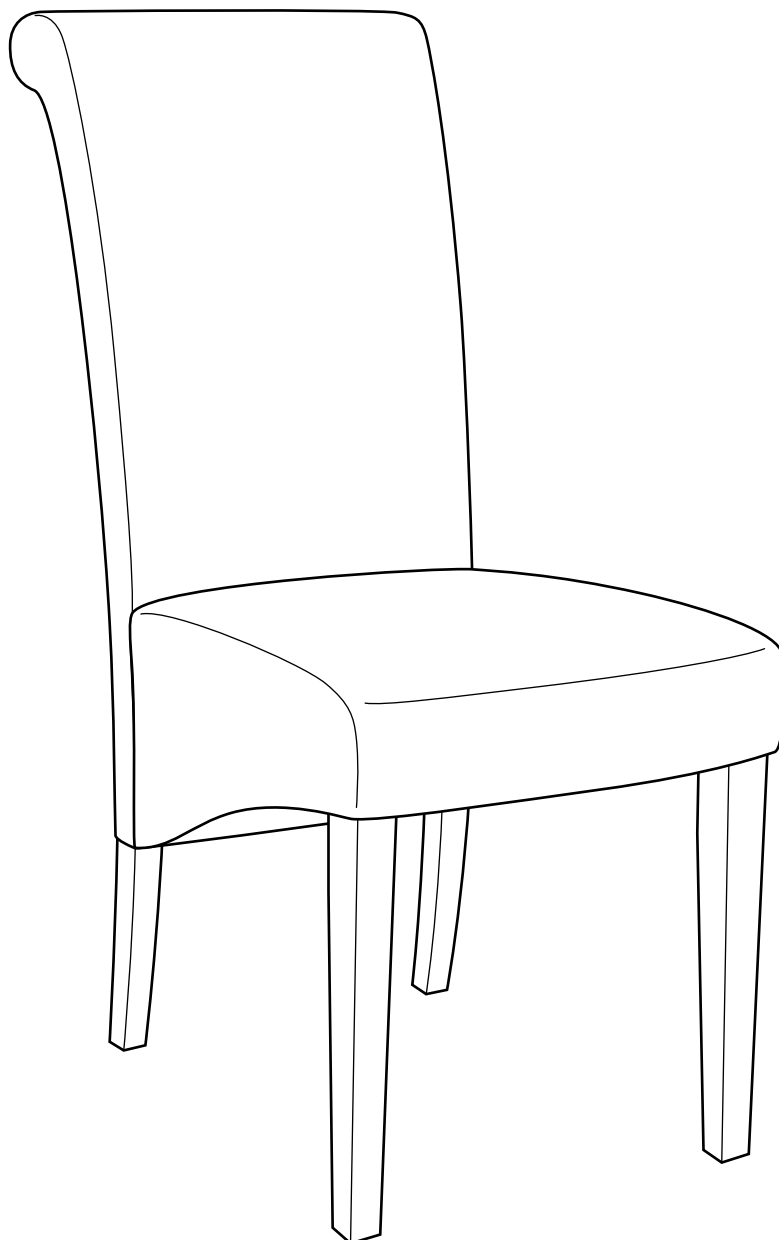

Dimensions

Width - 46cm

Depth - 65cm

Height - 106cm

Important - Please read these instructions fully before starting assembly

If you need help or have damaged or missing parts, call the **Customer Helpline: 08456 400800**



Safety and Care Advice

Important - Please read these instructions fully before starting assembly

- At least 2 people are required to assemble this product.
- Do not discard any of the packaging until you have checked that you have all the parts and the pack of fittings.
- Assemble this product on a flat protected surface.
- Assemble all parts loosely before tightening any bolts.

- Discard all extra fittings and keep fittings out of reach of children.
- Please note wood is a natural material, some slightly colour and grain variation and natural marks will be present.
- Maximum safe weight of user: 110kgs.
- Unit weight: 9.8 kgs.



- We do not recommend the use of power drill/drivers **for inserting screws**, as this could damage the unit. Only use hand screwdrivers.
- Dispose of all packaging carefully and responsibly.
- Retain assembly instruction for future reference.

Warnings

- Do not stand on the chair.
- Do not use the chair as a step ladder.
- Do not sit with sharp objects in back pockets as this may damage the seat surface.
- Do not knock the surface of the seat against sharp solid surfaces.

Care and maintenance

- Please clean the seat surface using either damp (not wet) cloth and a mild domestic soap solution or by using an appropriate polish.
- Do not use any abrasive materials when cleaning.
- From time to time check that there are no loose bolts on this unit.

Components - Parts

If you have damaged or missing components, call the **Customer Helpline: 08456 400800**

Please check you have all the parts listed below

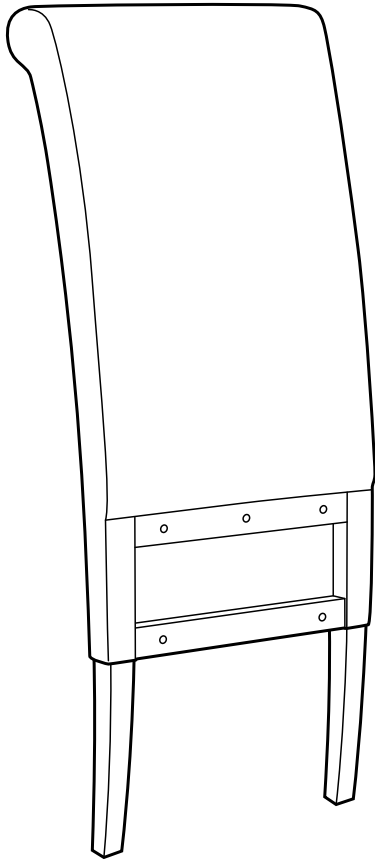

1 Backrest
(106 x 39.5 x 14cm)

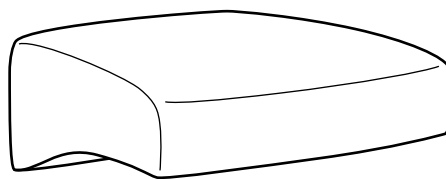

2 Seat
(44.5 x 46 x 25cm)



3 Leg x 2
(44.5 x 5.5/4.4cm)

Components - Fittings

Please check you have all the fittings listed below

Note: The quantities below are the correct amount to complete the assembly. In some cases more fittings may be supplied than are required.

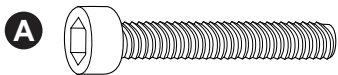

A M8 x 55mm Bolt x 9



B Washer x 9



C Allen key x 1

Assembly Instructions

Step 1

Attaching the seat

Place the backrest **1** on a flat protected surface. Position the seat **2** on the backrest **1** as shown. Align the holes and fix using bolts **A** and washers **B**. Tighten the bolts using allen key **C**.



Important:

Peel off bottom cloth cover of seat to be able to fix the bolts. Pull the cloth from the back side of the seat.

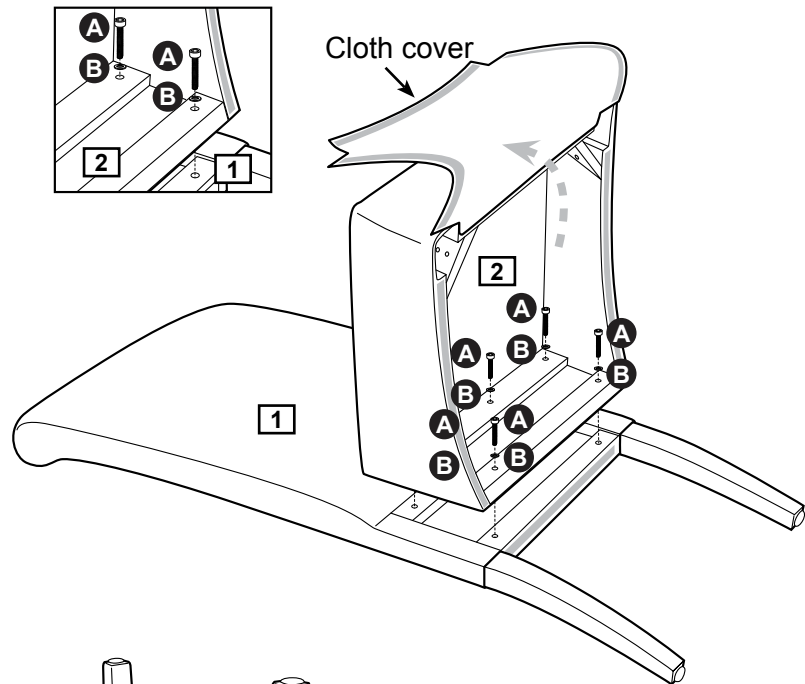

Step 2

Attaching legs

Carefully turn and place the chair onto a raised protected surface as shown. Insert the legs **3** into the holes of the seat **2**. Align the holes and fix using bolts **A** and washers **B**. Tighten the bolts using allen key **C**.

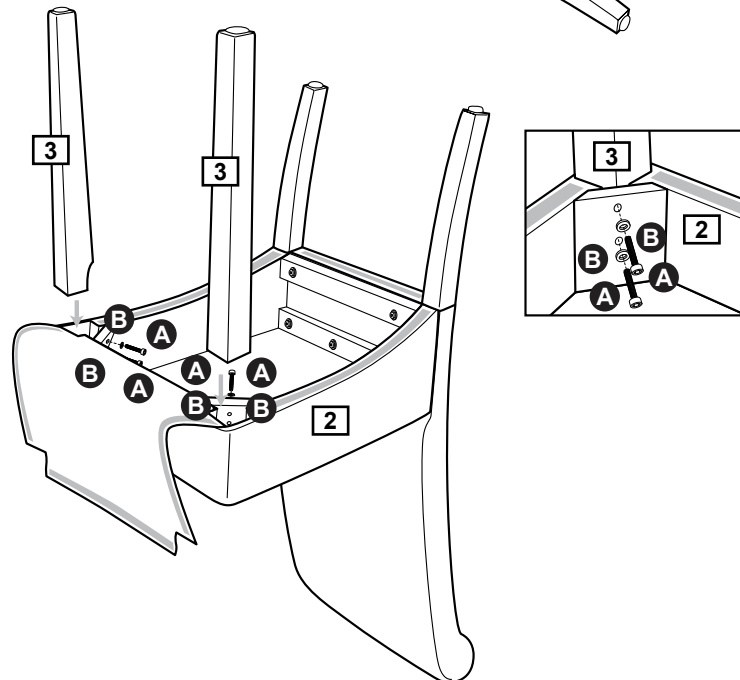

Step 3

Re-attaching the bottom cloth cover

Re-attach the bottom cloth cover as shown and fasten with the magic tape.

Carefully turn over the chair.

Assembly is complete.

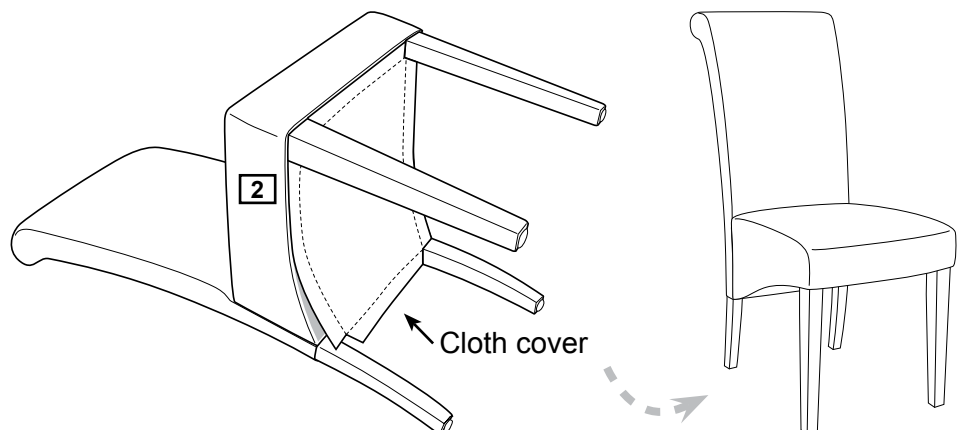

If you need help or have damaged or missing parts, call the **Customer Helpline: 08456 400800**

Wickham Scroll-Back Chair

Assembly Instructions - Please keep for future reference

603/0115

603/0122

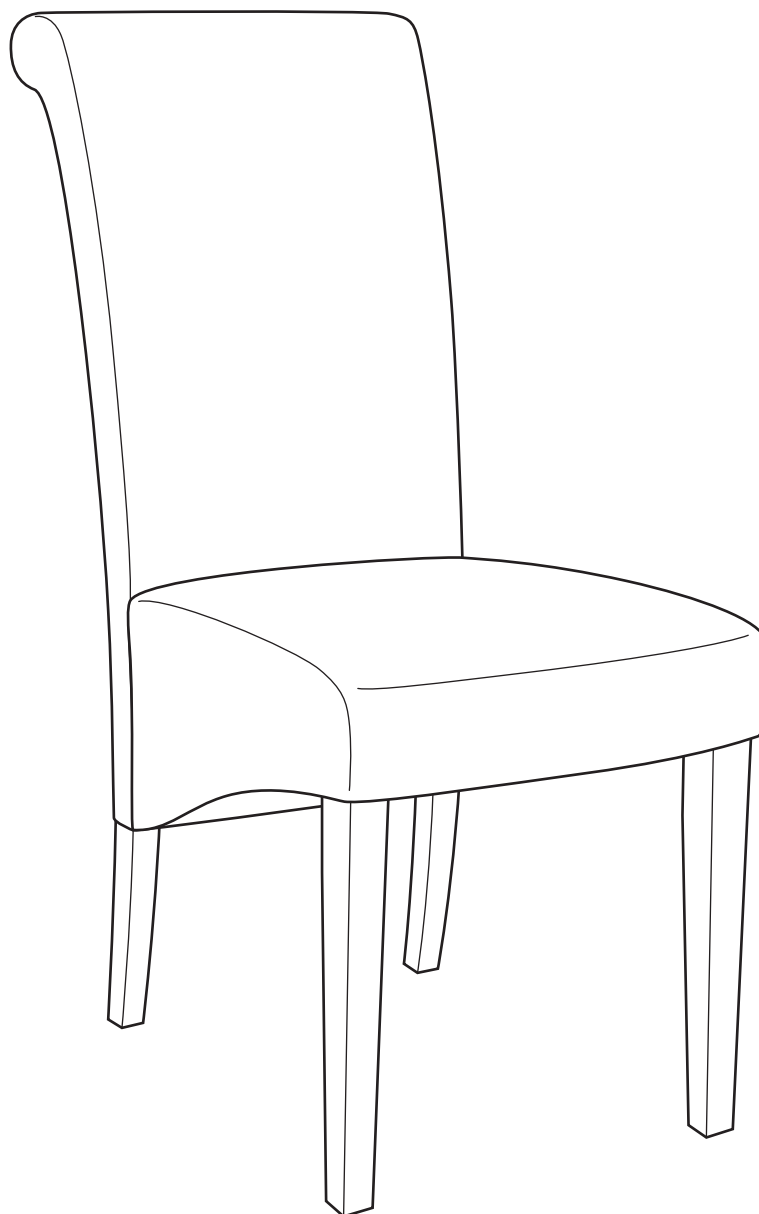

Dimensions

Width - 46cm

Depth - 66cm

Height - 105cm

Important - Please read these instructions fully before starting assembly

If you need help or have damaged or missing parts, call the **Customer Helpline: 08456 400800**



Safety and Care Advice

Important - Please read these instructions fully before starting assembly

- At least 2 people are required to assemble this product.
- Do not discard any of the packaging until you have checked that you have all the parts and the pack of fittings.
- Assemble this product on a flat protected surface.
- Assemble all parts loosely before tightening any bolts.

- Discard all extra fittings and keep fittings out of reach of children.
- Please note wood is a natural material, some slightly colour and grain variation and natural marks will be present.
- Maximum safe weight of user: 110kgs.
- Unit weight: 7.5 kgs.



- We do not recommend the use of power drill/drivers **for inserting screws**, as this could damage the unit. Only use hand screwdrivers.
- Dispose of all packaging carefully and responsibly.
- Retain assembly instruction for future reference.

Warnings

- Do not stand on the product.
- Do not use the product as a step ladder.
- Do not sit with sharp objects in back pockets as this may damage the seat surface.
- Do not knock the surface of the seat against sharp solid surfaces.

Care and maintenance

- Please clean the product using either damp (not wet) cloth and a mild domestic soap solution or by using an appropriate polish.
- Do not use any abrasive materials when cleaning.
- From time to time check that there are no loose bolts on this unit.

Components - Parts

If you have damaged or missing components, call the **Customer Helpline: 08456 400800**

Please check you have all the parts listed below

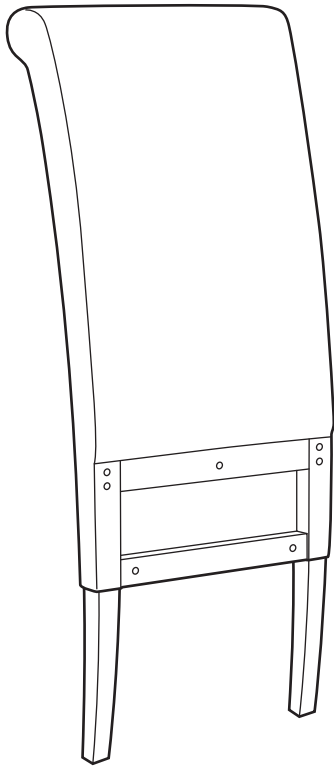

1 Backrest
(105 x 40 x 16cm)

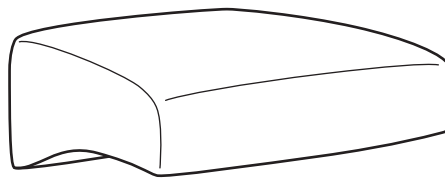

2 Seat
(46 x 42.5 x 23cm)







3 Leg x 2
(44 x 4 x 4cm)

Components - Fittings

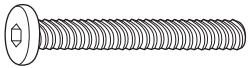
Please check you have all the fittings listed below

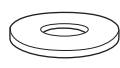
Note: The quantities below are the correct amount to complete the assembly. In some cases more fittings may be supplied than are required.

<p>A </p> <p>M6 x 50mm Bolt x 11</p>	<p>B </p> <p>Spring washer x 11</p>	<p>C </p> <p>Flat washer x 11</p>
<p>D </p> <p>Allen key x 1</p>	<p>E </p> <p>Foot pad x 4</p>	

Assembly Instructions

Step 1

Attaching legs

Place the seat **2** upside down on a flat protected surface.

Insert the legs **3** into the holes of the seat as shown and fix using bolts **A**, spring washers **B** and washers **C**.



Important:

Fasten bolts using allen key **D** but do not fully tighten at this stage.

Note:

Use oval head of allen key **D** on tight angles.

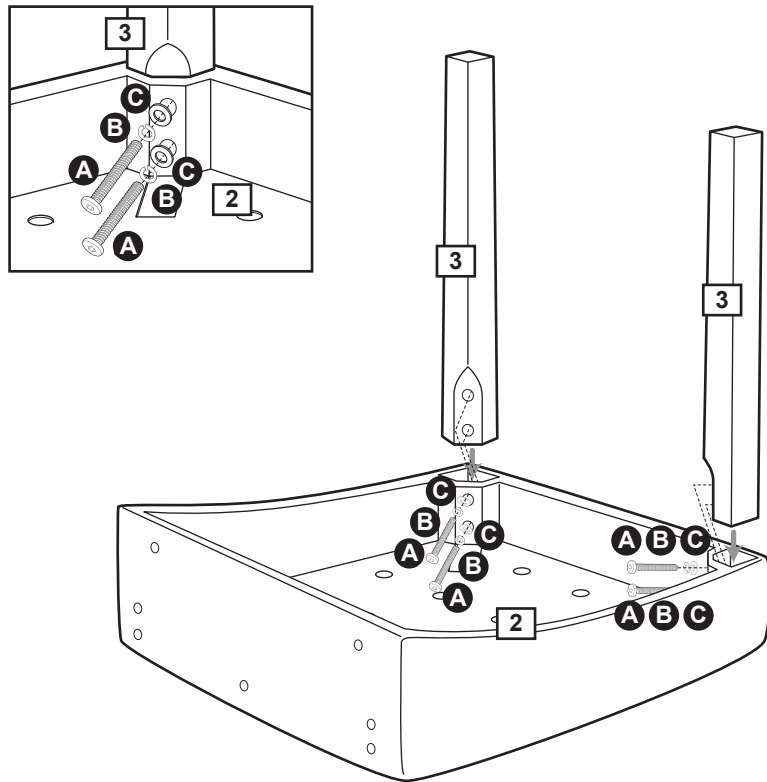

Step 2

a: Attaching the seat

Place the backrest **1** on a flat protected surface.

Position the seat **2** on the backrest **1** as shown and fix using bolts **A**, spring washers **B** and washers **C**.



Important:

Fasten bolts using allen key **D** but do not fully tighten at this stage.

Note:

Use oval head of allen key **D** on tight angles.

b: Attaching foot pads

Remove backing from foot pads **E** and carefully position on the bottom of the legs **1** & **3**.

Carefully turn over the chair.

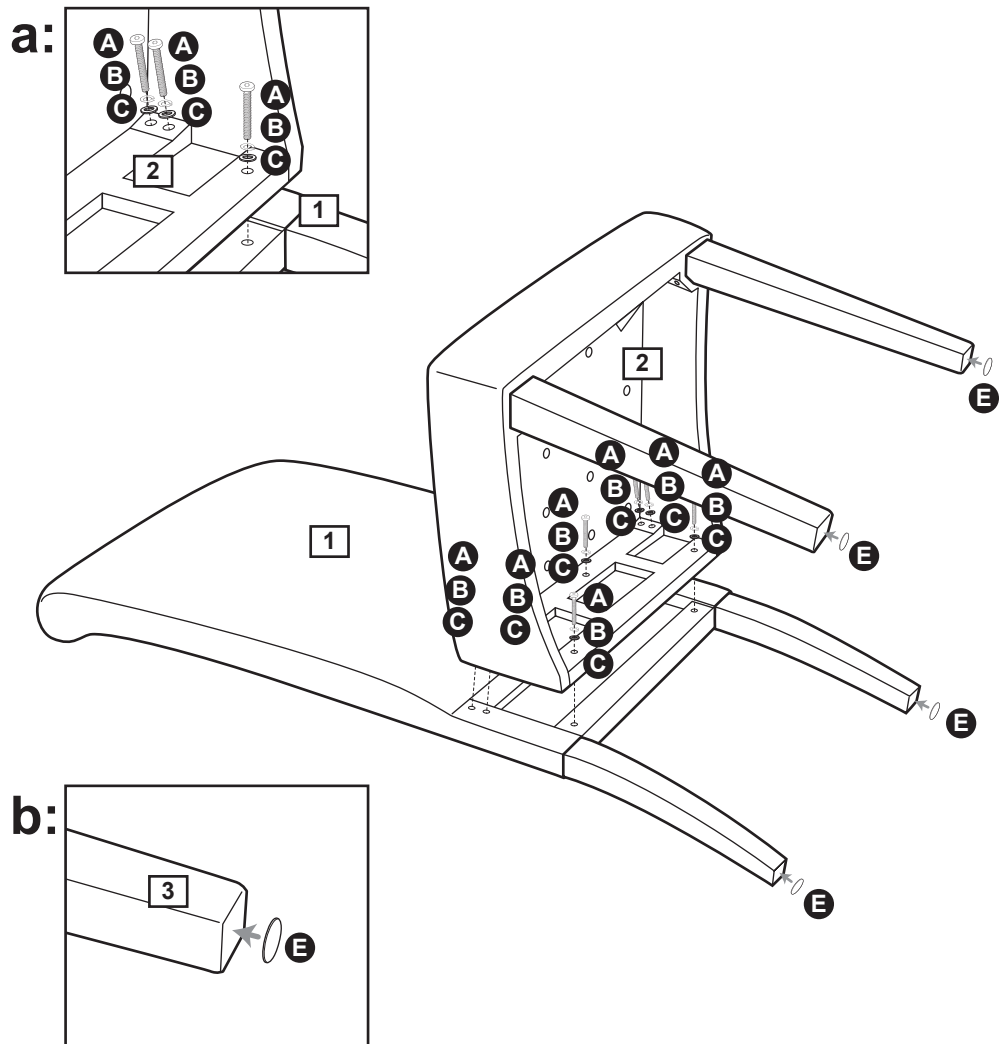

Assembly Instructions

Step 3

Aligning & securing the legs

Carefully turn the chair upright and place on a flat surface.

a: Tighten all bolts using allen key **D**.

Note:

Use oval head of allen key **D** on tight angles.

Note: This step is essential to prevent the chair from wobbling due to uneven legs.

a:

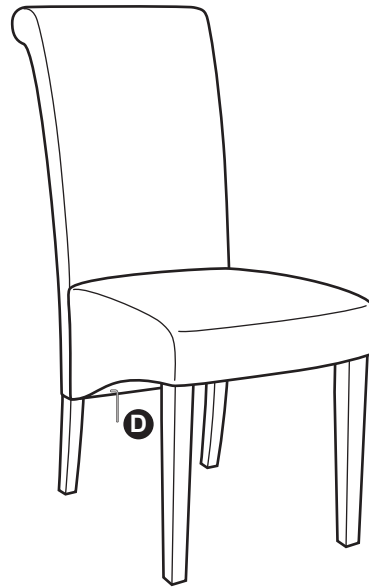

b: Carefully sit on the chair and make adjustments to ensure the legs are flat even on the floor.

b:



c: After the sitting test, re-tighten bolts again if any adjustment is needed.

Note: It is highly recommended to re-tighten all bolts after using the chair for 7 days.

Note: Keep allen key to re-tighten bolts when required.

c:

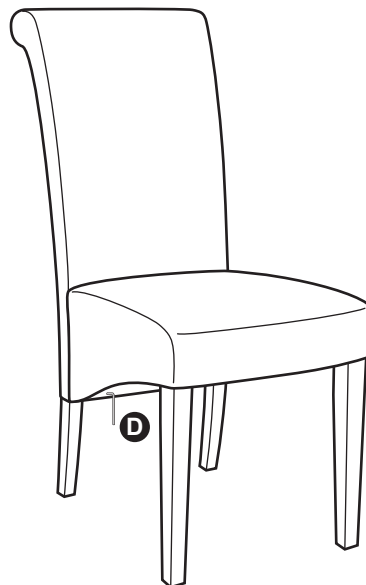

Assembly is complete.

If you need help or have damaged or missing parts, call the **Customer Helpline: 08456 400800**

SCHR Eden Oak Veneer Table 150cm

Assembly Instructions - Please keep for future reference

603/5347

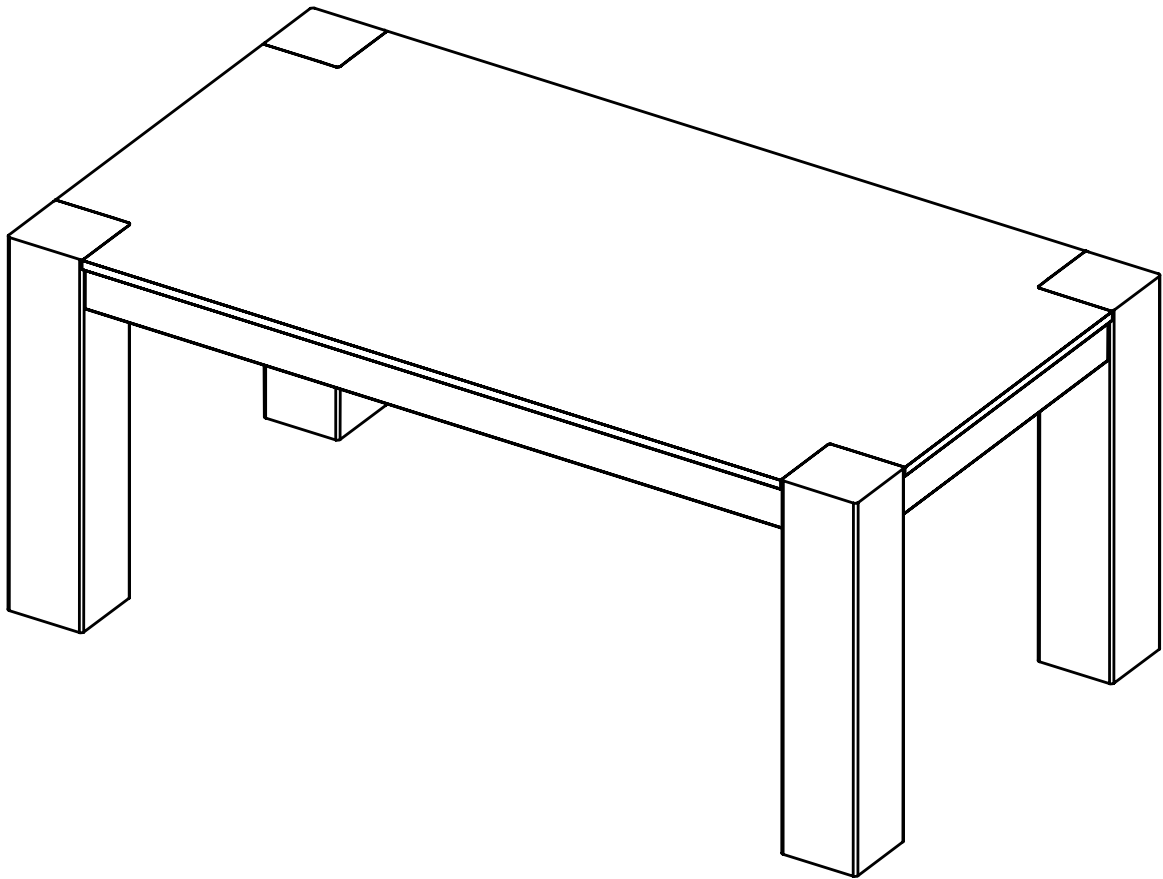

Dimensions

Width - 150cm
Depth - 90cm
Height - 76cm

Important – Please read these instructions fully before starting assembly

If you need help or have damaged or missing parts, call the **Customer Helpline: 0845 640 0800**



Safety and Care Advice

Important – Please read these instructions fully before starting assembly

- Check you have all the components and tools listed on pages 2 and 3.
- Remove all fittings from the plastic bags and separate them into their groups.
- Keep children and animals away from the work area, small parts could choke if swallowed.
- Make sure you have enough space to layout the parts before starting.

- Do not stand or put weight on the product, this could cause damage.
- Assemble the item as close to its final position (in the same room) as possible.
- Assemble on a soft level surface to avoid damaging the unit or your floor.
- Parts of the assembly will be easier with 2 people.



- We do not recommend the use of power drill/drivers **for inserting screws**, as this could damage the unit. Only use hand screwdrivers.
- Dispose of all packaging carefully and responsibly.

Care and maintenance

- Only clean using a damp cloth and mild detergent, do not use bleach or abrasive cleaners.
- From time to time check that there are no loose screws on this unit.
- This product should not be discarded with household waste. Take to your local authority waste disposal centre.

Components - Panels

If you have damaged or missing components, call the **Customer Helpline: 0845 640 0800**

Please check you have all the panels listed below

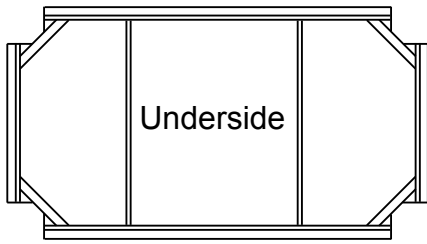

1 Top (150 x 90cm)





2 Leg x 4 (76 x 12cm)

Components - Fittings

Please check you have all the fittings listed below

Note: The quantities below are the correct amount to complete the assembly. In some cases more fittings may be supplied than are required.

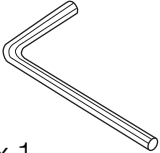
<p>A </p> <p>Bolt x 8 (M8 x 64mm)</p>	<p>B </p> <p>Flat washer x 8</p>	<p>C </p> <p>Spring washer x 8</p>
<p>D </p> <p>Hex key x 1</p>		

Tools required

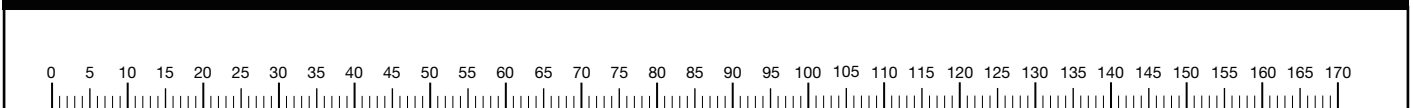

Ruler - Use this ruler to help correctly identify the screws









Assembly Instructions

Step 1

Attaching legs

Match the legs and table top corners by the symbols  & .

Attach four legs  to top  using washer , spring washer  and bolt . Tighten the bolts with hex key .

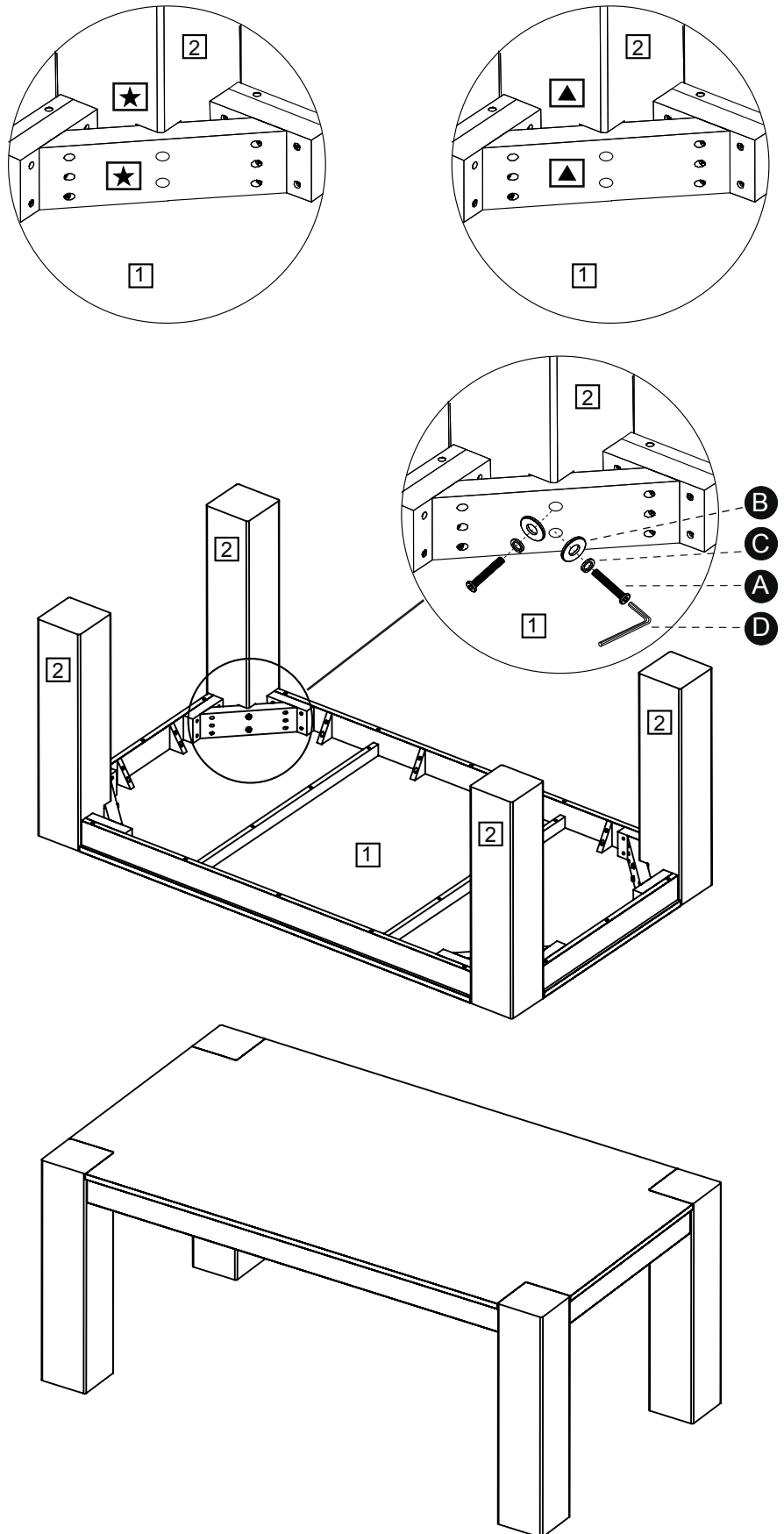

Step 2

Turn the table over carefully.

Assembly is complete.

If you need help or have damaged or missing parts, call the **Customer Helpline: 0845 640 0800**
Argos Ltd MK9 2NW