

# Vespa Dining Chairs

Assembly Instructions - Please keep for future reference

603/6717

**hygena**

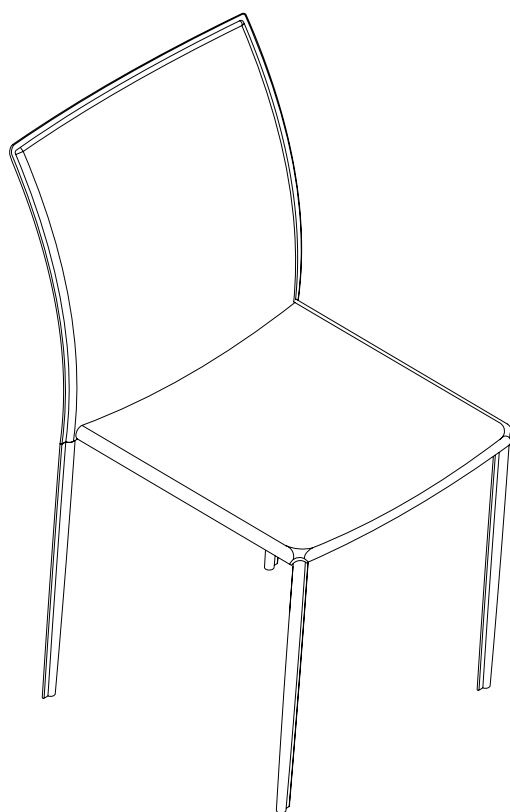

## Dimensions

Width - 42.5cm

Depth - 53cm

Height - 86cm

**Important - Please read these instructions fully before starting assembly**

If you need help or have damaged or missing parts, call the **Customer Helpline: 08456 400800**



# Safety and Care Advice

## Important - Please read these instructions fully before starting assembly

- Check you have all the components and tools listed on pages 2 and 3.
- Remove all fittings from the plastic bags and separate them into their groups.
- Keep children and animals away from the work area, small parts could choke if swallowed.
- Assemble the item as close to its final position (in the same room) as possible.
- Make sure you have enough space to layout the parts before starting.
- Dispose of all packaging carefully and responsibly.
- Keep these instructions for further use.
- Assemble on a soft level surface to avoid damaging the unit or your floor.
- To ensure an easier assembly, we strongly advise that all fittings are only finger tightened during initial assembly. Only upon completion of the assembly should all fixing points be fully tightened.

## Cleaning Guidance

- Minor stains and spillages should be removed immediately from cushion fabric, by wiping over lightly with a damp cloth and mild soapy water.
- Light marking can also be removed using this method.
- To remove more stubborn stains or marking, a good quality proprietary domestic fabric cleaner can be used, although it should first be tested on an inconspicuous area of the fabric.

## Care and maintenance

- From time to time check that there are no loose screws on this unit.
- This product should not be discarded with household waste. Take to your local authority waste disposal centre.

# Components - Parts

If you have damaged or missing components,  
call the **Customer Helpline: 08456 400800**

Please check you have all the parts listed below

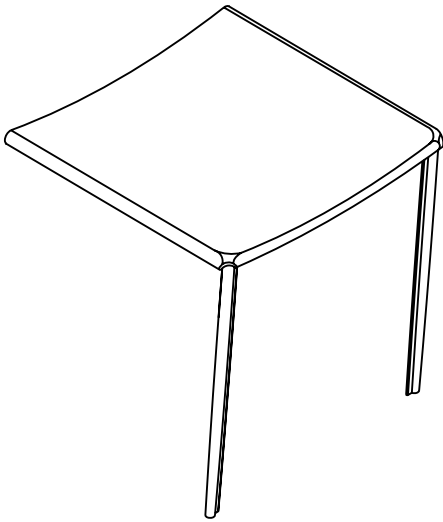

**1** Seat frame x 4

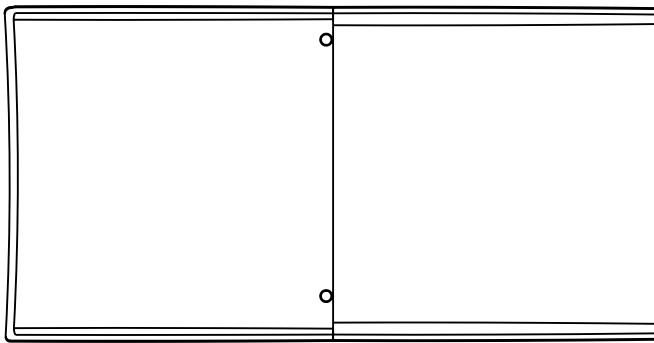

**2** Back rest x 4

# Components - Fittings

If you have damaged or missing components, call the **Customer Helpline: 08456 400800**

Please check you have all the fittings listed below

**Note:** The quantities below are the correct amount to complete the assembly. In some cases more fittings may be supplied than are required.

**A**

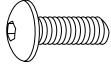

13mm Allen screw x 16

**B**



Spring washer x 16

**C**



Allen key x 1

## Tools required

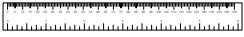

Ruler/tape  
measure

**Ruler** - Use this ruler to help correctly identify the screws

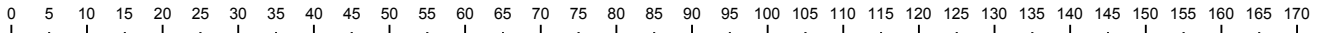

0 5 10 15 20 25 30 35 40 45 50 55 60 65 70 75 80 85 90 95 100 105 110 115 120 125 130 135 140 145 150 155 160 165 170

# Assembly Instructions

## Step 1

### Attaching seat pad

Lay back rest **2** flat on to the floor.

**Note:** Ensure the fixing brackets are facing upwards as shown.

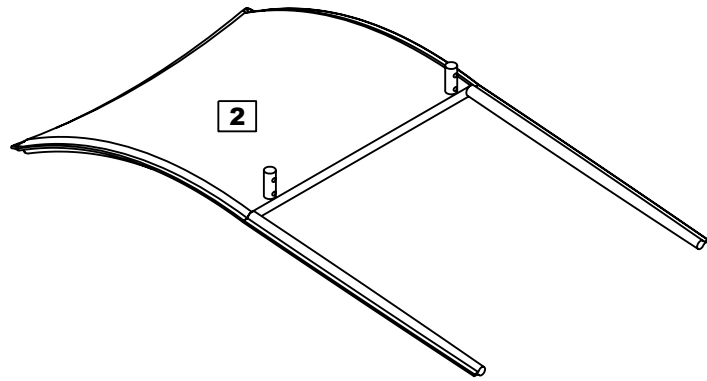

## Step 2

### Attaching seat pad

Locate seat frame **1** into position and secure using fixings **A** and **B**.

Stand the Chair upright.

Repeat for all 4 chairs.

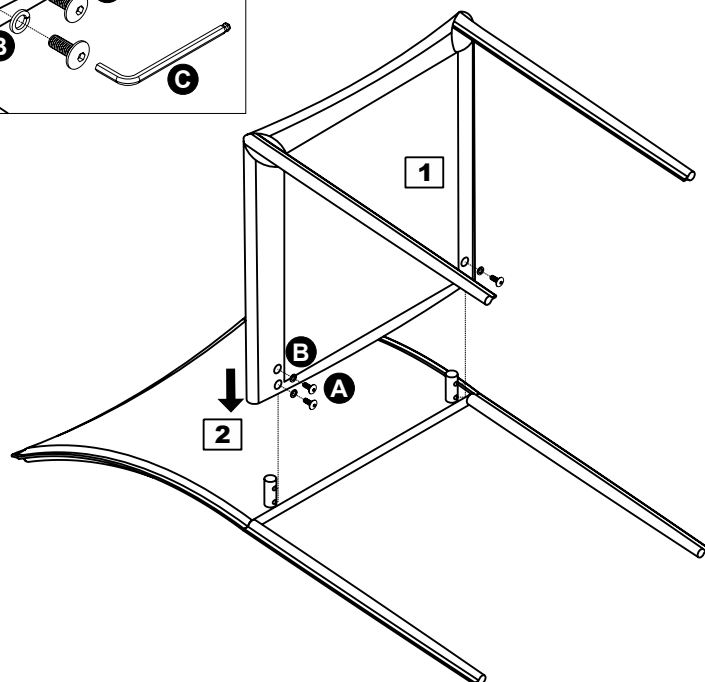
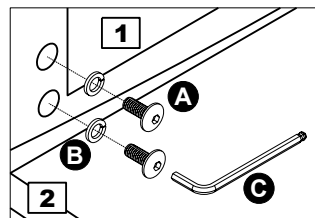

**Assembly is complete.**

If you need help or have damaged or missing parts, call the **Customer Helpline: 08456 400800**  
Home Retail Group, 489-499 Avebury Boulevard, Saxon Gate West, Central Milton Keynes, MK9 2NW

# Vespa Dining Table

Assembly Instructions - Please keep for future reference

603/6724

**hygena**



## Dimensions

Width - 90cm  
Depth - 150cm  
Height - 75cm

**Important - Please read these instructions fully before starting assembly**

If you need help or have damaged or missing parts, call the **Customer Helpline: 08456 400800**



# Safety and Care Advice

## Important – Please read these instructions fully before starting assembly

- Check you have all the components and tools listed on pages 2 and 3.
- Remove all fittings from the plastic bags and separate them into their groups.
- Keep children and animals away from the work area, small parts could choke if swallowed.
- Make sure you have enough space to layout the parts before starting.
- Do not stand or put excessive weight on the product, this could cause damage.
- Assemble the item as close to its final position (in the same room) as possible.
- Parts of the assembly will be easier with 2 people.
- Dispose of all packaging carefully and responsibly.
- Place the product on flat and steady surface during use.
- Assemble on a soft level surface to avoid damaging the unit or your floor.
- Keep these instructions for further use.
- To ensure an easier assembly, we strongly advise that all fittings are only finger tightened during initial assembly. Only upon completion of the assembly should all fixing points be fully tightened.

## Glass safety

- This product complies with BS EN 12521: 2009.
- Imported by:  
Home Retail Group.  
489-499 Avebury Boulevard.  
Saxon Gate West.  
Central Milton Keynes.  
MK9 2NW
- Product Cat no.:603/6724(D)
- P/O No:
- If the glass is chipped or broken, stop using the product and consult the Manufacturer or Supplier.

## Warnings

- a) Do not place very hot or very cold items on the glass surface(s) unless adequately thick table mats are used to prevent such items from coming into contact with the glass.
- b) Do not sit or stand upon the glass surface(s).
- c) Do not use the glass as a chopping surface. Do not strike the glass with hard or pointed items.
- d) When cleaning glass panels use a damp cloth or leather with washing up liquid or soft soap if necessary, do not use washing powders or any other substance containing abrasives since these substances scratch glass.

## Care and maintenance

- Only clean using a damp cloth and mild detergent, do not use bleach or abrasive cleaners.
- From time to time check that there are no loose screws on this unit.
- This product should not be discarded with household waste. Take to your local authority waste disposal centre.

# Components - Parts

If you have damaged or missing components,  
call the **Customer Helpline: 08456 400800**

Please check you have all the parts listed below

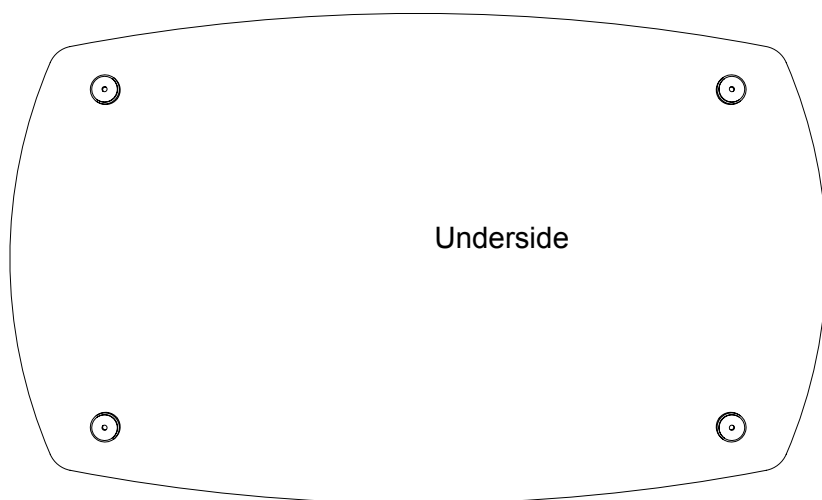

- 1** Glass top (150 x 90cm)

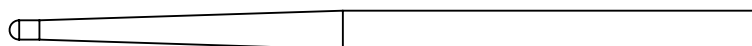

- 2** Leg x 4 (Ø5.1 x 73.8cm)





# Components - Fittings

If you have damaged or missing components, call the **Customer Helpline: 08456 400800**

Please check you have all the fittings listed below

**Note:** The quantities below are the correct amount to complete the assembly. In some cases more fittings may be supplied than are required.

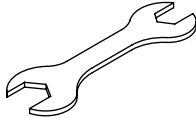
<p><b>A</b></p>  <p>40mm Threaded stud x 4</p>	<p><b>B</b></p>  <p>Nut x 4</p>	<p><b>C</b></p>  <p>Spanner x 1</p>
---	--	--

## Tools required

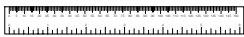

Ruler/tape  
measure

## Ruler - Use this ruler to help correctly identify the screws

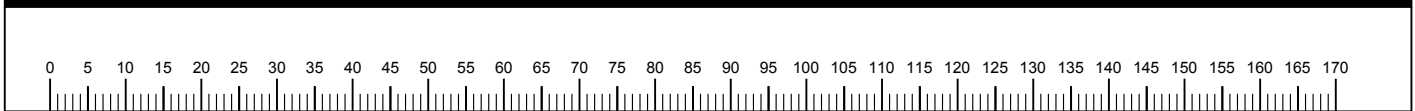

# Assembly Instructions

## Step 1

### Attaching legs



**Warning:**

Carefully place glass top **1** upside down onto a clean flat surface.

**a:** Screw nuts **B** onto the end of short threaded studs **A**.

**b:** Screw short threaded studs **A** into the metal discs on the underside of glass top **1**.

Use spanner **C** to fully tighten nuts **B** down onto the metal discs.

**c:** Screw legs **2** onto the threaded studs and tighten.

**Note:** Take care not to overtighten.

With help, carefully turn the table upright.



**Warning:**

The table is heavy. Lift with care.

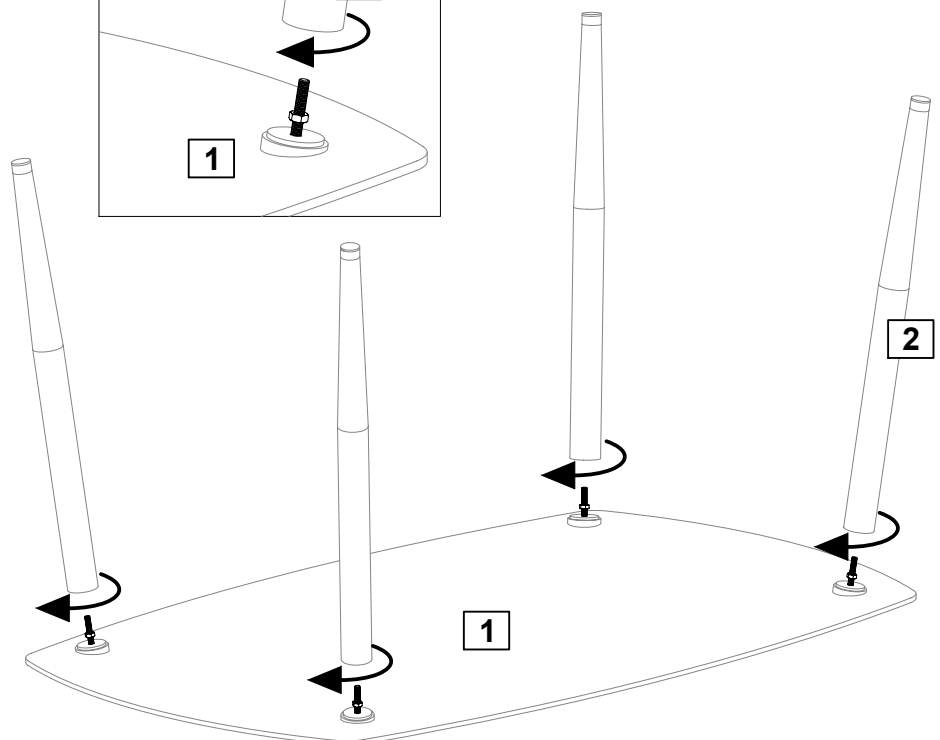
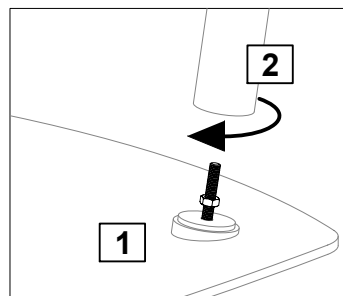
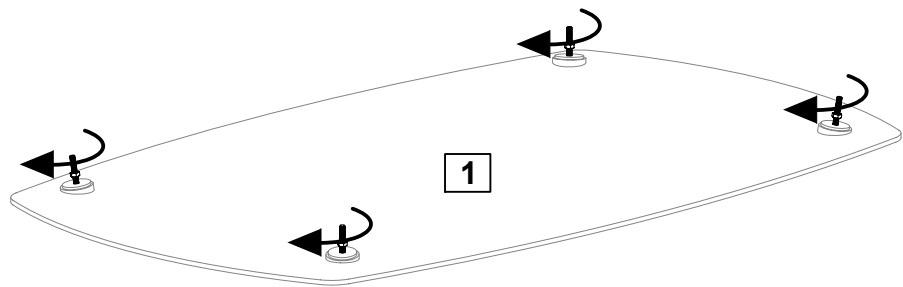
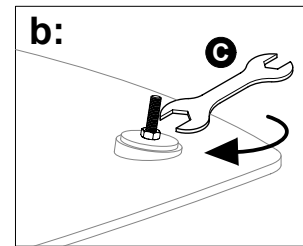
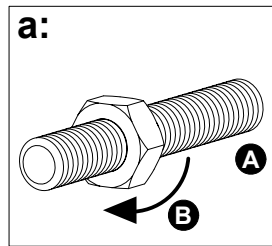

**Assembly is complete.**

If you need help or have damaged or missing parts, call the **Customer Helpline: 08456 400800**  
Home Retail Group, 489-499 Avebury Boulevard, Saxon Gate West, Central Milton Keynes, MK9 2NW