

Dining Chair

Assembly Instructions - Please keep for future reference

603/1035

603/1059

603/1042

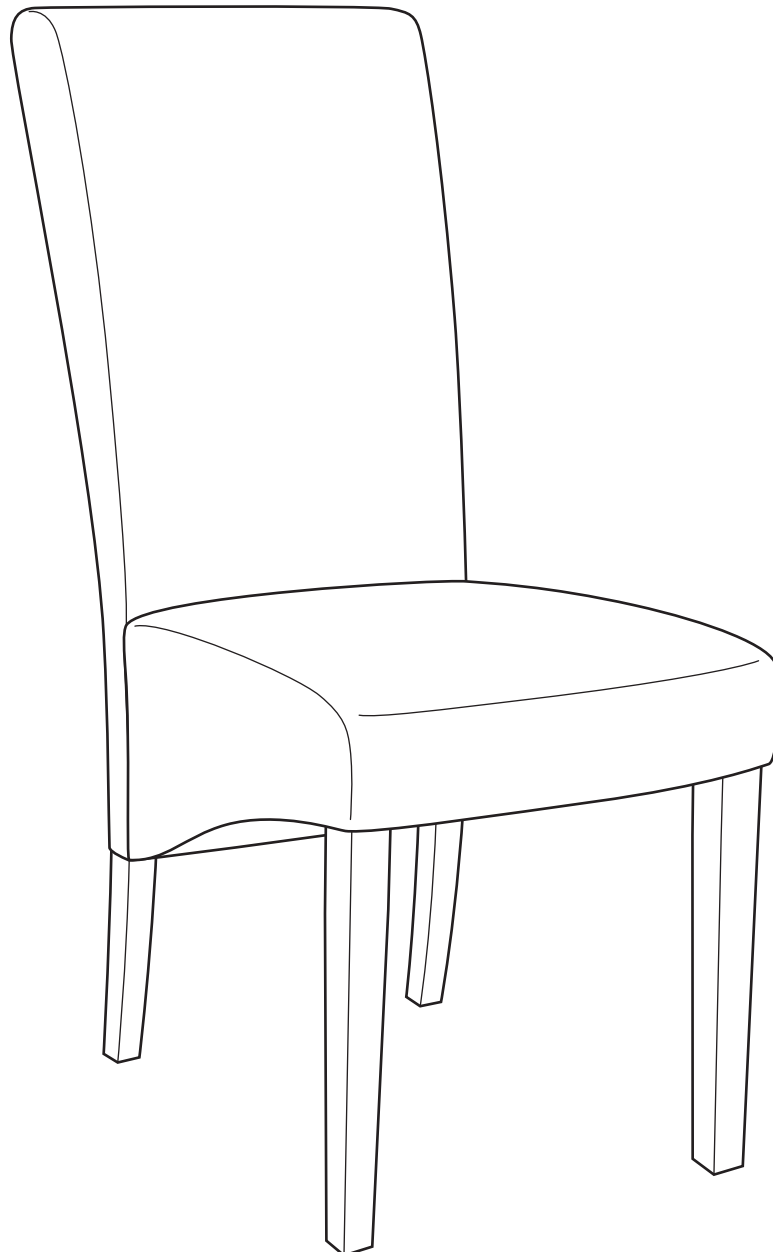

Dimensions

Width - 44cm

Depth - 54cm

Height - 95cm

Important - Please read these instructions fully before starting assembly

If you need help or have damaged or missing parts, call the **Customer Helpline: 08456 400800**



Safety and Care Advice

Important - Please read these instructions fully before starting assembly

- Assemble this product on a flat surface.
- Assemble all parts loosely before tightening any bolts.
- Do not discard any of the packaging until you have checked that you have all the parts and the pack of fittings.

- Discard all extra fittings and keep fittings out of reach of children.
- Unit weight: 5.4kgs.
- Maximum safe weight of user: 110kgs.
- Retain Assembly Instructions for future reference.



- We do not recommend the use of power drill/drivers **for inserting screws**, as this could damage the unit. Only use hand screwdrivers.
- Dispose of all packaging carefully and responsibly.

Warnings

- This product should only be used on firm, level ground.
- Make sure the legs remain in contact with the ground.
- Do not stand on the product.

Care and maintenance

- Please clean the unit surface using either damp (not wet) cloth and a mild domestic soap solution or by using an appropriate polish.
- Do not use any abrasive materials when cleaning.
- From time to time check that there are no loose bolts on this unit.

Components - Parts

If you have damaged or missing components, call the **Customer Helpline: 08456 400800**

Please check you have all the parts listed below

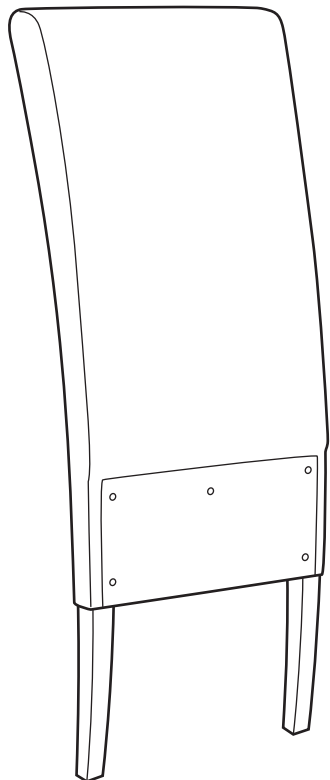

1 Backrest
(36 x 10 x 95cm)

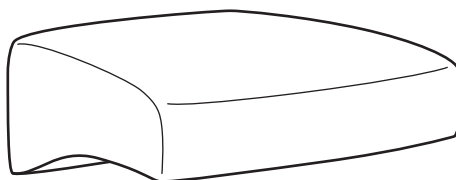

2 Seat
(43.5 x 41.5 x 17.5cm)

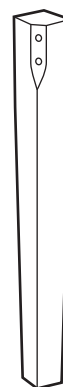

3 Leg x 2
(43 x 3 x 3cm)

Components - Fittings

Please check you have all the fittings listed below

Note: The quantities below are the correct amount to complete the assembly. In some cases more fittings may be supplied than are required.

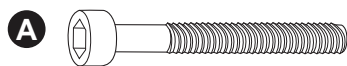

M8 x 60mm Bolt x 9



Spring washer x 9



Washer x 9



Allen key x 1

Ruler - Use this ruler to help correctly identify the screws

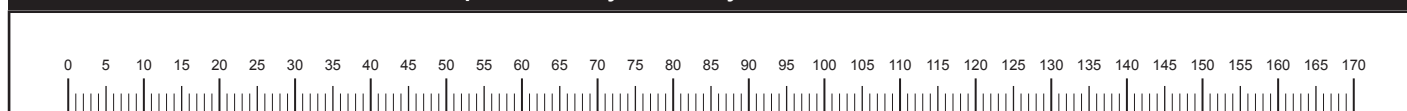

Assembly Instructions

Step 1

Attaching legs

Place the seat **2** upside down on a flat protected surface.

Insert the legs **3** into the holes of the seat as shown and fix using bolts **A**, spring washer **B** and washers **C**.



Important:

Fasten bolts using allen key **D** but do not fully tighten at this stage.

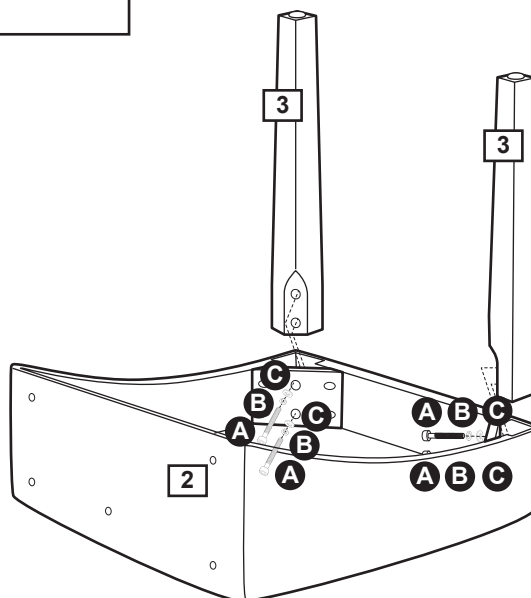
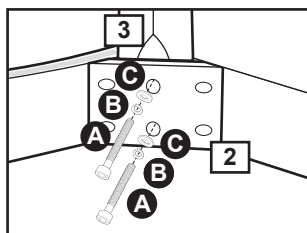

Step 2

Attaching backrest

Place the backrest on a flat protected surface.

Position the seat **2** on the backrest **1** as shown and fix using bolts **A**, spring washers **B** and washers **C**.



Important:

Fasten bolts using allen key **D** but do not fully tighten at this stage.

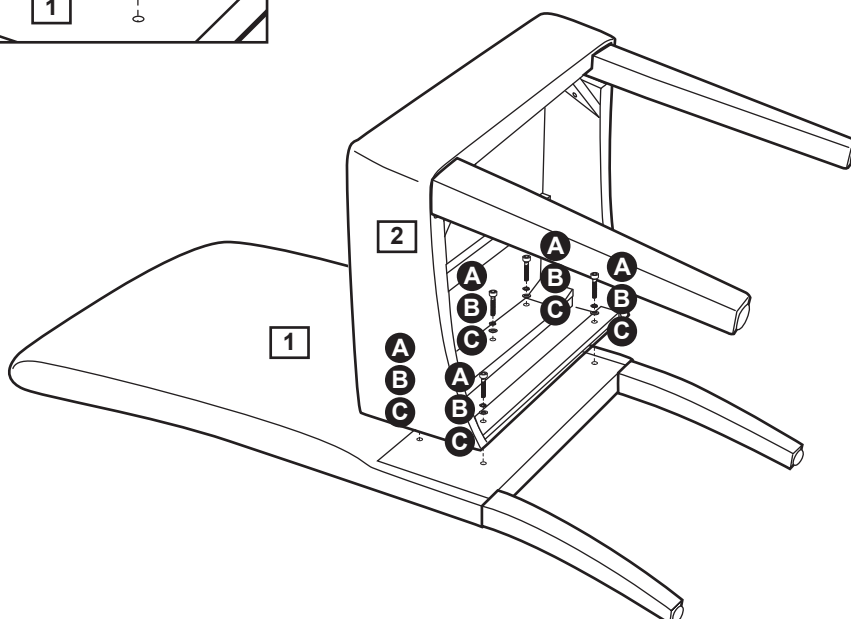
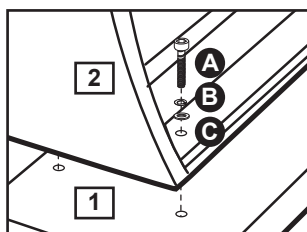

Assembly Instructions

Step 3

Aligning & securing the legs

Carefully turn the chair upright and place on a flat surface.

a: Tighten all bolts using allen key **D**.

Note: This step is essential to prevent the chair from wobbling due to uneven legs.

b: Carefully sit on the chair and make adjustments to ensure the legs are flat even on the floor.

c: After the sitting test, re-tighten bolts again if any adjustment is needed.

Note: It is highly recommended to re-tighten all bolts after using the chair for 7 days.

Note: Keep allen key to re-tighten bolts when required.

Assembly is complete.

a:

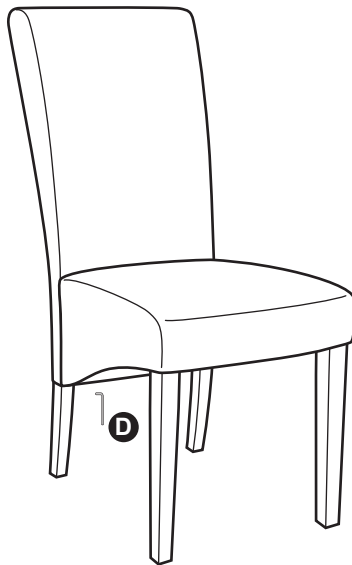

b:

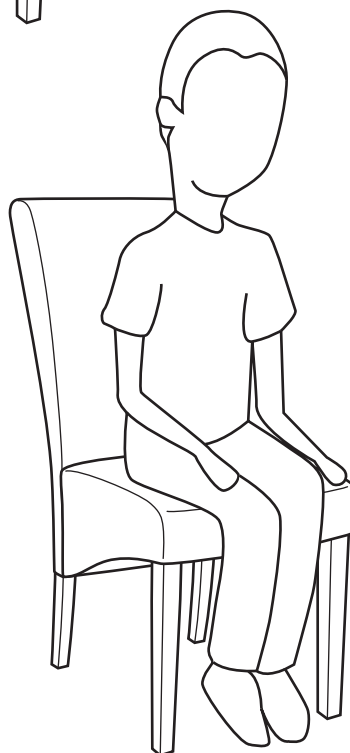

c:

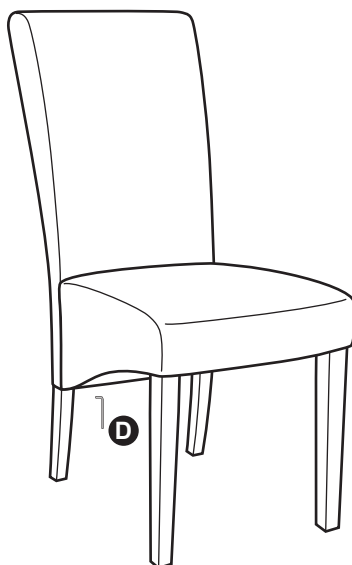

If you need help or have damaged or missing parts, call the **Customer Helpline: 08456 400800**

Dining Chair

Assembly Instructions - Please keep for future reference

603/7792

603/7826

603/1035

603/1059

603/1042

603/7802

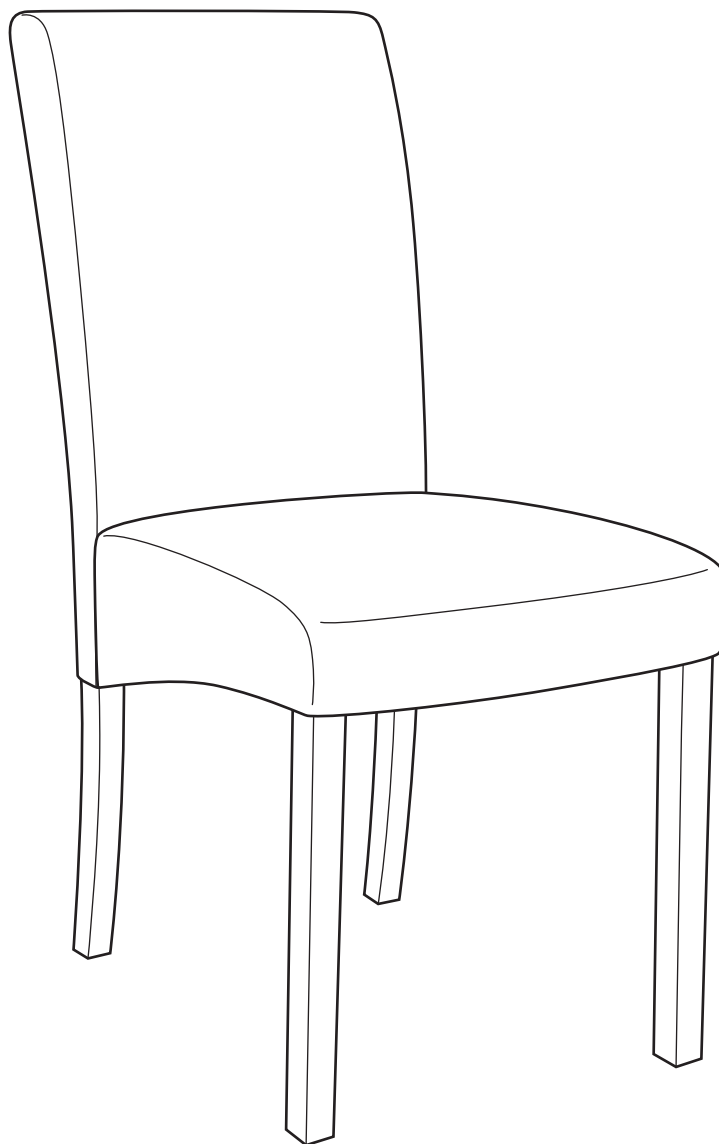

Dimensions

Width - 43.5cm

Depth - 56cm

Height - 95cm

Important - Please read these instructions fully before starting assembly

If you need help or have damaged or missing parts, call the **Customer Helpline: 08456 400800**



Safety and Care Advice

Important - Please read these instructions fully before starting assembly

- Assemble this product on a flat surface.
- Assemble all parts loosely before tightening any bolts.
- Do not discard any of the packaging until you have checked that you have all the parts and the pack of fittings.

- Discard all extra fittings and keep fittings out of reach of children.
- Unit weight: 5.2kgs.
- Maximum safe weight of user: 110kgs.
- Retain Assembly Instructions for future reference.



- We do not recommend the use of power drill/drivers **for inserting screws**, as this could damage the unit. Only use hand screwdrivers.
- Dispose of all packaging carefully and responsibly.

Warnings

- This product should only be used on firm, level ground.
- Make sure the legs remain in contact with the ground.
- Do not stand on the product.

Care and maintenance

- Please clean the product using either damp (not wet) cloth and a mild domestic soap solution or by using an appropriate polish.
- Do not use any abrasive materials when cleaning.
- From time to time check that there are no loose bolts on this unit.

Components - Parts

If you have damaged or missing components, call the **Customer Helpline: 08456 400800**

Please check you have all the parts listed below

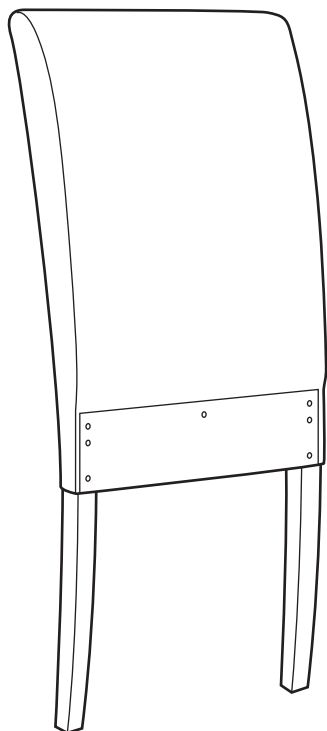

1 Backrest
(36 x 10 x 95cm)

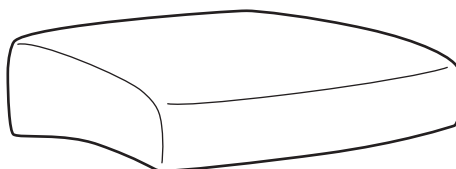

2 Seat
(43.5 x 41.5 x 17cm)



3 Leg x 2
(3 x 3 x 43cm)

Components - Fittings

Please check you have all the fittings listed below

Note: The quantities below are the correct amount to complete the assembly. In some cases more fittings may be supplied than are required.

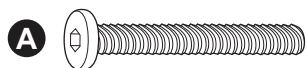

A M6 x 50mm Bolt x 11



B Spring washer x 11



C Flat washer x 11



D Allen key x 1

Ruler - Use this ruler to help correctly identify the screws

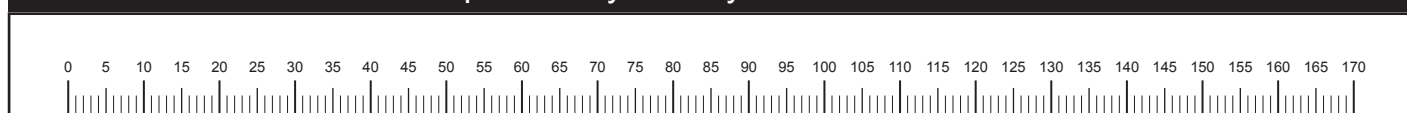

Assembly Instructions

Step 1

Attaching legs

Place the seat **2** upside down on a flat protected surface.

Insert the legs **3** into the holes of the seat as shown and fix using bolts **A**, spring washers **B** and washers **C**.



Important:

Fasten bolts using allen key **D** but do not fully tighten at this stage.

Note:

Use oval head of allen key **D** on tight angles.

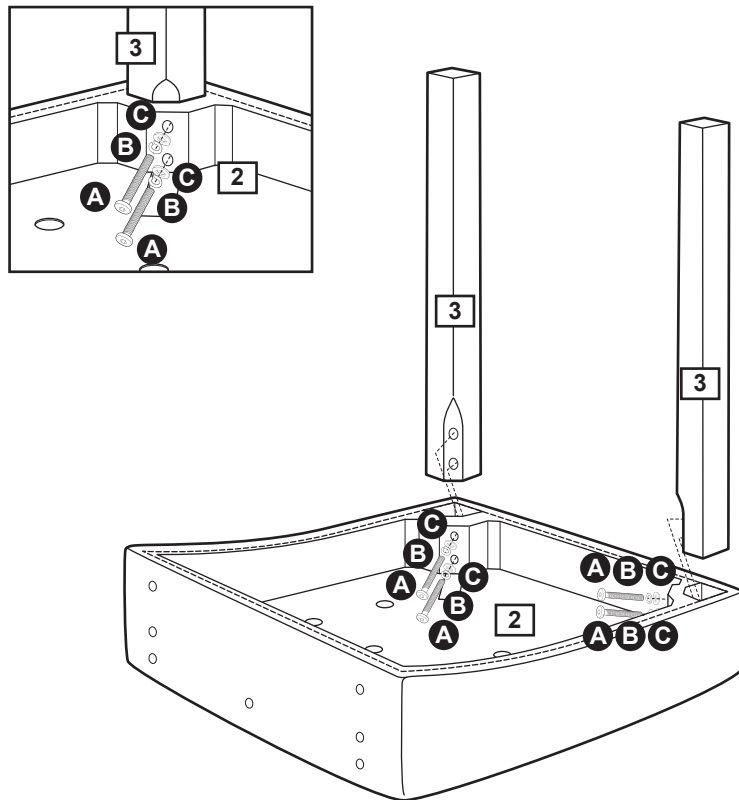

Step 2

Attaching backrest

Place the backrest on a flat protected surface.

Position the seat **2** on the backrest **1** as shown and fix using bolts **A**, spring washers **B** and washers **C**.



Important:

Fasten bolts using allen key **D** but do not fully tighten at this stage.

Note:

Use oval head of allen key **D** on tight angles.

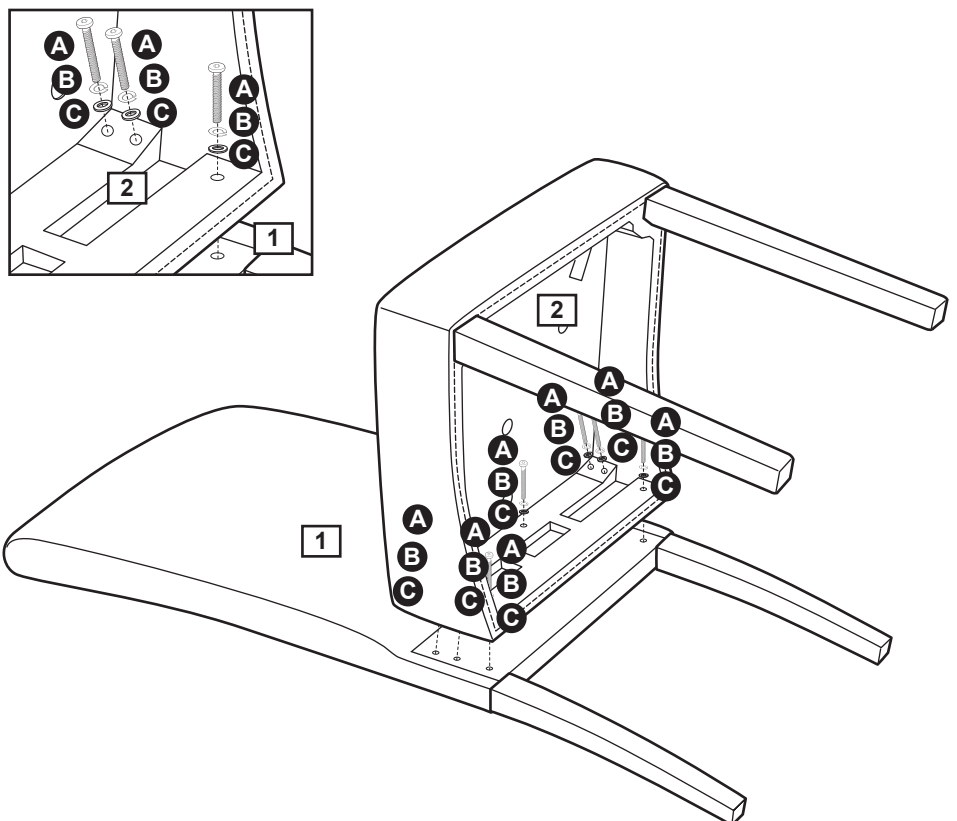

Assembly Instructions

Step 3

Aligning & securing the legs

Carefully turn the chair upright and place on a flat surface.

a: Tighten all bolts using allen key **D**.

Note: Use oval head of allen key **D** on tight angles.

Note: This step is essential to prevent the chair from wobbling due to uneven legs.

b: Carefully sit on the chair and make adjustments to ensure the legs are flat even on the floor.

c: After the sitting test, re-tighten bolts again if any adjustment is needed.

Note: It is highly recommended to re-tighten all bolts after using the chair for 7 days.

Note: Keep allen key to re-tighten bolts when required.

Assembly is complete.

a:

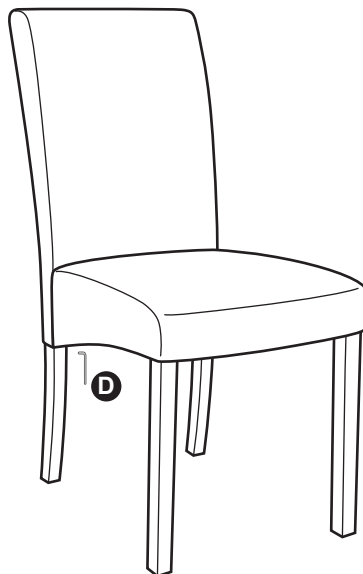

b:



c:

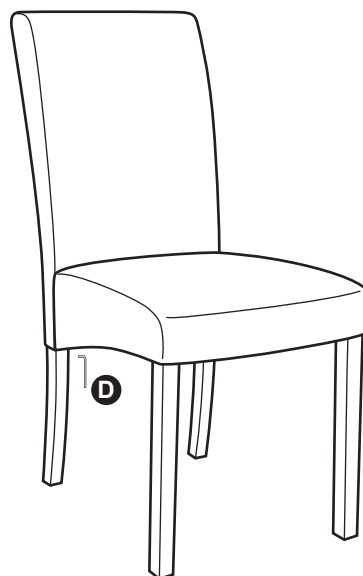

If you need help or have damaged or missing parts, call the **Customer Helpline: 08456 400800**

Dining Chair

Assembly Instructions - Please keep for future reference

603/1042

603/1059

603/1035

603/1767

603/1798

603/3923

603/3930

603/3947

603/3954

632/1161

632/1178

468657

1863916

1863909

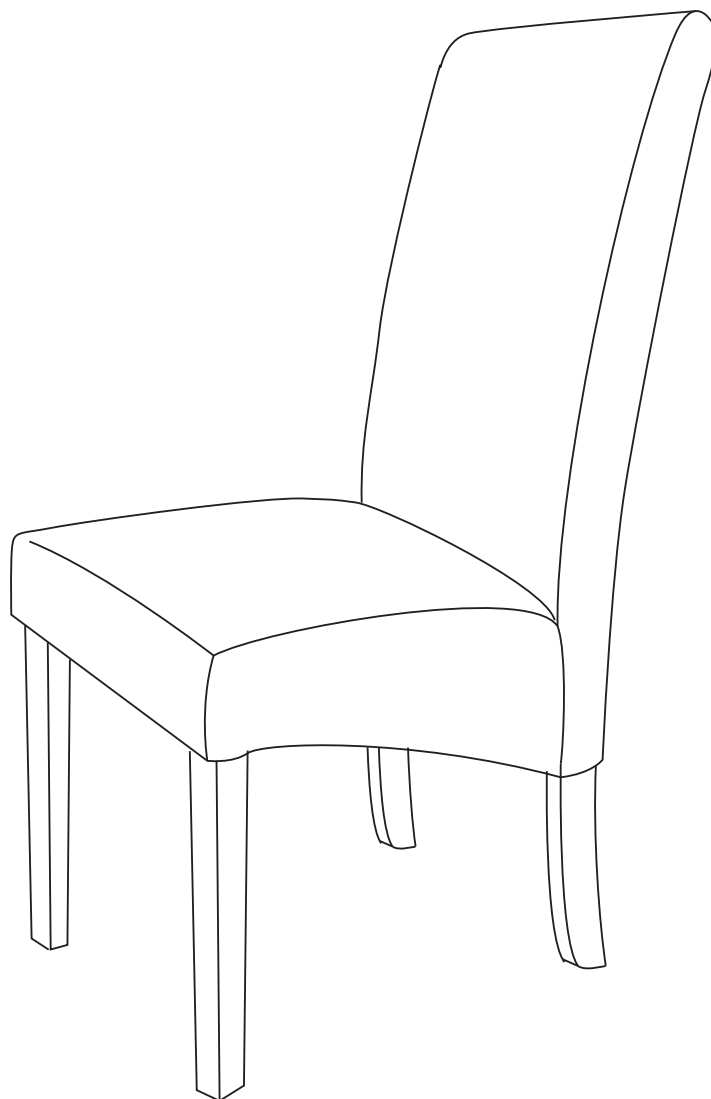

Dimensions

Width - 43.5cm

Deep - 55cm

Height - 96cm

Important Please read these instructions fully before starting assembly

If you need help or have damaged or missing parts, call the Customer Helpline: 0845 6400 800



Safety and Care Advice

Important Please read these instructions fully before starting assembly

- Check you have all the components and tools listed on pages 2 and 3.
- Remove all fittings from the plastic bags and separate them into their groups.
- Keep children and animals away from the work area, small parts could choke if swallowed.
- Make sure you have enough space to layout the parts before starting.

- Do not stand or put weight on the product, this could cause damage.
- Assemble the item as close to its final position (in the same room) as possible.
- Assemble on a soft level surface to avoid damaging the unit or your floor.
- Parts of the assembly will be easier with 2 people.



- We do not recommend the use of power drill/drivers **for inserting screws**, as this could damage the unit. Only use hand screwdrivers.
- Dispose of all packaging carefully and responsibly.

Care and maintenance

- Only clean using a damp cloth and mild detergent, do not use bleach or abrasive cleaners.
- From time to time check that there are no loose screws on this unit.
- This product should not be discarded with household waste. Take to your local authority waste disposal centre.

Components Panels

Please check you have all the panels listed below

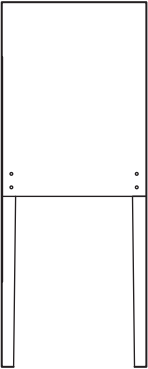

1 Back frame (3x6 6cm)



2 Leg x 23 x 24cm)

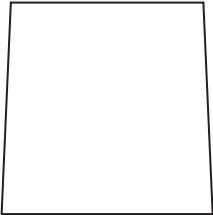

3 Box seat (4 x. 4 cm 5)

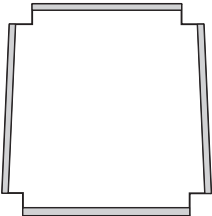





4 Dust Cover 40 x 45cm)

Components - Fittings

If you have damaged or missing components, call the Customer Helpline: 0845 6400 800

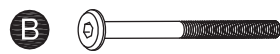
Please check you have all the fittings listed below

Note: The quantities below are the correct amount to complete the assembly. In some cases more fittings may be supplied than are required.

 <p>A</p> <p>M6x85mm Bolt x 8</p>	 <p>B</p> <p>M6x55mm Bolt x 10</p>	 <p>C</p> <p>Ø18x1mm Washer x 18</p>
 <p>D</p> <p>Ø11x1.5mm Spring washer x 16</p>	 <p>E</p> <p>4mm Hex Key x 1</p>	

Tools required

Ruler - Use this ruler to help correctly identify the screws

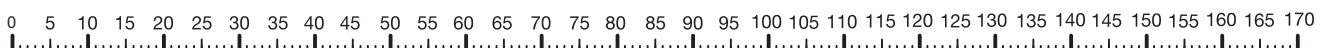

Assembly Instructions

Step 1

Dust Cover

Remove the dust cover **4**

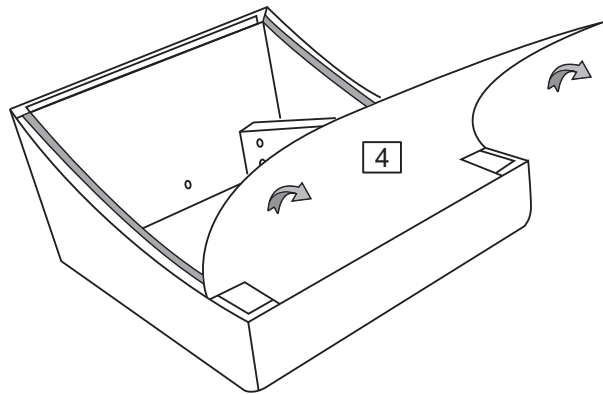

Step 2

Fitting legs

Locate the corners of the box seat opposite to the center hole.

Insert the legs **2** into the corners of the box seat **3**.

Assemble bolts **B**, spring washers **D** and washers **C** through each corner block of the box seat **3** using hex key **E**.

Tighten the bolts.

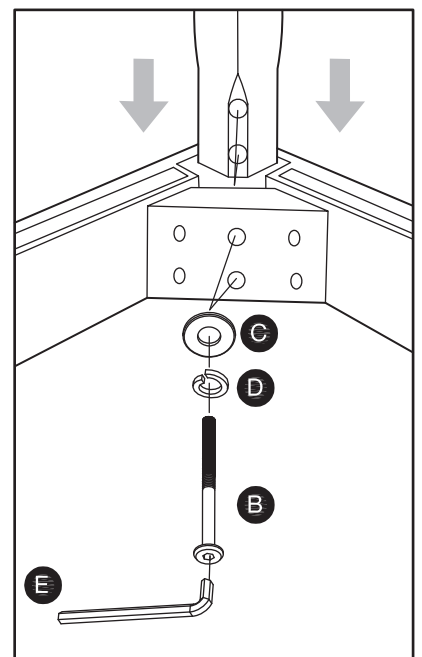
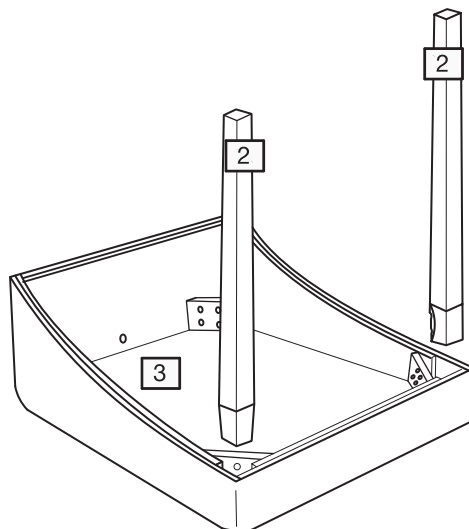

Assembly Instructions

Step 3

Attaching back frame

Place the box seat **3** on the back frame **1**. Assemble the bolt **B** and washer **C** onto the back frame **1** using hex key **E**.

Do not tighten the bolts at this point.

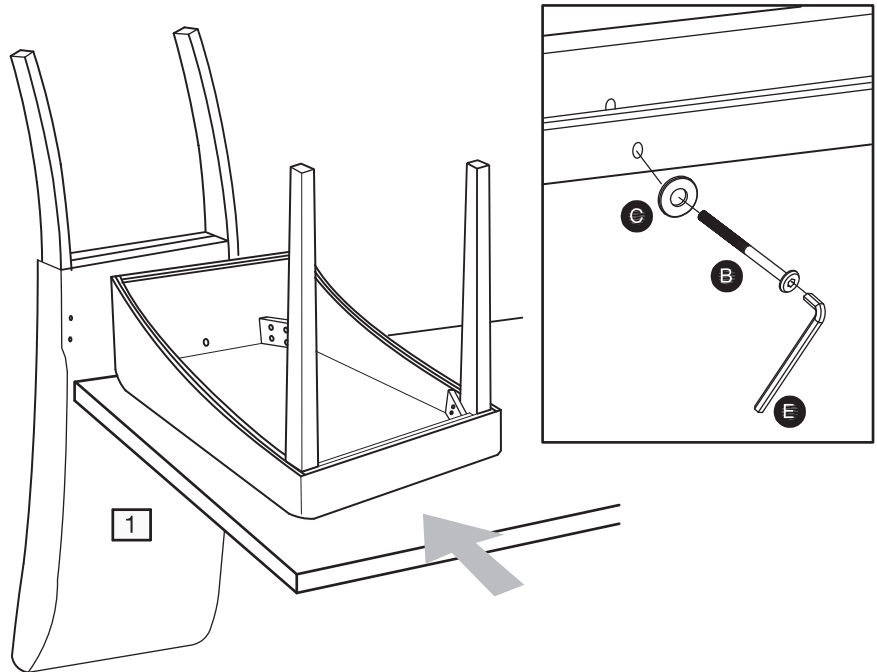

Step 4

Fitting bolts

Assemble bolts **A**, spring washers **D** and washers **C** through each corner block of the box seat **3** to the back frame

Do not tighten the bolts at this point in time.

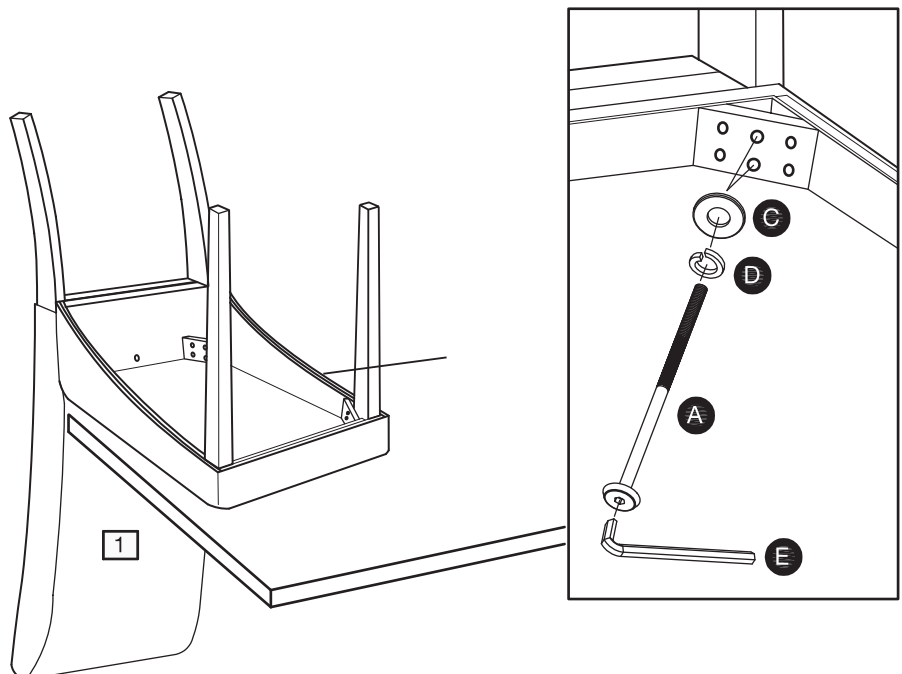

Assembly Instructions

Step 5

Carefully turn the chair over, and put the chair on the floor

Step 6

Tighten each loose bolt a little at a time while making sure the chair remains level. Repeat until all loose bolts are tight.

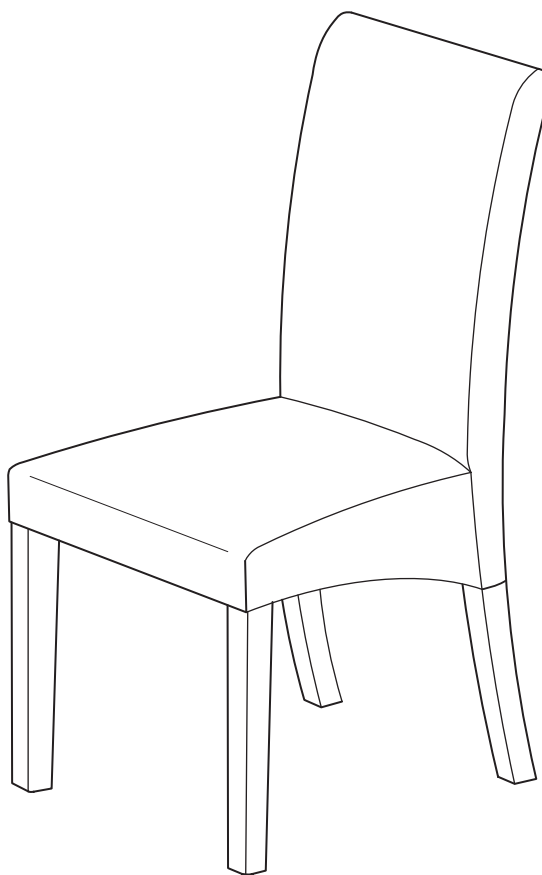

Step 7

Attach back the dust cover

4

Repeat with remaining chairs.

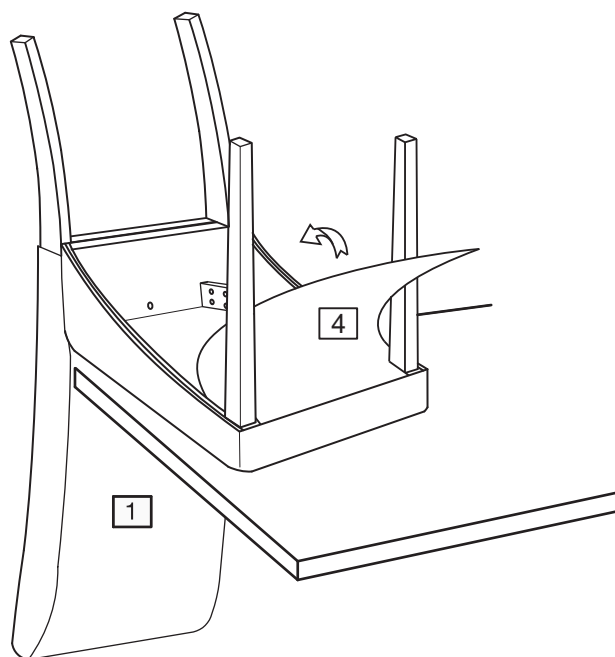

Wow Madison Table

Assembly Instructions - Please keep for future reference

633/3221

633/3386

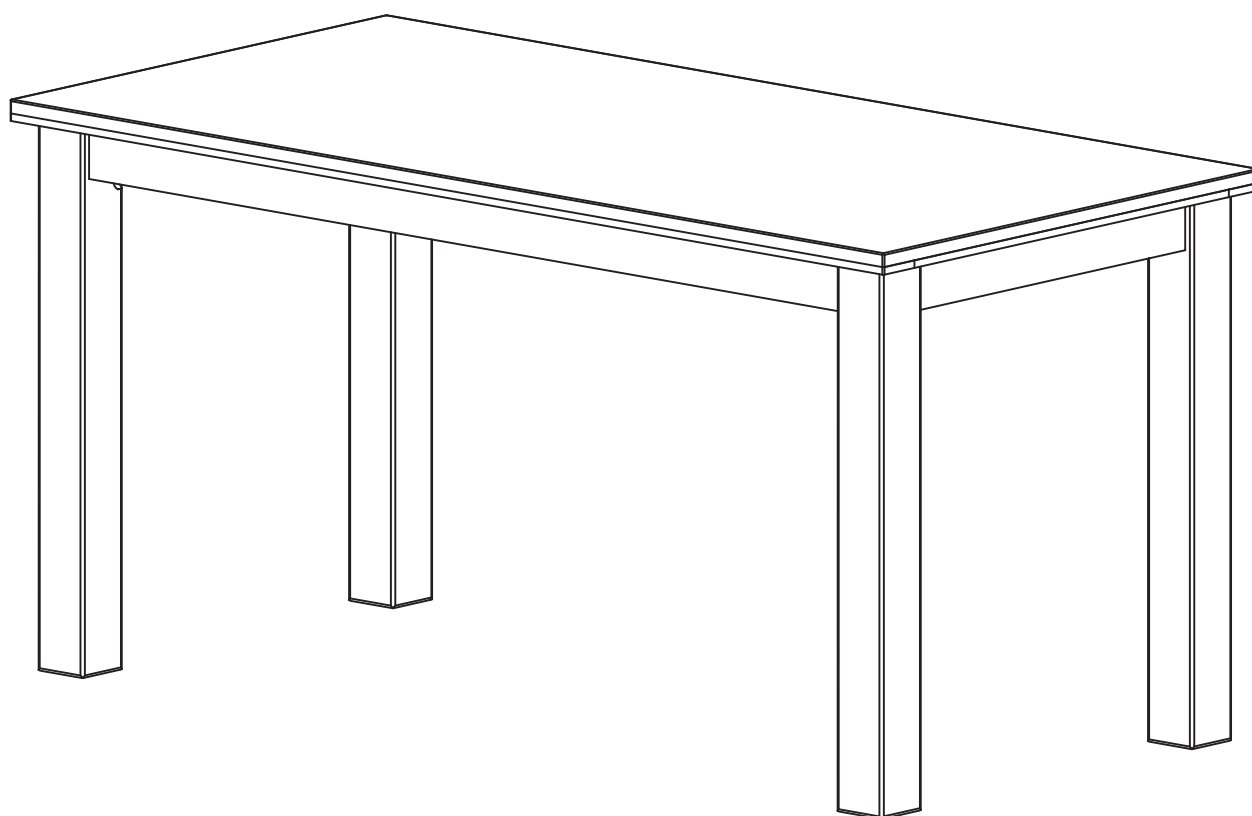

Dimensions

Length - 150cm

Width - 73cm

Height - 75cm

Important – Please read these instructions fully before starting assembly

If you need help or have damaged or missing parts, call the **Customer Helpline: 0845 640 0800**



Safety and Care Advice

Important – Please read these instructions fully before starting assembly

- Check you have all the components and tools listed on pages 2 and 3.
- Remove all fittings from the plastic bags and separate them into their groups.
- Keep children and animals away from the work area, small parts could choke if swallowed.
- Make sure you have enough space to layout the parts before starting.

- Do not stand or put weight on the product during assembly, this could cause damage.
- Assemble the item as close to its final position (in the same room) as possible.
- Assemble on a soft level surface to avoid damaging the unit or your floor.
- Parts of the assembly will be easier with 2 people.



• We do not recommend the use of power drill/drivers **for inserting screws**, as this could damage the unit. Only use hand screwdrivers.

- Dispose of all packaging carefully and responsibly.

Care and maintenance

- Only clean using a damp cloth and mild detergent, do not use bleach or abrasive cleaners.
- From time to time check that there are no loose screws on this unit.
- This product should not be discarded with household waste. Take to your local authority waste disposal centre.

Components - Panels

If you have damaged or missing components, call the **Customer Helpline: 0845 640 0800**

Please check you have all the panels listed below

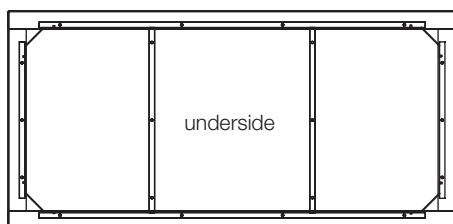





2 Leg x 4 (7.8 x 72.2cm)

1 Top (150 x 73cm)

Components - Fittings

Please check you have all the fittings listed below

Note: The quantities below are the correct amount to complete the assembly. In some cases more fittings may be supplied than are required.

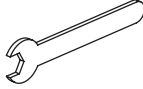
A  70mm Bolt x 8	B  Assembly bolt x 4	C  Washer x 8
D  13mm Nut x 8	E  Spring washer x 8	F  13mm Spanner x 1

Tools required

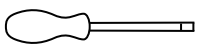

Phillips screwdriver
(medium)



Ruler/tape
measure

Ruler - Use this ruler to help correctly identify the screws

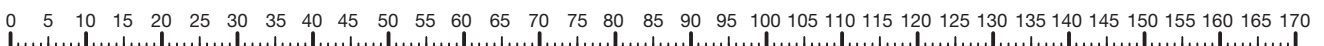

Assembly Instructions

Step 1

Fitting bolts

Insert assembly bolt **B** into leg **2**. Screw bolts **A** into assembly bolt **B**.

Repeat with remaining legs **2**.

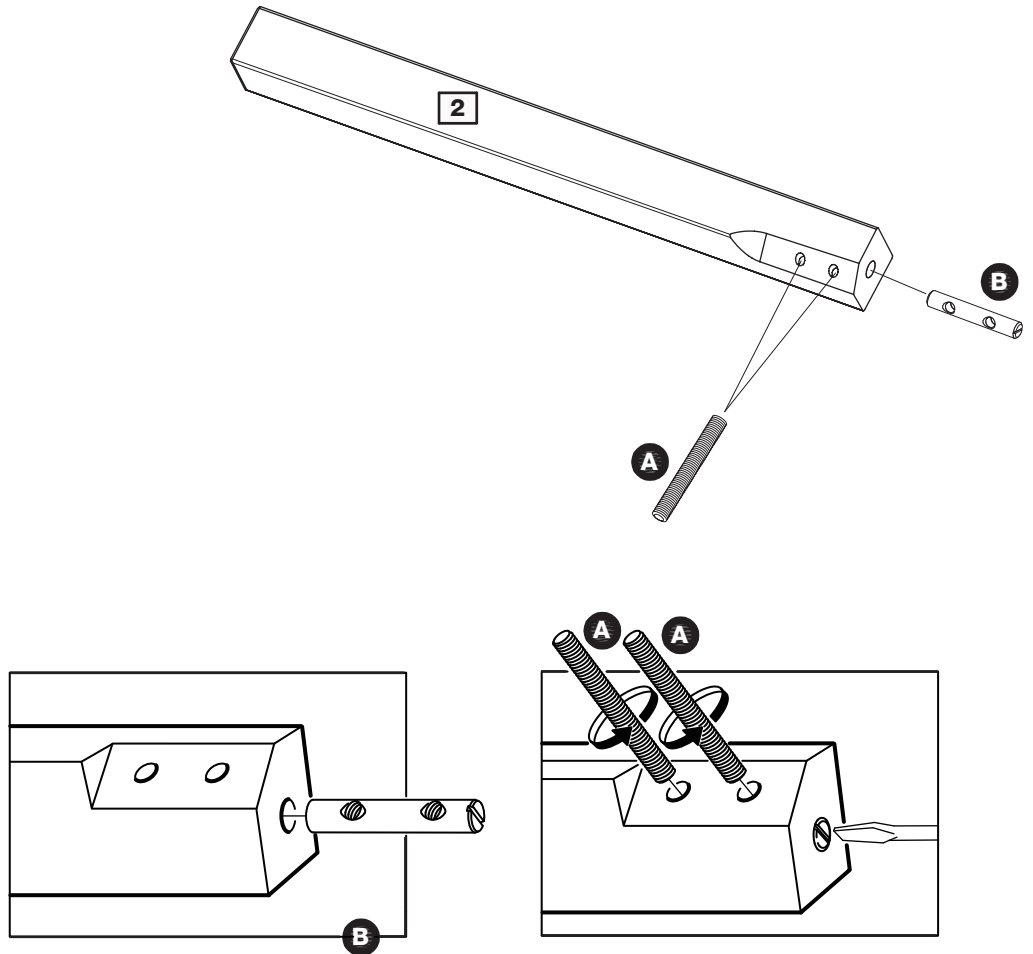

Step 2

Attaching legs

Attach the four pieces of legs **2** to top **1** using washer **C**, spring washer **E** and nut **D**. Tighten the bolts with spanner **F**.

With help, turn the table over carefully.

Assembly is complete.

