

Dining Chair

Assembly Instructions - Please keep for future reference

600/1584

603/2364

603/0452

600/3654

160/609

603/0830

603/2333

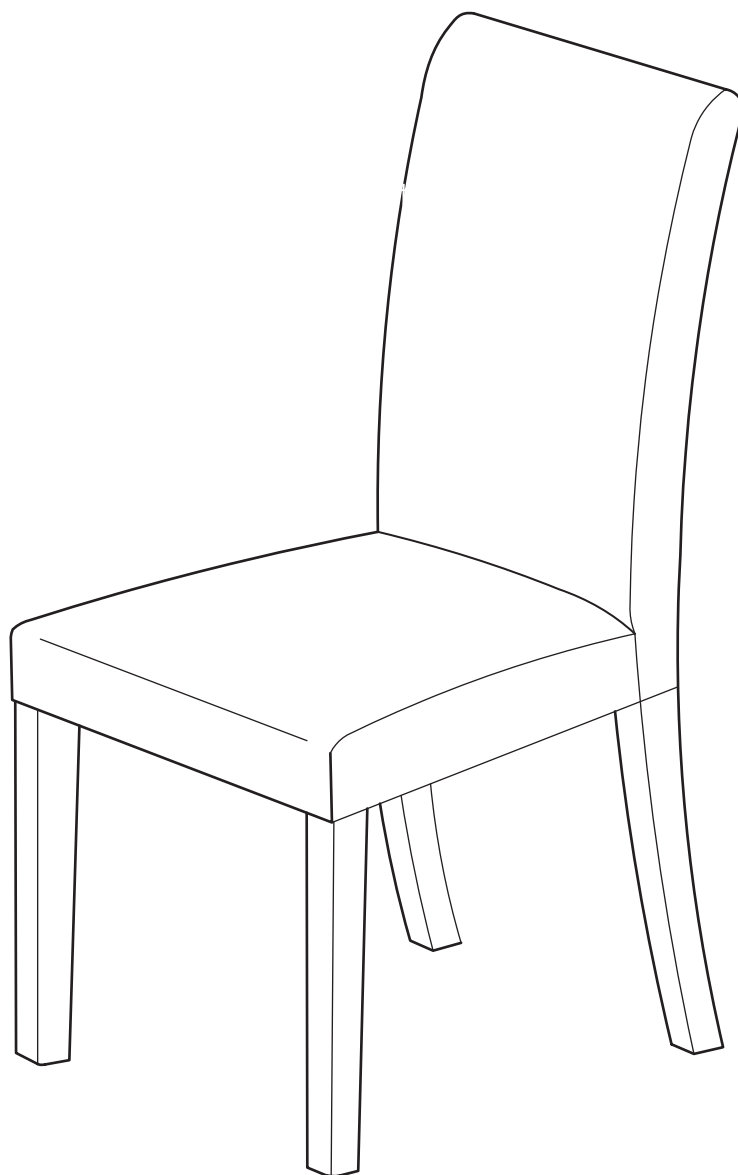

Dimensions

Width - 43.5cm

Deep - 52.5cm

Height - 92cm

Important Please read these instructions fully before starting assembly

If you need help or have damaged or missing parts, call the **Customer Helpline: 0845 640 0800**



afety and Care Advice

Important Please read these instructions fully before starting assembly

- Check you have all the components and tools listed on pages and .
- Remove all fittings from the plastic bags and separate them into their groups.
- Keep children and animals away from the work area, small parts could choke if swallowed.
- Make sure you have enough space to layout the parts before starting.

- Do not stand or put weight on the product, this could cause damage.
- Assemble the item as close to its final position (in the same room as possible.
- Assemble on a soft level surface to avoid damaging the unit or your oor.
- Parts of the assembly will be easier with people.



- We do not recommend the use of power drill drivers **for inserting screws**, as this could damage the unit. Only use hand screwdrivers.
- Dispose of all packaging carefully and responsibly.

Care and maintenance

- Only clean using a damp cloth and mild detergent, do not use bleach or abrasive cleaners.
- From time to time check that there are no loose screws on this unit.
- This product should not be discarded with household waste. Take to your local authority waste disposal centre.

Components - Panels

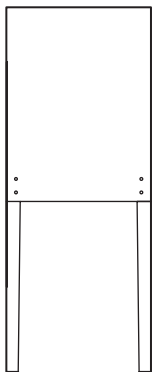

1 Back frame (36.5 x 92cm)

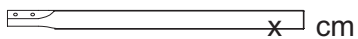

2 Leg x 2 (3.2 43)

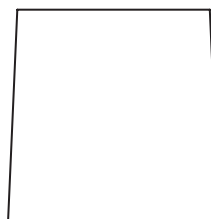



3 Box seat (43.5 x 41.5cm)

Components - Fittings

If you have damaged or missing components, call the **Customer Helpline: 0845 640 0800**

Please check you have all the fittings listed below

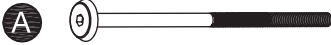
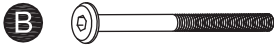
Note: The quantities below are the correct amount to complete the assembly. In some cases more fittings may be supplied than are required.

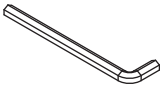
 <p>A</p> <p>M6x85mm Bolt x 8</p>	 <p>B</p> <p>M6x55mm Bolt x 10</p>	 <p>C</p> <p>Ø18x1mm Washer x 18</p>
 <p>D</p> <p>Ø11x1.5mm Spring washer x 16</p>	 <p>E</p> <p>4mm Hex Key x 1</p>	

Tools required



Ruler/tape
measure

Ruler - Use this ruler to help correctly identify the screws

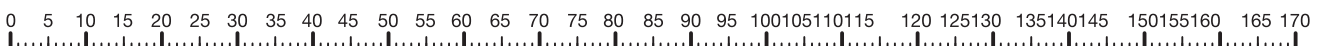

Assembly Instructions

Step 1

Fitting legs

Locate the corners of the box seat opposite to the center hole.

Insert the legs **2** into the corners of the box seat **3**.

Assemble bolts **B**, spring washers **D** and washers **C** through each corner block of the box seat **3** using hex key **E**.

Tighten the bolts.

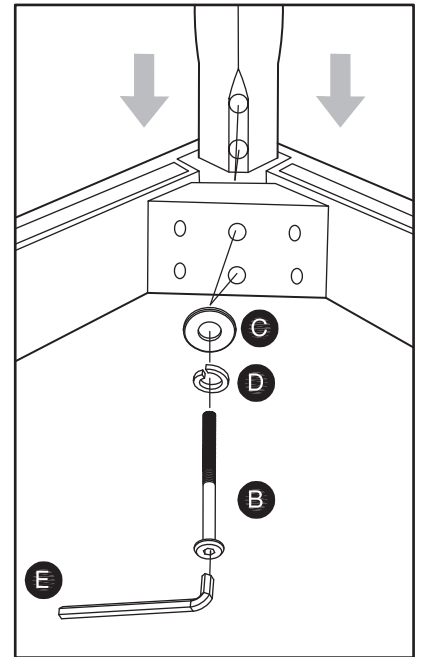
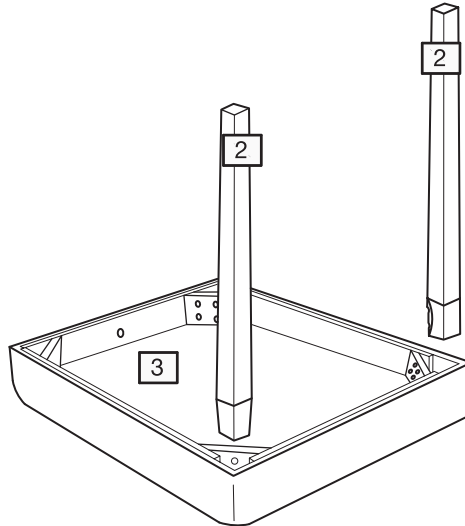

Step 2

Attaching back frame

Place the box seat **3** on the back frame **1**.

Assemble the bolt **B** and washer **C** onto the back frame **1** using hex key **E**.

Do not tighten the bolts at this point.

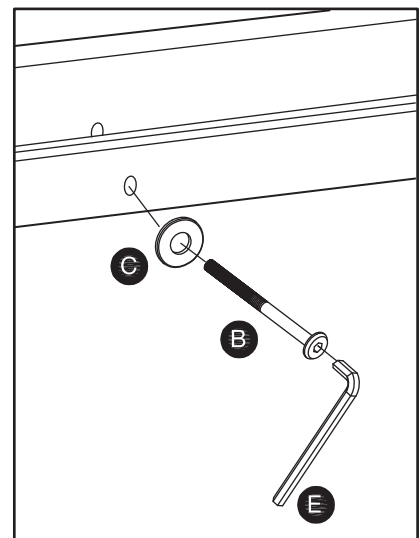
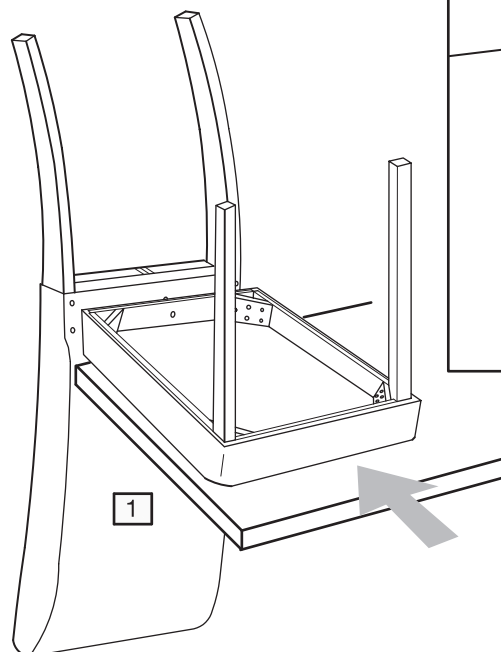

Assembly Instructions

Step 3

Fitting bolts

Assemble bolts **A**, spring washers **D** and washers **C** through each corner block of the box seat **3** to the back frame **1**.

Do not tighten the bolts at this point in time.

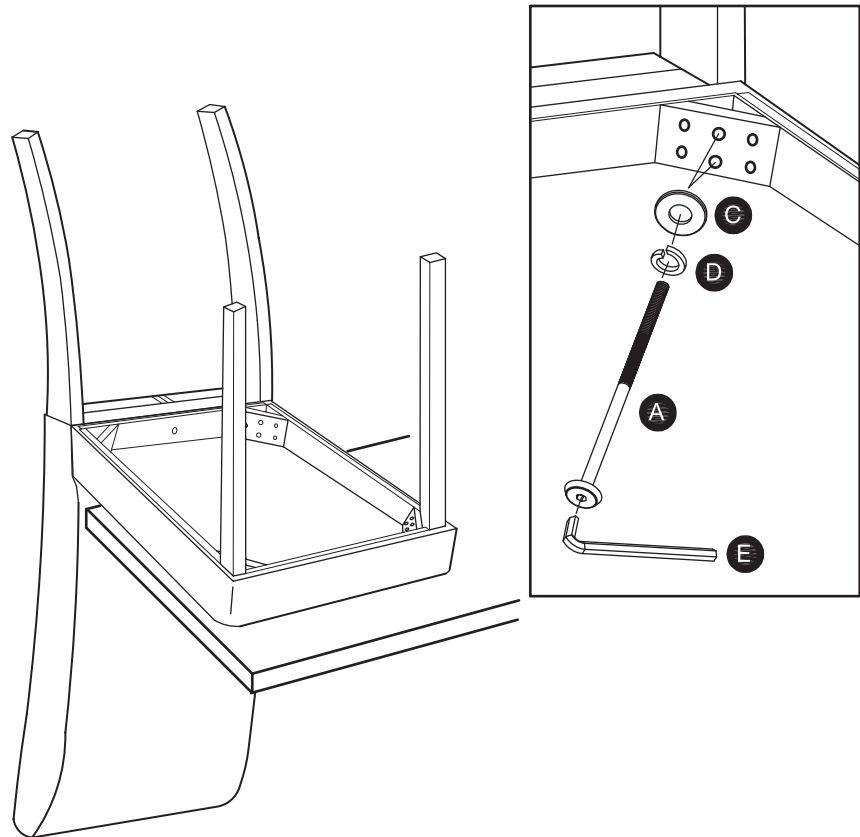

Step 4

Carefully turn the chair over, and put the chair on the oor.

Step 5

Tighten each loose bolt a little at a time while making sure the chair remains level. Repeat until all loose bolts are tight.

Repeat with remaining chairs.

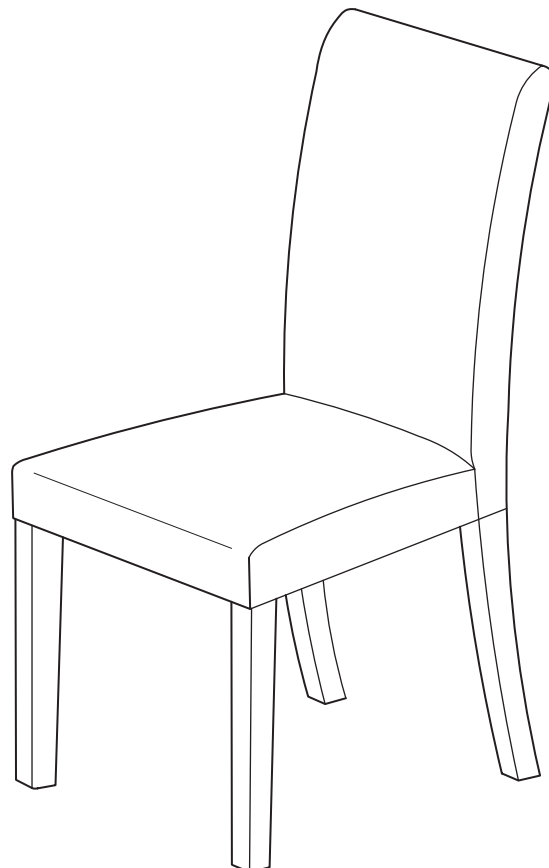

SCHR Eden Oak Veneer Table 150cm

Assembly Instructions - Please keep for future reference

603/5347

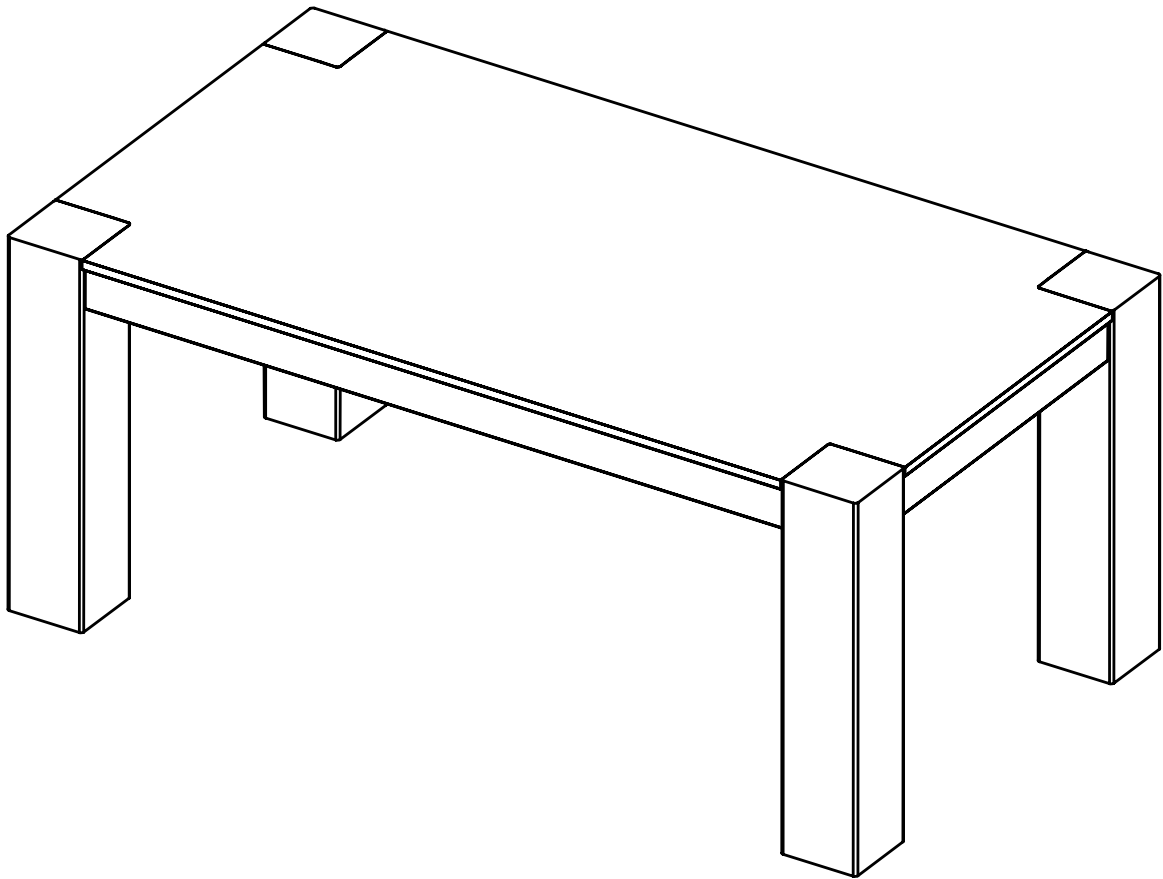

Dimensions

Width - 150cm
Depth - 90cm
Height - 76cm

Important – Please read these instructions fully before starting assembly

If you need help or have damaged or missing parts, call the **Customer Helpline: 0845 640 0800**



Safety and Care Advice

Important – Please read these instructions fully before starting assembly

- Check you have all the components and tools listed on pages 2 and 3.
- Remove all fittings from the plastic bags and separate them into their groups.
- Keep children and animals away from the work area, small parts could choke if swallowed.
- Make sure you have enough space to layout the parts before starting.

- Do not stand or put weight on the product, this could cause damage.
- Assemble the item as close to its final position (in the same room) as possible.
- Assemble on a soft level surface to avoid damaging the unit or your floor.
- Parts of the assembly will be easier with 2 people.



- We do not recommend the use of power drill/drivers **for inserting screws**, as this could damage the unit. Only use hand screwdrivers.
- Dispose of all packaging carefully and responsibly.

Care and maintenance

- Only clean using a damp cloth and mild detergent, do not use bleach or abrasive cleaners.
- From time to time check that there are no loose screws on this unit.
- This product should not be discarded with household waste. Take to your local authority waste disposal centre.

Components - Panels

If you have damaged or missing components, call the **Customer Helpline: 0845 640 0800**

Please check you have all the panels listed below

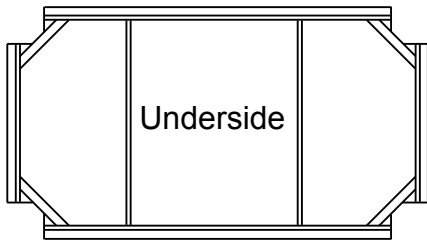

1 Top (150 x 90cm)





2 Leg x 4 (76 x 12cm)

Components - Fittings

Please check you have all the fittings listed below

Note: The quantities below are the correct amount to complete the assembly. In some cases more fittings may be supplied than are required.

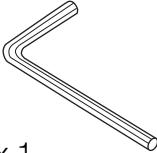
<p>A </p> <p>Bolt x 8 (M8 x 64mm)</p>	<p>B </p> <p>Flat washer x 8</p>	<p>C </p> <p>Spring washer x 8</p>
<p>D </p> <p>Hex key x 1</p>		

Tools required

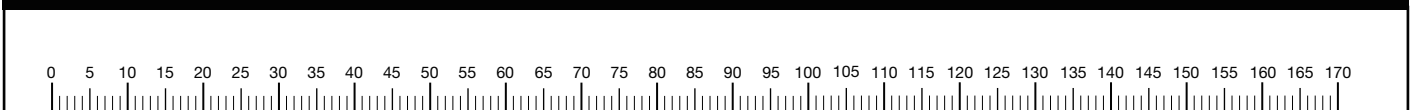

Ruler - Use this ruler to help correctly identify the screws









Assembly Instructions

Step 1

Attaching legs

Match the legs and table top corners by the symbols  & .

Attach four legs  to top  using washer  spring washer  and bolt . Tighten the bolts with hex key .

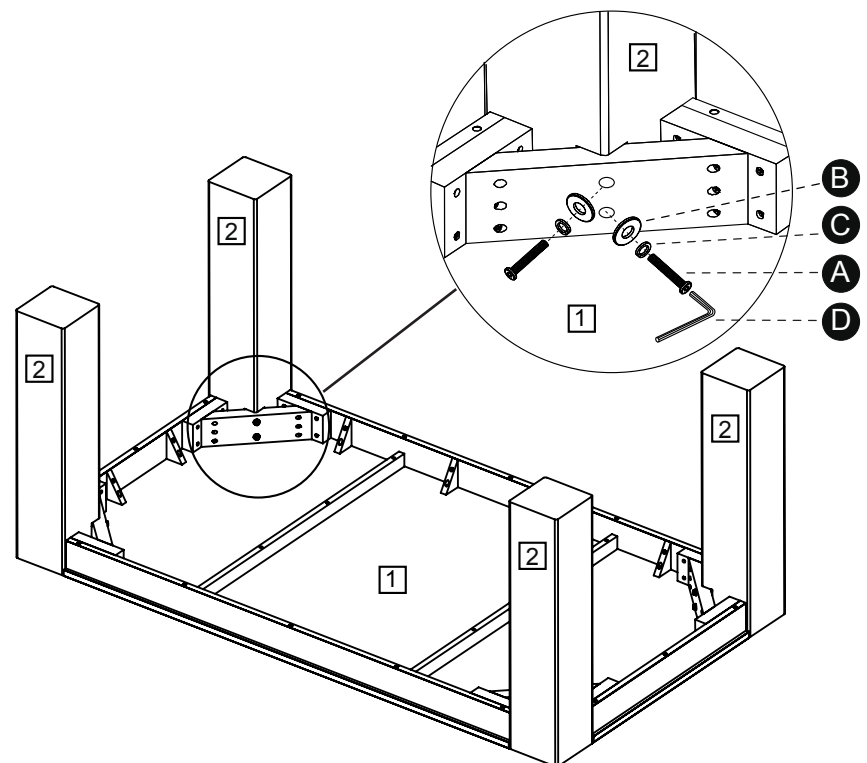
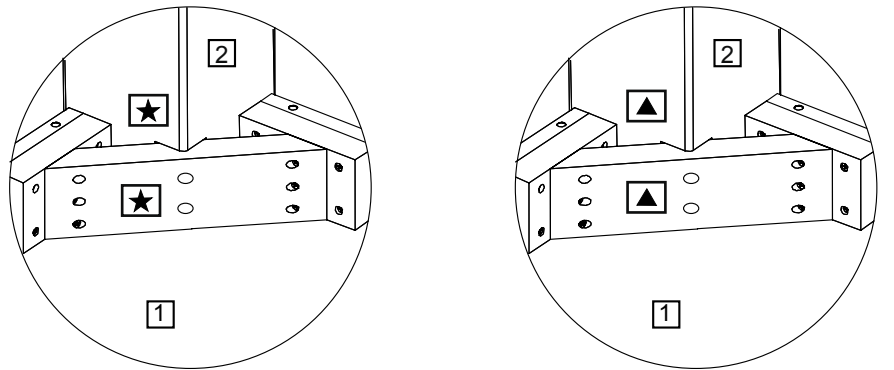

Step 2

Turn the table over carefully.

Assembly is complete.

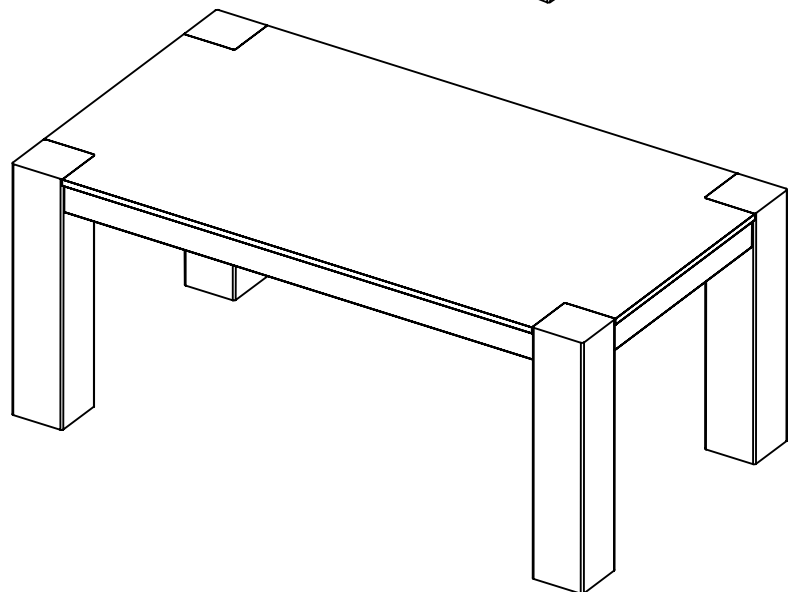

If you need help or have damaged or missing parts, call the **Customer Helpline: 0845 640 0800**
Argos Ltd MK9 2NW