

Amparo Table

Assembly Instructions - Please keep for future reference

633/3290

633/3300

hygena

633/3283



Dimensions

Width - 85cm

Length - 85cm

Height - 76cm

Important – Please read these instructions fully before starting assembly

If you need help or have damaged or missing parts, call the **Customer Help line: 0845 6400800**



Safety and Care Advice

Important – Please read these instructions fully before starting assembly

- Check you have all the components and tools listed on page 2.

- Remove all fittings from the plastic bags and separate them into their groups.

- Keep children and animals away from the work area, small parts could choke if swallowed.

- Make sure you have enough space to layout the parts before starting.

- Do not stand or put weight on the product, this could cause damage.

- Assemble on a soft level surface to avoid damaging the unit or your floor.



- We do not recommend the use of power drill/drivers **for inserting screws**,

as this could damage the unit. Only use hand screwdrivers.

- Dispose of all packaging carefully and responsibly.

Care and maintenance

- Only clean using a dry cloth, do not use bleach or abrasive cleaners.

- From time to time check that there are no loose screws on this unit.

- This product should not be discarded with household waste. Take to your local authority waste disposal centre.

Components - Panels

If you have damaged or missing components, call the **Customer Helpline: 0845 6400800**

Please check you have all the panels listed below

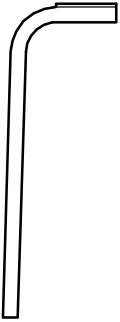

1 Table leg x 4
(74 x 19cm)

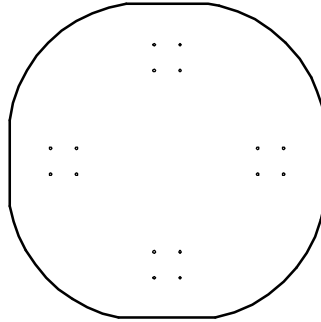

2 Table top (85 x 85cm)

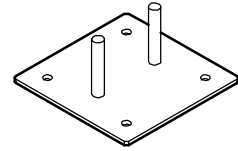



3 Connecting plate x 4
(10 x 10cm)

Components - Fittings

Please check you have all the fittings listed below

Note: The quantities below are the correct amount to complete the assembly. In some cases more fittings may be supplied than are required.

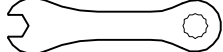
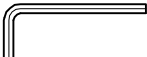
<p>A </p> <p>17mm Bolt x 16</p>	<p>B </p> <p>Nut x 8</p>	<p>C </p> <p>Wrench x 1</p>
<p>D </p> <p>Hex Key X 1</p>		

Assembly Instructions

Step 1

Assemble table top

Place table top **2** upside down on a clean, flat surface.

Fix connecting plate **3** onto the table top using bolts **A** by using Hex key **D**

Note: The direction of the arrows should be pointed outward as shown in the figure.

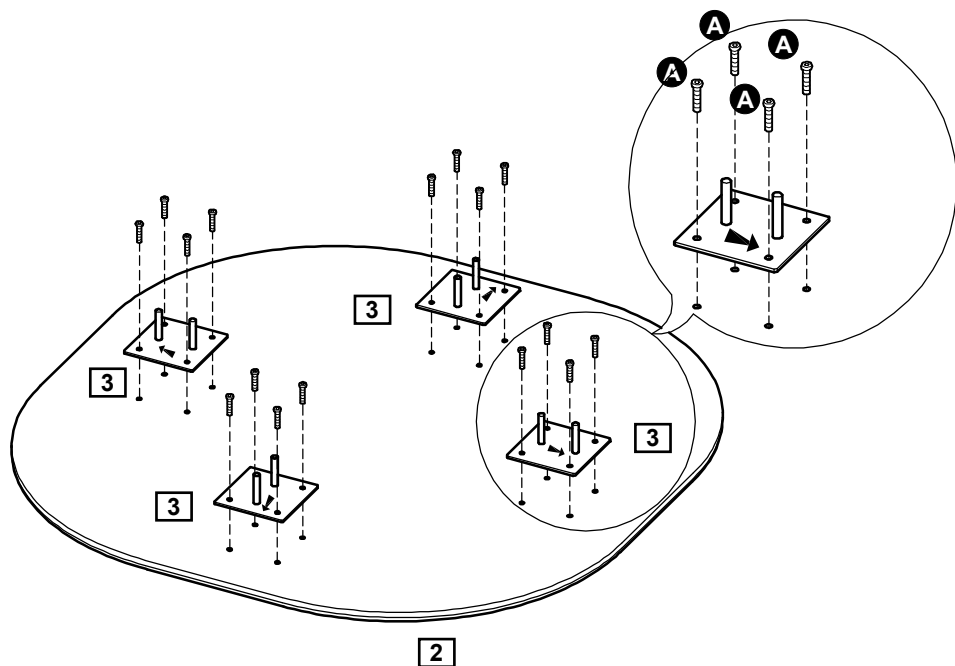

Step 2

Assemble legs

Position leg **1** over the connecting board and secure using nuts **B** by using wrench **C**.

Note: Make sure the direction of the table legs is the same as shown in the figure during assembling.

Assembly is complete.

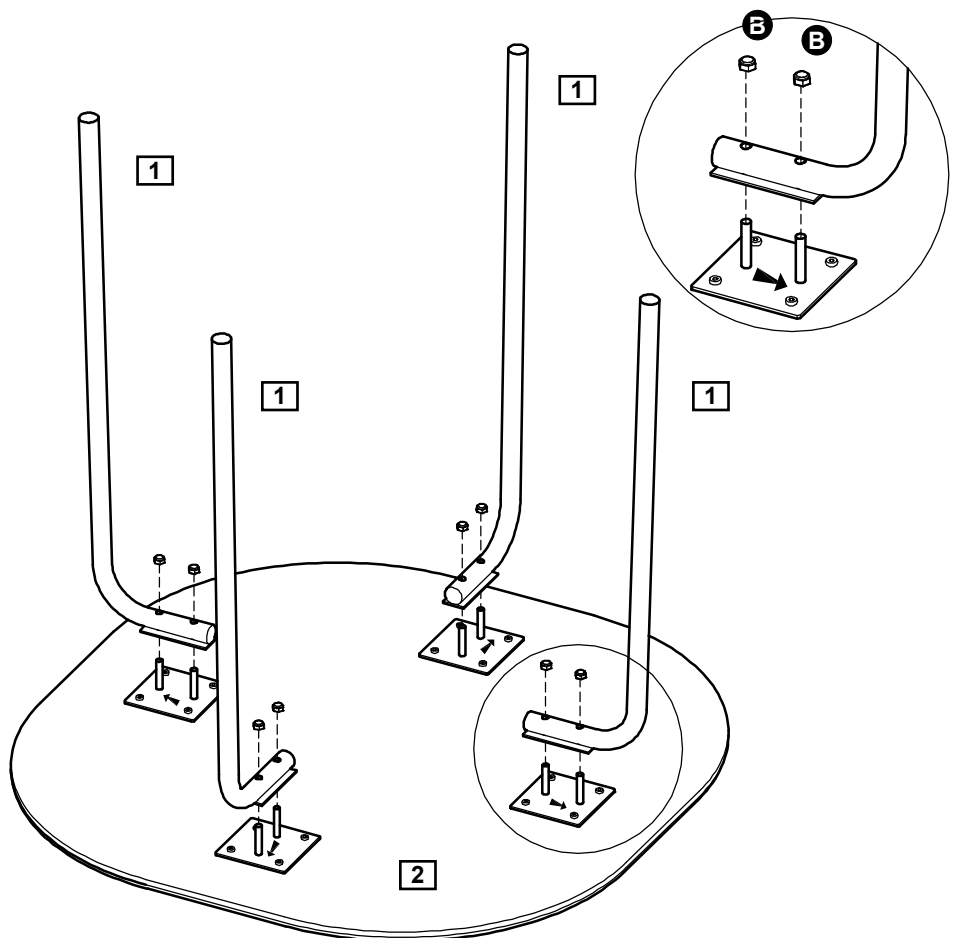

If you need help or have damaged or missing parts, call the **Customer Helpline: 0845 6400800**

Amparo Chair

Assembly Instructions - Please keep for future reference

633/3252

633/3276

hygena

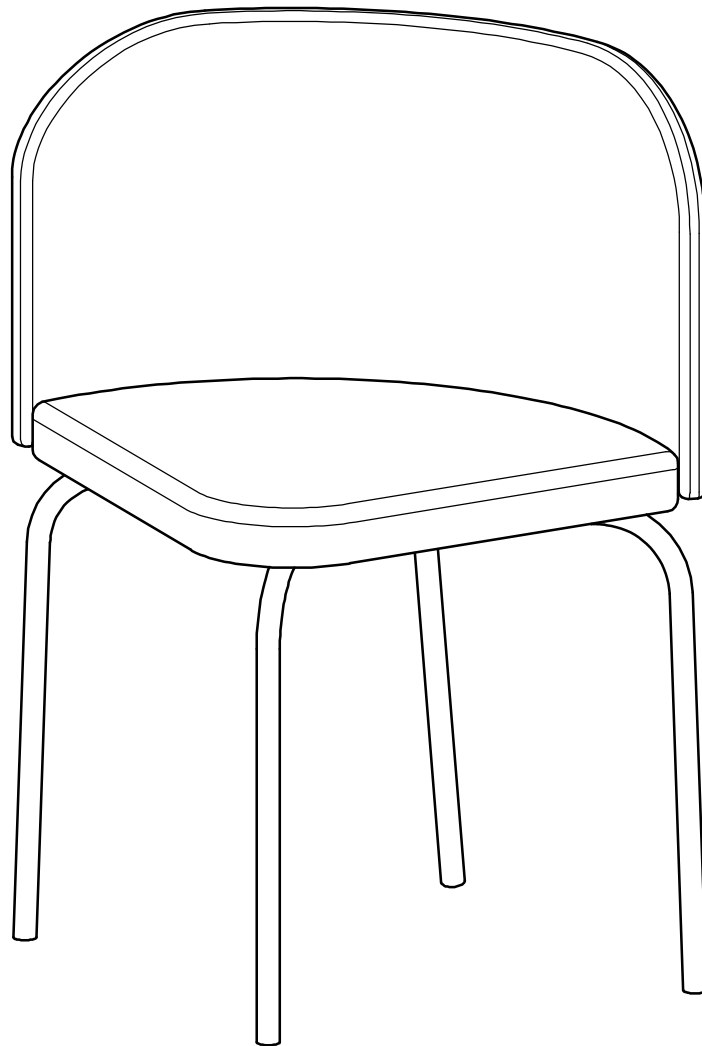

Dimensions

Width - 58cm

Depth - 49cm

Height - 75cm

Important – Please read these instructions fully before starting assembly

If you need help or have damaged or missing parts, call the **Customer Helpline: 0845 6400800**



Safety and Care Advice

Important – Please read these instructions fully before starting assembly

- Check you have all the components and tools listed on page 2.

- Remove all fittings from the plastic bags and separate them into their groups.

- Keep children and animals away from the work area, small parts could choke if swallowed.

- Make sure you have enough space to layout the parts before starting.

- Do not stand or put weight on the product, this could cause damage.

- Assemble on a soft level surface to avoid damaging the unit or your floor.



- We do not recommend the use of power drill/drivers **for inserting screws**, as this could damage the unit. Only use hand screwdrivers.

- Dispose of all packaging carefully and responsibly.

- Maximum safe weight of user: 110kgs.

Care and maintenance

- Only clean using a dry cloth, do not use bleach or abrasive cleaners.

- Make time to time check that there are no loose screws on this unit.

- This product should not be discarded with household waste. Take to your local authority waste disposal centre.

Components - Panels

If you have damaged or missing components,
call the **Customer Helpline: 0845 6400800**

Please check you have all the panels listed below

The quantities below are for 4 chairs

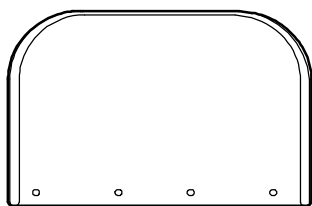

1 Chair back x 4
(54.2 x 34.7 cm)

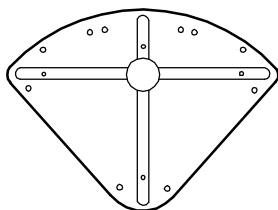

2 Chair seat x 4
(52.6 x 39.5 cm)

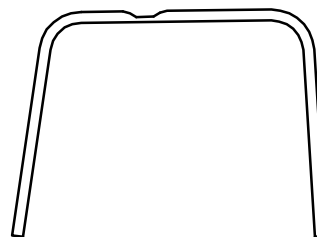

3 Chair leg x 4
(48.8 x 43.2 cm)

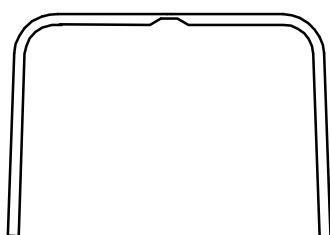







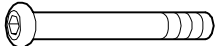
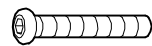

4 Chair leg x 4
(57.7 x 42.9 cm)

Components - Fittings

Please check you have all the fittings listed below

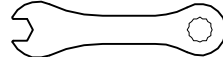
Note: The quantities below are the correct amount to complete the assembly of 4 chairs. In some cases more fittings may be supplied than are required.

A  64mm Bolt x 16	B  32mm Bolt x 16	C  28mm Bolt x 4
D  Nut x 4	E  Insert nut x 16	F  Plain washer x 20
G  Spring washer x 16	H  Bolt cap x 16	I  Wrench x 1
J  Hex key x 1		

Tools required

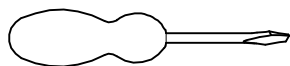

Flatblade screwdriver

Ruler - Use this ruler to help correctly identify the screws

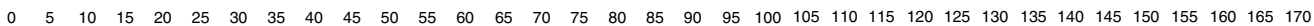

Assembly Instructions

Step 1

Assemble legs

Assemble chair leg **3** and **4** using bolt **C**, plain washer **F** and nut **D**.

Note: Do not fully tighten the bolts.

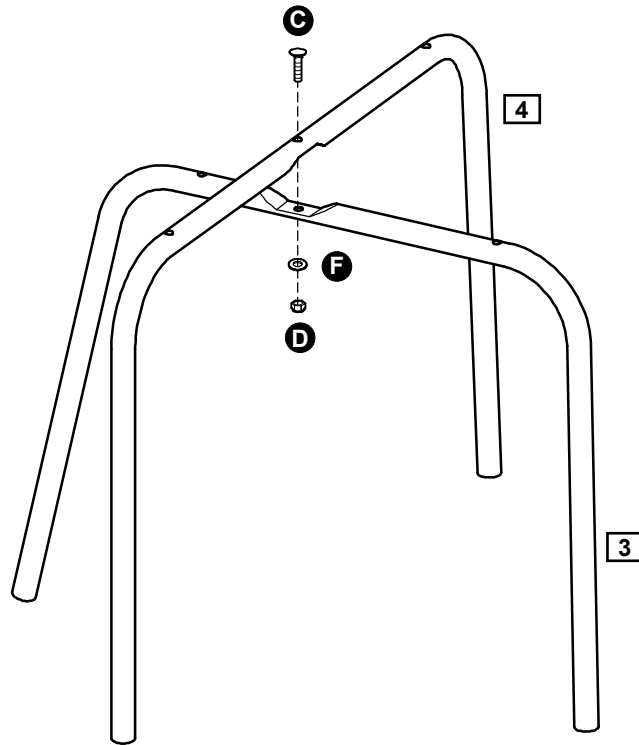

Step 2

Assemble seat and back

Two people are needed here

a: Place chair seat **2** upside down, put insert nuts **E** into the holes on the underside of the seat, make sure the threaded hole of the insert nut is aligned with the holes in the edge of the chair seat as shown in the figure.

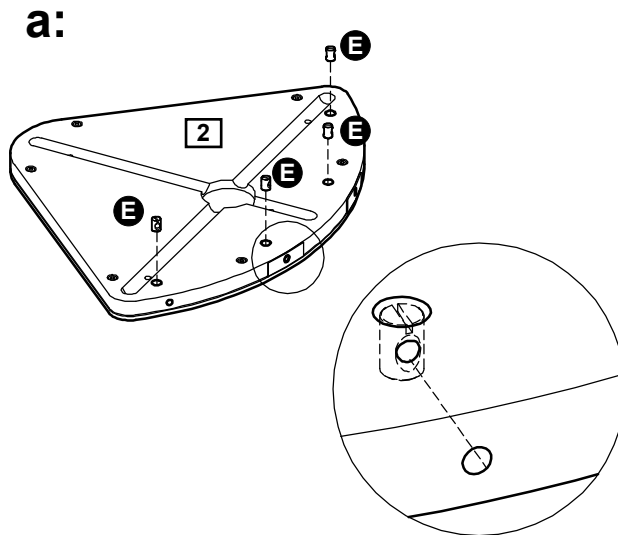

Continued on next page.

Assembly Instructions

Step 2 - continued

b: Assemble chair back **1** to the seat using bolts **A**, spring washers **G** and plain washer **F**, and secure tightly by using hex key **J**,

Note: Use a screwdriver to turn the insert nut slightly as shown in the figure if the bolt could not screw in.

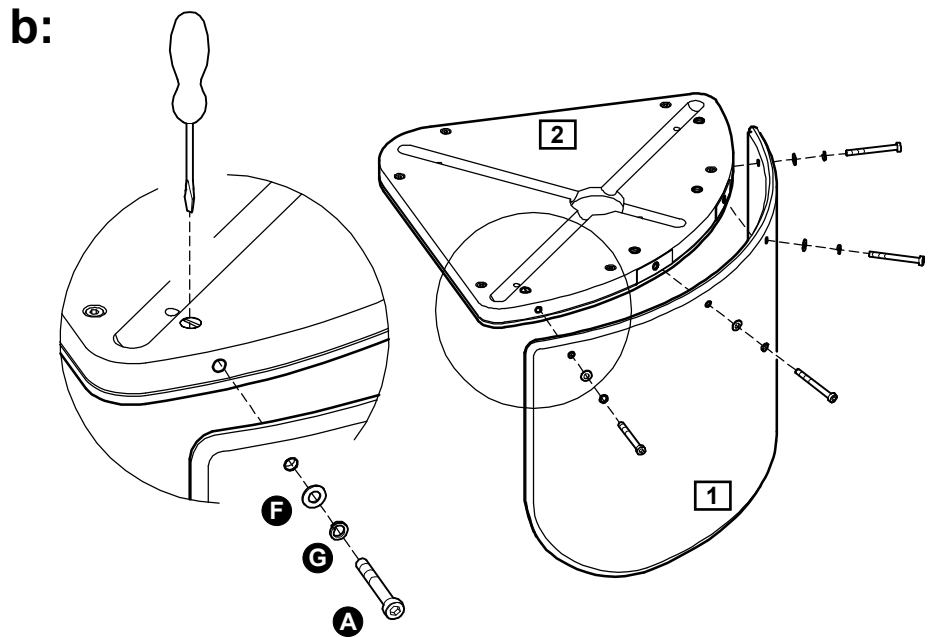

Step 3

Assemble legs

Fix the chair legs to the seat using bolts **B**.

Note: Re-tighten all the bolts and nuts.

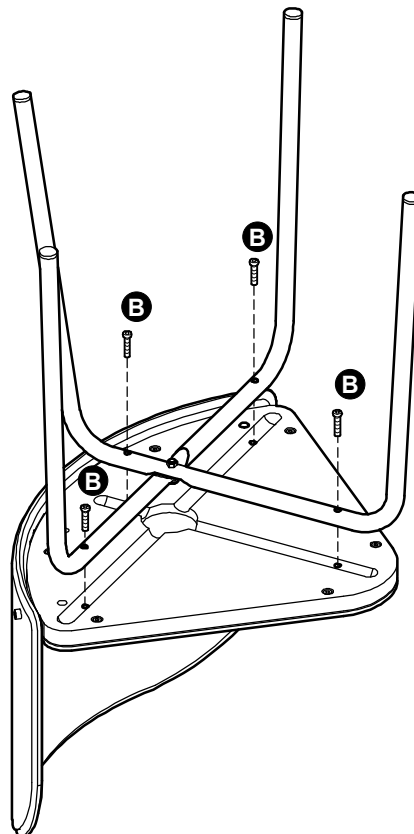

Assembly Instructions

Step 2 - continued

Assemble bolt cap

Turn the chair to back to its up- right position, then cover the bolts on the back of the chair with bolt cap **H** .

Assembly is complete.

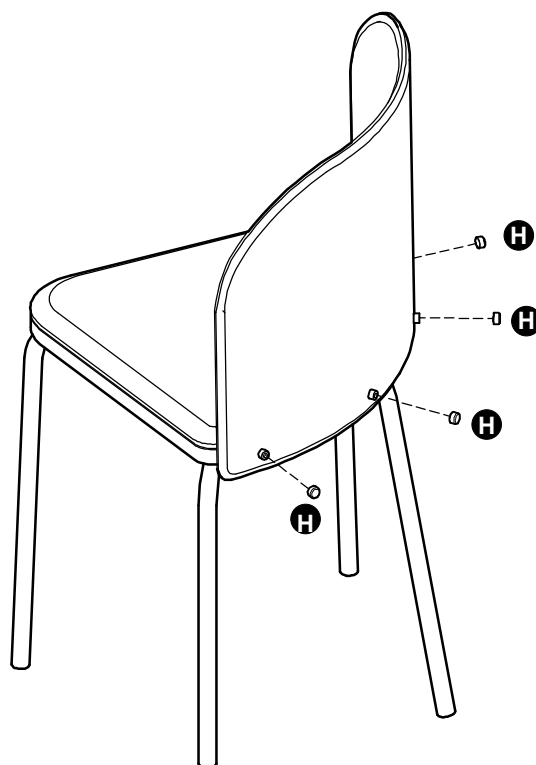

If you need help or have damaged or missing parts, call the **Customer Helpline: 0845 6400800**