

Panasonic

Basic Operating Instructions

Blu-ray Disc™ Player
Model No. DMP-BDT280
DMP-BDT180
DMP-BDT167
DMP-BD84



Unless otherwise indicated, illustrations in these operating instructions are of DMP-BDT280.

Firmware updates

Panasonic is constantly improving the unit's firmware to ensure that our customers are enjoying the latest technology. Panasonic recommends updating your firmware as soon as you are notified. For details, refer to the back side of this leaflet.

Model number suffix "EB" denotes UK model.

EB GN GA GH

SQT1274
F1215BD0

Thank you for purchasing this product.

Please read these instructions carefully before using this product, and save this manual for future use.

A more detailed operating instructions is available in "Operating Instructions (PDF format)". To read it, download it from the website.

<http://av.jpn.support.panasonic.com/support/global/cs/bd/oi/index.html>



You will need Adobe Reader to browse or print the Operating instructions (PDF format).

You can download and install a version of Adobe Reader that you can use with your OS from the following website.

<http://www.adobe.com/products/acrobat/readstep2.html>

Accessories

Check the supplied accessories before using this unit.

1 Remote control

BDT280

[For the United Kingdom and Ireland]
(N2QAYB001031)

[For Australia and New Zealand]
(N2QAYB000962)

BDT180

[For the United Kingdom and Ireland]
(N2QAYB001030)

[For the South East Asia and HongKong]
(N2QAYB001033)

BDT167 | BD84

[For the United Kingdom and Ireland]
(N2QAYB001029)

[For the South East Asia and HongKong]
(N2QAYB000958)

2 Batteries for remote control

BDT280 | BDT180

AC mains lead

[For the United Kingdom and Ireland]
(K2CT2CA00007)

[For Australia and New Zealand]
(K2CJ2DA00014)

[For the South East Asia and HongKong]*

BDT167 | BD84

1 AC adaptor

[For the United Kingdom and Ireland, HongKong]
(SAE0003)

[For Australia and New Zealand]
(SAE0004)

[For the South East Asia]
(SAE0002)

[Except the United Kingdom and Ireland]

1 HDMI Cable



- Product numbers are provided in these operating instructions correct as of December 2015. These may be subject to change.
- Do not use AC mains lead and AC adaptor with other equipment.
- Do not use any other AC mains lead and AC adaptors except the supplied one.

* See "STEP 1: Connecting to a TV" for more information.

Using the remote control

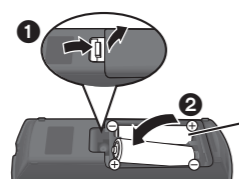

R6/LR6, AA
(Alkaline or manganese batteries)

Insert the batteries to the terminal so that it (+ and -) matches those in the remote control.

- Turn the unit on and off
- TV operation buttons
You can operate the Panasonic TV using this unit's remote control. Some buttons may not work depending on the TV.
[TV]: Turn the TV on and off
[AV]: Change input
[+ VOL]: Adjust the volume
- Select title numbers, etc./Enter numbers or [BDT280 | BDT180] characters
- Cancel
- Change soundtrack
- Basic playback control buttons
- [For the United Kingdom and Ireland]
[For Australia and New Zealand]
Show Pop-up menu
[For the South East Asia and HongKong]
Show USB Sharing menu
- Show Top menu
- Show Option menu
- Coloured buttons (red, green, yellow, blue)
Used for various purposes depending on the display.
- Transmit the remote control signal
- Open or close the disc tray
- Show the status messages
- [BDT280]
Show Miracast™ screen
[BDT180 | BDT167 | BD84]
Switch Secondary Video on/off (Picture-in-picture)
- Show the Home Screen of Network Service
- Exit the Menu screen
- [For the United Kingdom and Ireland]
[For Australia and New Zealand]
Show Netflix screen
[For the South East Asia and HongKong]
Show Pop-up menu
- Show HOME menu
- [▲, ▼, ◀, ▶]: Move the highlight for selection
[OK]: Confirm the selection
[⏮]: Frame-by-frame
- Return to previous screen

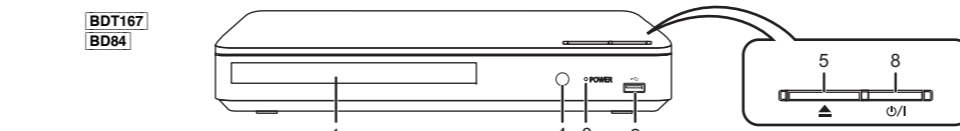
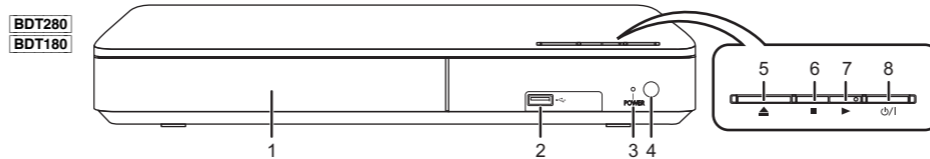

- Disc tray
- USB port
- POWER LED
The LED lights when the unit is turned on, and flashes when error occurs.
- Remote control signal sensor
Distance: Within approx. 7 m
Angle: Approx. 20° up and down, 30° left and right
- Open or close the disc tray
- [BDT280 | BDT180]
Stop
- [BDT280 | BDT180]
Start play
- Standby/on switch (⏻/⏻)
Press to switch the unit from on to standby mode or vice versa. In standby mode, the unit is still consuming a small amount of power.

Quick Start Guide

STEP 1 : Connecting to a TV

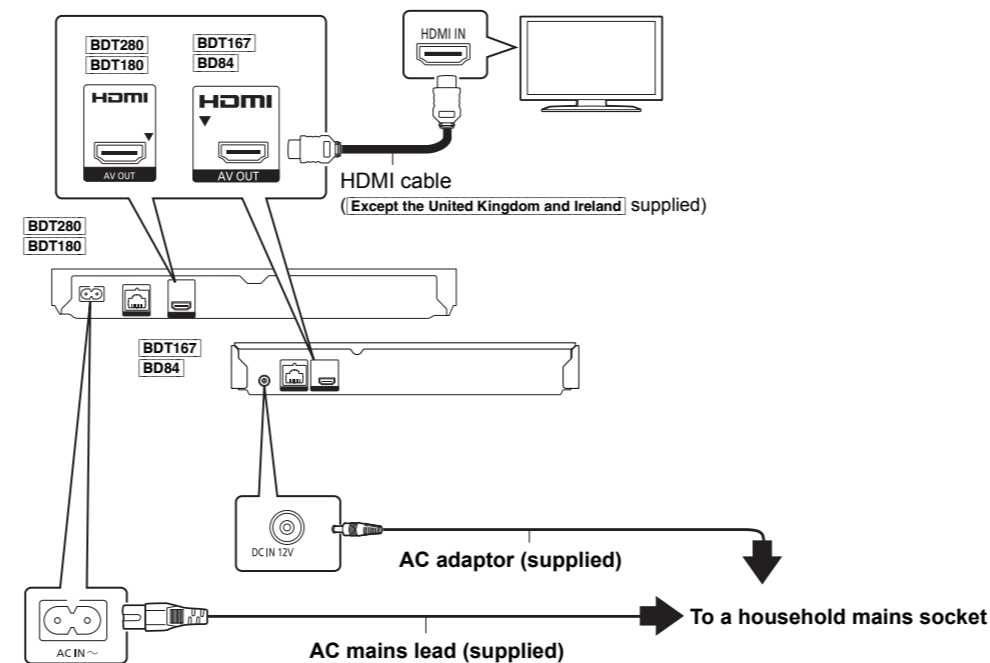

BDT180 | [For the South East Asia and HongKong]

2 AC mains leads are supplied.

Use the AC mains lead that matches the socket for the area you live in.

- Thailand: With a label

- This unit consumes a small amount of AC power (⇒ "Specifications") even when turned off in standby mode. For the purpose of energy conservation, the unit should be disconnected if you will not be using it for extended period of time.
- [BDT167 | BD84] The unit is in the standby condition when the AC adaptor is connected. The primary circuit is always "live" as long as the AC adaptor is connected to an electrical outlet.

Caution for AC Mains Lead

(For the AC mains plug of three pins)

For your safety, please read the following text carefully.

This appliance is supplied with a moulded three pin mains plug for your safety and convenience.

A 5-ampere fuse is fitted in this plug. Should the fuse need to be replaced please ensure that the replacement fuse has a rating of 5-ampere and that it is approved by ASTA or BSI to BS1362.

Check for the ASTA mark ⚡ on the body of the fuse. If the plug contains a removable fuse cover you must ensure that it is refitted when the fuse is replaced.

If you lose the fuse cover the plug must not be used until a replacement cover is obtained.

A replacement fuse cover can be purchased from your local dealer.

Before use
Remove the connector cover.

How to replace the fuse
The location of the fuse differ according to the type of AC mains plug (figures A and B). Confirm the AC mains plug fitted and follow the instructions below.

Illustrations may differ from actual AC mains plug.

1. Open the fuse cover with a screwdriver.

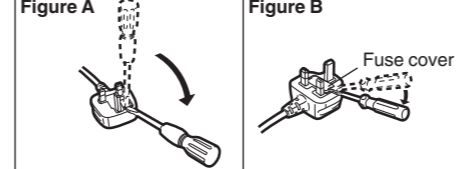

2. Replace the fuse and close or attach the fuse cover.

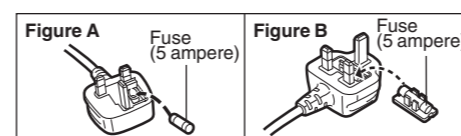

STEP 2 : Connecting to the network

BDT280

Wireless LAN connection



LAN cable connection

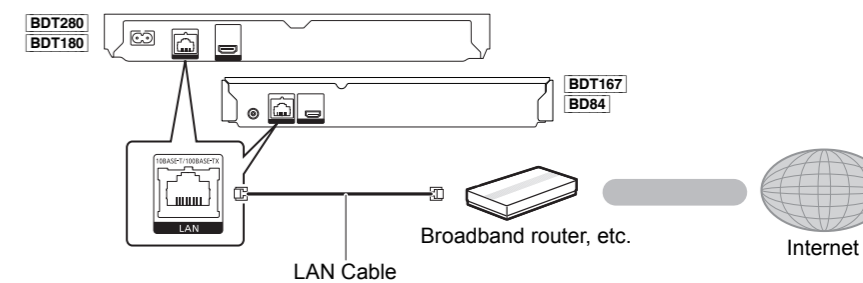

Use category 5 or above straight LAN cables (STP) when connecting to peripheral devices.

STEP 3 : Settings



Turn on the TV and select the appropriate video input.

Press [⏻/⏻].
Follow the on-screen instructions to continue with the settings.

STEP 4 : Playback

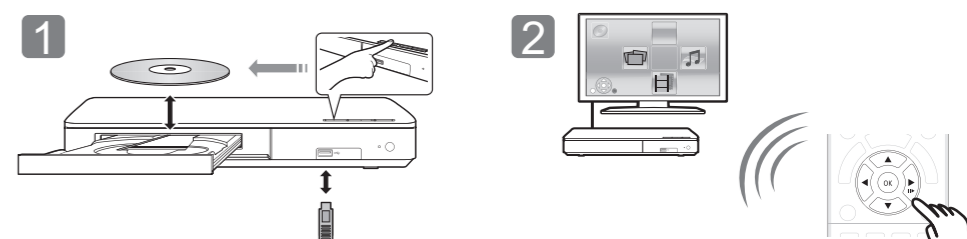

Insert the media.

Press [OK] or [▲, ▼, ◀, ▶] to select the item.
• If there are any other items, repeat this step.

Operating during playback

Following functions may not work depending on the media and contents.

Function	Operation	Notes
Stop	Press [■STOP].	The stopping point is memorized. Resume play function Press [▶PLAY] to restart from this point. • The point is cleared if the media is removed.
Pause	Press [⏸PAUSE].	Press [⏸PAUSE] again or [▶PLAY] to restart play.
Search	While playing, press [SEARCH◀◀] or [SEARCH▶▶].	The speed increases up to 5 steps. • Press [▶PLAY] to revert to normal playback speed.
Slow motion	While paused, press [SEARCH▶▶].	
Skip	While playing or paused, press [◀◀] or [▶▶].	Skip to the title, chapter or track.

Playable media

BD-Video: Video

BD-RE: Video, JPEG, MPO*, AAC, ALAC, DSD, FLAC, MP3, WAV, WMA

BD-R: Video, MKV, Xvid, AAC, ALAC, DSD, FLAC, MP3, WAV, WMA

DVD-Video: Video

DVD-R/DVD-R DL: Video, AVCHD, MKV, Xvid, JPEG, MPO*, AAC, ALAC, DSD, FLAC, MP3, WAV, WMA

DVD-RW/+R/+RW/+R DL: Video, AVCHD

Music CD: Music [CD-DA]

CD-R/CD-RW: MKV, Xvid, JPEG, MPO*, AAC, ALAC, FLAC, MP3, Music [CD-DA], WAV, WMA

USB devices (up to 4 TB): MKV, MP4, MPEG2, Xvid, JPEG, MPO*, AAC, ALAC, DSD, FLAC, MP3, WAV, WMA

Region management information

The unit can play back BD-Video/DVD-Video discs of the following regions codes, including "ALL":

Example: BD-Video DVD-Video

[For the United Kingdom and Ireland]



[For Australia and New Zealand]



[For the South East Asia and HongKong]



* [BDT280 | BDT180 | BDT167] only

Control reference guide

When other Panasonic devices respond to the remote control of the unit, change the remote control code.

[For the United Kingdom and Ireland]

[For Australia and New Zealand]

[For the South East Asia and HongKong]

