

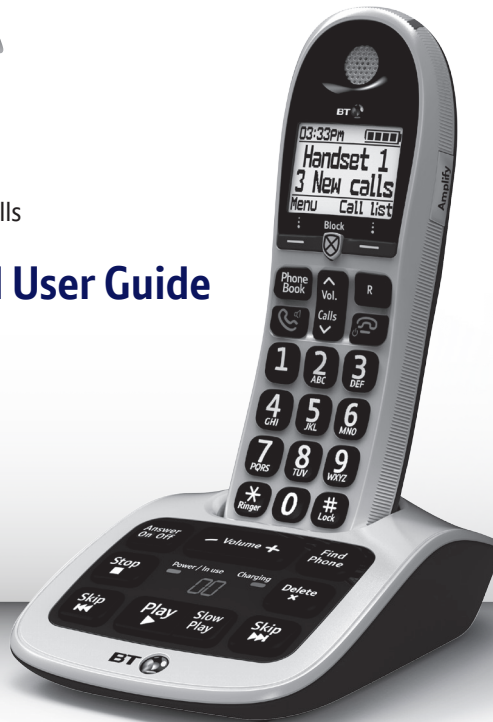

Designed to block nuisance calls

Quick Set-up and User Guide



BT4600 Premium Nuisance Call Blocker

Big Button Cordless Phone with Answer Machine

Powered by
trueCall
STOPS NUISANCE CALLS

! You need a Caller Display service from your network provider to use Call Blocking and other Caller Display enabled features. Charges may apply.

Check box contents



Handset



Base



Telephone line cord
(pre-installed)

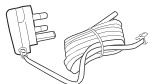

Mains power adaptor
(item code 066270)



2 x AAA Ni-MH 750 mAh
rechargeable batteries
(already in handset)

Contents for each additional handset (multipacks only)



Handset



Charger

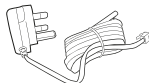

Mains power adaptor
(item code 066270)



2 x AAA Ni-MH 750 mAh
rechargeable batteries
(already in handset)



Inductive coupler

The BT4600 has an in-built inductive coupler for use with digital hearing aids.



Important: Only use the mains power adaptors, cables and rechargeable batteries supplied in this box or this product might not work. Any replacement rechargeable batteries must be of the same type. BT accepts no responsibility for damage caused to your BT4600 if you use any other type of batteries.

In this guide

Quick set up	7	Menu map	30
BT Call Blocking	18	Base	32
Record your Announce message	19	Using the phone	
The Block button.....	20	Switch the handset on or off.....	33
How do you accept, block or send a call to the answer phone?.....	21	Make an external call.....	33
How do I change the different BT Call Blocking modes?	22	Preparatory dialling.....	33
To change to Announce or Answer phone	22	End a call	33
Switch BT Call Blocking on/off	22	Receive a call	33
To add a number to the Blocked list ..	24	Call Waiting.....	34
To add a number to the Allow list.....	24	Mute	34
Deleting your Blocked and Allowed lists	25	Incoming speech/Handsfree volume..	35
To block numbers by area code	25	Amplify.....	35
Getting to know your phone		Make a handsfree call.....	35
Handset buttons	26	Answer a call handsfree.....	36
Handset display/display icons	28	Switch to handsfree during a call	36
Finding your way around your phone..	29	Redial	36
		Voicemail (1571)	36
		Record a call	37
		Play a recorded call	37

4 Check box contents

Lock/unlock the keypad	38	Dial a speed dial entry	47
Turn the handset ringer on or off	38	Edit a speed dial entry	48
Finding handset (paging).....	38	Delete a speed dial entry	48
Call control settings		Caller Display and the Calls list	
Set-up Do not disturb	39	Caller Display	49
Set outgoing calls control	40	Calls list	49
Assign VIPs	41	Missed call notification.....	50
Change the access PIN.....	42	View and access options in the Calls list.....	50
Phonebook		Block or Allow a Calls list entry.....	51
Store a contact.....	43	Save a Calls list entry to your contacts..	51
Character map	44	Delete an entry in or the entire Calls list.....	52
Assign a ringtone to a contact	44	Answer machine	
View/dial a contact	45	Using the answer machine from the handset	53
Edit a contact.....	45	Switch the answer machine on or off..	53
Delete a contact.....	46	Set the answer mode	53
Delete all contacts.....	46	Outgoing messages.....	54
View the contact memory status	46	Record your own outgoing message .	54
Speed dial			
Save a speed dial entry	47		

Play the current outgoing message... 55	Delete all old (played) messages 63
Reinstate the pre-recorded outgoing message..... 55	Remote access 64
Record a memo 56	Set the remote access PIN for the first time..... 64
Answer delay 56	Change the remote access PIN..... 65
Set the answer delay 57	Turn remote access on or off..... 65
Set the maximum message length.... 57	If you forget to switch on your answer machine..... 65
Set the message alert on or off 58	Operating your answer machine remotely 66
Call screening..... 58	Settings
Turn call screening on or off..... 58	Set the handset ringtone for external or internal calls 67
Using call screening..... 59	Set the handset ringer volume..... 67
Message playback using the handset 59	Adjust the handset ringer tone 68
Delete a message 61	Turn the handset tones on or off..... 68
Delete all old (played) messages 61	Change the handset display contrast . 68
Save a number in the answer phone message list to your contacts..... 61	Turn the screensaver on or off..... 69
Using the answer machine from the base..... 62	Change the handset name 69
Switch the answer machine on or off . 62	Change the call settings 69
Message playback using the base 62	

6 Check box contents

Set the base ringtone melody	70	Make an internal call between handsets	80
Set the base ringer volume	70	Transfer a call	80
Set a PBX access code	71	Hold 3-way call	81
Change the system PIN	71	Help	82
Reset the handset or base settings ...	72	General information	
Delete the handset or base user data .	72	Safety information	86
Clock/Alarm		Cleaning	87
Set the time and date	73	Environmental	87
Set an alarm	73	How to recycle your equipment	87
Stopping the alarm when it goes off .	74	Guarantee	88
BT Calling Features		Technical information	89
Pre-stored numbers in the Calling Features menu	75	Connecting to a switchboard	89
Using Call Diversion	75	Declaration of Conformance	89
Cancel Ringback	76		
Using Call Waiting	76		
Using Call barring	77		
Using additional handsets			
Registering an additional handset	78		
De-register a handset	79		

Quick set up guide

1 Plug in

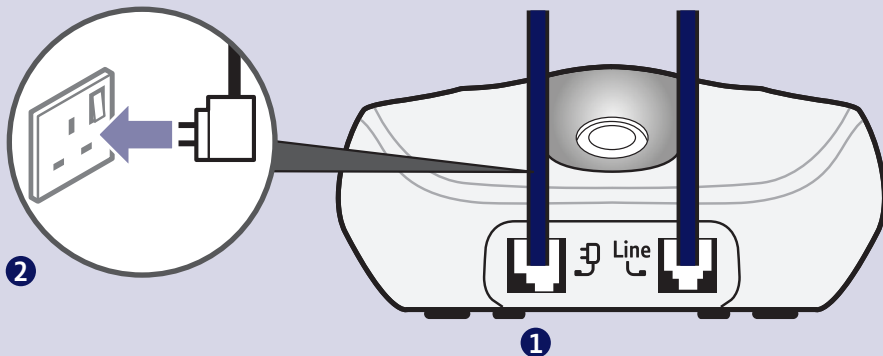

1. Plug the mains power adaptor into the base.
2. Plug the other end of the power adaptor into the wall power socket and switch on.

The phone line cord is pre-installed but **don't** plug the other end into the wall socket yet.

2 Activate the batteries

1. Activate the batteries by pulling the plastic tab away from the back of the handset.

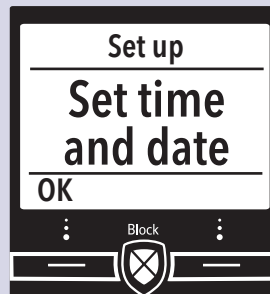
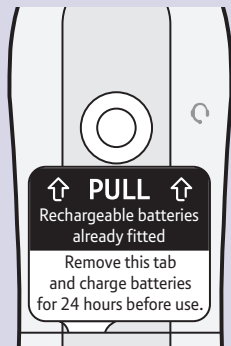

2. The BT logo will appear on the screen, followed by the set up wizard screen displaying **Please set the time and date**. Don't follow these instructions yet. Place your handset on the base to charge first.

3 Charge

Place the handset on the base and leave to charge for **24 hours**.

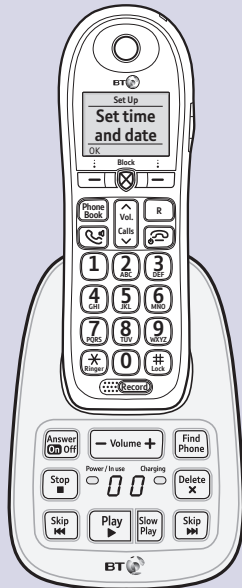

! **Important**
Charge the handset batteries for 24 hours or your phone might not work.



! If your screen displays this message, don't worry. This is normal and will continue to be displayed until you connect the phone line cord in Step 4.

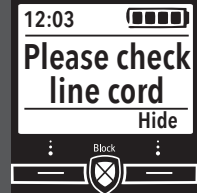

4 Connect the phone line cord

After 24 hours, plug the phone line cord into the phone wall socket.

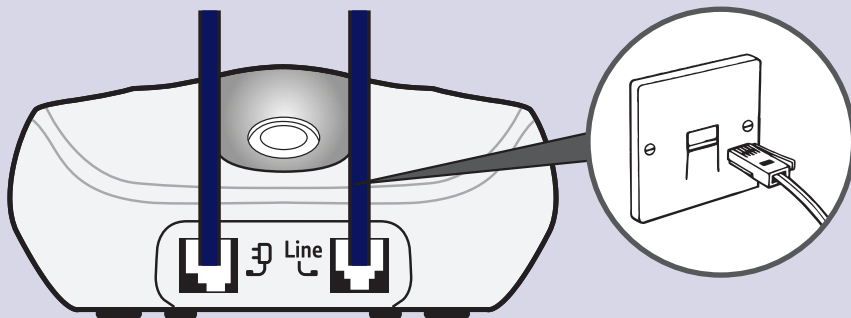

! If you ever need to remove the batteries, simply slide open the battery compartment cover and ease out the batteries.

5 Follow the set up wizard

Set the time and date

1. Select **OK** by pressing the Left option button  under the screen. The set up wizard will begin. Follow the prompts to complete the set up process.
2. Use the keypad to enter the time using the 24 hour clock format e.g. for **3:32 pm** you need to enter **15:32**.
3. Press **Next** enter the date in the format **DD/MM/YYYY**.
4. Press **Save**. **Saved** is displayed.

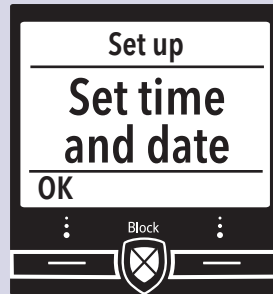

Complete the set up tasks

5. If you wish to continue following the set up wizard, select **Yes**. (If you don't want to follow the wizard, select **No** and you can start using your phone straight away. You can always set up tasks via the menu later).

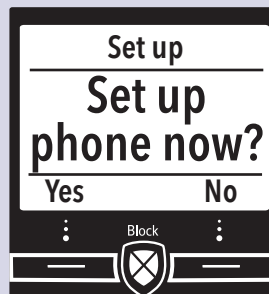

Record your answer phone outgoing message

6. If you wish to complete this step, select **Yes** (or **No** to continue to the next step).
7. Follow the voice prompt and record your message into the phone after the tone.
8. Select **Save** when you've finished.
9. Your message will be played back to you.
10. Select **OK** (or **Delete** if you want to replace it).



BT Call Blocking

11. Continue to read and follow the prompts.
12. Press **OK**.
13. Press **OK**.

 You need to have a Caller Display service from your network provider to use all the features available e.g. Call Blocking, Visual Voicemail, Calls List, Text Messaging and other Caller Display enabled features. Charges may apply.



14. Select **Yes** or **No**, and follow the prompts.

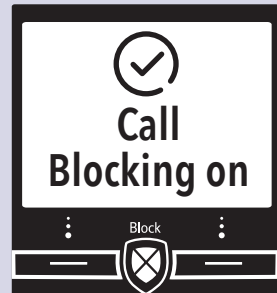
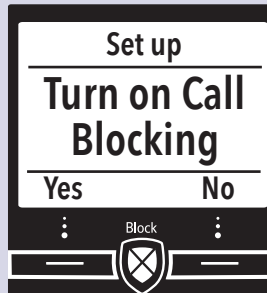

Add contacts

15. If you want to add some contact numbers now, select **Yes** (or select **No** to continue to next step).



☰ By adding contacts, you will always know that their calls will get straight through to you, without the need to go through the BT Call Blocking announcement.

☰ Please make sure you always add the full telephone number when you save a contact. If you have important numbers that will always need to get through e.g Doctors surgery, National Floodline, Carer Line numbers etc, make sure you've added them to your Contacts or Allowed list.

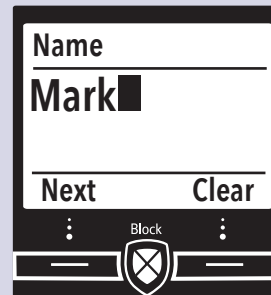
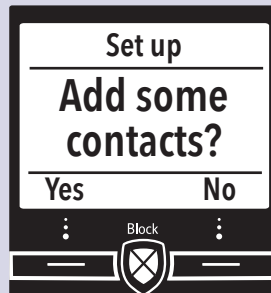
16. Enter the contact name using the keypad and press **Next** (see page 43/44 for more info).
17. Enter the number and press **Save**.



☰ You now have the option to make your contact a VIP, this means that when you use features like “Do not Disturb or Outgoing Call Control” you will always be able to make and receive calls to these numbers. (e.g If you barred Outgoing Calls to Mobiles, those that are set as a VIP will still be allowed to be dialled.)

18. VIP status : Press  or  to choose between **Off** or **On. All calls** allowed and select **Save**.
19. Select **Yes** if you want to enter more contacts or **No** if you don't want to.

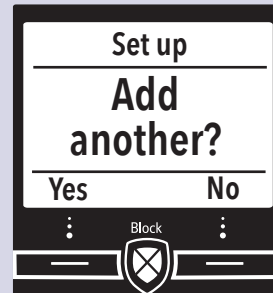
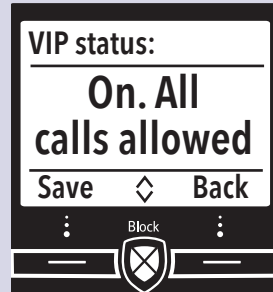

20. You can now start using your phone.

Please read the rest of this User Guide for instructions on how to use the most popular features of your BT4600 phone.

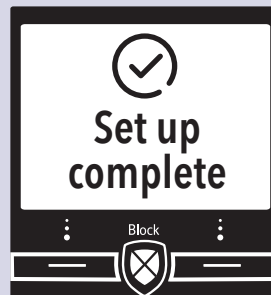

6 Set up your additional handsets (multi packs only)

1. For additional handsets and chargers: plug the mains power adaptor into the back of the charger and plug the other end into the mains wall socket and switch on the power.

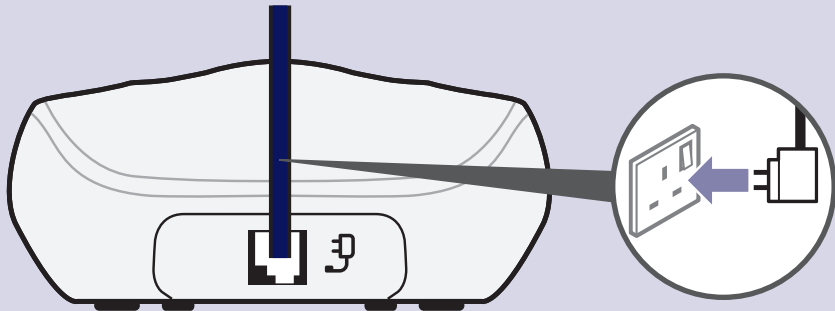

2. Activate the batteries as explained on page 8. Once you've set the time and date on the first handset then it will be shared with all other handsets in your multi-pack after you activate the batteries.
3. Place the handset on the charger to charge for 24 hours.

BT Call Blocking

The best way to stop unwanted calls, is to know who's at the other end of the phone before you decide if you want to take it.



You need Caller Display

This will help you get the most out of your BT Call Blocking. You can get it from your phone service provider (Charges may apply).

Your BT4600 has two BT Call Blocking modes to help you easily manage your incoming calls in different ways. When set to:

- Announce (all calls not saved in your **Contacts**, **Allow** and **Speed dial** list must say their name. They will hear, “Callers to this number are being screened by a BT Call Blocking phone please say your name after the tone and then press # and wait to be connected”. Those on your Blocked list will hear, “Callers to this number are being screened by a BT Call Blocking phone, the person you are calling isn’t accepting your call. Please hang up”).
- Answer phone (all calls not in your **Contacts** or **Allowed** list are sent straight to the Answer phone, including those on your **Blocked** list).



In Announce mode (default setting), the BT4600 will filter all first time calls from numbers that are not yet saved in your Contacts, Speed dial list or already on your allowed list. By doing this, you gradually build up your lists of allowed and blocked numbers and your BT4600 will know how to deal with the call the next time it comes in.

Record your Announce message

You can personalise the BT Call Blocking greeting, by adding your name to the Announce message.

1. Select **Menu**, scroll to **Call control** press **OK** then **BT Call blocking** menu is shown, press **OK**.
2. Scroll to **Announce messages**, press **OK**.
3. The **Record name** option will show. Press **OK** and follow the voice prompt and press **Save**.
4. Your recording will then be played back to you. If you aren't happy with it, you can press **Delete** while it's playing.

The Block button

You can use your block call button in three ways.

1. In idle mode

Press as a shortcut to the BT Call Blocking menu.

2. Incoming call

When you have an incoming call, before answering, look at the display to see who's calling.

If you know you want to block the call, press .



The number will be blocked and added to the blocked calls list if Caller ID is displayed. For calls with no caller number, withheld or unavailable you can also use the Block button to reject the call. The caller will hear, "Callers to this number are being screened by BT Call Blocking, the person you are calling is not accepting your call. Please hang up."

3. During a call

If you have already answered the call and then decide you want to block the number, press . If the number is displayed in the Caller ID, the display will give you the option to select **Yes** and the number will be added to the blocked numbers list and end the call, or select **No** to go back to the caller.

How do you accept, block or send a call to the answer phone?

1. BT Call Blocking answers a call for you and asks the caller to say (“announce”) who they are.
2. Your BT4600 then rings with the Announced call on the display and tells you the caller’s name when you pick up. (e.g. “You have a call from Mark”).
3. You now choose to:
 - accept the call, press **1**
 - always accept their calls, press **2** ALL
 - block their calls, press **3** NO, or 
 - send this call to the answer phone, press **4** CALL
 - ignore the call, just hang up (this call won’t be added to your blocked list)

 When a call starts ringing, you can block it straight away by pressing the  button. That number (if its not withheld or unavailable) will then be added to your blocked list.

How do I change the different BT Call Blocking modes?

Your BT4600 has two Call Blocking settings, Announce and Answer phone.

To change to Announce or Answer phone:

1. In idle mode, press .
2. **BT Call Blocking** menu is shown. Press **OK**.
3. Scroll to **Blocking mode**, press **OK** and then select the mode you want to use and press **OK**.

Switch BT Call Blocking on/off

When **BT Call Blocking** is set to On, it is On for whichever mode you're using (e.g. Announce mode). If you turn Call Blocking Off, all calls will be allowed through, even if they are already on your blocked list.

1. In idle mode, press .
2. **BT Call Blocking** menu is shown. Press **OK**.
3. **On/off** is displayed. Press **OK**, then press  or  to select either **On** or **Off** and press **OK**.

 When you receive a call with **BT Call Blocking** switched on you will hear the message, 'You have a call from xxxx. To accept the call press 1. To always accept their call, press 2. To block their call, press 3. To send the call to answer phone, press 4. To hear these options again, press *'.

What happens when you allow a number (caller)

When you get an allowed call, you'll see the caller's number (if available). If you don't answer a call from an allowed number, it will go through to your answer phone (if it's on) or eventually it will hang up if unanswered.

What happens when you block a number (caller)

A caller calling from a blocked number will hear a message telling them that their call has been blocked.

 The caller will hear, "Callers to this number are being screened by BT Call Blocking, the person you are calling is not accepting your call. Please hang up".

Calls that are always allowed

Ringback, Operator, VIPs and calls made from a Speed dial contact are always allowed and cannot be blocked using BT Call Blocking.

How to add numbers straight to your Blocked and Allow lists

Aside from adding numbers to your Block and Allow list as calls come through, you can also add numbers directly to the lists via your BT Call Blocking menu.

To add a number to the Blocked list

1. In idle mode, press .
2. **BT Call Blocking** menu is shown. Press **OK**.
3. Scroll to **Block numbers** and press **OK**.
4. Choose **Add number**. Press **OK**.
5. Enter the telephone number you want to block (make sure you enter the full dialling code) and press **Save**.

To add a number to the Allow list

1. In idle mode, press .
2. **BT Call Blocking** menu is shown. Press **OK**.
2. Go to **Allow numbers** and press **OK**.
3. Choose **Add number**. Press **Select**.
4. Enter the telephone number you want to allow (make sure you enter the full dialling code) and press **Save**.

Deleting your Blocked and Allowed lists

When in the Block and Allow number menus, you also have the choice to delete the whole list. Remember, if you do this, all calls previously blocked and allowed, will now be able to contact you.

To block numbers by area code

You can also block numbers by area code. This means that any calls beginning with that code, will be blocked.

1. In idle mode, press .
2. **BT Call Blocking** menu is shown. Press **OK**.
3. Scroll to **Block numbers** and press **OK**.
4. Scroll to **Area Codes** and press **OK**.
5. On first use, you will see **Add code?** Select **Yes**.
6. Add the area code (eg 01473) and press **Save**.

Getting to know your phone

Handset buttons

Left option button

In idle mode, press to enter the main menu.
Also use to access sub menus and confirm options shown on the display above the button.

3.5mm Headset socket (on side of handset)

Up/Volume

From home screen, press to change the ringer volume, see page 67.
In talk mode, press to increase the incoming speech volume.
In menu mode, press to scroll up through the options.

Phonebook

In idle mode, press to access your stored Contacts.

Talk/Handsfree

In idle mode, press to make and receive calls, page 33.
Switch handsfree on/off, page 36.

Calls/Down

From home screen, press to open and scroll through the Calls list, see page 49.
In talk mode, press to decrease the incoming speech volume.
In menu mode, press to scroll down through the options.

1 (Speed dial)

From home screen, press and hold to dial BT 1571 or your stored speed dial number, see page 47.
When answer machine message is playing, press to repeat the message from the beginning.

4

When answer machine message playing, press to skip back to the previous message.



Ringer

Press and hold to turn the handset ringer on or off.

When answer machine message playing, press to replay the message slowly.

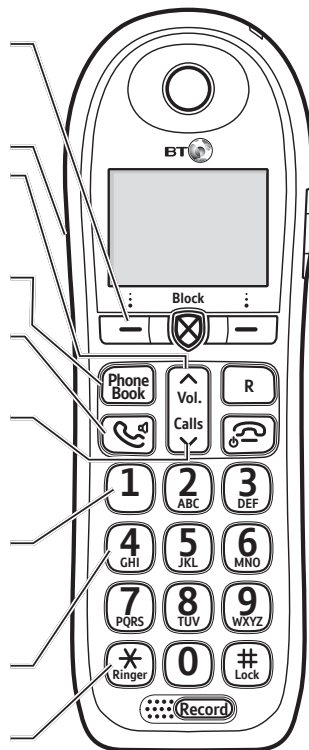

**Red LED Indicator****Call Blocking menu**

One touch call blocking and access to the Call Blocking features, see page 18.

Right option button

Press to confirm the option displayed on the screen above the button, to delete or go back to the previous screen.

In answer machine mode, deletes the current message playing.

Amplify (on side of handset)

During a call, press to boost the incoming speech volume.

R (Recall)

R (Recall) for use with some BT Calling Features and when connected to a switchboard/PBX.

End call/on or off

Press to end a call.

In idle mode, press and hold to switch the handset on or off, see page 33.

In menu mode, press to return to home screen.

3

When answer machine message is playing, press to delete the message.

6

When answer machine message playing, press to skip forward to the next message.

2-9 (Speed dial)

From home screen, press and hold buttons 2-9 to dial a stored speed dial number, see page 47.

**#
Lock**

Press and hold to lock or unlock the keypad.

Record

During a call, press to record the conversation. In idle mode, press to play recorded calls.

Handset display

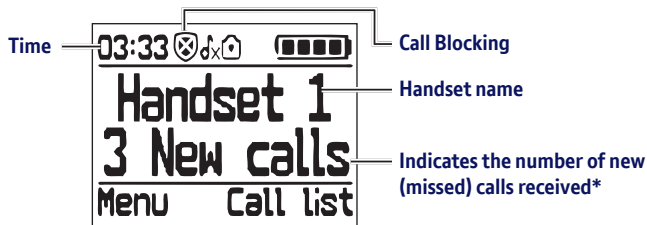

Handset display icons



Shows handset battery status.
Scrolls when the handset is charging.



Empty frame flashes when battery needs recharging.

UnMute/Mute

Indicates when Mute is on or off.



The keypad is locked.



Handset ringer is switched off.







Call Blocking is on.

* For full details of who has called you please make sure you have subscribed to Caller Display from your network provider.

Finding your way around your phone

Your BT4600 has an easy to use menu system. Each menu has a list of options, which you can see on the menu map on page 30 and 31.

When the handset is switched on and at the home screen:

1. Select **Menu** by pressing the Left option button to open the main menu.
2. Use the  or  button to scroll through the available menu options.
3. When the menu you want is displayed, select **OK** by pressing the Left option button.
4. Use the  or  button to scroll through the available sub menu options. When the sub menu you want is displayed, select **OK** by pressing the Left option button.

Select the **Back** option if you want to return to the previous screen.

To exit a menu and return to the home screen, press .

If no buttons are pressed for 60 seconds, the handset returns to the home screen automatically.

Left option button
Press to select the option displayed on the screen above the button.

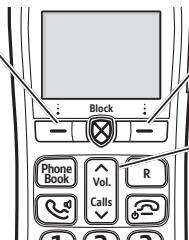

Right option button
Press to select the option displayed on the screen above the button.

Up and Down navigation buttons
Scroll up or down through the menu options.

30 Getting to know your phone

Menu map

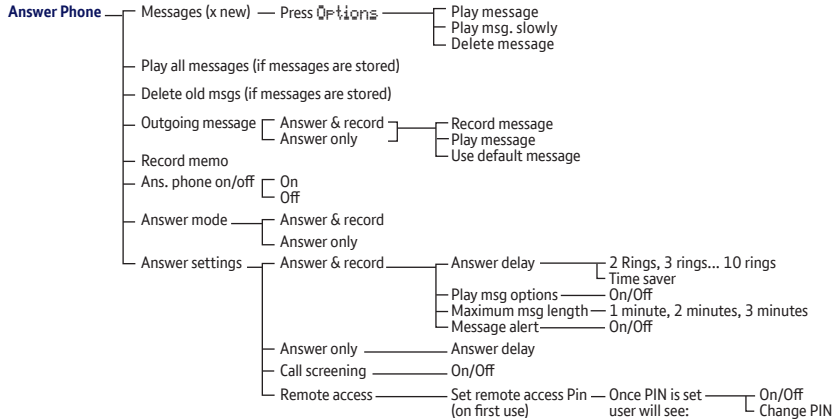

Recorded Calls

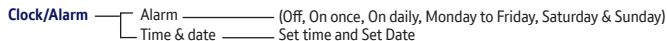
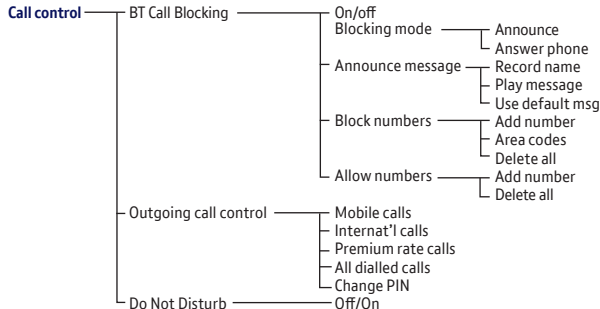

Speed Dial List — 1. 1571 2-9 Empty — (Options or Add)

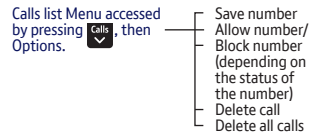
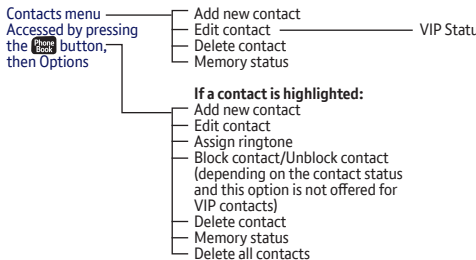
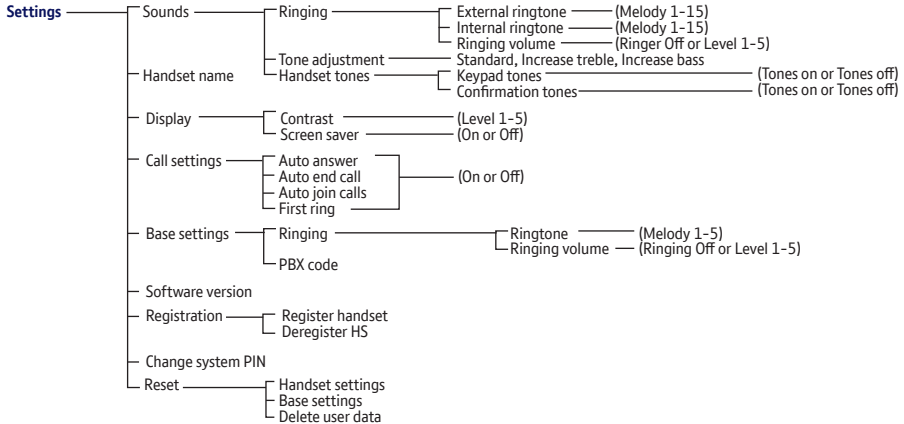
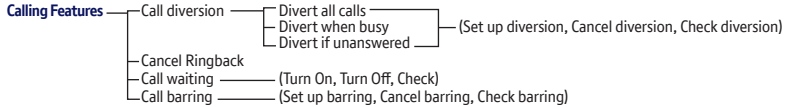

Base

Answer on/off

Press to turn the answer machine on or off. When set to On, the text 'On' will light up on the button.

Vol-

Decrease the speaker volume during playback, the call screening volume during idle.

Vol+

Increase the speaker volume during playback, the call screening volume during idle.

Find Phone

Press to ring all registered handsets, helpful for finding a missing handset, see page 38.

Also used during the registration process, see page 78.

Power In use light

On when there is power to the base. Flashes when the line is in use or registration is taking place.

Stop

Press to stop message playback.

Skip<<

During playback, press once to skip back to the start of the current message. Press twice to skip back to the start of the previous message.

Play

Press once to play new messages. Press during playback to pause playback.

Slow Play

Press to play messages back slowly. If messages are already playing you can press this button to play them in slow play mode (to switch back to normal speed, press the  button).

Delete

Press once to delete the message during playback. In idle mode, press to delete all old messages.

Skip>>

During playback, press to skip forward to the start of the next message.

Red charging light

Battery charging light. On when the handset is in the base charging.

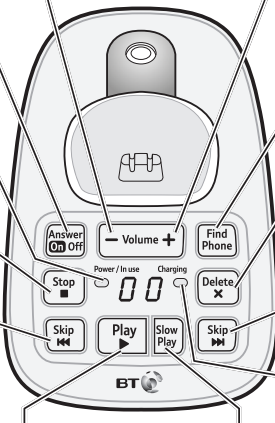

Using the phone

To switch the handset off

1. Press and hold  until the handset turns off.

To switch the handset on

1. Press  until the handset turns on.

Make an external call

1. Press .
2. When you hear the dial tone, enter the number.

Preparatory dialling

1. Enter the number first. If you make a mistake select **Clear** by pressing the Right option button to delete the last digit.
2. Press  to dial.

End a call

1. Press .

Receive a call

When you receive a call, the phone rings and the display shows **Incoming call**. If you've got a caller display service, the display shows the caller's number if it's available or the caller's name if it matches an entry stored in your phonebook's contact list.

1. Press  to accept the call. Or, to accept the call in handsfree mode, press  twice.

Call timer

Your handset will automatically time your outgoing and incoming calls. The handset shows the length of time both during and for a few seconds after your call.

When you make a call, the green In use light on the base flashes.

Auto end

If auto end is set to On you can end a call by placing the handset back in the base. If auto end is set to Off, you'll need to press  to end the call. Auto end On is the default setting. See page 70.

Auto answer

If auto answer is set to On you can answer a call by lifting the handset off the base. If auto answer is set to Off, you'll need to lift the handset off the base and press  too. Auto answer Off is the default setting. See page 70.

34 Using the phone

You can also press **R** to switch between calls.

Out of range warning

When the handset is out of range of the base, the display will show **Searching for base...**, the backlight will turn up to 100% to indicate the alert message and you will hear a warning tone. After 60 seconds the display will show **No base link. Check base.** You need to move back within range of the base station.

If you move out of range when you're on a call, you'll lose your connection. The handset will automatically re-connect to the base when you move back within range.

Call Waiting

If you've got a call waiting service and it is switched on, your phone will alert you to a second incoming call if you're already engaged on an external call.

To switch your call waiting service on or off, see page 76.

1. You'll hear the call waiting tone and if you also have caller display the display will show the number of the caller, or the name if it matches an entry in your contacts.
2. Select **Switch** by pressing the Left option button to answer the new call and your first caller is put on hold.
3. Select **Switch** to toggle between the two callers.
4. Press  to hang up the current call.



Mute

During a call, you can talk to someone nearby without your caller hearing.

1. During a call, select **Mute** by pressing the Right option button. The display shows **Call muted** and your caller can't hear you.
2. Select **Unmute** to return to your caller.

Incoming speech / Handsfree volume





During a call, you can adjust the handset incoming speech or loudspeaker volume. There are five levels. The default setting is Level 3.

1. Press  or  to increase or decrease the volume. The first press will present the Call volume screen so you can see the current volume level. Subsequent presses will change the volume, you will hear the volume level with each press.

Amplify

During a call you can boost the incoming speech volume by pressing the **Amplify** button on the side of the handset. To turn off, press the button again. The volume will only be boosted during the call, once the call has ended the incoming speech volume will return to the previously set level.

Make a handsfree call

1. Enter the number then press  twice.  is displayed. You hear your call over the handset loudspeaker. Press  to switch the call between the earpiece and the loudspeaker.
2. Press  to end the call.

Handsfree

Handsfree lets you talk to your caller without holding the handset and means that other people in the room can listen to your conversation over the loudspeaker.

During a handsfree call, press  or  to change the volume.

Answer a call handsfree

When the phone rings:

1. Press  twice to answer the call. You will hear your caller over the loudspeaker.

Switch to handsfree during a call

1. During a call, press  to put the call on the loudspeaker. To switch handsfree off and return the call to the earpiece, press  again.

Redial

Telephone numbers that you have called are saved in the Calls list. There is not a separate redial list, all calls are saved in the Calls list. The Calls list holds up to 50 incoming (missed and answered) calls and 30 outgoing calls.

To redial a number see, 'View and access options in the Calls list' on page 50. You can also save a number you've called to your contacts, delete a number you've called or delete all numbers from the Calls list, see page 52.

Voicemail (BT 1571)

1. If you have subscribed to BT Answer 1571 you can press and hold **1** to listen to your messages.

Record a call

1. During a call, press **Record**. The **®** icon will appear on the display next to the call timer to indicate that the call is now being recorded but there will be no audible notification given.
2. To stop recording, select **Stop** or press **Record**. **Recorded call saved** will be displayed.

Play a recorded call

You can either, press **Record** when the handset is in idle mode or:

1. From the home screen, press **Menu**.
2. Press **Calls** until **Recorded Calls** is displayed and press **OK**.
3. Press **Vol.** or **Calls** to scroll to the call you want to play and press **Options**.
4. Press **Vol.** or **Calls** to display either **Play call** or **Play call slowly** and press **OK**. The call will be played. Press **Stop** to stop playback or **Delete** to delete it.

When recording a call, you will be notified if there is only 1 minute of recording time left in the memory by an error tone and the display will show **Memory full in 1 minute**.

In the Recorded calls menu you can also delete a recorded call or delete all recorded calls.

38 Using the phone

You can lock the keypad so that it can't be used accidentally while you're carrying it around.



With the keypad locked, you can still call the emergency services on 999 and 112 using preparatory dialling and you can still answer incoming calls and operate the in call features as normal. When the call is ended, the  comes on again.

If you get an incoming call while you're paging a handset, the incoming call takes priority and paging will stop.

If the handset ringer is switched off on a handset, it will be temporarily switched back on so the handset can be found.

Paging calls can't be answered by a handset.



To lock the keypad

1. Press and hold  for 2 seconds. The handset gives a confirmation tone and **Keypad locked** is briefly displayed before returning to the idle screen with the  icon displayed.

To unlock the keypad



1. Press and hold  for 2 seconds. The handset gives a confirmation tone and **Keypad Unlocked** is briefly displayed before returning to idle.

Turn the handset ringer on or off

1. Press and hold  for 2 seconds to turn the handset ringer on or off. The display will briefly show **Ringer on or off** before reverting to the idle screen with the  icon displayed if the ringer has been turned off.

Find handset (Paging)

You can ring a handset to help find it.



1. Press  on the base. All handsets registered to the base will ring and the screen will show **Here I am!** for up to 2 minutes.
2. To stop the ringing, press  on the base again or select **End** or press  on any handset.

Call control settings

 To enter the Call control menu you need to enter your remote access PIN. This will need to be set the first time you try and enter the menu, simply follow the on screen instructions. If you have already changed the remote access PIN when setting your remote access then you will not need to set it again as this PIN is used for both Call control and Remote access.

Set-up Do not disturb

Do not disturb allows calls to be received silently with minimal notification. The default is off.

1. In idle mode, press .
2. Scroll to **Do Not Disturb** and press **OK**.
3. Press the  or  to select either **On** or **Off** and press **OK**.

 When set to On, the idle screen will display **DO NOT DISTURB** instead of the handset name. If you have set some Contacts to be VIPs, they will always be allowed through when Do not Disturb is on.

Set Outgoing calls control

Outgoing call control lets you 'Allow' or 'Bar' certain types of calls from being made from your BT4600, e.g Premium Rate and Mobiles. (The default setting is that ALL outgoing calls are allowed)

1. In idle mode, press .
2. **BT Call Blocking** menu is shown.
3. Scroll to **Outgoing call control** and press **OK**.
4. Outgoing calls control settings are PIN protected, so follow the instructions to set your PIN or enter your PIN and select **OK**.
5. **Mobile call** is highlighted. You can scroll through the list to **Internat'I** (for International), **Premium rate** or **All dialled calls** and press **OK** on the setting you want to change.
6. Scroll between **Allowed** and **Barred** and then press **OK**.



If 'All dialled calls' is set to Barred, this will take priority over the other settings except VIP contacts, emergency numbers 999 and 112 which can still be dialled. If set to Allowed, the status of the other settings will manage which calls can be made.





Remember, any contacts that you have made VIP will still be able to be called, when outgoing call control is on.

Assign VIPs

You can set some of your contacts to be VIPs, so that they can always get through when Do Not Disturb is switched on, or so they can always be called when Outgoing call control is set to on, see page 40.

42 Call control settings

Change the access PIN



1. In idle mode, press .
2. Scroll to **Outgoing call control** and press **OK**.
3. Enter the existing 4 digit remote access PIN and press **OK**. Press  to highlight **Change PIN** and press **OK**.
4. Enter the existing 4 digit access PIN and select **OK**.
5. Enter the new 4 digit access PIN and select **OK**, then enter it again when prompted and select **OK**. **Access PIN saved** will be displayed.

Phonebook

You can store up to 200 entries in your list of phonebook contacts. Contact entries will automatically be copied to any other handsets you have registered to the base. Any change made on one handset will be updated on all other handsets.

The handset will come with a special number pre-stored. This will include Your BT Product Helpline, All handsets (if you have more than two handsets registered) and a list of the handsets registered to the base.



Store a contact

1. From the home screen, press .
2. Select **Options. Add new contact** is displayed, press **OK**.
3. Enter the new contact name using the keypad (see note opposite for help) then press **Next** and enter the number and press **Save**.
4. Press  or  to choose between **VIP Off** or **On. All calls allowed** and select **OK**.

You must enter a name and a number for the contact to be stored.

Names can be up to 14 characters and numbers up to 24 digits.

Entering names

Use the keypad letters to enter names, e.g. to store Tom: Press  once to enter T. Press  three times to enter o. Press  once to enter m.

Writing tips

To delete the last digit/character entered, select **Clear**.

Press  to switch between text entry modes: sentence case (Abc), upper case ABC), lower case (abc) or numeric (123).

Press  to insert a space.

To enter a pause in a contact number

When storing a number, press and hold  in the place where you want the pause. **P** will be displayed.

To enter a recall in a contact number

When storing a number, press  in the place where you want the recall.







There are 15 melodies to choose from (Melody 1-15) or Normal which is the standard ringtone that is first assigned when you save a contact in your phonebook.

Character map





1	& . , ' ? ! @ 1
2	a b c 2 à á â ã ä æ ç
3	d e f 3 è é ê ë
4	g h i 4 î ï í
5	j k l 5 £
6	m n o 6 ö ò ó ô õ ø ñ
7	p q r s 7 \$ ß
8	t u v 8 ü ú û
9	w x y z 9
0	space 0 + £ \$ # *
*	*
#	Changes text entry mode (sentence case, upper, lower or numeric)

Assign a ringtone to a contact







You can assign a specific ringtone to a contact you have saved so the ringtone will play when that contact calls you.

1. From the home screen, press . Press  or  to display the contact you want to assign a specific ringtone to and then select **Options**.
2. Press  until **Assign ringtone** is displayed and press **OK**.
3. Press  or  to scroll through and listen to the available ringtones (Normal, Melody 1-15) and press **OK** to select the one you want. **Ringtone save** will be displayed.

View/dial a contact

1. From the home screen, press  to open your contact list.
2. Press  or  to scroll through and view the entries.
3. To dial an entry, press  when the entry is displayed.



Edit a contact

1. From the home screen, press .
2. Press  or  to scroll to the entry you want to edit and select **Options**.
3. Press  to display **Edit contact** and press **OK**.
4. Edit the name by pressing **Clear** to delete characters and use the keypad to enter new ones. Then press **Next** to display the number and edit if necessary, using **Clear** to delete unwanted digits and enter any new ones, then select **Save**.
5. Press  or  to choose between **VIP Off** or **On**. **All calls allowed** and select **OK**.



Searching alphabetically

You can alpha search for contact names by entering multiple characters, the search will be carried out on the beginning of the name only. e.g. enter Ja and names beginning with these two letters will be filtered. You can then scroll through the filtered list.



Delete a contact

1. From the home screen, press , then select **Options**.
2. Press  until **Delete contact** is displayed and press **OK**.
3. **Delete from all h/sets?** will be displayed, press **Yes** to confirm (or **No** to cancel). **Contact deleted** will be displayed.

Delete all contacts

1. From the home screen, press , then select **Options**.
2. Press  until **Delete all contacts** is displayed and press **OK**.
3. **Delete from all h/sets?** will be displayed, press **Yes** to confirm. **All contacts deleted** will be displayed.

View the contact memory status

1. From the home screen, press , then select **Options**.
2. Press  until **Memory status** is displayed and press **OK**.
3. The display will show how many contacts have been saved and the maximum number that can be saved e.g. 4 contacts (200 max.).

Speed dial



Save a Speed dial entry

1. From the home screen, enter the telephone number you want to store.

2. Then, either:



Press and hold the Speed dial button **1** to **9** you want to store the number under.

Or,

Select **Options**, scroll  to display **Set as speed dial** and press **OK**. Scroll  to the speed dial location number you want (1-9) and select **Save**.

The display will show **Saved as speed dial x** (x being the Speed dial button).



Dial a Speed dial entry

1. Either, press and hold the Speed dial button **1** to **9** under which the entry you want to dial is stored. Or, Select **Menu**, scroll  to display **Speed Dial List** and press **OK**. Scroll  to display the entry you want then press . The number will be dialled automatically.





You can allocate a name and number to each of the Speed dial buttons **1** to **9**. Button **1** is pre-programmed with 1571 but you can delete this and replace it with an entry of your choice. Once a Speed dial entry has been stored you can simply press and hold the Speed dial button to automatically dial the number stored under it.

If you try to save a Speed dial entry under a Speed dial button that has already been populated, the display will show **Replace number?** and you will hear an error tone. You can either overwrite the existing entry by selecting **Yes** or you can press and hold a different Speed dial button or select **No**.

Edit a Speed dial entry

1. Select **Menu**, scroll  to display **Speed Dial List** and press **OK**.
2. Press  or  to display the entry you want to edit and select **Options**.
3. **Edit speed dial** is displayed, press **OK**.
4. Edit the number by selecting **Clear** to delete digits and then enter any new digits. Select **Save**. **Saved as speed dial x** will be displayed.

Delete a Speed dial entry

1. Select **Menu**, scroll  to display **Speed Dial List** and press **OK**.
2. Press  or  to display the entry you want to delete and select **Options**.
3. Scroll  to display **Delete speed dial** and press **OK**.
4. **Are you sure?** is displayed, select **Yes**. **Speed dial x deleted** will be displayed.

Caller Display and the Calls list

Caller Display

If you've subscribed to a Caller Display service, you'll be able to see your caller's number on your handset display (provided it's not withheld) before you answer a call. If your caller's name is stored in your contacts list and it matches the number calling, you'll see the caller's name instead. If you haven't subscribed to a Caller Display service **Incoming call** will be displayed when you receive a call. If you receive a call from a number you have stored in your Blocked calls list **Blocked** will be shown on the top line of the display when you view the call in the calls list.

Calls list

The Calls list holds up to 50 incoming (missed and answered) calls and 30 outgoing calls. The date and time of the call is also stored. If you haven't subscribed to a Caller Display service, **No number** will be displayed in the Calls list for incoming calls but the time and date will still be recorded.

Calls are listed in chronological order with the most recently received/made call at the top of the list.

You'll need to subscribe to your network provider's Caller Display service for this feature to work. You might have to pay a fee. For more information on BT Calling Features, call BT free on 0800 800 150.

To make sure the caller's name is displayed, make sure you've stored the full telephone number in your contacts list, including the dialling code.

There are some incoming calls where a number is not displayed and a network message is recorded instead:

Unavailable = number is unavailable

Withheld = number has been withheld

International = international number

Operator = call from the operator

Payphone = call from a payphone

Ringback = a ringback call

Calls list indicators

Displayed on top line:

Missed = missed incoming call

Answered = incoming call received and answered





Dialled = outgoing call made

Blocked = blocked call (for incoming calls only)

Displayed next to the time:

 = caller left a voice message

Ⓜ = some part of the call was recorded





When the Calls list is open, press   to scroll from the newest call to the oldest, or press   to scroll from the oldest call to the newest.

When the list is full and a new call is received/made, the oldest entry will be deleted automatically. This is not Calls list memory.

Missed call notification

If an incoming call has been missed (i.e. not answered), the handset display will indicate this with the message **1 new call**. You can clear the notification by viewing the calls list on any handset registered to the base. The Missed notification will still be presented on the top line of the display for missed calls in the calls list so you can differentiate between calls. See Calls list indicators opposite.

View and access options in the Calls list



1. Press . The most recent entry is at the top of the list. (If there are no entries **Calls list empty** will be displayed.
2. Press   or  to scroll through and view the list.
3. To dial an entry, when the entry you want is displayed, press .

To play an answer message (if the missed caller leaves a message), when the entry you want is highlighted, select **Options, Play message** is displayed, press **OK**. The message will be played.

Block or Allow a calls list entry

To block or allow an entry in the calls list, scroll through the list and when the number you want is displayed, select **Options** and scroll  to either **Block number** or **Allow number** or **Block contact** or **Allow contact** for call list entry that displays contact names, press **OK** and follow the prompts.





Save a Calls list entry to your contacts

1. Press  then press  or  to display the entry you want and select **Options**.
2. **Save number** is displayed, press **OK**.
3. Enter the contact name and press **Next**.
4. The number will be displayed, (edit if necessary by selecting **Clear** to delete digits and enter any new ones).
5. Select **Save** to save the entry. You will be asked to choose the VIP status for this contact. Set it to **On. All calls allowed** or **Off**.

For more information and general advice on handling unwanted calls please go to bt.com/unwantedcalls

If you have more than one handset registered to the base, all data is synchronised across handsets. Therefore, if you save a calls list entry to your contacts it will be saved on all handsets.

Delete an entry in or the entire Calls list



1. Press , then if you want to delete just one entry, press  or  to display the entry and select **Options**.
2. Press  to display either **Delete call** or **Delete all calls** and press **OK**. **Call deleted** will be displayed if you have deleted one entry, if you chose to delete all then you will need to confirm by selecting **Yes**.

Answer machine



Your BT4600 can digitally record up to 60 minutes of messages. You can operate your answer machine from: the handset, the base or remotely from any other Touchtone™ telephone (see page 64).

Using the answer machine from the handset

Switch the answer machine on or off

1. Select **Menu, Answer Phone** is displayed, press **OK**.
2. Press  until **Ans. phone on/off** is displayed, press **OK**.
3. Press  or  to display **On** or **Off** and press **OK** to select. **Ans.phone on** or **Ans.phone off** will be displayed and announced to you.

Set the answer mode

1. Select **Menu, Answer Phone** is displayed, press **OK**.
2. Press  until **Answer mode** is displayed and press **OK**.
3. Press  or  to select **Answer & record** or **Answer only** and press **OK**. **Saved** will be displayed and the answer mode will be announced.

When the answer machine is switched on, the text **On** will light up on the  button.

The default answer mode is **Answer & Record** using the female voice.

Answer & Record

The pre-recorded Answer & Record outgoing message that allows your caller to leave a message is, “Hello, your call cannot be taken at the moment, so please leave your message after the tone”.

Answer Only

The pre-record Answer Only outgoing message, where callers hear an announcement but can't leave a message, is “Hello, your call cannot be taken at the moment and you cannot leave a message, so please call later”.



When recording your Answer Only message, remember to let your caller know that they won't be able to leave a message.

The default outgoing message mode is Answer & Record using the female voice.





Outgoing messages

The outgoing message is the message a caller first hears when the answer machine picks up their call. There are two pre-recorded male and female outgoing messages to choose from, one that allows callers to leave a message (Answer & Record) and one that simply answers the call (Answer Only) or you can record your own.



Record your own outgoing message

1. Select **Menu**, **Answer Phone** is displayed, press **OK**.
2. Press  until **Outgoing message** is displayed and press **OK**.
3. Press  or  to display the outgoing message mode you want: **Answer & record** or **Answer only** and press **OK**.
4. **Record message** is displayed, press **OK**.
Follow the voice prompt to record your message and select **Save** when you've finished.
5. Your message will be played back to you. Select **OK** if you're happy with it or you can delete it by selecting **Delete**.

Play the current outgoing message





1. Select **Menu, Answer Phone** is displayed, press **OK**.
2. Press  until **Outgoing message** is displayed, press **OK**.
3. Press  or  to display the outgoing message mode you want: **Answer & record** or **Answer only** and press **OK**.
4. Press  to display **Play message** and press **OK** to hear the outgoing message. If the current outgoing message being played is your recorded message you can delete it if you want to by selecting **Delete**.

Reinstate the pre-recorded outgoing message

1. Select **Menu, Answer Phone** is displayed, press **OK**.
2. Press  until **Outgoing message** is displayed, press **OK**.
3. Press  or  to display the outgoing message mode you want: **Answer & record** or **Answer only** and press **OK**.

Reinstating the pre-recorded outgoing message will not delete your recorded outgoing message. It will be retained in case you want to use it in the future.

You can record a memo message on the answer machine for other users to hear when they listen to messages. You can only record memos using the handset. Memo messages are played back in exactly the same way as normal answer machine messages, see page 56, 59 and 62.

4. Press  to display **Use default message** and press **OK**.
5. Press  or  to display **On** and press **OK**. Press  or  to display **Female voice** or **Male voice** and press **OK**. **Saved** will be displayed.





Record a memo

1. Select **Menu, Answer Phone** is displayed, press **OK**.
2. Press  until **Record memo** is displayed, press **OK**.
3. Follow the voice prompt to record your memo and select **Save** when you've finished.
4. Your memo will be played back to you. Select **OK** if you're happy with it or you can delete it by selecting **Delete**.

Answer delay





The answer delay setting sets how many times the phone will ring before the answer machine takes the call. You can choose from 2-10 rings or Time saver. The default setting is 5 rings.

Set the answer delay

1. Select **Menu, Answer Phone** is displayed, press **OK**.
2. Press  until **Answer settings** is displayed, press **OK**.
3. Press  or  to display either **Answer & record** or **Answer only** and press **OK**.
4. **Answer delay** is displayed, press **OK**. Press  or  to display the number of rings you want (2-10 rings or Time saver) and press **OK**. **Saved** will be displayed.

Set the maximum message length

You can set the maximum length that an answer machine message can be: 1 minute, 2 minutes or 3 minutes. The default setting is 3 minutes.

1. Select **Menu, Answer Phone** is displayed, press **OK**.
2. Press  until **Answer settings** is displayed, press **OK**.
3. **Answer and record** is displayed, press **OK**.
4. Press  to display **Maximum msg length** and press **OK**. Press  or  to select the length you want and press **OK**. **Saved** will be displayed.

Time saver

When you ring in to access your answer machine remotely, if you have set Time saver as the answer delay and you have new messages it will answer after 10 seconds. If you don't have new messages it will answer after 20 seconds. This means you can hang up knowing that you have no new messages, saving you the time and the cost of the call.

For compatibility with BT 1571 (or another voicemail service)





Make sure the answer delay is set for your answer machine to answer before the voicemail to answer before the voicemail service. Therefore, the answer delay should be less than on your voicemail service. For BT 1571 do not set the answer delay to more than 5 rings.

58 Answer machine

When the message alert is set to On, the base will beep at regular intervals. The default setting is On.

The default setting is call screening Off.





Set the message alert on or off

1. Select **Menu, Answer Phone** is displayed, press **OK**.
2. Press  until **Answer settings** is displayed, press **OK**.
3. **Answer and record** is displayed, press **OK**.
4. Press  to display **Message alert** and press **OK**. Then press  or  to display **On** or **Off** and press **OK**. **Saved** will be displayed.

Handset Call screening

When call screening is turned on and the answer machine takes a call, you can listen to the caller leaving a message on your handset. You can then identify the caller and decide whether to take the call in person.

Turn call screening on or off



1. Select **Menu, Answer Phone** is displayed, press **OK**.
2. Press  until **Answer settings** is displayed, press **OK**.
3. Press  to display **Call screening** and press **OK**.
4. Press  or  to display **On** or **Off** and select **OK**. **Saved** will be displayed.

Using call screening

When the phone rings, wait for the answer machine to take the call. When the caller begins to leave a message the left soft key will be labelled **Listen**, press **Listen** to listen to the caller leaving a message or press **End** to stop listening in. If you want to talk to the caller, press  to take the call. This will stop the recording if it's started.

Message playback using the handset

- From the home screen, select **Play**.
Or
Select **Menu, Answer Phone** is displayed, press **OK**. Press  to display **Play all messages** and press **OK**.
- Your messages will start to play and the handset will display the number or the name if you have Caller Display and a name/number match and the time and date it was received. If you have any old (already listened to messages) these will be played after your new messages.
- During playback, you can select **Delete** to delete the message or **Stop** to stop message playback.

While screening, you can adjust the volume by pressing  or  on the handset if you are screening the call on the handset or  on the base if you are screening the call on the base.

You can also stop a caller leaving a message by pressing  on the base during message recording. The caller will hear, "Thank you for calling", and the call is automatically ended.

When you receive new messages, the home screen will display the number of messages stored. The message counter on the base will flash and the message alert will beep if message alert is set to on.

The number of messages displayed on the handset includes all messages stored, new and old (played). When a message is deleted the display message will be updated accordingly.

Each message is played back with the day, date and time it was received announced.

60 Answer machine

New (unplayed) messages are played first (oldest to most recent) and then old (played) messages (oldest to most recent).

You can still enter the answer phone menu and playback your messages, however, you will see a warning message **Memory full**. **No messages can be left** before you enter the menu and **Memory full** will be announced before new or old messages are played back.



Message playback is stopped if you receive an incoming call.

You can toggle between private playback through the handset and handsfree playback by pressing the  button. The default is private playback.

You can't delete messages that you've not played yet.

Unless you delete a message, it's automatically saved.

During playback you have the following options:

 **Vol.** or  **Calls** to adjust the playback volume.

 to switch private playback through the handset to handsfree playback.

1 once to repeat the current message playing from the beginning.

3_{DEF} to delete the message.



4_{GHI} twice within a second to skip back to the previous message.

6_{MNO} once to skip forward to the next message.

 **Ringer** press to replay the message slowly.

At the end of playback, you will hear, “End of messages,” and the same message will be displayed on the message indicator. The home screen will be renumbered to take into account any deleted messages.



Delete a message

1. Select **Menu, Answer Phone** is displayed, press **OK**.
2. **Messages <x new>** is displayed, press **OK**.
3. Press  or  to display the message you want to delete then press **Options**.
4. Press  to display **Delete message** and press **OK**. **Are you sure?** will be displayed if it's an old message or **Without listening?** if it's a new message, press **Yes** to confirm.

Delete all old (played) messages

1. Select **Menu, Answer Phone** is displayed, press **OK**.
2. Press  to display **Delete old msgs** and press **OK**.
3. **Are you sure?** is displayed, select **Yes** to confirm (or **No** to cancel).

Save a number in the answer phone message list to your contacts

1. Select **Menu, Answer Phone** is displayed, press **OK**.
2. **Messages <x new>** is displayed, press **OK**. Press  or  to display the number you want to store then press **Options**.
3. Press  to display **Save number** and press **OK**.

To cancel deletion, when you see the confirmation question, select **No**.

When the answer machine is switched On, the text 'On' will light up on the  button.

Memory full

If there is only 10 seconds of memory capacity left when a caller is leaving a message they will hear, "Please complete your message within 10 seconds." If a caller is still leaving a message when the memory expires they will hear, "Memory full. Thank you for calling", and the call will be ended.



4. Enter the contact name and press **Next**.
5. The number will be displayed, (edit if necessary by selecting **Clear** to delete digits and enter any new ones). Select **Save** to save the entry.

Using the answer machine from the base

Switch the answer machine on or off

Press  to toggle between **On** and **Off**. The setting is announced.

Message playback using the base

Press  or  to play messages back slowly. If you have messages they will be played, new (unplayed) messages first followed by old (played) messages.

During playback:

Press  to stop playback. The base will return to idle.

Press  to pause and resume playback.

Press  to delete the message being played.

Press  to skip forward to the start of the next message.



Press  to skip back to the start of the current message.

Press  twice to skip back to the start of the previous message.

Press  to increase or decrease the playback volume level.

At the end of playback the base will return to idle mode and messages will be renumbered to take into account any deleted messages.

Delete all old (played) messages

1. In idle mode, press . The base will announce, “To delete all old messages, press Delete”, press  again within 3 seconds to delete all old messages. You will hear, “All old messages deleted.”

If your answer machine memory becomes full and it is set to Answer and record it will automatically switch to Answer only mode. Once messages have been deleted and there is memory available again, the machine will revert to Answer and record mode (unless you have changed the mode yourself to Answer only using the handset menu).

You will need to delete messages before your answer machine will be able to record new ones. To delete old (played) messages, see pages 61 and 63.



If you don't press  within 3 seconds you will hear, “Messages saved”.

If you have already changed the access PIN when setting your Outgoing call control then you will not need to set it again as this PIN is used for both Call control and Remote access.



Remote access

With remote access you can operate your answer machine from any Touchtone™ phone, even if you forget to turn on your answer machine before you go out. You need to set a remote access PIN first and then you will need to turn remote access On if you want to use this feature.





Set the remote access PIN for the first time

1. Select **Menu, Answer Phone** is displayed, press **OK**.
2. Press  until **Answer settings** is displayed, press **OK**.
3. Press  to display **Remote access** and press **OK**. Follow the instructions to set your PIN or enter your PIN and select **OK**.
4. **New PIN:** is displayed. Enter a 4 digit PIN of your choice and select **OK**.
5. **Confirm PIN:** is displayed. Enter the 4 digit PIN again and select **OK**. The display will show **New PIN saved**.

Change the remote access PIN

1. Select **Menu, Answer Phone** is displayed, press **OK**.
2. Press  until **Answer settings** is displayed, press **OK**.
3. Press  to display **Remote access** and press **OK**.
4. Press  to display **Change PIN** and press **OK**.
5. Enter your old 4 digit PIN and select **OK**.
6. Enter the new 4 digit PIN, select **OK**, then enter the new PIN again and select **OK**. The display will show **New PIN saved**.

Turn remote access on or off

1. Select **Menu, Answer Phone** is displayed, press **OK**.
2. Press  until **Answer settings** is displayed, press **OK**.
3. Press  to display **Remote access** and press **OK**.
4. **On/Off** is displayed, press **OK**.
5. Press  or  to display **On** or **Off** and select **OK**. **Saved** will be displayed.

If you forget to switch on your answer machine

1. Call your number from another landline phone and let it ring. After 20 rings the answer phone will answer the call.

Select **Clear** if you need to delete any digits.

You cannot turn Remote access On until you have set a remote access PIN.

The default setting is Off.

Remote Access must first be enabled to allow you to switch on the answer machine remotely.

2. When you hear the announcement, press ***** and enter your 4 digit remote access PIN when prompted. Your answer phone will announce if you have any messages before playing remote access options. If you do not choose to switch your answer machine On, it will switch off when the call is ended.

Operating you answer machine remotely

1. Dial your phone number.
2. When you hear your outgoing message, press ***** and enter your 4 digit remote access PIN.
3. Follow the voice prompts to:

To hear the main menu, press **0**.

To replay the current message, press **1**.

To play all messages, press **2**.

To delete during messages, press **3**.

To skip back during messages, press **4**.

To set answer on (or off), press **5**.

To skip forward during messages, press **6**.

To play your outgoing message, press **8**.





To record a new outgoing message, press **9**.

To set to answer only (or answer and record), press **#**.





Settings

Handset settings

Set the handset ringtone for external or internal calls

1. Select **Menu**, scroll  to display **Settings** and press **OK**.
2. **Sounds** is displayed, press **OK**. **Ringing** is displayed, press **OK**.
3. Press  or  to display either **External ringtone** or **Internal ringtone** and press **OK**.
4. Press  or  to display and listen to the melodies and press **OK** to select your choice. **Saved** will be displayed.

Set the handset ringer volume

1. Select **Menu**, scroll  to display **Settings** and press **OK**.
2. **Sounds** is displayed, press **OK**. **Ringing** is displayed, press **OK**.
3. Press  to display **Ringing volume** and press **OK**. Press  to increase the volume or  to decrease or turn the ringer off. Press **OK** to save.

Choose from 15 handset ringtones: 10 polyphonic and 5 standard. The default external ringtone is Melody 1 and the internal ringtone is Melody 2.

There are 5 handset ringer volume levels plus Ringer Off. The default setting is Level 3. If you turn the ringer off, the  icon will be displayed on the home screen.

As a quick way to turn the handset ringer off, press and hold .





There are two handset tones: keypad tones and confirmation tones. You can turn these on or off, the default setting is On.

Keypad tones: when turned on, you will hear a beep after each button press.







Confirmation tones: when turned on, you will hear a tone after each successful action or after an error has occurred. This does not include the battery charging tone when the handset is placed on the base/charger, low battery or out of range warnings or tones used in calls such as Call Waiting or Call Intercept.

There are 5 contrast levels to choose from. The default setting is Level 3.

Adjust the handset ringer tone



1. Select **Menu**, scroll  to display **Settings** and press **OK**.
2. **Sounds** is displayed, press **OK**. Press  to display **Tone adjustment** and press **OK**.
3. Press  or  to display either **Standard**, **Increase treble** or **Increase bass** and press **OK**. **Saved** is displayed.

Turn the handset tones on or off





1. Select **Menu**, scroll  to display **Settings** and press **OK**.
2. **Sounds** is displayed, press **OK**. Press  to display **Handset tones** and press **OK**.
3. Press  or  to display **Keypad tones** or **Confirmation tones** and press **OK**.
4. Press  or  to display **Tones on** or **Tones off** and press **OK**. **Saved** is displayed.

Change the handset display contrast



1. Select **Menu**, scroll  to display **Settings** and press **OK**.
2. Press  to display **Display** and press **OK**.

3. **Contrast** is displayed, press **OK**.
4. Press  or  to select the level you want, then select **OK**.

Turn the screensaver on or off

1. Select **Menu**, scroll  to display **Settings** and press **OK**.
2. Press  to display **Display** and press **OK**.
3. Press  to display **Screen saver** and press **OK**.
4. Press  or  to display **On** or **Off** and press **OK** to save.

Change the handset name

1. Select **Menu**, scroll  to display **Settings** and press **OK**.
2. Press  to display **Handset name** and press **OK**.
3. Edit the name by selecting **Clear** to delete the characters, then enter the new name and select **Save**.

Change the call settings





1. Select **Menu**, scroll  to display **Settings** and press **OK**.
2. Press  to display **Call settings** and press **OK**.

A handset name can be a maximum of 12 characters. If you name your handset, the handset number will be removed, e.g. instead of saying **Kitchen 1** the name would just be **Kitchen**. To revert back to the default handset name (Handset x), delete all the characters and select **Save**.

If Auto answer is set to On you can answer a call by lifting the handset off the base. If it's set to Off, you'll need to lift the handset off the base and then press . If Auto end is set to On you can end a call by placing the handset back in the base.

If Auto end is set to Off, you'll need to press  to end the call.





With Auto join calls set to On you can automatically join an existing call from another registered handset without being invited to join the call, you can simply press  to join.

3. Press  or  to display either **Auto answer**, **Auto end call**, **Auto join calls** or **First ring** and press **OK**.
4. Press  or  to display **On** or **Off** and press **OK** to save.

Base settings





Set the base ringtone melody

Choose from 5 base ringtones. The default is Melody 1.

1. Select **Menu**, scroll  to display **Settings** and press **OK**.
2. Press  to display **Base settings** and press **OK**.
3. **Ringtone** is displayed, press **OK**.
4. **Ringtone** is displayed, press **OK**. Press  or  to display and listen to the melodies and press **OK** to save your choice.

Set the base ringer volume



There are 5 base ringer volume levels plus Ringer off. The default is Level 3.

1. Select **Menu**, scroll  to display **Settings** and press **OK**.
2. Press  to display **Base settings** and press **OK**.
3. **Ringtone** is displayed, press **OK**.
4. Press  to display **Ringtone volume** and press **OK**. Press  to increase the volume or  to decrease or turn the ringer off. Press **OK** to save.



PBX access code

If you're connected to a switchboard, you might need to enter an access code (e.g.9) before each number is dialled. Your BT4600 can store an access code which is automatically dialled before each number.

Set a PBX access code

1. Select **Menu**, scroll  to display **Settings** and press **OK**.
2. Press  to display **Base settings** and press **OK**.
3. Press  to display **PBX code** and press **OK**.
4. Enter the number you want (maximum of 4 digits) and select **Save**.

Change the system PIN

1. Select **Menu**, scroll  to display **Settings** and press **OK**.
2. Press  to display **Change system PIN** and press **OK**.
3. If the current PIN is 0000, you will be prompted to enter the new 4 digit PIN, then press **OK**. (Or, if the current PIN is not 0000, you will be prompted to enter the old (current) 4 digit PIN first and then select **OK**. Then follow the prompts and enter the new 4 digit PIN).
4. Enter the new 4 digit PIN again and select **OK**. The display will show **New system PIN saved**.

With First ring set to Off, an incoming external call will be displayed visually before the handset(s) start to ring for the second burst of ringing.

If you wish to revert to not using a PBX access code, you need to go into the PBX code menu and delete all the digits by selecting **Clear**, then select **Save**.

The default system PIN is 0000. You can change this to your own preferred 4-digit code.

The system PIN is used for registration/de-registration.



If you make a mistake, select **Clear** to delete a digit.

If you reset the handset settings all the handset settings will return to their default settings, e.g. the handset name, ringer melody, all volume levels, display and alarm settings.



If you reset the base settings all the base settings will return to their default settings, e.g. the base ringer melody, all volume levels, PBX access codes and answer machine settings.

If you delete the handset and base user data all your contacts and the calls list will be deleted and your recorded outgoing messages and all received answer machine messages will be deleted.

Reset the handset or base settings



1. Select **Menu**, scroll  to display **Settings** and press **OK**.
2. Press  to display **Reset** and press **OK**.
3. **Handset settings** is displayed, press **OK** or press  to display **Base settings** and then press **OK**.
4. **Handset settings?** or **Base settings?** is displayed, select **Yes**.
5. **Resettings settings** is displayed while the reset takes place. Once finished **<Handset or Base> settings reset** is displayed.

Delete the handset and base user data





1. Select **Menu**, scroll  to display **Settings** and press **OK**.
2. Press  to display **Reset** and press **OK**.
3. Press  to display **Delete user data** and press **OK**.
4. **Delete from all h/sets?** is displayed, select **Yes** to confirm (or **No** to cancel).
5. **Deleting user data...** is displayed. Once finished, **All user data deleted** is displayed.

Clock/Alarm

Set the time and date

1. Select **Menu**, scroll  to display **Clock/Alarm** and press **OK**.
2. Press  to display **Time & date** and press **OK**.
3. Use the keypad to enter the time using the 24 hour clock format e.g. for **3:32 pm** you need to enter **15:32**. press **Next**.
4. Enter the date in the format **DD/MM/YYYY**.
5. Press **Save**. **Saved** is displayed.

Set an alarm

1. Select **Menu**, scroll  to display **Clock/Alarm** and press **OK**.
2. **Alarm** is displayed, press **OK**.
3. Press  or  to display the alarm frequency you want: **Off**, **On once**, **On daily**, **Monday to Friday** or **Saturday & Sunday** then press **OK**.
4. Enter the alarm time and select **Save**. Press  or  to select the alarm melody and press **OK**. **Alarm on <time>** is displayed.

The clock is displayed in 24 hour format

You must enter the full date: day, month and year.

If you select Off the display will show Alarm off and you will hear a confirmation tone.

If you set an alarm the display will show the time after you select Save.

If an incoming call is received while the alarm is going off, the alarm notification will immediately stop and the incoming call will be shown on the display. The alarm will not resume.

Stopping the alarm when it goes off

When the alarm goes off, the selected melody will play at an ascending volume, the handset backlight will flash and the display will show the alarm time. The alarm will sound for 30 seconds and then the handset will return to idle, if the alarm isn't stopped or set to snooze, it will sound once more after 1 minute.

To stop the alarm, press  or select **Stop**.

To activate a ten minute snooze, select **Snooze** or any other button (except  or **Stop**). You can set snooze as many times as you want until you select **Stop**.







BT Calling Features

You can easily access a number of BT Calling Features using the Calling Features menu.

Pre-stored numbers in the Calling Features menu

Call Diversion	Call Waiting
Cancel Ringback	Call Barring

Using Call Diversion: set up, cancel or check status

1. Select **Menu**, scroll  to display **Calling Features** and press **OK**.
2. **Call diversion** is displayed, press **Options**.
3. Press  or  to display the diversion option you want: **Divert all calls**, **Divert when busy** or **Divert if unanswered** and press **OK**.
4. Press  or  to display either: **Set up diversion**, **Cancel diversion** or **Check diversion** and press **OK**.
5. If you selected **Set up diversion**, you will need to enter the telephone number to divert to (or press  and select the number from your contacts), then select **Set up**. If you chose **Cancel diversion** or **Check diversion**, the service will be called, follow the spoken instructions or listen for confirmation/status.

You need to subscribe to the specific BT Calling Feature to be able to use some of these services. You might have to pay a fee.

For more details on BT's Calling Features, go to bt.com/callingfeatures, refer to the user guide supplied when you subscribed to the services of your choice or call BT free on 0800 800 150.



If you're not connected to the BT network, some of these features may not be available. Call diversion services might allow other divert options. Please contact your telephone network provider for details.

Call Diversion will divert incoming calls to another number of your choice. You can choose all calls to be diverted or calls only to be diverted when the line is busy or only calls that are not answered.





With the ring back feature you can get an automatic call back from an engaged number. No need to dial a busy number over and over again. Just dial 5 on hearing the engaged tone, wait for a confirmation message and hang up. Your phone will keep trying the busy number for up to 45 minutes.

Call Waiting lets you know if another person is trying to call you while you're on another call. If a second caller rings, you will hear a beep in the handset earpiece. If you've subscribed to Caller Display, the display will show the caller's details as well.







Cancel Ringback

1. Select **Menu**, scroll  to display **Calling Features** and press **OK**.
2. Press  display **Cancel Ringback** and press **OK**.
3. The service will be called and the display will show **Cancelling**. Follow the spoken instructions or listen for confirmation/status.

Using Call Waiting

1. Select **Menu**, scroll  to display **Calling Features** and press **OK**.
2. Press  until **Call waiting** is displayed, press **Options**.
3. Press  or  to display either **Turn on**, **Turn off** or **Check** and press **OK**. The service will be called. Follow the spoken instructions or listen for confirmation/status.

Using call barring

1. Select **Menu**, scroll  to display **Calling Features** and press **OK**.
2. Press  until **Call barring** is displayed and press **Options**.
3. Press  or  to display either: **Set up barring**, **Cancel barring** or **Check barring** and press **OK**.
4. If you selected **Set up barring** you will need to press  or  to display the type of calls you want to bar then press **OK**. If you selected **Cancel** or **Check barring** the service will be called. Follow the spoken instructions or listen for confirmation/status.

The type of calls you can bar are:

All outgoing calls

National, International & Mobile calls

International calls

Operator calls/texts

* and # calls

Premium rate calls

Internat'l is short for International

Using additional handsets

You can register up to 6 GAP compliant handsets to your BT4600 base to extend your phone system without needing to install telephone extension sockets for each new phone.

If a handset becomes un-registered it will need to be registered to the base again. **Register handset** will be displayed, select **OK** then follow the instructions starting from point 4 below.



You have 2 minutes to complete the registration process. After 2 minutes the In use light on the base will stop flashing.

If registration isn't successful the first time, please try again in case the base registration period ran out of time.





If there are already 6 handsets registered to the base, the registration will fail. You must de-register another handset before you can register the new one.

If you've bought a BT4600 multiple pack, any additional handsets come pre-registered to the base. However, if you purchase an additional handset separately, you must register it to your BT4600 base before it can be used.

Register an additional handset

1. Select **Menu**, scroll  to display **Settings** and press **OK**.
2. Press  to display **Registration** and press **OK**.
3. **Register handset** is displayed, press **OK**.
4. Press and hold  on the base until you hear a beep and the In use light starts to flash.
5. The handset will display **Registering handset...** to indicate the base is in registration mode. If the system PIN is not 0000 then you will be prompted to enter it, then select **OK**.
6. Once registration is successful the handset will show **Handset x registered** (with X being the assigned handset number). The handset will then synchronise data with any other registered handsets, e.g. contacts, speed dials.

De-register a handset

1. Select **Menu**, scroll  to display **Settings** and press **OK**.
2. Press  to display **Registration** and press **OK**.
3. Press  to display **Deregister HS** and press **OK**.
4. Press  or  to display the handset you wish to de-register and press **Select**.
5. If the system PIN is not 0000 then you will be prompted to enter it, then select **OK**. If it is 0000, you will continue straight to point 6.
6. The display will show will show **Please wait....** and once successful **De-registered**.

Registering another make of handset to your BT4600 base

If you want to register another make of handset (i.e. not a BT4600 handset) to your BT4600 base you will need to follow the Registration instructions that came with the handset first and then continue with the base part of the registration procedure (as shown in point 4 on page 78). Please note that registering other types of handset will only provide limited compatibility i.e. you may only be able to make and receive calls on the additional handset.

80 Using additional handsets





You can also choose All handsets if you want to call all handsets registered to the base. If a handset answers, the handset name will be displayed on your screen.

If an external call is received while an internal call attempt is being made, the internal call will be abandoned and all handsets registered to the base will ring and display the external call information.

If the internal call is not answered after 30 seconds you will see **Handset unavailable** on your display and you will be returned to your external caller.



Make an internal call between handsets

If you have more than one handset registered to the base, you can make internal calls between two handsets.

1. Press , then press  to scroll through and display the handset you want to call, then press .
2. The receiving handset will ring and your handset name will be presented on the screen. To answer they need to press . If it is not answered after 30 seconds, you will see **Handset unavailable** on your display.
3. Press  to end the call.

Transfer a call



You can transfer an external call to another handset registered to the base.

1. During a call, select **Options**, then press  to display **Transfer call** and press **OK**.
2. If you have one other handset it will ring, if you have more than one handset you can press  or  to display the handset you want, then select **Call** and it will ring. Your external call will be put on hold.

3. When the other handset answers you can announce the call and then select **Trans** or press  to transfer the call.

Hold a 3-way call

Using your handset, you can hold a 3-way call with two external callers. Or, you can hold a 3-way call between 2 internal handsets and 1 external caller. Once the 3-way call is in progress other handsets registered to the base can join the call by pressing .

1. During a call, select **Options. Multi call** is displayed, press **OK**.
2. Either enter the number you want to call or press  and scroll to the number you want or the internal handset you want and then press  to call. When the second call is answered, the first external caller will be put on hold.
3. Select **Join** and all callers will be joined in a 3-way call.

Phone doesn't work

- Have you activated the batteries correctly? See page 8.
- Check that the mains power is correctly connected.

No dial tone or line cord error message displayed on screen

- Is the telephone cord plugged into the base and phone wall socket?
- Check that the mains power is correctly connected.
- Only use the telephone cord supplied with the phone.

Can't make or receive calls

- Check that the mains power is correctly connected.
- The batteries may need recharging.
- Check that product call barring is not active – see page 77.
- Has there been a power cut? If so, place the handset back on the base for ten seconds and try again. If it still doesn't work, disconnect the batteries and mains power for ten minutes, then reconnect and try again.

You have a dial tone, but the phone won't dial out

- If you're connected to a switchboard, check whether you need to dial an access code, see page 71.

Handset doesn't ring

- The ringer volume may be switched off, see page 67.
- Check that the mains power is correctly connected.
- Do Not Disturb may be switched on, see page 39.
- Block nuisance calls may be switched on, see page 22.
- Make sure the handset is registered to the base, see page 78.

No display

- The batteries may be flat, dead or incorrectly inserted.
- Recharge or replace the batteries.
- Make sure the handset is registered to the base, see page 78.
- Check that the mains power is correctly connected to the base.
- Check that the handset is within range of the base.
- If the batteries are low, place the handset on the base/charger to recharge.

You hear the busy tone when you press

- Make sure the handset is in range of the base.
- Another handset registered to your BT4600 base may be on the line and Auto Join is switched off, please see page 70.

Answering machine doesn't record any messages

- The memory may be full. Play and delete old messages, pages 59-60 and 61-62.

Answering machine messages have the wrong date and time

- Have you set the date and time? See page 73.

Can't access your messages from another phone

- Have you changed the remote access PIN? See page 64.
Always keep a note of the new PIN in a safe place.
- Has Remote access been turned off? To turn remote access on, see page 64.

No Caller Display number/name displayed

- Have you subscribed to a Caller Display service from your network provider? See page 49.
- The caller may have withheld their number.
- Network may not have the callers number information.
- An exact name/number match was not found in your contacts. Check that you've stored the full STD dialling code.

Can't register a handset to a base

- You can register up to six handsets to your BT4600 base. Check that you've not exceeded the limits.
- Check that you've entered the correct system PIN number (default PIN 0000).
- Check that you're at least one metre away from other electrical equipment to avoid interference when registering.

Base unit does not ring, but the lights are on

- Have you connected the telephone line correctly?
- Do Not Disturb may be switched on, see page 39.
- Block nuisance calls may be switched on, see page 22.
- Is the base ringer set to off?
- You may have a faulty line or socket. Try using another socket or line.
If you are a BT customer then please call 0800 800 151 or your network provider if you still have problems.

Buzzing noise on my phone or on other electrical equipment nearby

- Sometimes other electrical equipment can interfere with your BT4600 if it's placed too close. We recommend that you place your BT4600 at least one metre away from electrical appliances or metal obstructions to avoid any risk of interference.

Customer Helpline

If you're still having problems, call us on **0800 145 6789*** or go to **bt.com/producthelp**

General sales enquiries

- BT Residential lines – call **150**. BT Business lines – call **152**.
- For non BT line customers, call **0800 800 150** (residential) or **0800 800 152** (business).
- Additional handsets available to purchase from the Helpdesk on **0800 145 6789***.

Billing enquiries

Please see the phone number shown on your BT bill.

General information

Important

This equipment is not designed for making emergency phone calls when the power fails. Alternative arrangements should be made for access to emergency services.

This product is intended for connection to analogue public switched telephone networks and private switchboards in the United Kingdom.

Replacing the handset batteries

After a time, you might find that the handset batteries run out of charge more quickly. This is a standard sign of wear and the batteries will need replacing.

1. Open the battery compartment cover.
2. Lift the battery out and remove the batteries. Replace with two new AAA Ni-MH 550mAh rechargeable batteries.
3. Replace the battery compartment cover.

Caution

Don't immerse batteries in water, throw them into a fire or dispose of them with ordinary domestic refuse. BT accepts no responsibility for damage caused to your BT4600 by using any other types of batteries. There is a risk of explosion if incorrect batteries are fitted.

Safety information

- Only use the power supply suitable for the BT4600. Using an unauthorised power supply will invalidate your guarantee and may damage the phone. The item

code for the base mains power supply is 066270 . If you've bought a multiple pack, the item code for the charger mains power supply is 066270.

- Use only the approved rechargeable batteries supplied. Spare rechargeable batteries are available from the BT4600 Helpline on 0800 145 6789*.
- Don't open the handset (except to replace the handset batteries) or the base. This could expose you to high voltages or other risks. Contact the Helpline on 0800 145 6789* for all repairs.
- If the keypad is locked, it is still possible to make calls to 999 and 112 emergency numbers by dialling the number then pressing .
- Radio signal transmitted between the handset and base may cause interference to hearing aids.
- It is recommended that advice from a qualified expert be sought before using this product in the vicinity of emergency/intensive care medical equipment.
- It is recommended that if you have a pacemaker fitted you check with a medical expert before using this product.
- Your product may interfere with other electrical equipment, e.g. TV and radio sets, clock/alarms and computers if placed too close.
- It is recommended that you place your product at least one metre away from such appliances to minimise any risk of interference.

- Never dispose of batteries in a fire. There is a serious risk of explosion and/or the release of highly toxic chemicals.

Cleaning

- Clean the handset and base (or charger) with a damp (not wet) cloth, or an anti-static wipe. Never use household polish as this will damage the product. Never use a dry cloth as this may cause a static shock.

Environmental

- Do not expose to direct sunlight.
- The handset may become warm when the batteries are being charged or during prolonged periods of use. This is normal. However, we recommend that to avoid damage you do not place the product on any surface susceptible to heat damage.
- Do not stand your product on carpets or other surfaces which generate fibres, or place it in locations preventing the free flow of air over its surfaces.
- Do not submerge any part of your product in water and do not use it in damp or humid conditions, such as bathrooms.
- Do not expose your product to fire, explosive or other hazardous conditions.
- There is a slight chance your phone could be damaged by an electrical storm. We recommend that you unplug the power and telephone line cord during an electrical storm.

How to recycle your equipment

The symbol shown here and on the product means that the product is classed as electrical or electronic equipment, so DO NOT put it in your normal rubbish bin.



It's all part of the Waste Electrical and Electronic Equipment (WEEE) Directive to recycle products in the best way – to be kinder to the planet, get rid of dangerous things more safely and bury less rubbish in the ground.

You should contact your retailer or supplier for advice on how to dispose of this product in an environmentally friendly way.

Warning

You won't be able to call 999 from this phone if there's a power cut, so make sure you've got another way to call for help in an emergency.

Guarantee

Your BT4600 is guaranteed for 12 months from the date of purchase.

Subject to the terms listed below, the guarantee will provide for the repair of, or at BT's or its agent's discretion, the option to replace the BT4600 or any component thereof, (other than batteries), which is identified as faulty or below standard, or as a result of inferior workmanship or materials. Products over 28 days old from the date of purchase may be replaced with a refurbished or repaired product.

Guarantee conditions

- The guarantee shall only apply to defects that occur within the 12 month guarantee period.
- Proof of purchase is provided.
- The equipment is returned to BT or its agent as instructed.
- This guarantee doesn't cover any faults or defects caused by accidents, misuse, fair wear and tear, neglect, tampering with the equipment, or any attempt at adjustment or repair other than through approved agents.
- This guarantee does not affect your statutory rights.

Within the 12 month guarantee period

Prior to returning your product, please read the Help section beginning on page 82 or contact the BT4600 Helpline on **0800 145 6789***. Additional answers to frequently asked questions are available from **bt.com/producthelp**

In the unlikely event of a defect occurring, the helpdesk will issue a Fault Reference Authorisation (FRA) number and instructions for replacement or repair. Please note you will need the FRA number before returning the product. This does not affect your statutory rights.

Outside of the 12 month guarantee period

If your product needs repair after the guarantee period has ended, the repair must meet the approval requirements for connection to the telephone network. We recommend that you contact BT's recommended repair agent Discount Communications on **0800 980 8999** or a local qualified repairer.

Returning your phone

If the Helpline is unable to remedy your problem they will issue a Fault Reference Authorisation number and ask you to return the product to your original place of purchase. Where possible, pack the product in its original packaging. Please remember to include all parts, including the line cords, power supply units and the original batteries.

Technical information

How many telephones can I have?

All items of telephone equipment have a Ringer Equivalence Number (REN), which is used to calculate the number of items which may be connected to any one telephone line. Your BT4600 has a REN of 1. A total REN of 4 is allowed. If the total REN of 4 is exceeded, the telephones may not ring. With different telephone types there is no guarantee of ringing, even when the REN is less than 4.

Any additional handsets and chargers that you register have a REN of 0.

Connecting to a switchboard

Switchboard compatibility

This telephone may be connected to most types of switchboard, however in the event of any difficulties, consult your switchboard Service Provider.

Recall (R)

Recall is used when connected to certain switchboards/PBXs and some BT Calling Features, or those services available via your network provider. The BT4600 supports time break recall but not earth loop recall.

R&TTE

This product is intended for use within the UK for connection to the public telephone network and compatible switchboards.

This equipment complies with the essential requirements for the Radio Equipment and Telecommunications Terminal Equipment Directive (1999/5/EC).

Declaration of Conformance

Hereby, BT declares that this BT4600 is in compliance with the essential requirements and other relevant provisions of Directive 1999/5/EC.

If you would like a copy of the Declaration of Conformance, please visit bt.com/producthelp

For your records

Date of purchase:

Place of purchase:

For guarantee purposes, proof of purchase is required, so please keep your receipt.

Enter your base system PIN here:

[/ / /]

Enter your remote access PIN here:

[/ / /]

For a Better Future

We're always looking to make our products last longer and use less power, so we don't have such a big impact on the environment.

To find out about what we are doing, visit **bt.com/betterfuture**



Offices worldwide

The services described in this publication are subject to availability and may be modified from time to time. Services and equipment are provided subject to British Telecommunications plc's respective standard conditions of contract. Nothing in this publication forms any part of any contract.

© British Telecommunications plc 2017.
Registered Office: 81 Newgate Street, London EC1A 7AJ.
Registered in England No. 1800000.
Printed in China.

Designed by The Art & Design Partnership.

Available in other formats including braille, large print or audio CD. If you would like a copy, please call 0800 145 6789*.

* Calls made from within the UK mainland network are free. Mobile and international call costs may vary.

BT4600 (03/17) Issue 4

