

BUSH

Instruction manual

Q5S Soundbar



You'll soon be enjoying your new Soundbar.

It all begins here, with your instructions. Don't worry, there's nothing too technical coming up. Just simple, step-by-step guidance to get you up and running quickly. Sound good? Then let's get started.

Help and Guidance

We're here to help you get the most from your Soundbar. Should you require any guidance, a simple solution can often be found online at:

www.argos-support.co.uk

If you still require further assistance, call one of our experts on **0345 600 3021**.

Contents

1 Safety information

Safety information 6

2 Getting to know your Soundbar

Ready? Let's begin 8

Accessories 8

Control panel and remote control 9

Making the connections 11

Installing the remote battery 12

3 Using your Soundbar

Standby mode 14

Switching inputs 14

Adjusting the volume 14

LED status table 14

EQ presets 14

Bass enhancement 14

Mute function 14

Voice message feedback 15

Pairing a bluetooth device 15

Bluetooth LED status table 15

Controlling a paired device 15

Bluetooth notes 15

4 Other information

Wall mounting the soundbar 18

Technical specification 19

Care & maintenance 19

5 Product support

Troubleshooting 22

Help and assistance 23

Disposal 24

Guarantee 25

This page is left intentionally blank

Safety information

1

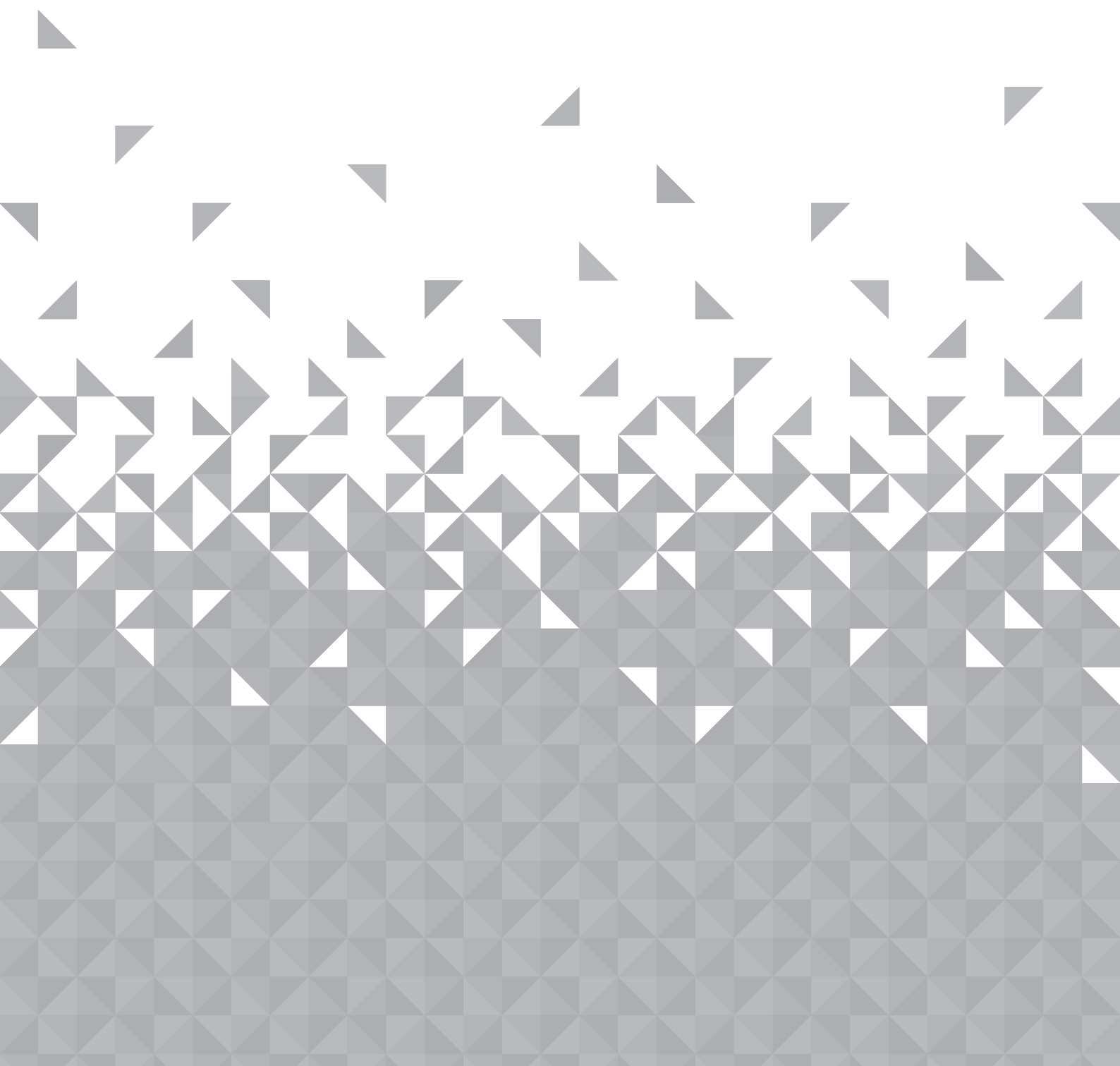



Safety information

Important - Please read these instructions fully before installing or operating

Power source



- This symbol means that this unit is double insulated. An earth connection is not required.
- The appliance must be connected to a 100-240 volt 50/60Hz AC supply by means of a three pin socket.
- Unplug this apparatus during lightning storms or when unused for long periods of time - to prevent damage to this product.



- Opening or removing covers may expose you to dangerous voltages or other hazards.



- To prevent risk of fire or electric shock, avoid overloading wall outlets, extension cords, or integral convenience receptacles.

- Use suitable power sources - Plug the product into a suitable power source, as described in the operating instructions or as marked on the product.
- The supply voltage should be the same as that indicated in the technical specifications and the appliance rating plate.
- If the socket outlets in your home are not suitable for the plug supplied with this unit check with a qualified electrician for replacement.
- In order to disconnect the apparatus from the mains completely, switch off the outlet and remove the mains plug completely.



- Do not bend, stretch or pull the supply cable in order to avoid electric shock.
- When installed, the power socket must be within easy reach.
- Do not install the unit in a confined space. Allow adequate ventilation to prevent heat build-up.
- For indoor use only.

Heat build up

- During use the unit will heat up, this is not a malfunction. If the unit is used continuously at high volume levels, the unit temperature will rise considerably. Do not touch the unit to avoid potential burns.

Colour irregularity on TV screen

Colour irregularities may be seen on certain types of TV.

- If such an irregularity is seen turn off the TV, then turn on again after 15 to 30 minutes.
- If the colour irregularity is still seen place the soundbar unit further away from the TV.

Moisture and water

- Do not use this apparatus near water or moisture.
- Do not use this product near a bathtub, washbowl, kitchen sink, and laundry tub, in a wet basement, near a swimming pool, or anywhere else that water or moisture is present.

Heat sources and flames



- Batteries shall not be exposed to excessive heat such as sun, fire or the like
- To prevent risk of fire or electric shock, avoid overloading wall outlets, extension cords, or integral convenience receptacles.

Servicing and repairs

- Refer all servicing to qualified service personnel
- Servicing is required when the apparatus has been damaged in any way: such as liquid has been spilled or objects have fallen into the apparatus; the apparatus has been exposed to rain or moisture, does not operate normally, or has been dropped.

If you require any technical guidance or find that your product is not operating as intended, a simple solution can often be found in the **Troubleshooting** section of these instructions,

Getting to know your Soundbar

2

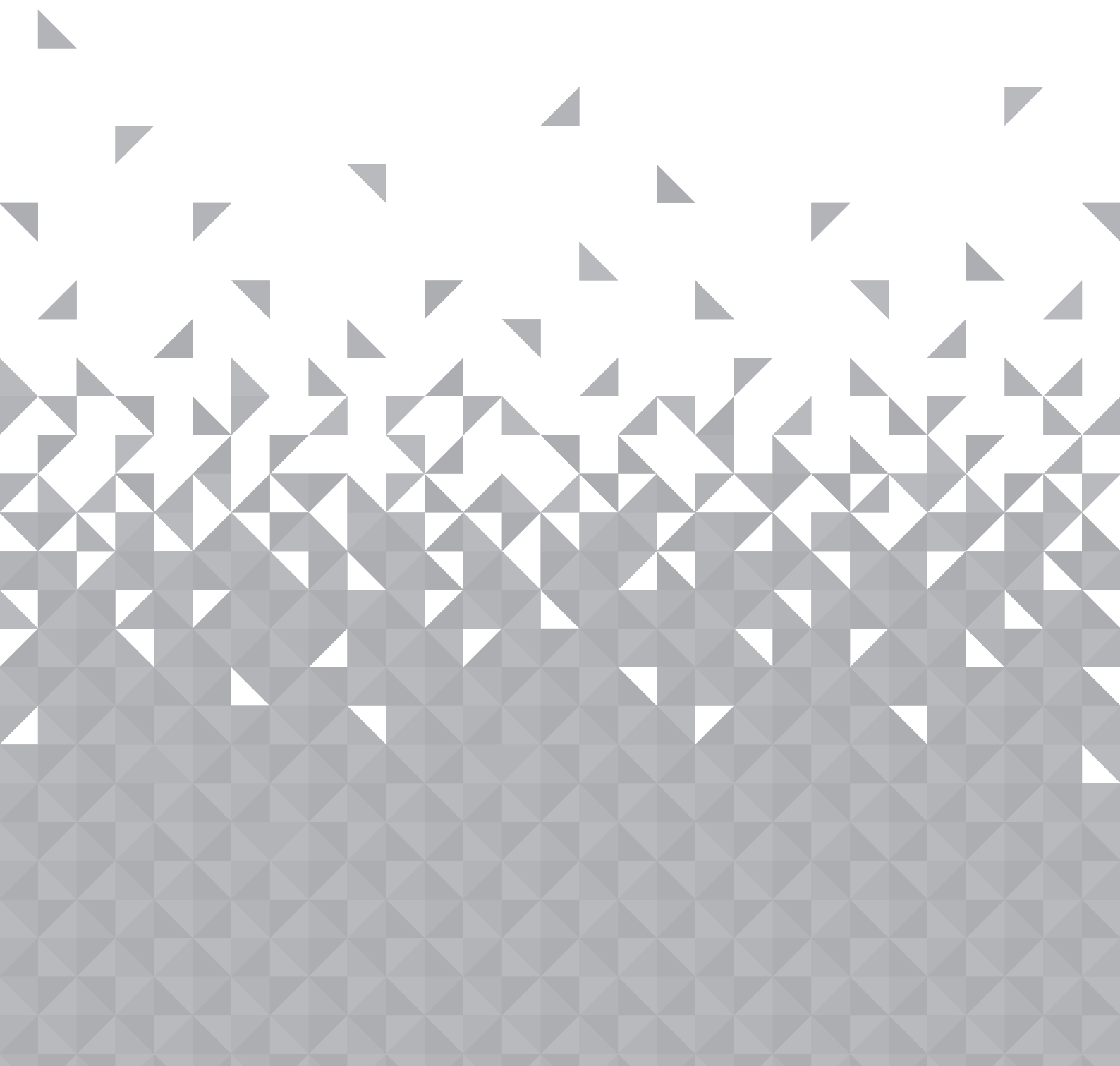

Getting to know your Soundbar

You'll be up and running in no time

Ready? Let's begin...

Please read these instructions carefully. They contain important information which will help you get the best from your Soundbar and ensure safe and correct installation and operation.

If you require any further assistance, our technical experts are happy to help. For full details, refer to the product support section at the end of these instructions.

Accessories

1. Q5S Soundbar
2. Sub woofer
3. Remote control
4. CR2032 battery
5. Digital coaxial audio cable
6. Digital optical cable
7. 3.5mm to 3.5mm audio cable
8. Mains adapter
9. Instruction manual

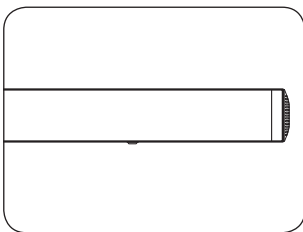

Q5S Soundbar

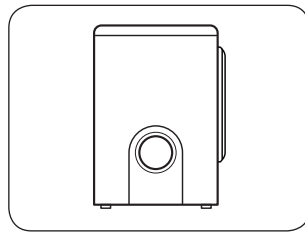

Sub woofer

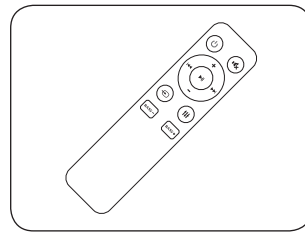

Remote control

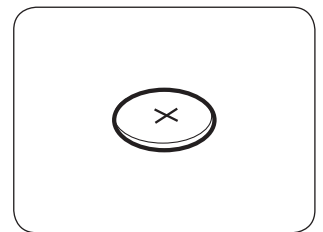

CR2032 battery

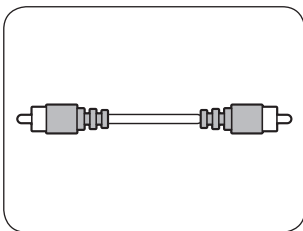

Digital coaxial cable

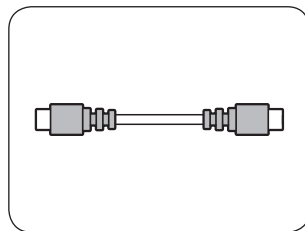

Digital Optical cable

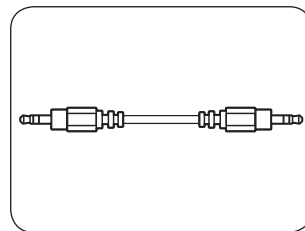

3.5mm to 3.5mm cable

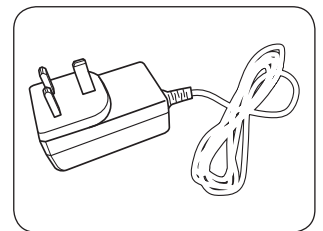

Mains adapter

If you require any technical guidance or find that your product is not operating as intended, a simple solution can often be found in the **Troubleshooting** section of these instructions.

Getting to know your Soundbar

You'll be up and running in no time

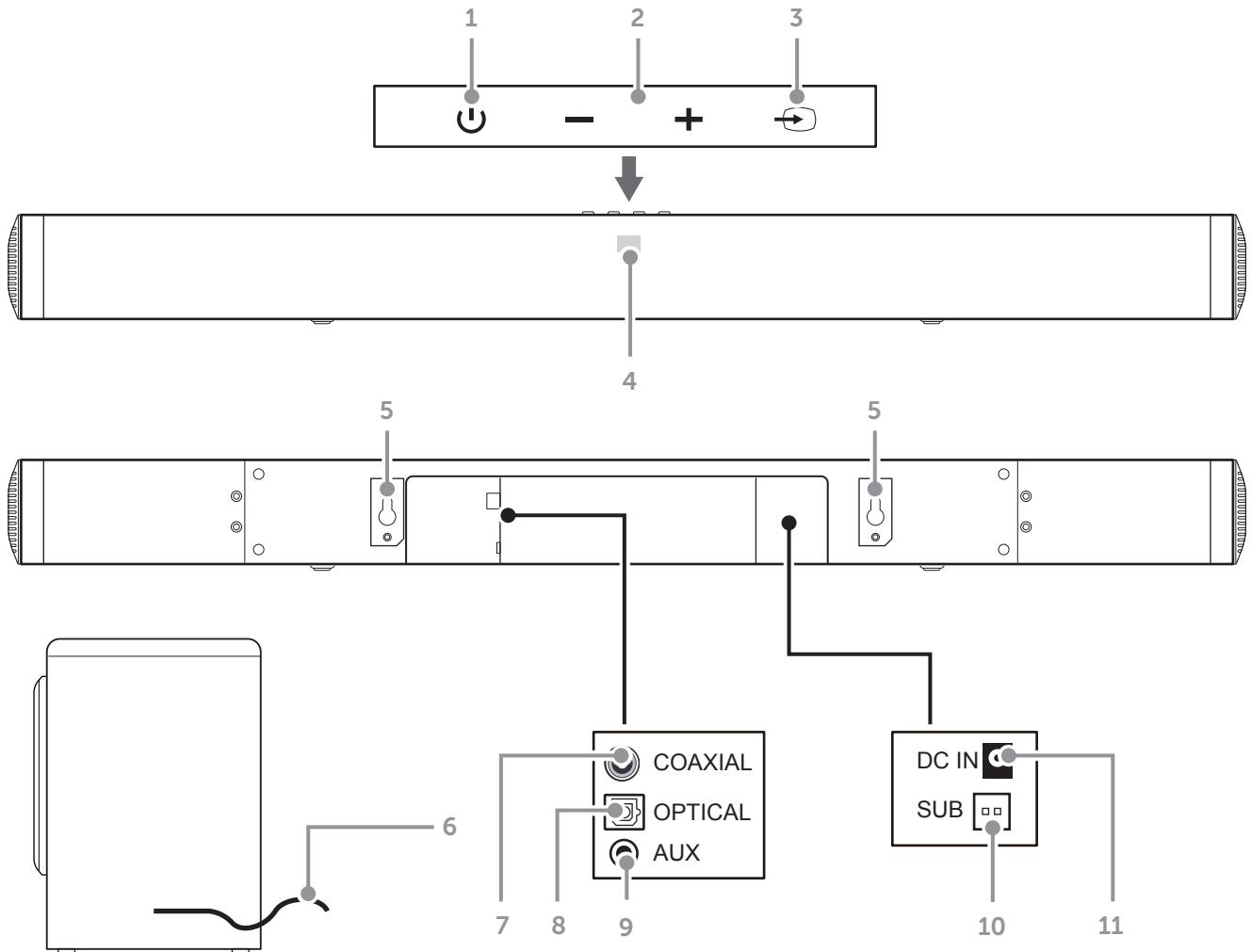

- 1. STANDBY button:** Switch on the Sound bar or switch to STANDBY mode.
- 2. VOLUME + / - buttons:** Increase or decrease the output volume.
- 3. SOURCE touch button:** Select an audio source from AUX, OPTICAL, COAX or BT inputs.
- 4. STATUS LED:** Input mode and standby status.
- 5. WALL-MOUNT BRACKETS:** Use these brackets to fix the Sound bar to a wall.
- 6. SUB WOOFER CONNECTION CABLE:** Connect to the soundbar.
- 7. COAXIAL DIGITAL AUDIO INPUT (RCA):** Connect the digital audio output from a TV, DVD or Blu-ray player.
- 8. OPTICAL DIGITAL AUDIO INPUT:** Connect the digital audio output from a TV, DVD/ Blu-ray player or games console.
- 9. AUX AUDIO INPUT (3.5mm):** Connect the analogue audio output from an MP3 player or similar using a 3.5mm audio cable.
- 10. SUB WOOFER CONNECTION SOCKET:** Connect the sub woofer cable from No 6.
- 11. MAINS POWER DC INPUT:** Connect the supplied power adapter.

or online at www.argos-support.co.uk If you still require further assistance, call one of our experts on 0345 600 3021.

Getting to know your Soundbar

You'll be up and running in no time

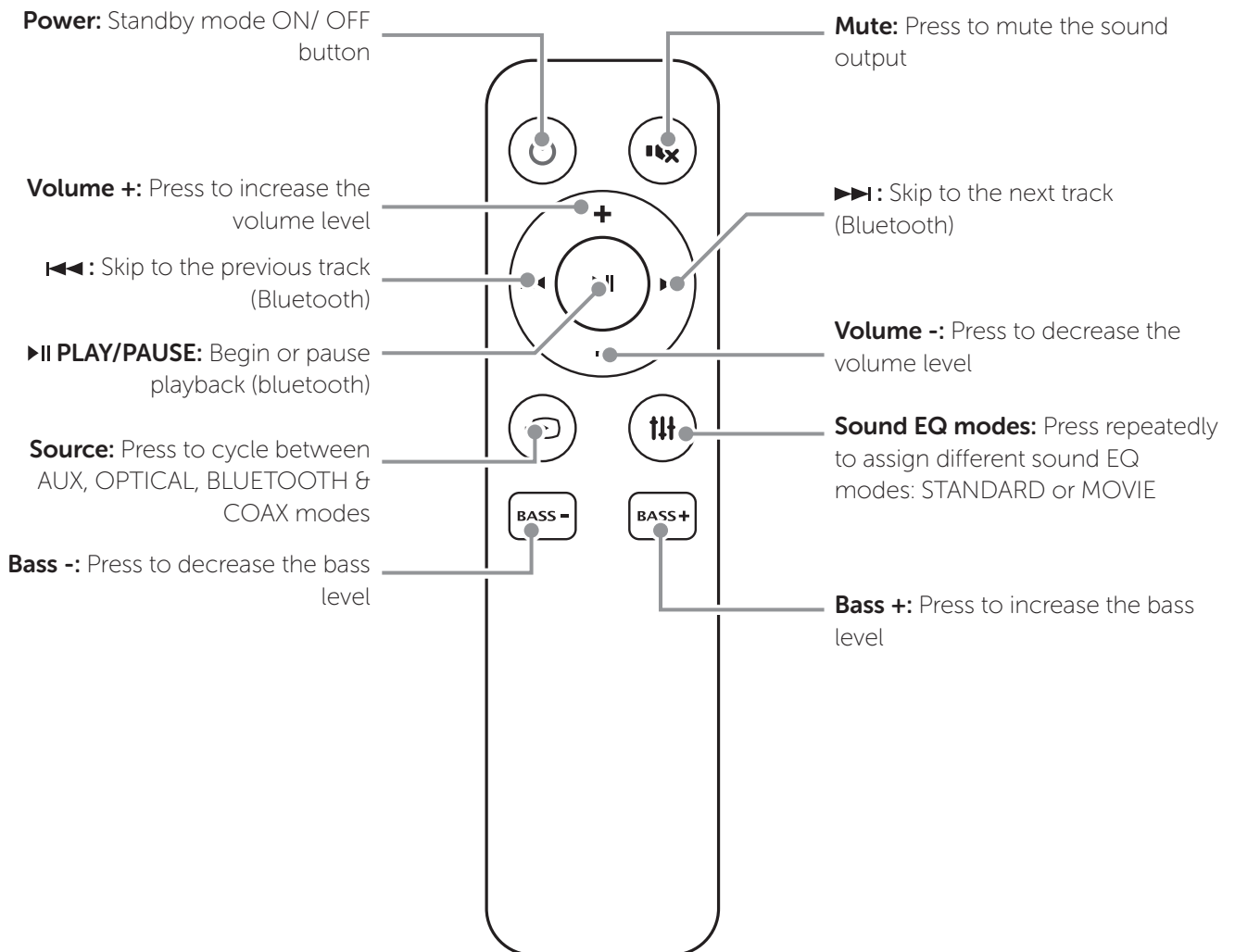

If you require any technical guidance or find that your product is not operating as intended, a simple solution can often be found in the **Troubleshooting** section of these instructions,

Getting to know your Soundbar

You'll be up and running in no time

Making the connections

Follow the below connection guide to connect the Q5S Soundbar to a TV, DVD/Bluray or games console with a digital coaxial OR optical output, a non-digital TV or external audio source such as an MP3 player or smartphone.

NOTE: DO NOT power on the mains until all other connections are made.

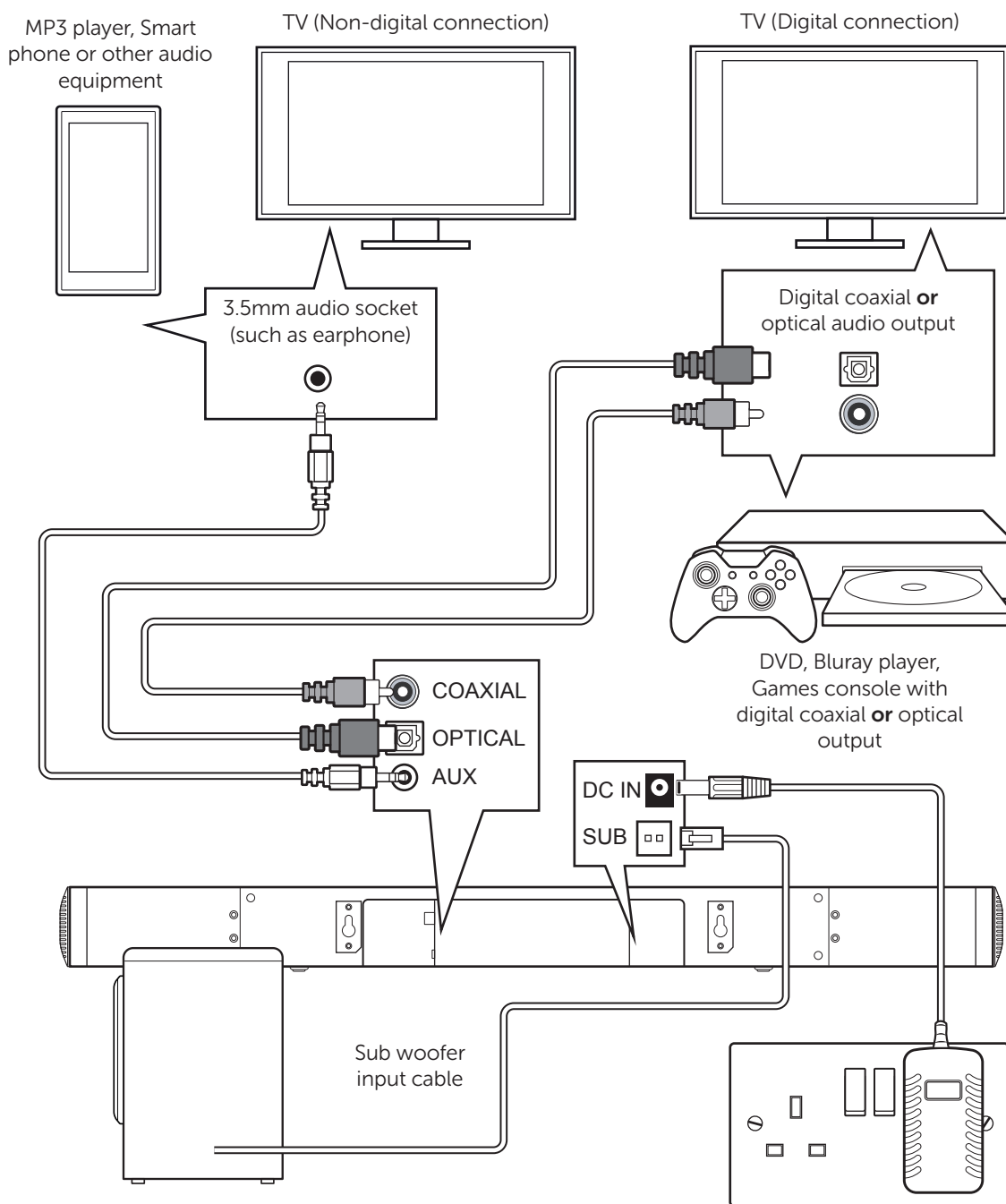

or online at www.argos-support.co.uk If you still require further assistance, call one of our experts on 0345 600 3021.

Getting to know your Soundbar

You'll be up and running in no time

Installing the remote battery

1. Turn the battery cover counter clockwise using a coin to open the battery compartment. **(Fig 1)**

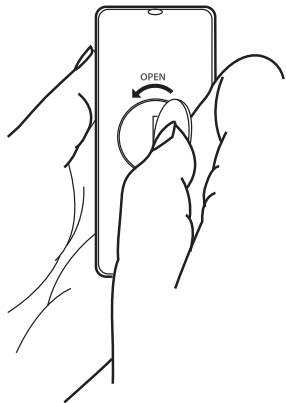

Fig 1.

2. Insert the CR2032 battery into the battery compartment with the + symbol facing upwards. **(Fig 2)**

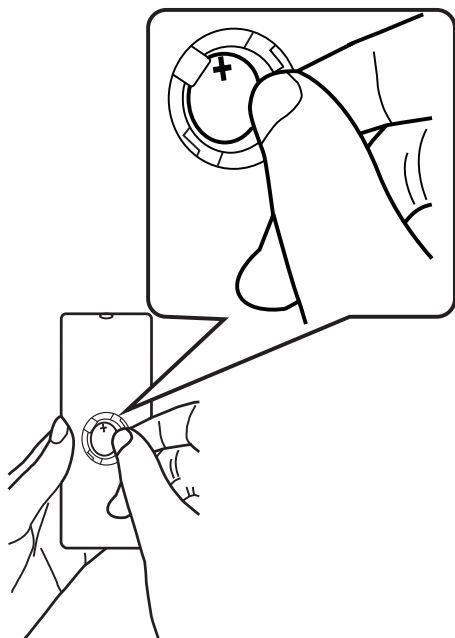

Fig 2.

3. Replace the battery compartment cover and turn clockwise using the a coin to close. **(Fig 3)**

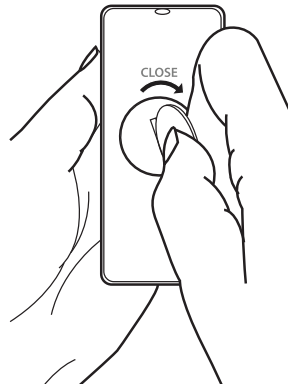

Fig 3.

Battery disposal advice

- Dispose of used batteries with regard to the recycling regulations in your area.
- Do NOT short circuit batteries or throw them into water, the general rubbish or in a fire. Weak batteries can leak and damage the remote control. Replace them in good time!
- Keep coin-sized button batteries out of sight and out of the reach of children. Coin lithium batteries can cause serious injury when swallowed.

If you require any technical guidance or find that your product is not operating as intended, a simple solution can often be found in the **Troubleshooting** section of these instructions,

Using your Soundbar

3

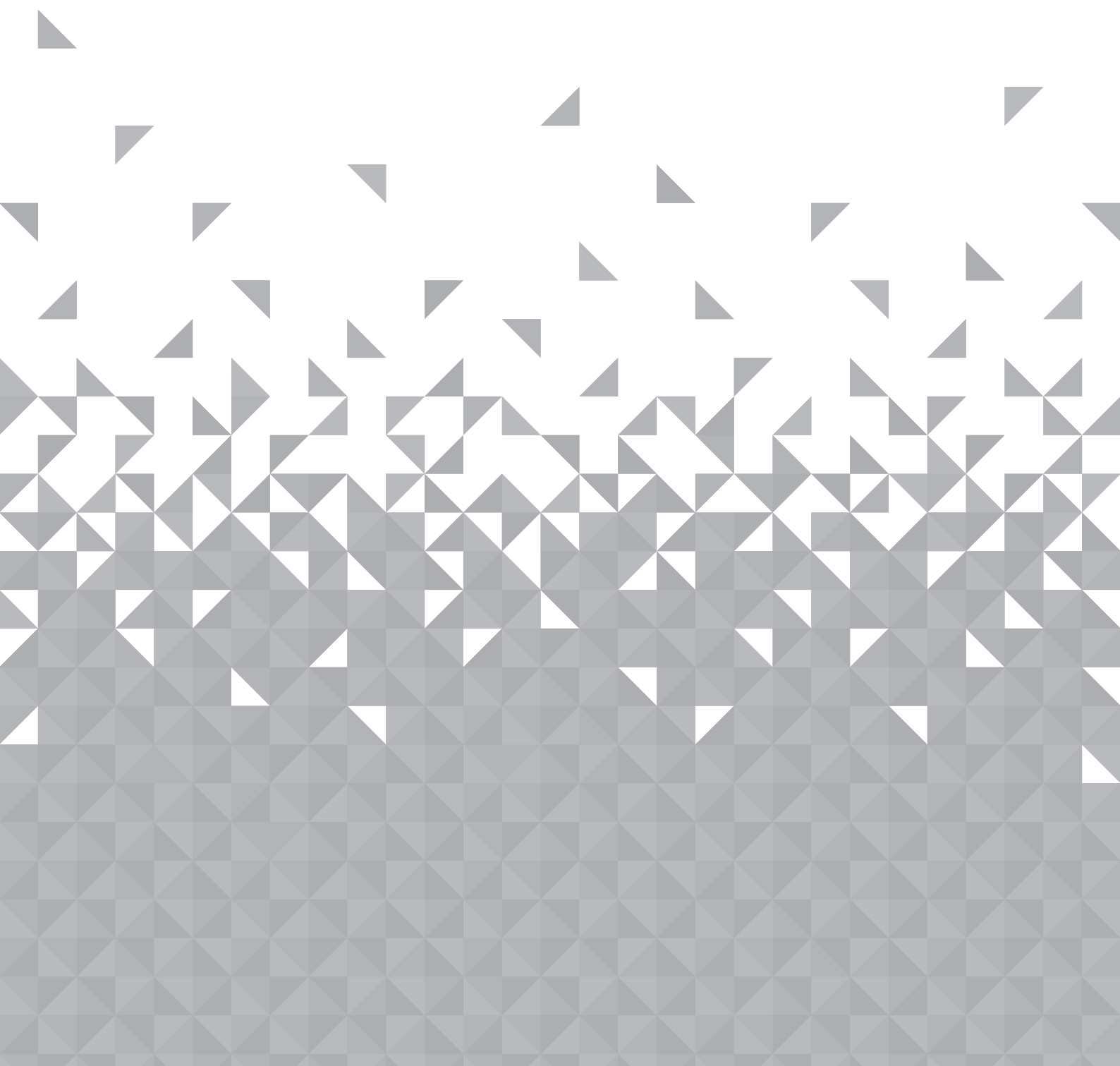

Using your Soundbar

Let's get started

Standby mode

This unit is designed to enter STANDBY mode automatically after 20 MINUTES (approximately) of inactivity. Press the STANDBY button to wake the unit.

1. Press the STANDBY button on the unit (1) or press the STANDBY button on the remote to put the system into standby mode.
2. To resume normal operation press either button again.

Switching inputs

Follow the below steps to switch inputs between : Auxiliary, Coaxial, Bluetooth or Optical.

1. Ensure the Sound bar is powered ON. If not press the STANDBY button on the unit (1) or remote.
2. Press the SOURCE button on the unit (3) or remote repeatedly until you reach the required input mode.

- Auxiliary input GREEN LED
- Coaxial input WHITE LED
- Optical input PURPLE LED
- Bluetooth input BLUE LED

When switching inputs there will be a 2 second pause after selecting BT while the unit scans for paired devices.

Adjusting the volume

1. To increase the volume level press the VOLUME+ button on the main unit (2) or remote repeatedly or press and hold for fast adjustment. The status LED will blink accordingly.
2. To decrease the volume level press the VOLUME- button on the main unit (2) or remote repeatedly or press and hold for fast adjustment. The status LED will blink accordingly.

LED status table

The below table explains the LED indications.

Operation	Description	Action
Standby	Standby	RED (Solid)
Source	Aux	GREEN (Solid)
	Coaxial	WHITE (Solid)
	Optical	PURPLE (Solid)
	Bluetooth paired	BLUE (Solid)
	Bluetooth ready for pairing	BLUE (Flash)
Vol +/-	Adjust volume	Current input colour (blink once)
Bass +/-	Adjust bass level	Current input colour (blink once)
Sound EQ	Assign EQ mode	Current input colour (blink once)
Mute	Mute sound	RED (Flash)

EQ presets

1. Press the SOUND EQ button on the remote control repeatedly to cycle through the EQ sound modes. The status LED will blink accordingly. Choose between :- STANDARD (STD) or MOVIE.

Bass enhancement

1. To increase the bass press the BASS + button on the remote. The status LED will blink accordingly.
2. To decrease the bass press the BASS - button on the remote. The status LED will blink accordingly.

The BASS levels range from -3 to +3.

Mute function

1. Pressing the MUTE button on the remote will temporarily silence the audio output. The status LED will blink accordingly.
2. Press the MUTE button again to resume the audio output. The status LED will blink accordingly.

Using your Soundbar

Let's get started

Voice message feedback

Follow the below steps to enable the voice message when performing tasks.

1. Enter STANDBY mode if not already.
2. Press and hold the ►|| PLAY/PAUSE button on the remote for 5 seconds.
3. Repeat the same process to disable the voice message when enabled.

Pairing a bluetooth device

Before you can use the sound bar with your phone or other bluetooth capable device you will need to pair the device to the sound bar.

1. Press the SOURCE button on the main unit (3) or remote repeatedly until you see the blue LED.
2. When selected the status LED will flash while the unit tries to connect to previously paired devices. If no devices are found the status LED will remain flashing to indicate it is ready for pairing a new device.
3. Enable the Bluetooth function on your audio device and search for a device labelled 'BUSH Q5S' in the available list.
4. Select and enable pairing for the 'BUSH Q5S' device. If prompted for a password enter '0000'.
5. If pairing is successful the sound bar will beep and the STATUS LED will stop flashing.
6. If the connected device goes out of range, the sound bar will attempt to connect for 2 minutes. When the device comes into range the sound bar will reconnect again automatically.
7. To remove a paired device using only the sound bar, press and hold the PLAY/PAUSE button on the remote control for 5 seconds. The STATUS LED will begin flashing once more.

Bluetooth LED status table

Status LED	Reason
Solid blue (No flash)	Connected
Blue flashing	Auto reconnecting with the last paired device.
	Pairing mode.

Controlling a paired device

Once connected you can either use the controls on the audio device to begin playback, skip tracks etc. Or you can use the control buttons on the sound bar & remote.

1. The ►|| PLAY/PAUSE button on the remote when pressed will begin playback of the selected track on the audio device. Press again to pause playback.
2. To skip to the next track press the SKIP ►► button on the remote.
3. To skip to the previous track press the SKIP ◀◀ button on the remote.
4. Any further operations must be done from the audio device.

The volume output is effected by the volume level on the audio source EG: Phone or laptop, so make sure that is set to about 70-80% (not too loud to avoid distortion).

Bluetooth notes

- The operation range of bluetooth is approximately 10 meters (30 Feet). Any obstacles in the path between devices may reduce this range.
- Only one Bluetooth device can be paired at a time.
- Not all Bluetooth devices are compatible.

This page is left intentionally blank

Other information 4

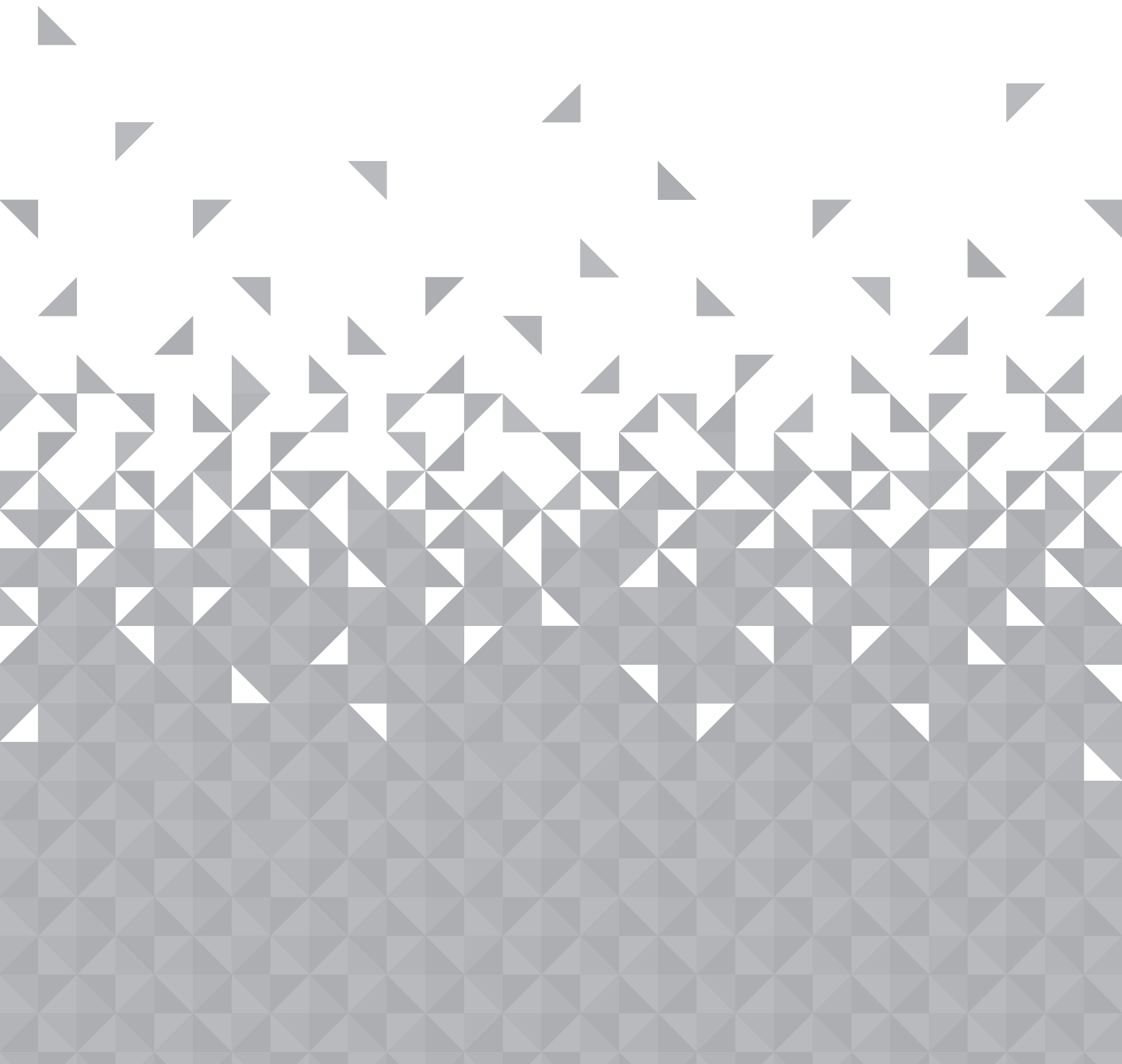

Other information

Helpful technical information

Wall mounting the soundbar

1. Align the Soundbar in the chosen location. Use a pencil to mark the drilling positions 287mm (11.3") apart. (Fig 4)

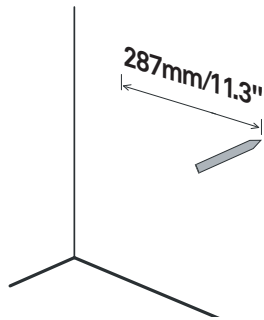
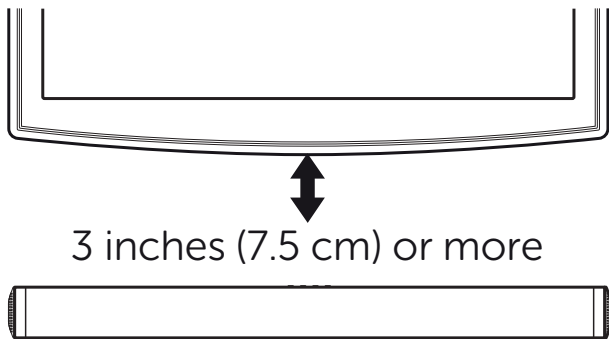

Fig 4.

The Soundbar should be located at least 75mm (3") below the bottom of the TV.



2. Drill holes as marked in STEP 1. (Fig 5)

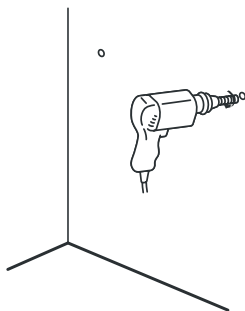

Fig 5.

3. Insert 2 screws (not supplied) into the holes and tighten. Take care to leave 5mm between the screw heads and the wall. (Fig 6)



Fig 6.

You will need to ensure the screws are long enough to sufficiently grip the wall while allowing 5mm between screw head & wall.

4. Hook the Soundbar into the screws. For secure mounting ensure the screw heads slide firmly into the narrow part of the brackets. (Fig 7)

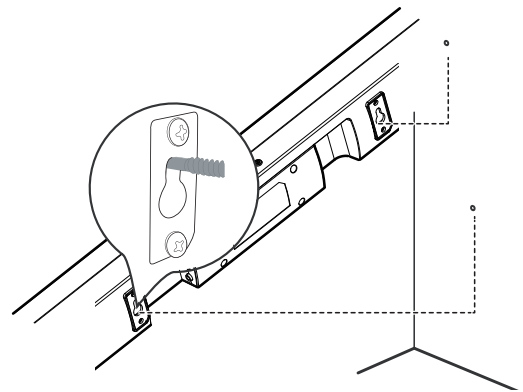

Fig 7.

- In order to avoid damage to the unit and personal injury you should get a qualified person to drill the fixing surface and fit the appropriate wall fixings.
- Take care not to allow the main unit to fall while attempting to hook onto the wall mount brackets.
- Before mounting, check the wall strength, if it is not clear then consult relevant qualified personnel.
- When drilling into walls, always check that there are no hidden wires or pipes etc.
- Make sure the screws & wall plugs are suitable for supporting the unit.

If you require any technical guidance or find that your product is not operating as intended, a simple solution can often be found in the **Troubleshooting** section of these instructions,

Other information

Helpful technical information

1. Technical specification

Amplifier	
Power output	100W MAX
Frequency response	20Hz - 20KHz \pm 3dB
Input sensitivity	550 mV
Main unit	
Power supply	INPUT: 100-240V ~ 50-60Hz OUTPUT: 24V $\overline{\text{---}}$ 1.5A
Power consumption	25W
Standby power consumption	\leq 0.5W
Full range speaker drivers	Impedance: 4 Ohm, 52mm (2") Frequency response: 250Hz ~ 20KHz
Subwoofer	Impedance: 8 Ohm, 116mm (5.25") Frequency response: 35~200Hz
Dimensions	Soundbar: 730 x 60 x 62mm Sub woofer: 178 x 221 x 296mm
Mains cable length	1.5M
Remote control	
Battery	1 x CR2032
Bluetooth	
Bluetooth compatibility	EDR, A2DP, AVRCP
Bluetooth version	2.1

Care & maintenance

After using the Soundbar

Set to Standby.

Switch the unit off at the mains and unplug it if you are leaving it unattended for a long period (holidays etc).

Avoid leaving the battery fitted in the remote control if you leave the unit unattended for long periods. It may leak and damage the remote control.

Care & cleaning

All care and cleaning operations should be carried out with the unit unplugged from the mains power.

Occasionally wipe the cabinet with a lint free duster.
Never clean the unit with liquids or solvents.

This page is left intentionally blank

Product support 5

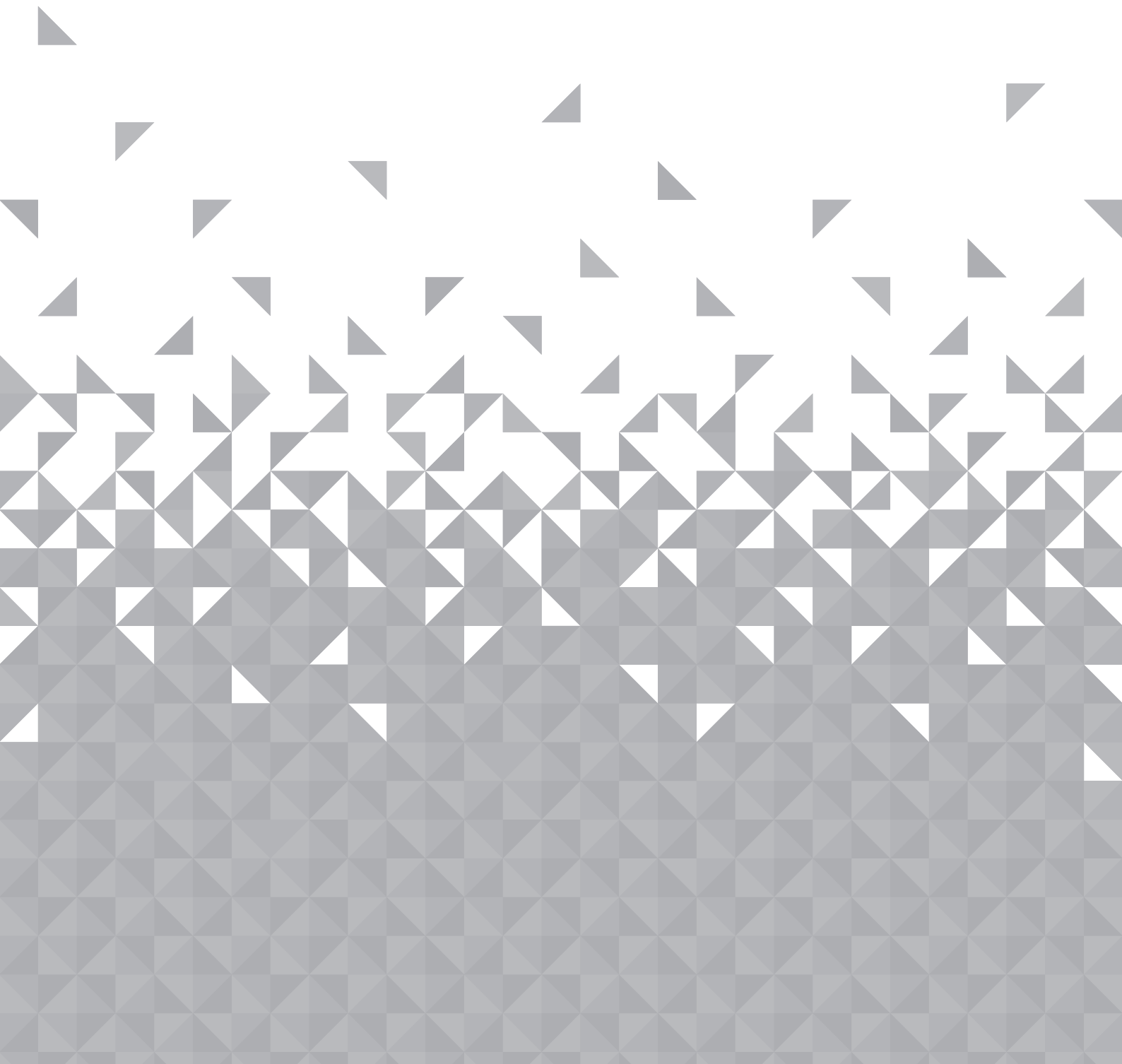

Product support

Help is always at hand

Troubleshooting

No power.

- Ensure the mains plug is connected to a power supply, and is switched ON.
- Make sure there is power to the mains socket.

No sound?

- Make sure if playing from the AUX input, the external source has the volume turned up and is playing a track.
- Make sure the volume is turned up.
- If using the digital coaxial or optical connection ensure the source DIGITAL output is set to PCM, LPCM, PCM 2Ch stereo or PCM downmix.
- Bluetooth device not paired. Check 'Pairing a bluetooth device'.

No response from the Q5S Soundbar.

- Unplug the power cable for 1 minute then plug back in again.

Remote control does not work.

- Reduce the distance between the remote and main unit
- Check the batteries are installed correctly.
- Replace the batteries
- Aim the remote directly at the Sound bar

Unit powers off after 20 minutes.

- This unit is designed to enter STANDBY mode automatically after 20 MINUTES of inactivity. Press the STANDBY button to wake the unit.

Product support

Help is always at hand

Help and assistance

If you require any technical guidance or find that your Q5S Soundbar is not operating as intended, a simple solution can often be found in the **Troubleshooting** section of these instructions or online at www.argos-support.co.uk

If you still require further assistance, call one of our experts on **0345 600 3021 ***. To help give us give you a fast and efficient service please have the following information ready:

Model Ref.	<input type="text"/>	You can find these on the rating plate - a small information panel (usually a sticker or metal plate) on the rear of your product
Serial number	<input type="text"/>	
Date of purchase	<input type="text"/>	This will be shown on your receipt

Local call rates applies*

Lines open 8am-7pm Monday to Saturday and 10am-4pm Sunday.

*Calls to Argos enquiry lines may attract a charge and set up fee from residential lines depending on your call plan/tariff. Mobile and other providers costs may vary, see www.bt.com/pricing for details.

For Security and training purposes, telephone calls to and from customer service centres maybe recorded and monitored. Calls from Republic of Ireland will attract international call charges.

or online at www.argos-support.co.uk If you still require further assistance, call one of our experts on **0345 600 3021**.

Product support

Help is always at hand

Disposal



- Disposal of your old product. Your product is designed and manufactured with high quality materials and components, which can be recycled and reused
- When this crossed out wheeled bin symbol is attached to a product it means the product is covered by the European Directive 2002/96/EC.
- Please make yourself aware of the local collection system for electrical and electronic products.
- Please act according to your local rules and do not dispose of your old products with your normal household waste.
- The correct disposal of your old product will help prevent potential negative consequences for the environment and human health.

Bluetooth™

The Bluetooth® word mark and logos are registered trademarks owned by Bluetooth SIG, Inc. and any use of such marks is under license.

 This product is intended for use within the UK. This equipment complies with the essential requirements for the Radio Equipment and Telecommunications Terminal Equipment Directive RED 2014/53/EU.

Declaration of Conformance

Hereby, Argos Ltd, declares that this Band II LPD device is in compliance with the essential requirements and other relevant provisions of Directive 1999/5/EC. The complete declaration of conformity can be obtained by contacting <http://www.argos-support.co.uk/>

If you require any technical guidance or find that your product is not operating as intended, a simple solution can often be found in the **Troubleshooting** section of these instructions,

Product support

Help is always at hand



Call us now and activate your 12 month guarantee

Thank you for choosing Bush. Your new product is guaranteed against faults and breakdowns for 12 months. Don't forget to register it with us today so we can provide you with our best possible after-sales service and useful updates.

www.bushregistration.co.uk

FREEPHONE*

0800 597 8548

Lines are open 8am - 8pm, 365 days a year. *Calls may be recorded and monitored.

Your Bush Guarantee

This product is guaranteed for twelve months from the date of original purchase. Any defect that arises due to faulty materials or workmanship will be repaired free of charge (or if applicable the product will be replaced or the purchase price refunded) where possible during this period by the dealer from who your purchased the unit.

The guarantee is subject to the following provisions:

- The guarantee does not cover accidental damage, misuse, cabinet parts, knobs or consumable items.
- The product must be correctly installed and operated in accordance with the instructions contained in the manual.
- It must be used solely for domestic purposes. The guarantee will be rendered invalid if the product is re-sold or has been damaged by inexpert repair.
- Specifications are subject to change without notice.
- Bush disclaim any liability for loss or damage arising from the breakdown of the product.
- This guarantee is in addition to and does not diminish your statutory or legal rights.

Important Data Protection Information

If you provide us with information about another person, you confirm that they have appointed you to act for them, to consent to the processing of their personal data including sensitive personal data and that you have informed them of our identity and the purposes (as set out in the Important Data Privacy notice displayed overleaf) for which their personal data will be processed.

You are entitled to ask for a copy of the information we hold about you (for which we may charge a small fee) and to have any inaccuracies in your information corrected.

For quality control and training purposes, we may monitor or record your communications with us.

If your personal details change, if you change your mind about any of your marketing preferences or if you have any queries about how we use your information, please let us know by contacting our Data Protection Officer, Domestic & General, Leicester House 17 Leicester Street, Bedworth, Warwickshire CV12 8JP.

Guarantor: Argos Limited - 489 - 499 Avebury Blvd. - Milton Keynes - MK9 2NW

or online at www.argos-support.co.uk If you still require further assistance, call one of our experts on **0345 600 3021**.

BUSH

Contact:

www.argos-support.co.uk

Helpline: 0345 600 3021

