

# BUSH

## Instruction manual

V7SDW  
V7SDS  
V7SDB



You'll soon be enjoying your new <tumble dryer>.

It all begins here, with your instructions. Don't worry, there's nothing too technical coming up. Just simple, step-by-step guidance to get you up and running quickly. Sound good? Then let's get started.

## Help and Guidance

We're here to help you get the most from your <tumble dryer>. Should you require any guidance, a simple solution can often be found online at:

**[www.argos-support.co.uk](http://www.argos-support.co.uk)**

If you still require further assistance, call one of our experts on **0345 257 7271**.

# Contents

## 1 Safety information

Safety information 6

## 2 Getting to know your <tumble dryer >

Ready? Let's begin 10

Accessories 12

## 3 Installing your <tumble dryer >

Installation requirements 14

Connections 15

Electrical connection 16

## 4 Functions

Functions 18

## 5 Using your <tumble dryer >

Using your <tumble dryer> 22

## 6 Care and Maintenance

Cleaning 26

Technical specifications 27

Product fiche 28

## 7 Product support

Troubleshooting 30

Help and assistance 31

Declaration of conformance to product standards 32

Disposal 33



# Safety information

1





## Safety information

**Important** - Please read these instructions fully before installing or operating

### Before use

- The installation of this appliance is best carried out by 2 people.
- Dispose of all packing carefully and responsibly.
- The appliance is designed for **indoor use only** and must be protected from rain, moisture and extreme temperature variations.
- This appliance is designed for household use. **Do not** use the appliance for industrial and commercial use, or any other purpose.
- The appliance **MUST** be positioned on a firm level base.
- **Do not** splash water on the appliance. It may cause electrical parts to fail and result in an electric shock.
- For appliance with ventilation openings in the base, the carpet **must not** obstruct the openings.
- The appliance **must not** be installed behind a lockable door, a sliding door or a door with a hinge on the opposite side to that of the tumble dryer, in such a way that a full opening of the tumble dryer door is restricted.
- **Do not** sit, stand or place any other heavy objects on top of the appliance. This could result in injury or damage to the appliance.
- **Do not** allow children to play with the appliance to avoid the risk of entrapment and suffocation.
- Keep ventilation opening, in the appliance enclosure or in the built-in structure, clear of obstruction.

- The lint trap has to be cleaned frequently, if applicable.
- Clean lint screen before or after each load.
- Never use the dryer without the lint filter.

### During use

- This appliance can be used by children aged from 8 years and above and persons with reduced physical, sensory or mental capabilities or lack of experience and knowledge if they have been given supervision or instruction concerning use of the appliance in a safe way and understand the hazards involved. Children shall not play with the appliance. Cleaning and user maintenance shall not be made by children without supervision.
- The tumble dryer is not to be used if industrial chemicals have been used for cleaning.
- Lint must not to be allowed accumulate around the tumble dryer.
- Do not dry unwashed items in the tumble dryer.
- Items that have been soiled with substances such as cooking oil, acetone, alcohol, petrol, kerosene, spot removers, turpentine, waxes and wax removers should be washed in hot water with an extra amount of detergent before being dried in the tumble dryer.
- Items such as foam rubber (latex foam), shower caps, waterproof textiles, rubber backed articles and clothes or pillows fitted with foam rubber pads should not be dried in the tumble dryer.

If you require any technical guidance or find that your product is not operating as intended, a simple solution can often be found in the **Troubleshooting** section of these instructions.



## Safety information

**Important** - Please read these instructions fully before installing or operating

- Fabrics softeners, or similar products, should be used as specified by the fabric softener instructions.
- The final part of a tumble dryer cycle occurs without heat (cool down cycle) to ensure that the items are left at a temperature that ensure that the items will not be damaged.
- Remove all objects from pockets such as lighters and matches.
- **WARNING:** Never stop a tumble dryer before the end of drying cycle unless all items are quickly removed and spread out so that the heat is dissipated.
- Children of less than 3 years should be kept away unless continuously supervised.
- Do not attempt to repair the appliance yourself.  
Contact the Customer Helpline:  
0345 257 7271.
- If the supply cord is damaged, it must be replaced by the manufacturer, its service agent or similarly qualified persons in order to avoid a hazard.
- Oil-affected items can ignite spontaneously, especially when exposed to heat sources such as in a tumble dryer. The items become warm, causing an oxidation reaction in the oil. Oxidation creates heat. If the heat cannot escape, the items can become hot enough to catch fire. Piling, stacking or storing oil-affected items can prevent heat from escaping and so create a fire hazard.
- If it is unavoidable that fabrics that contain vegetable or cooking oil or have been contaminated by hair care products be placed in a tumble dryer they should first be washed in hot water with extra detergent - this will reduce, but not eliminate, the hazard.



CAUTION: HOT SURFACE!



CAUTION: RISK OF FIRE!





Getting to know your  
<tumble dryer>

2



# Getting to know your <tumble dryer>

You'll be up and running in no time

## Ready? Let's begin...

Please read these instructions carefully. They contain important information which will help you get the best from your <tumble dryer> and ensure safe and correct installation and operation.

If you require any further assistance, our technical experts are happy to help. For full details, refer to the product support section at the end of these instructions.

If you require any technical guidance or find that your product is not operating as intended, a simple solution can often be found in the **Troubleshooting** section of these instructions.

# Getting to know your <tumble dryer>

You'll be up and running in no time

## Component

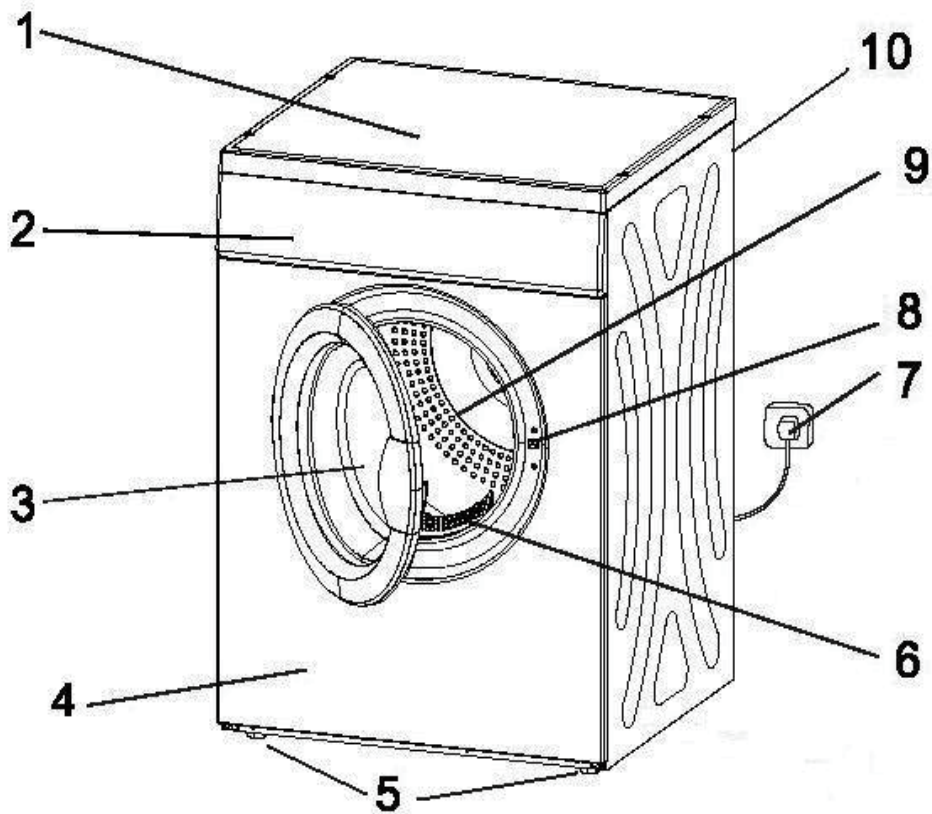

1.Top board

2.Control panel

3.Door

4.Front case

5.Adjustable feet

6. Lint filter

7. Plug

8. Door sensor

9. Tumble drum

10. Overheat Safety rest switch (back)

# Getting to know your <tumble dryer>

You'll be up and running in no time

Model	capacity	Energy class	Color
V7SDW	7kg	C	White
V7SDS	7kg	C	Silver
V7SDB	7kg	C	Black

## Accessories

- Instructions X 1
- Hose (2.5M) X 1

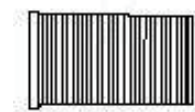

## Tools

You may use this tools to help install above parts

- glove
- spanner

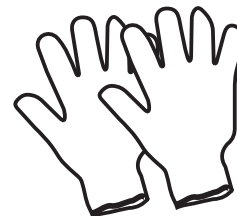
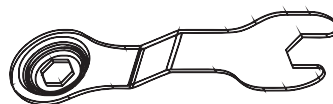

If you require any technical guidance or find that your product is not operating as intended, a simple solution can often be found in the **Troubleshooting** section of these instructions.

# Installing your <tumble dryer> 3



# Installing your <tumble dryer>

Bringing it all together

## Installation requirements

### Transportation

-  Caution: 2 people are required to unpack and handle the appliance, it is recommended that gloves are worn.
- The appliance should be transported only in an upright position. Do not tilt the appliance greater than 45°. The packaging as supplied must be intact during transportation.
- Do not move the appliance by pulling the door or handle as it may damage your flooring and wall coverings etc.
- Ensure the supply cable is not caught under the appliance during and after moving.
- Carefully remove all package materials including the foam base, dispose of correctly.

### Unpacking Tumble dryer

Caution: 2 people are required to unpack the tumble dryer, it is recommended that gloves are worn.

Carefully remove all packaging materials including the foam base, dispose of correctly.

### Installation

- Ensure sufficient spacing is provided for the appliance to be installed. Leave space on back (10cm) to ensure proper ventilation.
- Install the tumble dryer in a well ventilated room.
- Make sure that your machine is not placed on the power cord.
- Do not place the appliance near a heat source or in direct sunlight.
- Do not put any heavy objects on top of the appliance. It will damage the appliance.
- Do not install the appliance in moist and wet place.
- Adjust the feet at front to level the appliance. It should be installed on a smooth surface to avoid excessive vibration and noise.
- Never unscrew the adjustable feet from their housings.
- Refer to section "User instructions" to prepare your appliance for use.

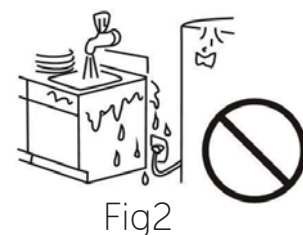
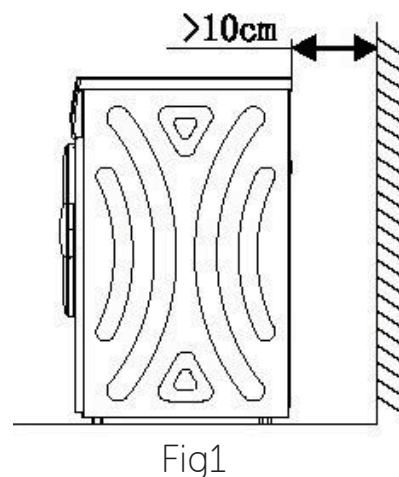

If you require any technical guidance or find that your product is not operating as intended, a simple solution can often be found in the **Troubleshooting** section of these instructions.

# Installing your <tumble dryer>

Bringing it all together

## Levelling feet

**1:**For your machine to work efficiently with minimum vibration it should be settled on flat, nonslippery,firm ground.

**2:**You can adjust the balance of your machine by changing the positioning of its feet.

**3:**First,loosen the plastic adjustment nut.(Fig 3)

**4:**Adjust by rotating the feet upwards or downwards.(Fig 4)

**5:**After the desired position has been reached, tighten the plastic adjustment nut again by rotating it upwards.

Note:Never put cartons,wooden blocks or similar materials under the machine to balance irregularities in the level of the ground.

## Connections

Hose connection

 **Warning:**2 people may be required to install the hose. It is recommended to wear the gloves

**NOTE:** Ventilation hose assures exhausting of the air from the inside of the tumble dryer.

- Carefully remove all packing materials including from the foam, dispose of correctly.
- Before installation, ensure that the unit is power off and unplug from the mains.
  - 1.Connect hose to the air outlet of the machine by screwing it tight in a clockwise direction.
  - 2.Extended the hose to the suitable length.
  - 3.Route the hose to the outdoors via a window or it can be connected to an outlet in the wall (see the diagrams).
- The air outlet hose must be extended directly to the outdoors. Keep bends to a minimum to ensure adequate ventilation.
- To prevent water accumulation in the hose, make sure the hose is not folded on the floor.
- In winter, the room temperature may be cold. The water may condense inside the hose. Periodical check is required to avoid hose damaged by the water.

 **Warning:** Do not connect the hose to the chimney of a stove or fireplace.

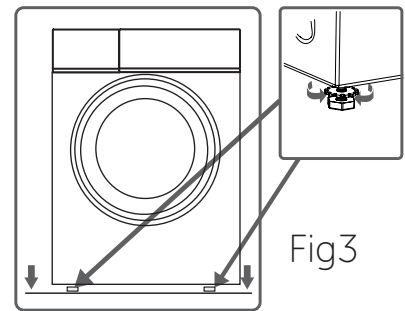

Fig3

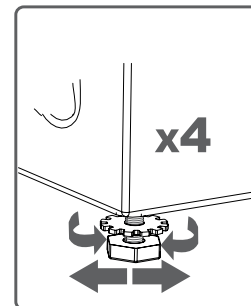

Fig4

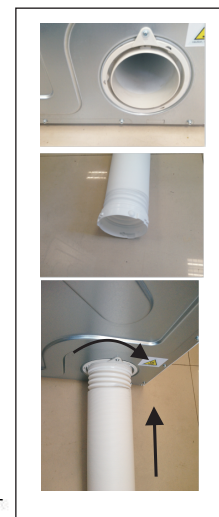

Fig5

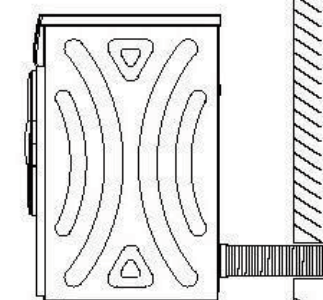

Fig6

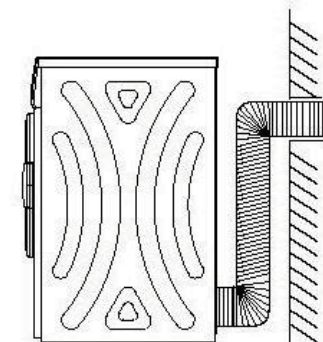

Fig7

# Installing your <tumble dryer>

## Bringing it all together

### Electrical connection



Any electrical work that is required to install this appliance **MUST** be carried out by a qualified electrician.



Warning: THIS APPLIANCE MUST BE EARTHED

Before making any electrical connections, ensure that:

- Electrical safety is only guaranteed when the earth system of your house in accordance with the related local regulations.
- Do not bend, stretch or pull the supply cable to avoid electric shock.
- Ensure the power socket is suitable for the Maximum power of the machine (fuses in the power circuit must be 13 amp).
- The supply voltage should be the same as that indicated in the technical specifications and the appliance rating plate.
- The appliance should be earthed and in compliance with the applicable law.
- When installed, the power socket must be within easy reach.
- If the socket outlets in your home are not suitable for the plug supplied with this unit check with a qualified electrician for replacement.
- To avoid the risk of overloading your plug socket, the use of adapters, multiple connectors or extension cables are not recommended. The appliance must be connected to a 220-240 volt 50Hz AC supply by means of a three pin socket, suitably earthed and protected by a 13 amp fuse.
- Should the fuse need to be replaced, a 13 amp fuse approved to BS1362/A must be used. The plug contains a removable fuse cover that must be refitted when the fuse is replaced. If the fuse cover is lost or damaged, the plug must not be used until a replacement cover has been fitted or the plug is replaced.
- A damaged plug should be cut off as close to the plug body as possible, the fuse should be removed and the plug disposed of safely.

### Plug replacement (UK & Ireland only)

Should you need to replace the plug; the wires in the power cable are coloured in the following way:

Blue - Neutral ' N '

Brown - Live ' L '

Green & Yellow - Earth ' E '

As the colours of the wires in the power cable may not correspond with the coloured markings identifying the terminals in your plug, and proceed as follows (Fig 8):

The green & yellow wire must be connected to the terminal in the plug that is marked with the letter E or by the earth symbol.

The blue wire must be connected to the terminal that is marked with the letter N.

The brown wire must be connected to the terminal that is marked with the letter L.

If power supply cord is damaged, it must be replaced by the manufacturer or its service agent or a similar qualified person in order to avoid a hazard.

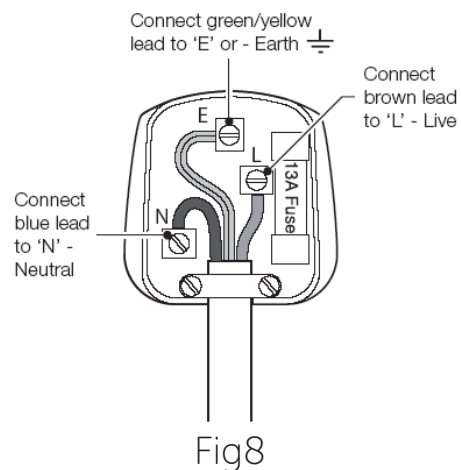

If you require any technical guidance or find that your product is not operating as intended, a simple solution can often be found in the **Troubleshooting** section of these instructions.



# Functions 4



# Functions

## Simple everyday use

### Control panel

On/Off button

- To turn on the machine press once.
- To turn off the machine press once again.

Start / pause button

- To start the set program, press once.
- To pause the running program, press once.
- To continue the program, press once again.

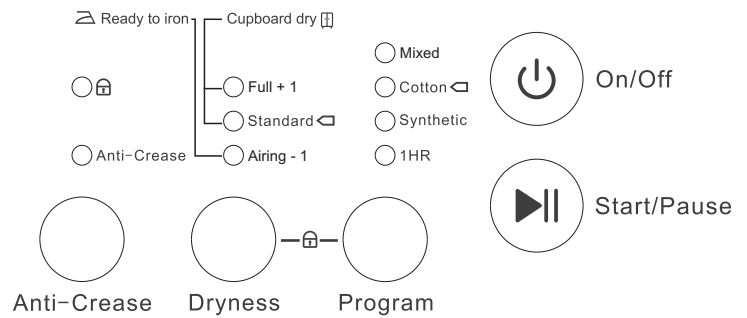

Program

- Continue to press the program button to select the desire drying program (Mixed/Cotton/Synthetic /1HR). The indicator next to the selected program will be illuminated.

Dryness

- Continue to press the dryness button to select the dire dryness setting (Full+1/Standard/Airing-1). The indicator next to the selected program will be illuminated.

Anti-crease

- To turn on the anti-crease, press the button once. The anti-crease indicator will be illuminated. To turn it off, press the button once again. The anti-crease will be off and the indicator will go off. The Anti-Crease function provides approximately 120 minutes of intermittent tumbling in unheated air at the end of the cycle to reduce wrinkling. Dried laundry is prevented from wrinkled by periodic drum one way running after the completion of the drying course.

Child safety lock(  )

- This is to avoid the operation being interrupted by a child.
- Lock : press both dryness and program knobs for 3 seconds, the child safety lock indicator will be illuminated denoting entering the child-lock state.
- Unlock : press both dryness and program knobs for 3 seconds, the child safety lock indicator will go off denoting that the lock is released.

### Operating steps for the machine



**Caution :** Before using the machine, you should study the program chart to select the desired program setting for your clothes.

1. Open the door.
2. Make sure that the lint filter is installed.
3. Load your clothes into dryer loosely. Do not overload the machine.
4. Turn on your machine by pressing "On/Off" button. The "Cotton" & "Standard" indicator lights will be illuminated.
5. Select the desire program for you clothes, i.e. Mixed-(Full+1)-ANTI-CREASE
  - Continue to press "PROGRAM" button until the indicator for "Mixed" is illuminated.
  - Continue to press "dryness" button until the indicator for "Full+1" is illuminated.
  - Press "ANTI-CREASE" once and the indicator is illuminated.
6. Close the door.
7. Press "START/PAUSE" button to start the drying cycle.
8. When the drying cycle is finished, it will keep once time.
9. Open the door and wait for several minutes in order to let the temperature inside the capacity to cool down.
10. Turn off the machine by press "On/Off" button. All the indicator lights will go off.
11. Remove all of the clothes from the dryer.
12. Clean the drum and pull out the lint filter to clean before next use.

If you require any technical guidance or find that your product is not operating as intended, a simple solution can often be found in the **Troubleshooting** section of these instructions.

# Functions

Simple everyday use















Remarks: The door is equipped with a sensor. When the door is opened during the operation, the program will change to pause mode immediately. You can close the door and press "START/PAUSE" to continue the operation. If you want to stop the operation, please press "On/Off" to stop and off the machine.

## Full program chart & consumption table

Choose the appropriate program in the below table which affect the time of the drying cycle.

Mixed	Suitable for clothing comprising particularly thick or multi-layered materials and towels.
Cotton	Suitable for cotton clothing fabrics.
Synthetics	Suitable for light man-made fabrics.
1 HR	A timed program of approximately 1 hour. Dryness level will be dependent on the amount of clothes within the machine.

## Program Selection

Program	Dryness	Customer expected result	Max Capacity (KG)	Approx. Drying time (minutes)
Cotton 				
Cotton	Full + 1	Ready to wear 	7	150
Cotton 	Standard 	Ready to wear 	7	130
Cotton	Airing- 1	Ready to iron 	7	74
Synthetic 				
Synthetic	Full+ 1	Ready to wear 	3.5	65
Synthetic	Standard	Ready to wear 	3.5	50
Mixed				
Mixed	Full + 1	Ready to wear 	7	150
Mixed	Standard	Ready to wear 	7	130
Clothes equal or less than 1kg				
1Hr	/	/	<=1	60
Energy consumption values				
Program	Dryness	Customer expected result	Capacity (KG)	Energy consumption value kWh
Cotton 				
Cotton 	Standard 	Ready to wear 	7	4.38

- Please note that different program will have different max loading / capacity.
- All values given in the table have been fixed according to EN61121:2012 Standard. These values may deviate from the table according to the laundry type, laundry spin speed, environment condition and voltage fluctuation.
- When the weight of the clothed is less than 1kg, please use the "1HR" program.

or online at [www.argos-support.co.uk](http://www.argos-support.co.uk) If you still require further assistance, call one of our experts on 0345 257 7271.

# Functions

Simple everyday use

## Ending the program – Cancelled by customer

To cancel the program:

1. Press "On/Off" button.
2. The machine will stop immediately.
3. Open the door and wait for five minutes to let the temperature inside cool down.
4. Remove the clothes.



**Warning:** The temperature inside the capacity may still be high. Take extra care when remove the clothes.

- Clean the drum and lint filter after each drying.

## Child safety lock

This machine is equipped with a child safety lock (🔒) to prevent any program interruption due to the pressing of buttons during the drying operation. All the buttons the panel are deactivated when the child safety lock is active except the On/Off button.

- To activate the lock: press both Dryness and program button for 3 seconds, the child safety lock indicator will be illuminated and denoting entering the child-lock state.
- To deactivate the lock: press both Dryness and program buttons for 3 seconds, the child safety lock indicator will go off denoting that the lock is released.

## Overheat Safety device

This machine is equipped with an overheat safety device that switches off the machine in the event of overheating. Should the machine stop heating, turn the machine off and inspect lint filter or exhaust outlet or ventilation of the laundry room. Blockage on the filter & exhaust outlets (hose) and poor ventilation in laundry room will cause the overheating on the machine. Clean the blockage on filter & exhaust outlet and open the window in the laundry room to improve the situation. Wait for at least 10 minutes for the machine to cool down. Then press the reset key at the back of the machine before attempting to restart the machine.



If you require any technical guidance or find that your product is not operating as intended, a simple solution can often be found in the **Troubleshooting** section of these instructions.

Using your <tumble dryer>

5



# Using your <tumble dryer>

## Getting the most from your appliance

### Before first use

Final checks before operating the appliance

1. Good air circulation around the appliance positioned appliance.
2. The feet have been adjusted for perfect leveling.
3. Check the hose has been extended to the outdoors.
4. Plug in the appliance.

### Garments suitable for drying in tumble dryer

Before using the tumble dryer, you have to ensure the laundry is suitable to dry in the tumble dryer. Always follow the advice on the garment labels. Dry only laundry with a label stating they are suitable for drying in the dryer and select the appropriate program.

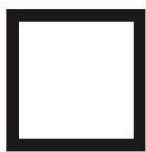

Dry



Do not dry



Do not tumble dry



Tumble dry, high heat



Tumble dry, middle heat

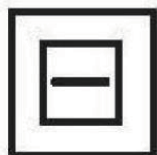

Dry horizontally



Hang without spinning



Dry on a hanger

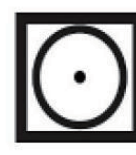

Tumble dry, low heat

### Garment NOT suitable for drying in tumble dryer

- Do not dry articles that have been previously cleaned in, washed in, soaked in or spotted with Petrol,/gasoline, dry-cleaning solvents or other flammable or explosive substances as they give off vapors that could ignite or explode.
- Do not dry the articles containing rubber, plastic or similar elastic materials such as padded bras, tennis shoes, galoshes, bath mats, rugs, bibs, baby pants, raincoat plastic bags or pillows that may melt or burn. Some rubber materials, when heated, can under certain circumstances produce fire by spontaneous combustion.
- Do not dry clothes / articles made of foam or rubber as they may be deformed.
- Clothes / articles made of containing meal, hard plastic and similar materials, such as belt buckles, jeans, bra wires, buttons and similar accessories will damage the machine and may cause breakdown.
- Do not place such items in the tumble dryer.
- Do not dry items such as woolen, silk articles and nylon stockings, delicate embroidered fabrics, garments with metal accessories and items such as sleeping bags.
- Too wet laundry or laundry with dripping water must not be put into the tumble dryer.

### Preparation for the clothes to be dried

- Thoroughly spin the laundry in washing machine. High spin speed can reduce the drying time and save energy consumption.
- Separate your laundry before placing them into the tumble dryer.
- Sort the laundry according to their types thickness. Put the same type of laundry together.

If you require any technical guidance or find that your product is not operating as intended, a simple solution can often be found in the **Troubleshooting** section of these instructions.

# Using your <tumble dryer>

Getting the most from your appliance

## Load capacity



**Caution** : Overload is not recommended. The drying performance will be degraded when it is overloaded. The machine and your clothes may get damaged. Please refer to the program table to select the desire loading for each setting. Do not overload the machine.

- Following table can provide you the idea of the weight for different kind of clothes.

Articles / Clothes	Approx. Weight(g)
Cotton quilt covers(single/double)	900/1500
Bed sheets (single/double)	600/900
Work clothes	1120
Large tablecloths	700
Small tablecloths	350
Tea napkins	100
Bath towels	700
Hand towels	300
Blouses	150
Cotton shirts	300
Shirts	180
Cotton dressed	500
Jeans	800
Jacket	800
Handkerchiefs	100
T-shirts	150
Shorts	70
Socks	50

- Place your clothes into dryer loosely so that they have enough room during and will not get tangled.

# Using your <tumble dryer>

Getting the most from your appliance

## Quick start

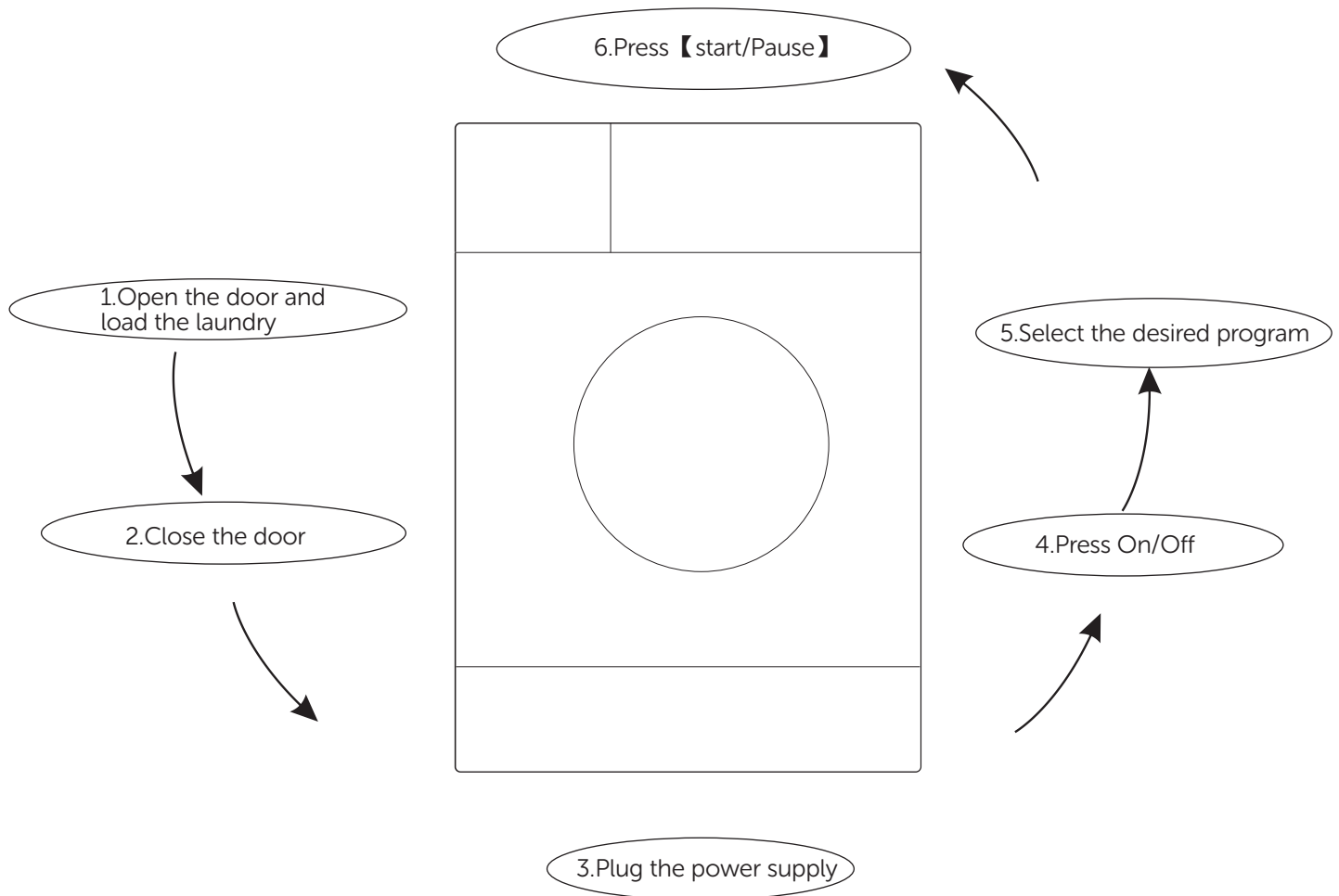

If you require any technical guidance or find that your product is not operating as intended, a simple solution can often be found in the **Troubleshooting** section of these instructions.



# Care and maintenance 6



# Care and maintenance

## Looking after your appliance

### General



**Important: Always unplug the appliance from the power socket during cleaning and maintenance.**

- Never use any sharp instruments or abrasive substance, soap, household cleaner, detergent or wax polish for cleaning.
- Use luke warm water to clean the cabinet of the appliance and wipe it dry.
- Never clean the appliance with flammable fluids. It could cause a damage and fire hazard.
- Clean the exterior of the appliance, inner tube and door seal with a damp cloth. Open the door for aeration to dry the inner tube through.
- Avoid water going in the control panel. Clean with a dry cloth only.
- Clean the lint filter after each use.

### Clean the lint filter



**Important: Always unplug the appliance from the power socket during cleaning and maintenance.**

- Clean the lint filter after each use.
- Pull it upward to remove the filter from the machine.
- Clean the filter with a damp cloth.
- Put it back to the machine after cleaning.



If you require any technical guidance or find that your product is not operating as intended, a simple solution can often be found in the **Troubleshooting** section of these instructions.

# Care and maintenance

Looking after your appliance

## Technical specification

Model	V7SDW V7SDS V7SDB
Energy efficiency class	C
Energy consumption – per year	510kWh
Rated capacity (max.)	7kg
Operating noise level dB(A)	69
Product dimension	H840xW595xD550
Net Weight	33kg
Rated power input	2000W
Rated voltage/Frequency	220-240V~/50Hz
Minimum operation temperature	-10° C

**NOTE:**

1 A+++ (most efficiency) to D (least efficiency)

2 Energy consumption 510 kWh per year, based on Standard cotton program at full (7kg) and partial (3.5kg) load, and the consumption of the low-power modes. Actual energy consumption per cycle will depend on how the appliance is used.

We apologise for any inconvenience caused by any minor inconsistencies in these instructions, which may occur as a result of product improvements and development.

# Care and maintenance

Looking after your appliance

## Product fiche

Brand	BUSH
Model	V7SDW/V7SDS/V7SDB
Dryer Type	Air-Vented
Rated capacity	7 kg
Energy efficiency class <b>1</b>	C
Energy consumption <b>2</b>	510 kWh
Automatic or non-automatic	Automatic
EU Ecolabel	N/A
Energy consumption of the standard cotton programme at full load	4.38 kWh
Energy consumption of the standard cotton programme and partial load	2.38 kWh
Power consumption of the off-mode (Po)	0.46 W
Power consumption of the left-on mode (PI)	0.46 W
Duration of the left- on mode	10 min
Weighted programme time of the standard cotton programme at full and partial load	100 min
Programme time of the standard cotton programme at full load	130 min
Programme time of the standard cotton programme at partial load	74 min
Sound power level for the standard cotton programme at full load	69 dB
Cotton + Standard programme, which is the "standard cotton programme" Used at full and partial load is the standard drying programme to which the Information in the label and the fiche relates, that this programme is suitable for Drying normal wet cotton laundry and that it is the most efficient programme in Terms of energy consumption for cotton.	

### NOTE:

1 A+++ (most efficiency) to D (least efficiency)

2 Energy consumption 510 kWh-per year, based on 160 drying cycles of the standard cotton programme at full and partial load, and the consumption of the low-power modes/ Actual energy consumption per cycle will depend on how the appliance is used.

We apologise for any inconvenience caused by any minor inconsistencies in these instructions, which may occur as a result of product improvements and development.

If you require any technical guidance or find that your product is not operating as intended, a simple solution can often be found in the **Troubleshooting** section of these instructions.

Product support

7



# Product support

Help is always at hand

## Troubleshooting

### 1. Tumble dryer doesn't operate?

Please make sure the power plug was inserted well and check the protection devices and fuses.

### 2. Laundry has shrunk?

Please review the advice on the garments label to select the suitable program setting.

### 3. Laundry not dry enough at the end of drying?

Please reduce the quantity of clothes for drying each time and clean the lint filter after each use.

### 4. Laundry too dry?

Please take out the clothes immediately while the drying cycle is finished and review the advice on the garments label to select the suitable program setting.

### 5. The tumble dryer has noisy?

Please make sure the tumble dryer was installed on even surface and leveling the appliance.

If you require any technical guidance or find that your product is not operating as intended, a simple solution can often be found in the **Troubleshooting** section of these instructions.

# Product support

Help is always at hand

## Help and assistance

If you require any technical guidance or find that your <tumble dryer> is not operating as intended, a simple solution can often be found in the **Troubleshooting** section of these instructions or online at [www.argos-support.co.uk](http://www.argos-support.co.uk)

If you still require further assistance, call one of our experts on **0345 257 7271\*** To help give us give you a fast and efficient service please have the following information ready:

Model Ref.	<input type="text"/>	You can find these on the rating plate - a small information panel (usually a sticker or metal plate) on the rear of your appliance
Serial number	<input type="text"/>	
Date of purchase	<input type="text"/>	This will be shown on your receipt

Local call rates applies\*

Lines open 8am-7pm Monday to Saturday and 10am-4pm Sunday.

\*Calls to Argos enquiry lines may attract a charge and set up fee from residential lines depending on your call plan/tarif. Mobile and other providers costs may vary, see [www.bt.com/pricing](http://www.bt.com/pricing) for details.

For Security and training purposes, telephone calls to and from customer service centres maybe recorded and monitored. Calls from Republic of Ireland will attract international call charges.

or online at [www.argos-support.co.uk](http://www.argos-support.co.uk) If you still require further assistance, call one of our experts on **0345 257 7271**.

# Product support

Help is always at hand



This appliance complies with the following EEC directives:  
2006/95/EEC low voltage directive  
2004/108/EMC directive

## Notes on disposal:



This marking indicates that this product should not be disposed with other household wastes throughout the EU. To prevent possible harm to the environment or human health from uncontrolled waste disposal, recycle it responsibly to promote the sustainable reuse of material resources. To return your used device, please use the collection systems or contact the retailer where the product was purchased. They return and can take this product for environmental safe recycling.

**Remember: Old machine must be disposed of carefully – Cut off the mains plug and /or remove the door to be unusable before disposed – if in doubt, contact your local council for details on how to dispose of an old dryer.**

If you require any technical guidance or find that your product is not operating as intended, a simple solution can often be found in the **Troubleshooting** section of these instructions.



# Product support

Help is always at hand

# BUSH

## Call us now and activate your 12 month guarantee

Thank you for choosing Bush. Your new product is guaranteed against faults and breakdowns for 12 months. Don't forget to register it with us today so we can provide you with our best possible after-sales service and useful updates.

[www.bushregistration.co.uk](http://www.bushregistration.co.uk)

FREEPHONE\*

**0800 597 8548**

Lines are open 8am - 8pm, 365 days a year. \*Calls may be recorded and monitored.

## Your Bush Guarantee

This product is guaranteed for twelve months from the date of original purchase. Any defect that arises due to faulty materials or workmanship will be repaired free of charge (or if applicable the product will be replaced or the purchase price refunded) where possible during this period by the dealer from who your purchased the unit.

The guarantee is subject to the following provisions:

- The guarantee does not cover accidental damage, misuse, cabinet parts, knobs or consumable items.
- The product must be correctly installed and operated in accordance with the instructions contained in the manual.
- It must be used solely for domestic purposes. The guarantee will be rendered invalid if the product is re-sold or has been damaged by inexpert repair.
- Specifications are subject to change without notice.
- Bush disclaim any liability for loss or damage arising from the breakdown of the product.
- This guarantee is in addition to and does not diminish your statutory or legal rights.

## Important Data Protection Information

If you provide us with information about another person, you confirm that they have appointed you to act for them, to consent to the processing of their personal data including sensitive personal data and that you have informed them of our identity and the purposes (as set out in the Important Data Privacy notice displayed overleaf) for which their personal data will be processed.

You are entitled to ask for a copy of the information we hold about you (for which we may charge a small fee) and to have any inaccuracies in your information corrected.

For quality control and training purposes, we may monitor or record your communications with us.

If your personal details change, if you change your mind about any of your marketing preferences or if you have any queries about how we use your information, please let us know by contacting our Data Protection Officer, Domestic & General, Leicester House 17 Leicester Street, Bedworth, Warwickshire CV12 8JP.

Guarantor: Argos Limited - 489 - 499 Avebury Blvd. - Milton Keynes - MK9 2NW

or online at [www.argos-support.co.uk](http://www.argos-support.co.uk) If you still require further assistance, call one of our experts on **0345 257 7271**.





# BUSH

**Contact:**

[www.argos-support.co.uk](http://www.argos-support.co.uk)

Helpline: 0345 257 7271