



Russell Hobbs



instructions

£10,000 prize draw
EXTRA year guarantee
FREE rewards gallery
Register online now!
See back for details
www.russellhobbs.co.uk/productregister/

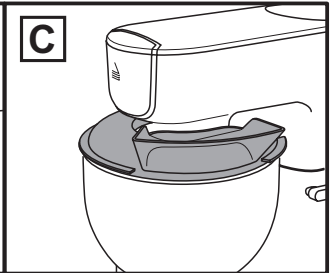
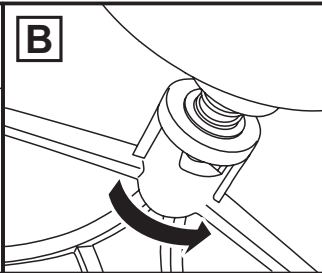
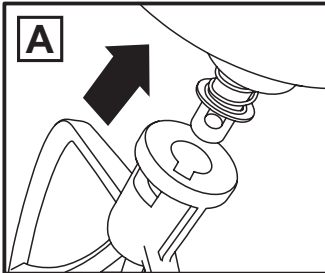
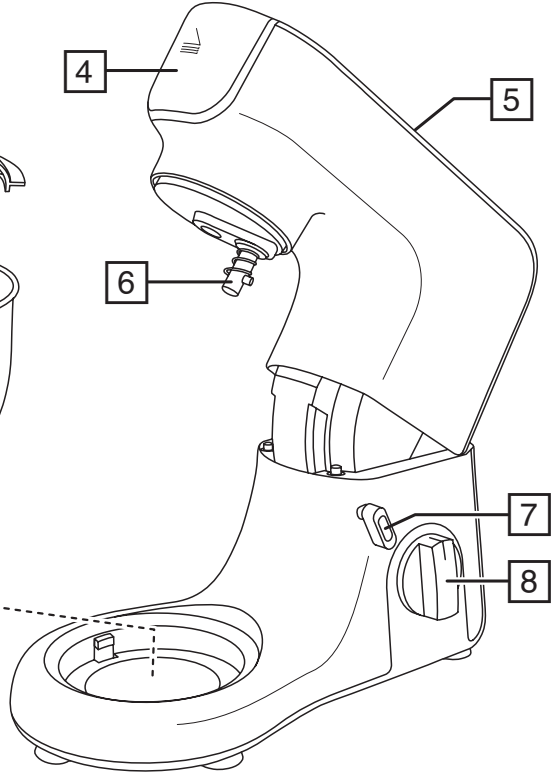
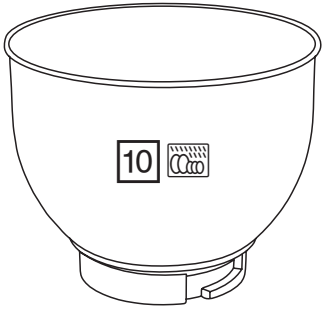
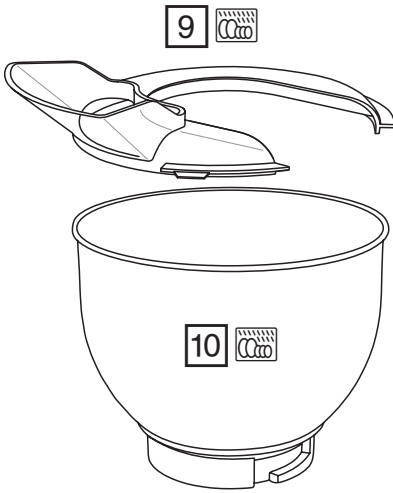
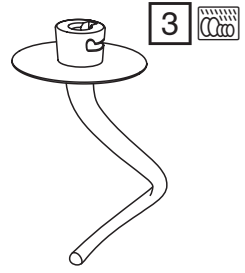
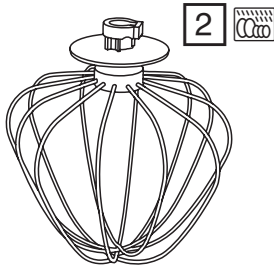
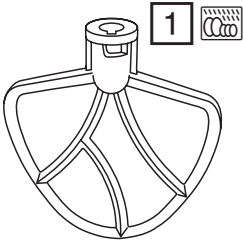

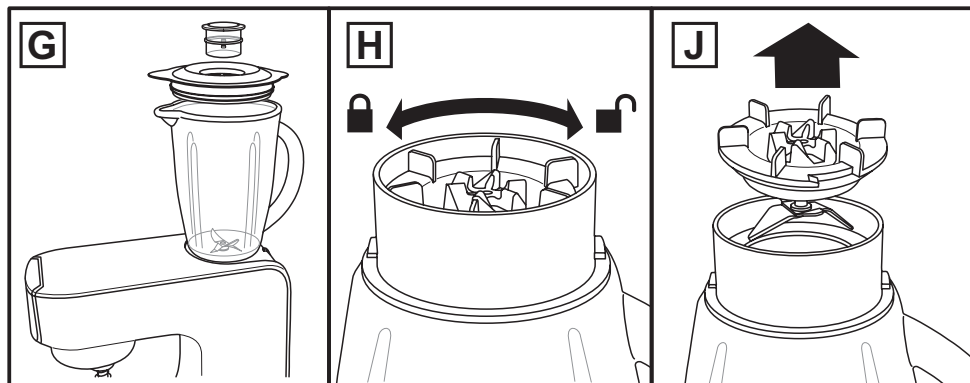
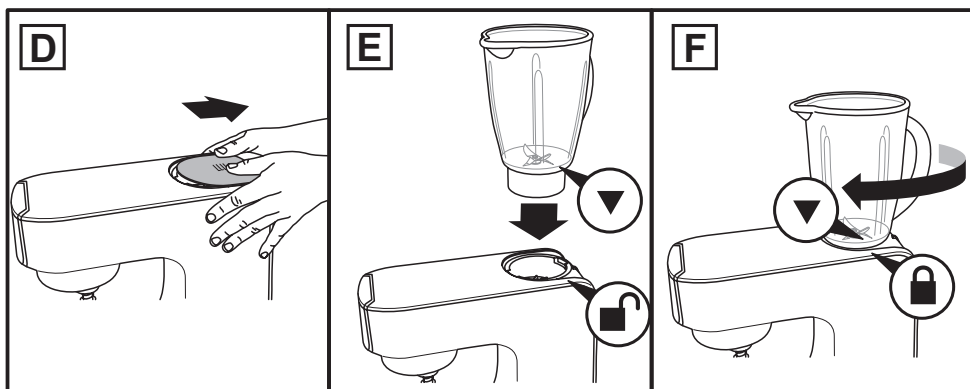
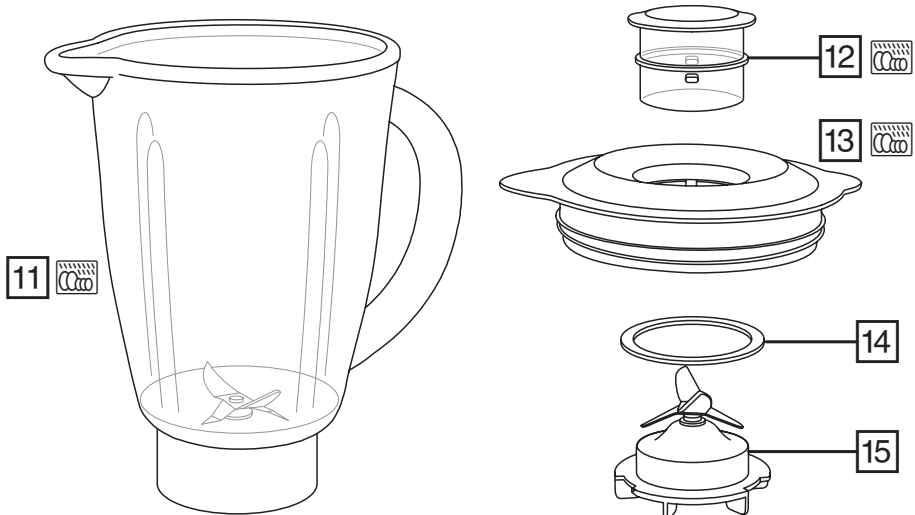

Read the instructions, keep them safe, pass them on if you pass the appliance on.
Remove all packaging before use.

IMPORTANT SAFEGUARDS

Follow basic safety precautions, including:

This appliance can be used by persons with reduced physical, sensory or mental capabilities or lack of experience and knowledge if they have been supervised/instructed and understand the hazards involved.

Children must not use or play with the appliance. Keep the appliance and cable out of reach of children.

Always disconnect the appliance from the mains supply socket if it is left unattended and before assembling, disassembling or cleaning.

Care must be taken when handling sharp cutting blades during emptying and cleaning.

 Never process liquid over 40°C, as it may be ejected due to steaming.

Don't run the appliance for more than 10 minutes. After 10 minutes, switch off for at least 20 minutes.

If the cable is damaged, return the appliance, to avoid hazard.

- Don't put the motor unit in liquid, don't use it in a bathroom, near water, or outdoors.
- Keep fingers, hair, clothing, kitchen utensils, etc. clear of the bowl and attachments.
- Don't use the appliance for any purpose other than those described in these instructions.
- Don't use attachments or accessories unless we supply them.
- Don't use the appliance if it's damaged or malfunctions.
- Don't use the blender at the same time as the mixer.

HOUSEHOLD USE ONLY

PARTS

- | | |
|---|---|
| 1. Beater | 9. Splash guard |
| 2. Whisk | 10. Bowl |
| 3. Dough hook | 11. Blending jug |
| 4. Accessory drive (for optional accessories) | 12. Cap |
| 5. Arm | 13. Lid |
| 6. Drive shaft and pin | 14. Seal |
| 7. Arm lock lever | 15. Blade |
| 8. Speed control |  Dishwasher safe |

POSITIONING

1. Sit the appliance on a water-resistant, dry, stable, level surface.
2. Route the cable so it doesn't overhang, and can't be tripped over or caught.
3. Don't plug it in until you have finished assembling it.

FOOD MIXER

ASSEMBLY

Raising the arm:

1. The springs in the arm are powerful so place your hand on top of the arm to control its movement.
2. Turn the arm lock lever to the  position and hold it there. The arm will rise.

Lowering the arm:

1. Turn the arm lock lever to the  position and hold it there.
2. Press the arm down and, while holding it there, release the arm lock lever.

Fitting the bowl

Raise the arm before fitting or removing the bowl. Use only the bowl supplied.

1. Fit the bowl into the recess in the base and turn it clockwise until it locks.
2. To remove, turn it anti-clockwise then lift it off the base.

Fitting/removing attachments

Switch off, unplug and raise the arm before fitting or removing attachments.

1. Align the slot in the attachment with the pin on the drive shaft (Fig A).
2. Push the attachment onto the drive shaft then turn it anti-clockwise to lock it (Fig B).

To remove an attachment, push it upwards slightly then turn it clockwise and pull it off the shaft.

Splash guard

The splash guard protects you from spills or splashes during mixing while still allowing you to add ingredients. Switch off and unplug your mixer before fitting/removing the splash guard.

With the bowl in position and the arm in the lowered position:

1. Slide the splash guard between the arm and the bowl.
 2. Align it so that the opening is on the right hand side (Fig C).
- Always remove the splash guard before raising the arm.

USING YOUR MIXER



1. Check that the speed control is set to **O**.
2. Put the plug into the power socket (switch the socket on, if its switchable).
3. Turn the speed control clockwise to the speed you want.
4. The range is from **1** (low) to **10** (high). Turn the speed control back to **O** to turn the motor off.
5. To operate the motor in short bursts, turn the speed control to the  position. Release the control to stop the motor.

Recommended Speeds



Attachment	Speed	Use for
Whisk	7-10	beating/aerating cream, egg whites, batter, light mixes
Beater	4-7	creaming butter and sugar, medium cake mixes
Dough hook	1-4	heavy mixtures, bread, pastry

BLENDER

ASSEMBLY

1. Slide off the blending jug drive cover (Fig D).
2. Insert the jug into the drive opening with the ▼ mark on the jug aligned with the  mark on the mixer (Fig E).
3. Twist the jug clockwise until the ▼ mark on the jug is aligned with the  mark on the mixer (Fig F).
4. Add the ingredients to the the jug and fit the lid and cap (Fig G). Don't fill past the max mark on the jug. Never use the jug without the lid fitted.

USING YOUR BLENDER

1. Check that the speed control is set to **O**.
2. Put the plug into the power socket (switch the socket on, if its switchable).
3. Turn the speed control clockwise to the speed you want.
4. The range is from **1** (low) to **10** (high). Turn the speed control back to **O** to turn the motor off.
5. To operate the motor in short bursts, turn the speed control to the  position. Release the control to stop the motor.
6. If you need to add other ingredients during blending, turn the cap anticlockwise and lift it off. Add the ingredients then replace the cap and turn it clockwise to lock it.
7. When you have finished blending, turn the speed to control to **O** and wait for the blades to stop before removing the lid from the jug or the jug from the mixer.
8. To remove the jug, twist it anticlockwise until the ▼ mark is aligned with the  mark.

CARE AND MAINTENANCE

Switch off (O) and unplug before cleaning.



Mixer:

1. Clean as soon after use as possible to prevent residues setting inside the bowl.
2. Wash the bowl, splash guard and attachments in warm soapy water, rinse, and dry.
3. You may put the bowl and attachments in a dishwasher, but note: the harsh environment inside the dishwasher will affect the surface finishes. The damage should be cosmetic only, and should not affect the operation of the appliance.
4. Wipe the outside surfaces of the appliance with a clean damp cloth.

Blending jug:

1. Wash the blending jug, cap and lid in warm soapy water. Rinse and dry.
2. You may wash the jug, cap and lid in a dishwasher. However, we recommend that you remove the blade before washing in a dishwasher.

To remove the blade:

1. Turn the jug upside down.
2. Twist the blade clockwise in the direction of the  symbol (Fig H).
3. Carefully lift out the blade unit (Fig J). **Take care, the blades have very sharp edges.**
4. Remove the seal and carefully wash the blade and seal in warm soapy water. Rinse and dry.
5. Refit the seal to the blade then lower the blade into the jug and twist it as far as it will go anticlockwise in the direction of the  symbol (Fig H). Make sure the seal is fitted and the blade is fully tightened otherwise the jug may leak during use.

MIXER RECIPES

PIZZA DOUGH

- 400g plain flour
- 1 sachet active dried yeast (about 2½ tsp)
- 250ml warm water
- 25ml olive oil
- 2.5g sugar
- 5g salt

Put the flour in the bowl. Mix the other ingredients in a jug. Select speed 1, and slowly add the liquid. As the dough ball forms, increase speed to 2, and knead for a couple of minutes, till the dough ball is smooth. Remove, split into 2-4 pieces, and roll into pizza bases (circles or rectangles) on a floured surface. Lay them on a baking sheet or pizza tray, spread with tomato purée and add your desired toppings. Top with dried herbs, torn mozzarella and a drizzle of olive oil. Bake in a preheated oven at 200°C/400°F/gas 6 for 15-20 minutes, till the toppings are bubbling and golden brown.

dough hook

CURRANT LOAF (1kg/2lb loaf)

- 500g wholemeal flour
- 150g butter (softened)
- 15g baking powder
- 2.5g salt
- 150g sugar
- 150g currants
- 50g mixed peel
- 2 eggs (medium)
- 30ml milk

Put the flour in the bowl, add the softened butter, and mix on speed 1. When the butter and flour start to blend, add the sugar, salt, currants, peel and baking powder. Leave it mixing while you beat the eggs and milk together, then add the egg/milk mixture to the bowl. Select speed 2 and mix till combined. Put into a greased loaf tin and bake in a preheated oven at 180°C/350°F/gas 4 for 35 minutes. Cool on a wire rack before slicing. Serve toasted with butter.

dough hook

BASIC WHITE BREAD (1kg/2lb loaf)

- 600g strong white bread flour
- 1 sachet active dried yeast (about 2½ tsp)
- 345ml warm water
- 15ml sunflower oil or butter
- 5g sugar
- 10g salt

dough hook

Mix as for pizza dough, then cover and leave in a warm place till doubled in size (30-40 minutes). Punch down to remove air, knead lightly on a floured board, shape it into a loaf, or put it in a tin, cover, and leave in a warm place to rise for another 30 minutes. Bake in a preheated oven at 200°C/400°F/gas 6 for 25-30 minutes, till golden brown and hollow sounding on the bottom.

BASIC WHOLEMEAL BREAD (1kg/2lb loaf)

dough hook

- 575g strong wholemeal bread flour
- 1 sachet active dried yeast (about 2½ tsp)
- 375ml warm water
- 30ml sunflower oil or butter
- 15g light brown sugar
- 10g salt

Follow the method for basic white bread.

SOFT POPPY SEED ROLLS (8-10 rolls)

dough hook

- 570g strong white bread flour
- 1 sachet active dried yeast (about 2½ tsp)
- 300ml milk (warmed slightly)
- 2 eggs (room temperature)
- 15ml sunflower oil
- 8g sugar
- 10g salt
- 75g poppy seeds

Mix the milk, eggs, oil, sugar, salt and yeast in a jug. Leave for 5 minutes. Put the flour and poppy seeds in the bowl. Mix at speed 1, gradually adding the liquid, increase speed to 2, and mix for five minutes. Cut into 8-10 pieces, then roll into shape, on a floured surface. Leave on a baking sheet, in a warm place, till doubled in size. Brush with egg or milk, and bake in a preheated oven at 220°C/425°F/gas 7 for 20-25 minutes, till golden brown and hollow sounding on the base.

ITALIAN HERB BREAD (1kg/2lb loaf)

dough hook

- 575g strong white bread flour
- 1 sachet active dried yeast (about 7g)
- 290ml lukewarm water (30°-35°C)
- 30ml olive oil
- 10g sugar
- 10g salt
- 60g mixed dried herbs

Mix the water, oil, sugar, salt and yeast in a jug, and leave for 5 minutes. Put the flour and dried herbs in the bowl. Select speed 1. Gradually add the liquid, increase speed to 2, and mix for five minutes. Cover the dough, and leave in a warm place till doubled in size (20-30 minutes). Knead gently on a floured surface, to knock out the air, then shape, put on a baking sheet, and leave in the warm till doubled in size. Bake in a preheated oven at 200°C/400°F/gas 6 for 25 minutes, till golden brown and hollow sounding on the bottom.

APRICOT, LEMON AND RUM PANCAKES

whisk

- 100g plain flour
- 25g ground almonds
- 50g dried apricots
- 300ml milk
- 1 egg
- 25g butter (melted)
- grated rind of ½ lemon
- 30-45ml rum
- pinch salt
- oil for frying

Soak the dried apricots overnight in the rum. Mix the egg, milk, lemon rind and melted butter in a jug. Sift the flour into the bowl, add the ground almonds and salt, and whisk at speed 3, gradually adding the liquid. Increase speed to 5 or 6, as everything is incorporated, then whisk till smooth. Heat the oil in a frying pan and drop in tablespoons of batter. Cook for a minute or so on each side till golden. Put in a stack and keep warm. Purée the rum and apricots in a blender, put a little purée on each pancake and roll up. Serve warm with cream or ice cream.

HOT CHOCOLATE SOUFFLÉ

whisk

- 75g butter
- 50g plain flour
- 10g cocoa powder
- 450ml milk
- 4 eggs, separated
- 50g caster sugar

Melt the butter in a pan over a low heat. Stir in the flour and cocoa, then the milk and stir till thickened slightly. Remove from the heat, let it cool, then beat in the egg yolks. Put the whites in the bowl, mix at speed 6 for a few seconds, add the sugar and whisk till soft peaks form. Fold in the sauce. Pour the mixture into a greased 1.2 litre (2 pint) dish. Bake, in the oven, in a roasting tin half filled with boiling water, at 190°C/375°F/gas 5 for 40-45 minutes, till well risen.

CHICKEN AND PESTO PANCAKE WRAPS

whisk

Pancake wraps:

- 100g plain flour
- 1 large egg
- 300ml milk
- 2.5g salt
- oil for frying

Filling:

- 90g pesto (green or red)
- 2 cooked chicken fillets, shredded
- 75g Gruyere cheese, grated
- 50g Parmesan cheese, grated

handful of baby plum tomatoes large handful of fresh basil leaves

Mix the egg and milk in a jug. Sift the flour and salt into the bowl. Select speed 3. Gradually add the liquid, increase speed to 5 or 6, and whisk till smooth and light. Cook small amounts of batter in a hot saucepan coated with oil for a minute each side, till golden brown. Set aside and keep warm. Chop the tomatoes, tear the basil into shreds, spread each pancake wraps with a little pesto, add cooked chicken, chopped tomatoes, and basil. Season, roll up, and put in an ovenproof dish. Sprinkle with the two cheeses. Brown under a hot grill till golden and bubbling.

COFFEE AND BRANDY ICE CREAM

whisk

- 3 eggs
- 75g caster sugar
- 300ml single cream
- 30g instant coffee powder
- 300ml double cream
- 40ml brandy

Whisk the sugar and eggs at speed 6 till smooth. Put the single cream and coffee in a pan, bring just to the boil, then stir in the egg and sugar mixture. Put in a heatproof bowl over a simmering pan of water and cook gently, stirring well, till thick enough to coat the back of a spoon. Strain into a bowl and leave to cool. Whip the double cream at speed 6 till soft peaks form, then fold into the cold egg and sugar mixture, with the brandy. Pour into a container, cover, and freeze for 2½-3 hours, till partially frozen. Remove, stir well, then freeze again, till the texture suits you.

BASIC BISCUITS

whisk

- 100g butter
- 150g caster sugar
- 5ml vanilla essence
- 1 medium egg
- 100g plain flour
- 100g self raising flour

Cream the butter, sugar and vanilla at speed 5 for 1-2 minutes till light, pale and fluffy, add the egg, and whisk till combined. Sift the flours together then gradually add them to the mixture. Remove the bowl, form the mixture into balls, and flatten them. Bake on a greased tray, in a preheated oven at 180°C/350°F/gas 4 for 12-15 minutes. Cool on the tray, then on a wire rack.

BASIC MERINGUES

whisk

- 4 egg whites
- 100g caster sugar
- 100g icing sugar

:Combine the sugars and set aside. Whisk the egg whites at speed 6 till fairly stiff. Add half the sugar and whisk till stiff peaks form. Remove the bowl, and fold in the remaining sugar with a metal spoon. Line a baking sheet, spoon the meringue into ovals, sprinkle with the remaining sugar, and cook on the bottom oven shelf at 120°C/250°F/gas ½ for 1½ hours. Cool on a rack.

CLASSIC VICTORIA SPONGE CAKE

whisk

- 100g butter/margarine
- 100g caster sugar
- 2 large eggs
- 100g self raising flour
- 1 drop vanilla essence

Grease two 18cm (7") straight sided sandwich tins. Line the bases with greased greaseproof paper. Cream the butter and sugar at speed 3 till light and fluffy, gradually add the eggs, then the vanilla, then the flour. Increase speed to 4 once the ingredients start to incorporate. Divide the mixture between the tins and level the surfaces. Bake in the centre of a preheated oven at 180°C/350°F/gas 4 for about 25 minutes. Cool on a wire rack.

STEAMED TREACLE PUDDING

beater

- 100g caster sugar
- 2 eggs
- 100g self raising flour
- 75g golden syrup
- 100g butter
- extra butter for greasing

Grease a 900ml pudding basin. Whisk the butter and sugar at 2-3 till light and fluffy. Add an egg, then a little flour, then the other egg, then the remaining flour. Put the syrup in the pudding basin, and pour the mixture on top. Cover with greaseproof paper or foil, secure with string and steam for 1½-2 hours. Serve hot with custard or cream.

VERY MOIST CHOCOLATE CAKE

beater

- 50g butter, softened
- 30g golden syrup
- 50ml milk
- 2 eggs, beaten
- 125g caster sugar
- 100g cooking chocolate, melted
- 10ml vanilla extract
- 100ml boiling water
- 35g cocoa powder
- 125g self raising flour
- 30ml light vegetable oil (sunflower, etc.)

Dissolve the cocoa in the boiling water and leave to cool. Cream the butter and sugar for a few seconds at 1, add half the egg, then half the flour, gradually increasing the speed to 3, add the remaining egg and flour, mix till smooth, add the other ingredients and mix till smooth. Put in a dish, cover with foil and steam for 1 hour, or till a skewer pushed into the cake comes out clean.

FARMHOUSE FRUIT CAKE

beater

- 150g butter
- 150g caster sugar
- 75g glacé cherries, chopped
- 75g each of sultanas and raisins
- 25g mixed peel
- 300g self raising flour
- Pinch salt
- 5g mixed spice
- 45ml milk
- 3 eggs

Grease a 20cm (8") cake tin. Line with greaseproof paper. Preheat the oven to 180°C/350°F/gas 4. Put the butter, sugar, dried fruits and spices in the bowl, and beat at speed 3 till combined. Add the eggs and milk and beat for a few seconds. Gradually add the flour, beating till well mixed. Bake in the cake tin for about 1½ hours. Cool in the tin for 15 minutes then turn on to a wire rack.

SPONGE MIXTURE (BASIC RECIPE)

beater

- 500g plain flour
- 250g soft butter or margarine
- 250g sugar
- 2 drops vanilla essence
- 4 eggs
- 15g baking powder
- 125ml milk
- pinch of salt

Grease and line a deep 23cm (9") round cake tin. Preheat the oven to 190°C/375°F/gas 5. Put everything into the bowl, mix at speed 1 for 30 seconds, then at speed 3 for 3 minutes, till combined. Pour the mixture into the cake tin, and bake in the centre of the oven for 50-60 minutes, till a skewer pushed into the cake comes out clean. Cool on a wire tray. Vary the basic recipe by adding 100g raisins, chopped nuts, or grated chocolate.

BLENDER RECIPES

CORIANDER PESTO

- 4 handfuls fresh coriander leaf
- 4 cloves fresh garlic
- 120g pine nuts
- 250ml olive oil
- 120g freshly grated Parmesan

Put the coriander, garlic and pine nuts in the jug, add a spoon of oil, and process. Repeat till the oil's done, transfer to a big bowl, and mix in the Parmesan. Season with black pepper. Serve as a topping for soup, tossed through warm pasta, or as a dip.

BLACK OLIVE AND ANCHOVY SAUCE

- 250g pitted black olives
- 60g anchovy fillets, drained
- 45g capers, drained
- 150ml olive oil
- 10ml brandy (optional)
- fresh ground black pepper

Put everything but the oil into the bowl. Add a spoon oil and process for 5 seconds. Repeat till the consistency is as you want it. Toss through warm pasta or spread on toast.

HORSERADISH AND APPLE SAUCE

- 250ml double cream
- 2 sharp flavoured apple, peeled and grated
- 90ml horseradish relish
- 30g paprika

Process the cream till soft peaks form, then transfer to a bowl and fold in the other ingredients. Season with black pepper. Serve with beef or sausage.

SWEET AND SOUR SAUCE

- 4 shallots, peeled
- small piece fresh ginger, peeled
- 2 cloves garlic
- 30ml soy sauce
- dash white wine vinegar
- 10ml mustard
- 10ml tomato purée

Put everything into the jug and process till smooth. Serve with chicken or fish, or as a dip.

SPICY PUMPKIN SOUP

- 900g pumpkin
- 2 leeks, trimmed and sliced
- 900ml chicken or vegetable stock
- 30ml vegetable oil
- 2 cloves garlic, crushed
- 5g ground ginger
- 5g ground coriander
- bunch of fresh coriander leaves
- 30ml single cream or crème fraiche
- salt and pepper

Peel the pumpkin, remove the seeds, and cut the flesh into chunks, roughly chop the coriander. Heat the oil in a pan, add the leeks, garlic and spices, then stir till the leeks have softened slightly. Add the pumpkin and stock to the pan, bring to the boil, then simmer gently till the pumpkin is tender (20-30 minutes). Remove from the heat, and stir in the coriander and cream. Let the mixture cool for about 30 minutes, then blend at high speed, till it's really smooth. Return the mixture to the pan and heat to serving temperature (don't let it boil). Taste, adjust the seasoning, and serve with crusty bread.

LEEK AND POTATO SOUP (serves 4)

- 150g leeks, trimmed
- 150g potatoes, peeled
- 2 vegetable or chicken stock cubes
- 800ml water
- salt and pepper to taste

Blend the leeks and potatoes for a couple of seconds (you want them lumpy, not mushy).

Transfer to a pan, and add the water and stock cubes.

Bring to the boil, stirring, reduce the heat, cover the pan and simmer for 20 minutes.

Let the mixture cool for about 30 minutes, then blend at high speed, till it's smooth and silky.

Return the mixture to the pan and heat to serving temperature (don't let it boil).

Taste, adjust the seasoning, and serve with crusty bread.

BREAKFAST SMOOTHIE

- 4 tbsp natural yogurt
- 200ml milk
- 30g oatmeal or porridge oats
- 1 large banana, roughly chopped
- 10ml honey
- 2 apples, cored, roughly chopped

Put everything into the jug. Run at speed 2 for 10 seconds, then at speed 5 for 15 seconds.

NUTTY BANANA SMOOTHIE

- 150g hazelnut yogurt
- 1 large banana, roughly chopped
- 200ml milk

Put everything into the jug. Run at speed 2 for 10 seconds, then at speed 5 for 5 seconds.

MANGO LASSI

- 200ml natural yogurt
- 1 ripe mango, stoned, peeled, roughly chopped
- 200ml milk
- 10ml honey

Put everything into the jug. Run at speed 2 for 10 seconds, then at speed 5 for 5 seconds.

CHOCOLATE ORANGE SMOOTHIE

- 170g chocolate ice cream
- 300ml orange juice

Put everything into the jug. Run at speed 2 for 10 seconds, then at speed 5 for 5 seconds.

CHOCOLATE PEAR SMOOTHIE

- 300ml chocolate milk
- 2 pears, peeled, cored, roughly chopped

Put everything into the jug. Run at speed 2 for 15 seconds, then at speed 5 for 5 seconds.

STRAWBERRY AND BANANA SMOOTHIE

- 300ml milk
- 1 large banana, roughly chopped
- 12 strawberries, stalks removed

Put everything into the jug. Run at speed 2 for 10 seconds, then at speed 5 for 10 seconds.

BANANA, VANILLA AND HONEY SMOOTHIE

- 400ml milk
- 1 large banana, roughly chopped
- 20ml honey
- 10ml vanilla extract

Put everything into the jug. Run at speed 2 for 10 seconds, then at speed 5 for 5 seconds.

APPLE AND MANGO SMOOTHIE

- 600ml apple juice
- 1 ripe mango

Stone, peel and roughly chop the mango. Put everything into the jug. Run at speed 2 for 10 seconds, then at speed 5 for 10 seconds.

CREAMY BLUEBERRY AND VANILLA SMOOTHIE

- 360ml lemonade
- 125g vanilla ice cream
- 70g blueberries

Put everything into the jug. Run at speed 2 for 10 seconds, then at speed 5 for 10 seconds.

CRANBERRY, ORANGE AND BANANA SMOOTHIE

- 300ml orange juice
- 300ml cranberry juice
- 1 small banana, roughly chopped

Put everything into the jug. Run at speed 2 for 10 seconds, then at speed 5 for 5 seconds.

PEACH AND APRICOT SMOOTHIE

- 4 halves of tinned apricot (in juice)
- 80ml apricot juice (from tin)
- 2 peaches
- 60ml natural yogurt
- 200ml milk
- 10ml honey

Stone and roughly chop the peaches. Put everything into the jug. Run at speed 2 for 15 seconds, then at speed 5 for 15 seconds.

BERRY FRUITY SMOOTHIE

- 300ml apple juice
- 90g raspberries
- 12 strawberries, stalks removed

Put everything into the jug. Run at speed 2 for 15 seconds, then at speed 5 for 15 seconds.

APPLE, MELON AND KIWI FRUIT SMOOTHIE

- 400ml apple juice
- 1 kiwi fruit, peeled and roughly chopped
- 150g melon, roughly chopped

Put everything into the jug. Run at speed 2 for 10 seconds, then at speed 5 for 10 seconds.

VERY CHOCOLATEY CHERRY SMOOTHIE

- 350ml lemonade
- 125ml chocolate ice cream
- 100g cherries, stoned

Put everything into the jug. Run at speed 2 for 10 seconds, then at speed 5 for 10 seconds.



ENVIRONMENTAL PROTECTION

To avoid environmental and health problems due to hazardous substances in electrical and electronic goods, appliances marked with this symbol mustn't be disposed of with unsorted municipal waste, but recovered, reused, or recycled.

SERVICE

If you ring Customer Service, please have the **Model Number** to hand, as we won't be able to help you without it. It's on the rating plate (usually underneath the product).

The product isn't user-serviceable. If it's not working, read the instructions, check the plug fuse and main fuse/circuit breaker. If it's still not working, consult your retailer.

If that doesn't solve the problem – ring Customer Service – they may be able to offer technical advice.

If they advise you to return the product to us, pack it carefully, include a note with your name, address, day phone number, and what's wrong. If under guarantee, say where and when purchased, and include proof of purchase (till receipt). Send it to:

Customer Service

Spectrum Brands (UK) Ltd

Fir Street, Failsworth, Manchester M35 0HS

email: support@russellhobbs.com

telephone: 0845 658 9700 (local rate number)

GUARANTEE

Defects affecting product functionality appearing within two years of first retail purchase will be corrected by replacement or repair provided the product is used and maintained in accordance with the instructions. Your statutory rights are not affected. Documentation, packaging, and product specifications may change without notice.



ONLINE

www.russellhobbs.co.uk for more products



REGISTER ONLINE FOR –



£10,000 prize draw,

EXTRA year guarantee,

FREE rewards gallery

Visit www.russellhobbs.co.uk/productregister/

You must register within 28 days of purchase.