

A

A

B

B

技术要求:

1. 印刷颜色为**CMYK** 四色印刷;
2. 文档规格为**A4**, 要求按**A4**规格输出菲林和印刷;
3. 空白页的排版按文件制作。

C

C

D

D

						英文用户手册		6710020411	
						DWFSG126W,B(7601)			
						(BUSH)( 英国 )			
标记	处数	分区	更改文件号	签名	日期	阶段标记		比例	
设计				会签		REV.	00	1:1	
认证				审批		数量			
校对				日期		共 1 张		第 1 张	
							佛山市顺德区美的		洗涤电器制造有限公司

# BUSH

## Instruction manual

DWFSG126W  
DWFSG126B



You'll soon be enjoying your new dishwasher.

It all begins here, with your instructions. Don't worry, there's nothing too technical coming up. Just simple, step-by-step guidance to get you up and running quickly. Sound good? Then let's get started.

## Help and Guidance

We're here to help you get the most from your dishwasher. Should you require any guidance, a simple solution can often be found online at:

**[www.argos-support.co.uk](http://www.argos-support.co.uk)**

If you still require further assistance, call one of our experts on **0345 257 7271**.

# Contents

## 1 Safety information

Safety information 6

## 2 Getting to know your dishwasher

Ready? Let's begin 10

Accessories 12

## 3 Installing your dishwasher

Unpack the dishwasher 14

Water supply connection 14

Electrical connection 16

## 4 Functions

Functions 18

## 5 Using your dishwasher

First use of dishwasher 22

Rinsing Aid 23

Loading your dishwasher 24

Wash cycle table 26

## 6 Care and Maintenance

Cleaning 28

Cleaning the filter 28

Cleaning the spray arms 28

## 7 Product support

Troubleshooting 30

Help and assistance 32

Disposal information 33

Guarantee 34



# Safety information

1





## Safety information

**Important** - Please read these instructions fully before installing or operating

### Before use

The installation of this appliance is best carried out by 2 people.

- Dispose of all packaging carefully and responsibly.
- The appliance is designed for indoor use only and must be protected from rain, moisture and extreme temperature variations.
- This appliance is designed for household use. Do not use the appliance for industrial and commercial use, or any other purpose.
- The appliance **MUST** be positioned on a firm level base.
- Do not place the appliance near a heat source or in direct sunlight.
- Only suitable household utensils should be placed in the dishwasher. Avoid utensils that are non-heat-resistant, metal decorated, etc.
- Do not use detergent not designed for dishwasher. This may damage the appliance.
- Do not spray water on the appliance. It may cause electrical parts failure or electric shock.
- Do not stand or sit on the door when it is open. It may cause deformation or failure of your dishwasher. The appliance could tip forward.
- Do not put any heavy objects on top of the appliance. It will damage the appliance.
- This appliance is fitted with a safety function that automatically stops the operation of the dishwasher when it is exposed to heavy disturbance on its mains.
- The appliance is to be connected to the water supply using new hose set and that old hose set should not be used.
- The door should not be left in open position since this could present a tripping hazard.
- This appliance must be positioned so that the plug is accessible.
- This appliance is intended to be used in household and similar applications such as:  
-staff kitchen areas in shops, offices and other working environments;

- farm houses;
- by clients in hotels, motels and other residential type environments;
- bed and breakfast type environments.

### During use

- This appliance is not intended for use by persons (including children) with reduced physical, sensory or mental capabilities, or lack of experience and knowledge, unless they have been given supervision or instruction concerning use of the appliance by a person responsible for their safety. Children should be supervised to ensure that they do not play with the appliance.
- This appliance is not intended for use by young children or infirm persons unless they have been adequately supervised by a responsible person to ensure that they can use the appliance safely. Young children should be supervised to ensure that they do not play with the appliance.
- Do not touch the visual heating element during or immediately after use.
- Do not operate your dishwasher unless all enclosure panels are properly in place. Open the door carefully if the dishwasher is operating, there is a risk of water squirting out.
- **WARNING:** Knives and other utensils with sharp points must be loaded in basket with their points down or placed in a horizontal position. Avoid damage to the door seal.
- Load plastic items so that they do not come into contact with the visible heating element.
- Dishwasher detergents are strongly alkaline, they can be extremely dangerous if swallowed. Avoid contact with skin and eyes and keep children away from the dishwasher when the door is open.
- The door should not be left open, since this could increase the risk of tripping.
- Keep detergents away from children.
- Do not attempt to repair the appliance yourself. Contact the Customer Helpline: 0345 2577271



## Safety information

**Important** - Please read these instructions fully before installing or operating

- This appliance is intended to be used in household and similar applications such as:
  - staff kitchen areas in shops, offices and other working environments;
  - farm houses;
  - by clients in hotels, motels and other residential type environments;
  - bed and breakfast type environments.
- This appliance can be used by children aged from 8 years and above and persons with reduced physical, sensory or mental capabilities or lack of experience and knowledge if they have been given supervision or instruction concerning use of the appliance in a safe way and understand the hazards involved. Children shall not play with the appliance. Cleaning and user maintenance shall not be made by children without supervision.
- To protect against the risk of electrical shock, do not immerse the unit, cord or plug in water or other liquid.
- Please unplug before cleaning and maintenance the appliance.
- Use a soft cloth moisten with mild soap, and then use a dry cloth to wipe it again.
- If the supply cord is damaged, it must be replaced by the manufacturer, its service agent or similarly qualified persons in order to avoid a hazard.





# Getting to know your dishwasher

2



# Getting to know your dishwasher

You'll be up and running in no time

## Ready? Let's begin...

Please read these instructions carefully. They contain important information which will help you get the best from your dishwasher and ensure safe and correct installation and operation.

If you require any further assistance, our technical experts are happy to help. For full details, refer to the product support section at the end of these instructions.

If you require any technical guidance or find that your product is not operating as intended, a simple solution can often be found in the **Troubleshooting** section of these instructions,

# Getting to know your dishwasher

You'll be up and running in no time

Front view



Back View

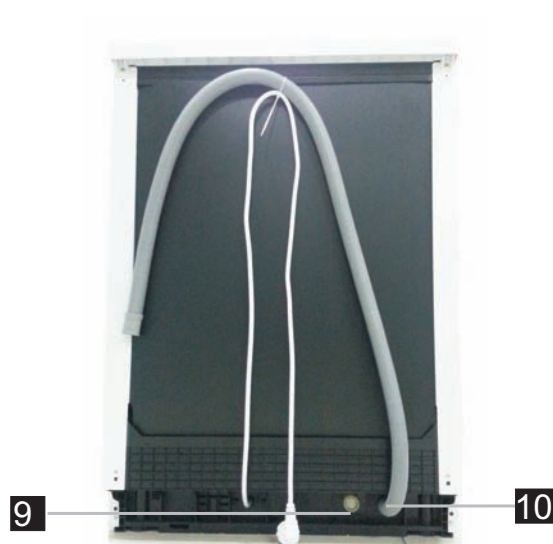

- 1. Upper Basket
- 2. Inner pipe
- 3. Lower Basket
- 4. Salt Container
- 5. Dispenser
- 6. Cup Shelf
- 7. Spray arms
- 8. Filter assembly
- 9. Inlet pipe connector
- 10. Drain pipe

Model	DWFSG126W	DWFSG126B
Brand	BUSH	BUSH
Colour	White	Black
Capacity	12	12
Energy efficiency class	A++	A++
Drying efficiency class	A	A
Noise level	49 dB(A) re 1 pW	49 dB(A) re 1 pW
Dimension	W598 X D600 X H845mm	W598 X D600 X H845mm

or online at [www.argos-support.co.uk](http://www.argos-support.co.uk) If you still require further assistance, call one of our experts on 0345 257 7271.

# Getting to know your dishwasher

You'll be up and running in no time

## Accessories

- Instructions x 1
- U-bend bracket x 1
- Salt Filler x 1
- Measuring Spoon x 1
- Measuring Cup x 1
- Inlet Hose x 1



## Tools

- Slot head screwdriver x 1
- Scissors x 1
- Pencil x 1
- Steel tape x 1
- Spirit level x 1

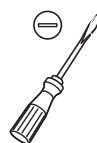

# Installing your dishwasher

3



# Installing your dishwasher

## Bringing it all together

### Unpack the dishwasher

Caution: 2 people are required to unpack and handle the appliance, it is recommended that gloves are worn. Carefully remove all packaging materials including the foam base, dispose of correctly.

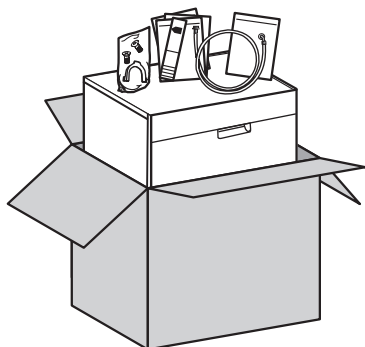

### Position the appliance

1. The dishwasher must be installed on a solid level surface.
2. Position the appliance in the desired location. The back should rest against the wall behind it, and the sides along the adjacent cabinets or wall.

The water supply and drain hoses can be positioned either to the left or right side to facilitate proper installation.

3. To level the dishwasher, adjust the 4 level screws (feet) under the dishwasher.

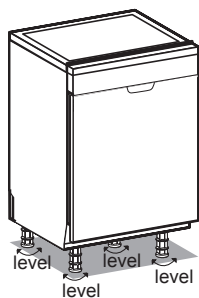

### Water supply connection

Caution: 2 people are required to unpack and handle the appliance, it is recommended that gloves are worn.

- Carefully remove all packaging materials including the foam base, dispose of correctly.
- Connect the cold water supply hose to a threaded  $\frac{3}{4}$ " connector and make sure that it is fastened tightly in place.
- If the water pipes are new or have not been used for an extended period of time, let the water run to make sure that the water is clear. This will prevent the water inlet to be blocked and damage the appliance.

WARNING:

Please close the hydrant after using.

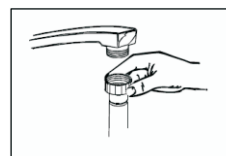

### Drain hose connection

1. Make a hooked end at the end of drain hose with the plastic U-bend bracket (provided). The hooked end should be lower than 100cm from the floor level.
2. The free end of the hose must not be immersed in water to avoid the flow back.
3. You may connect the water inlet hose onto the kitchen sink tap. You must obtain a correct adaptor to match the inlet hose connector for a secure connection. However, permanent plumbing is recommended.
4. If leakage is observed, immediately shut off the water supply and check the hose connections fully. Tighten connections if necessary.

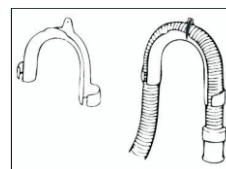

# Installing your dishwasher

Bringing it all together

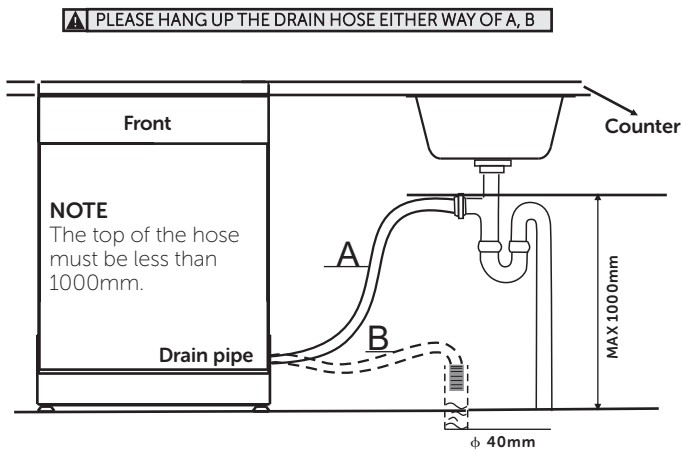

## Water pressure

For best operating results, incoming water pressure should be between 0.04 and 1 Mpa.

Your dishwasher cleans by spraying a mixture of hot clean water and detergent (under pressure) against the soiled surface of dishes. The water is pumped through a rotating spray arm, drained through a filter removing food and soiled particles and pumped back through the spray arm.

**Note:** Hard water conditions will adversely affect the performance of your dishwasher. To minimise this condition, it is recommended to periodically operate/rinse the dishwasher in empty condition using 1 cup of white vinegar (at least once a week).

**Important:** Once you open the water supply (even if it is closed immediately thereafter), the water inlet hose will be pressurised.

## Dimensions

Height:845mm

Width:598mm

Depth:600mm

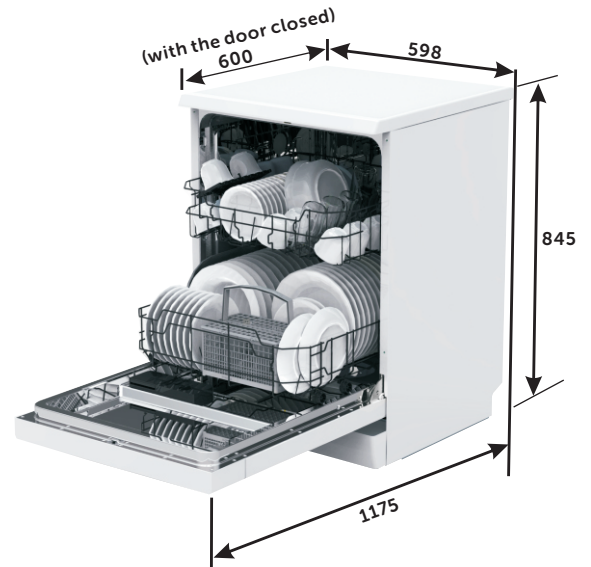



# Installing your dishwasher

## Bringing it all together

**Any electrical work that is required to install this appliance MUST be carried out by a qualified electrician.**

### **Warning: THIS APPLIANCE MUST BE EARTHED**

**Before making any electrical connections, ensure that:**

- Electrical safety is only guaranteed when the earth system of your house is in accordance with the related local regulations.
- Do not bend, stretch or pull the supply cable to avoid electric shock.
- Ensure the power socket is suitable for the maximum power of the appliance (fuses in the power circuit must be 13 amp).
- The supply voltage should be the same as that indicated in the technical specifications and the appliance rating plate.
- The appliance should be earthed and in compliance with the applicable law.
- When installed, the power socket must be within easy reach.
- If the socket outlets in your home are not suitable for the plug supplied with this unit check with a qualified electrician for replacement.
- The use of adapters, multiple connectors or extension cables are not recommended.
- The appliance must be connected to a 220-240 volt 50Hz AC supply by means of a three pin socket, suitably earthed and protected by a 13 amp fuse.
- Should the fuse need to be replaced, a 13 amp fuse approved to BS1362 must be used.
- The plug contains a removable fuse cover that must be refitted when the fuse is replaced. If the fuse cover is lost or damaged, the plug must not be used until a replacement cover has been fitted or the plug is replaced.
- A damaged plug should be cut off as close to the plug body as possible, the fuse should be removed and the plug disposed of safely.

### **Plug replacement (UK & Ireland only)**

Should you need to replace the plug; the wires in the power cable are coloured in the following way:

- Blue - Neutral 'N'
- Brown - Live 'L'
- Green & Yellow - Earth 'E'

As the colours of the wires in the power cable may not correspond with the coloured markings identifying the terminals in your plug, and proceed as follows:

The green & yellow wire must be connected to the terminal in the plug that is marked with the letter E or by the earth symbol.

The blue wire must be connected to the terminal that is marked with the letter N.

The brown wire must be connected to the terminal that is marked with the letter L.

If power supply cord is damaged, it must be replaced by the manufacturer or its service agent or a similar qualified person in order to avoid a hazard.

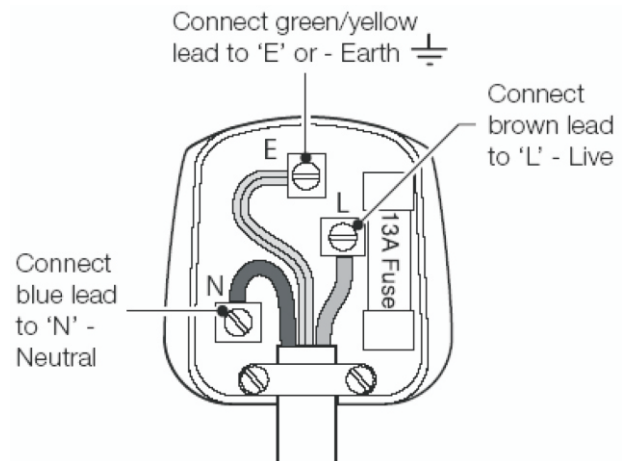

# Functions 4



# Functions Simple everyday use

Getting the most from your appliance

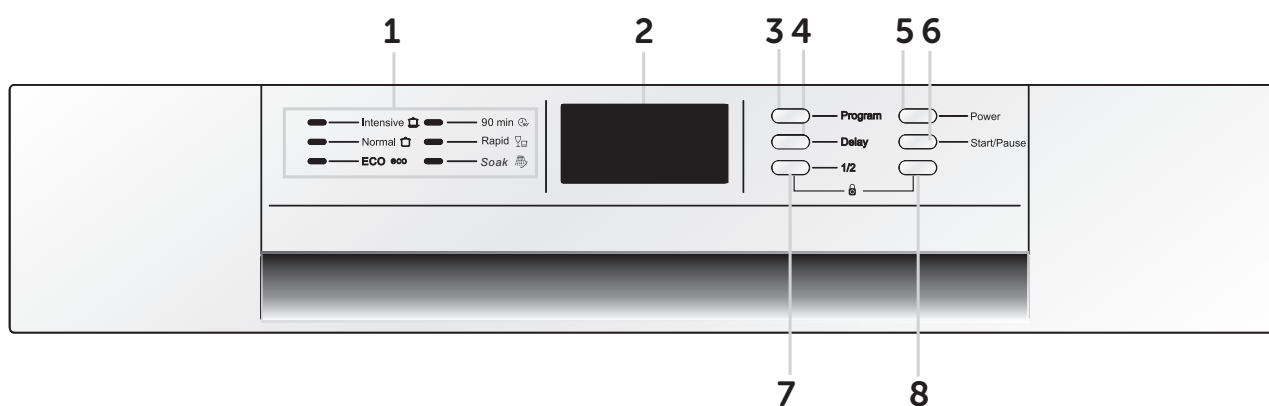

- 1.** Program indicators: To show which program you have chose;
- 2.** Display screen: To show the reminding time and the state(running state, delay time etc )
- 3.** Program Button : To Press the button to select appropriate Program.
- 4.** Delay Button : To Press the button to delay.
- 5.** Power Button: To turn on/off the power supply.

- 6.** Start /Pause button: To start the selected washing program or pause the washing program when the machine is working.
- 7.** Half load functions Button: To select Half load functions. (With this Half load function you can only use it when you have only about or less than 6 place setting dish wave, and you will see less water and energy consumption , can only be used with Intensive, Normal, ECO and 90 min .)
- 8.** Child lock button: Press the Half load and child lock buttons for 3 seconds simultaneously to lock/unlock the program.

If you require any technical guidance or find that your product is not operating as intended, a simple solution can often be found in the **Troubleshooting** section of these instructions,

# Functions Simple everyday use

## Getting the most from your appliance

### To operate the dishwasher:

1. Make sure the water inlet and drain hoses are correctly and securely connected.
2. Push the door release button to open the door.
3. Fill the detergent, water softener and rinsing aid to the dishwasher.
4. Draw out the lower and upper basket. Load the dishes on the dish rack and cutlery inside the cutlery basket. Make sure that the rotating spray arm can turn freely all the way round. If necessary remove any obstacles.
5. Close the door firmly. Open the water supply.
6. Press the ON/OFF button, and the ON/OFF light will turn on. Turn the program selector to select a desired wash cycle, press the Start/Pause button, the machine will work after 10 seconds.
7. The dishwasher is designed to stop if the door is opened accidentally during operation.
8. The dishwasher stops automatically at the end of the program. You will hear 8 sec. buzzer sound. The power pilot light will remain illuminated until the power is switched off.
9. After washing, dishes should be allowed to cool down for about 15 minutes as they are hot to handle. Dishes will cool quicker if the door is opened slightly.
10. Empty the lower basket first and then the upper one. This will avoid water dripping from the upper basket onto the dishes in the lower one.
11. After unloading the dishes, remove and clean the filter and return to its position.

**Note:** This is normal when you noted small amount of water being pumped-out from the drain hose prior to the start of a wash cycle. This is because the pump retains a small amount of water from the previous cycle.

### Program Selection Change

You can modify the washing program at any time. Please check the detergent dispenser. If it is opened, refill with the detergent before start the new program.

Press the Start/Pause button, the dishwasher will be paused, then press the Program button more than 3 seconds to cancel the current program, you can change the program to the desired cycle setting

**Note:** If you open the door during the washing cycle, the machine will pause. When you close the door, the machine will resume operation after 10 seconds.

The Display window shows the state of the dishwasher:

- a) Colour icon in the LED display is on but not blinking ---stand by or pause
- b) Colour icon in the LED display blinking----Running

### Delay function

After selecting the wash cycle program, you can set the desired delay start time by pressing the delay button. You can select 1-24h from the program. The dishwasher will start operation after the selected delay time is elapsed.

Example : Set normal program with 4 hours delay setting.

#### Setting steps

Fill the detergent and salt if necessary  
Put the dishes in and close the door  
Press On/Off button once

Continue to press program button until the indicator light for icon  illuminates.

Continue to press delay button until it displays H:04  
Press start/pause button once to start.

### Child lock function

Lock : In standby state, press Half load and Child lock buttons for 3 seconds, there will be a "beep" denoting entering the child-lock state and the child lock indicator will illuminate.

Unlock : in locked state, press Half load and Child lock buttons for 3 seconds, there will be a "beep" denoting that the lock is released and the child lock indicator will go off.



# Using your dishwasher



# Using your dishwasher

## Getting the most from your appliance

### Before first use

Before using your appliance for the first time:

- Set the water softener
- Add 1.5Kg dishwasher salt and then full fill the salt container with water
- Fill the rinse aid dispenser
- Fill in detergent

### Water Softener

The dishwasher is designed with a softener to eliminate the minerals and lime from the water supply. The hardness of the water supply varies from place to place and will affect the dishwasher performance. The amount of salt consumed can be adjusted based on the hardness of the water used. This is intended to optimise and customize the level of salt consumption.

### Adjusting salt consumption

The dishwasher is designed to allow for adjustment in the amount of salt consumed based on the hardness of the water used. This is intended to optimise and customise the level of salt consumption.

Please follow the steps below for adjustment in salt consumption.

1. Switch on the appliance;
2. Press the Start/Pause button for more than 5 seconds to start the water softener set model within 60 seconds after the appliance was switched on;
3. Press the Start/Pause button to select the proper set according to your local environment, the sets will change in the following sequence: H1->H2->H3->H4->H5->H6;
4. Press the Power button to end the set up model.

WATER HARDNESS				Selector Position	Salt consumption (gram/cycle)
°dH	°fH	°Clarke	mmol/l		
0~5	0~9	0~6	0~0.94	H1	0
6-11	10-20	7-14	1.0-2.0	H2	9
12-17	21-30	15-21	2.1-3.0	H3	12
18-22	31-40	22-28	3.1-4.0	H4	20
23-34	41-60	29-42	4.1-6.0	H5	30
35-55	61-98	43-69	6.1-9.8	H6	60

### Loading the salt into softener

1. Remove the lower basket and then unscrew and remove the cap from the salt container. (Fig 1)

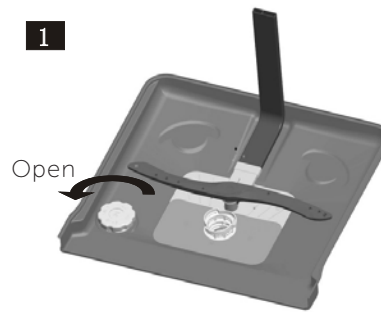

2. Place the end of the funnel (supplied) into the hole and introduce about 1.5kg of dishwasher salt.
3. Full fill the salt container with water. It is normal for a small amount of water to come out of the salt container. (Fig 2)

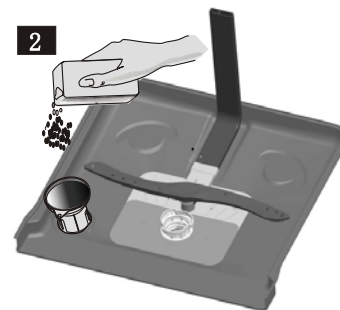

4. Screw the cap tightly back clockwise.
5. Immediately after filling the salt, a washing cycle should be started (soak or rapid program suggested). Otherwise the filter system or pump may be damaged by salty water.

### Important:

- Only use dishwasher salt.
- Add the salt again when the salt warning light at control panel is on.
- It takes time to dissolve the salt so the salt warning light may still come on even the salt container is filled.

# Using your dishwasher

## Getting the most from your appliance

### Rinsing Aid

A rinsing aid is specially formulated to rinse away food and detergent residues that can be left behind on your dishes. Use regularly, a rinse aid will automatically provide you with cleaner dishes every time you wash.

#### Loading the rinsing aid

1. Turn the dispenser cap to 'open' arrow and lift it out.
2. Fill the rinsing aid slowly into the container until it just reaches the bottom of the filling cap
3. Replace the cap by turning to 'close' arrow.



There is a rinse-aid indicator on the dispenser

- Full
- 3/4 Full
- 1/2 Full
- 1/4 Full - Require refill
- Empty - Require refill

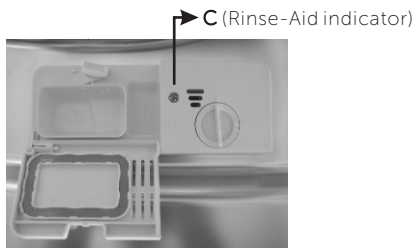

#### Adjusting rinsing aid dispenser

The rinse aid dispenser has six scales. Always start with the dispenser set on "4". If spots and poor drying is a problem, increase the amount of rinse aid dispensed by removing the dispenser lid and rotating the dial to "5". You could adjust the dial to the next higher lever until your dishes are spot-free.

#### Note:

Increase the dose if there are drops of water or lime spots on the dishes after wash. Reduce the dose if there are sticky whitish stains on your dishes or a bluish film on glassware or knife blades.

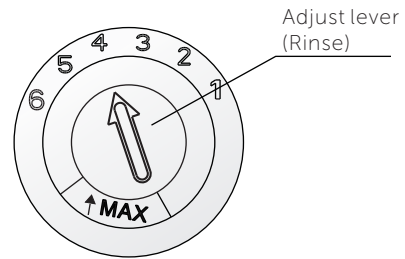

### Detergent

Use only detergent specifically made for use in dishwashers, as other types may damage the dishwasher.

The dispenser must be filled before the start of each wash cycle following the instructions provided in the wash cycle table. Your dishwasher uses less detergent and rinse aid than conventional dishwasher. Generally, only one tablespoon of detergent is sufficient for a normal wash load. Heavily soiled items need more detergent. Always add the detergent just before the start of the dishwasher, otherwise it could get damp and will not dissolve properly.

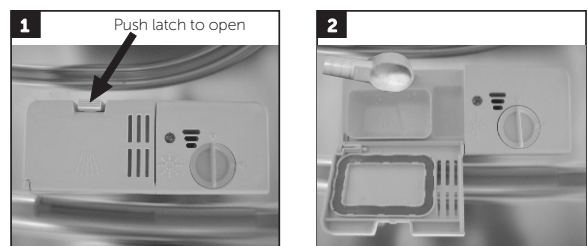

#### Loading the detergent

1. The detergent dispenser (recessed area) located at the inside of the door.
2. Open the lid by pressing the release button.
3. Pour the detergent. The marking indicates the dosing levels:

If you require any technical guidance or find that your product is not operating as intended, a simple solution can often be found in the **Troubleshooting** section of these instructions,



# Using your dishwasher

## Getting the most from your appliance

**A** - Detergent for main wash cycle. 'MIN' means approximately 20g of detergent.

**B** - Detergent for pre-wash cycle, approximately 5g of detergent.

4. Close the lid until it locks in place.

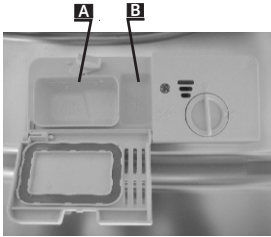

**Note:** follow the detergent manufacturer's guidelines. Dishwasher detergent is corrosive! Keep it out of reach of children.

### Use of "2 in 1", "3 in 1", "4 in 1" and "5 in 1" detergents

These products are detergents with integrated detergent, rinse aid and salt functions. Before using these products you should first check that the water hardness in your supply is compatible with the use of these products as per the detergent manufacturers (packaging). These products should be strictly used according to the detergent manufacturer's instructions. In general detergents that include rinse aid or water softener are only able to serve good results under certain conditions - rinse aid and water softener cannot be adapted to specific conditions. For this reason in some cases there might be unwanted cleaning or drying results. If you encounter problems when using these products please contact the detergent manufacturer's care line. The manufacturer of your dishwasher is not liable for damages caused by compact detergents nor gives warranty if you use compact detergents.

## Loading your dishwasher

### Preparing your dishes prior washing

- Scrape off all food residuals from the dishes.
- Remove excessive quantities of oil or grease.
- Empty any liquids from glasses and cups.
- Dishes with dried-on foods are more difficult to wash and may not come clean in a normal wash cycle.
- Arrange all items with recessed or curved sections on a slant to drain water away.
- Cups, pots and glasses etc should be placed upside down.

### Loading the upper basket

The upper basket is designed to hold more delicate and lighter dishware such as glasses, coffee and tea cup and saucers, plates, small bowls and shallow pans (as long as they are not too dirty). Position the dishes and cookware so that they do not get moved by the spray of water.

1. Cups
2. Saucers
3. Glasses
4. Small serving bowl
5. Medium serving bowl
6. Large serving bowl

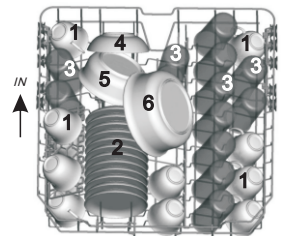

### Adjusting the upper basket

The height of the upper basket can be adjusted in order to create more space for large utensils both for the upper /lower basket. The height of the upper basket can be adjusted by placing the wheels on different heights of the rails. Long items, serving cutlery, salad servers and knives should be placed on the shelf so that they do not obstruct the rotation of the spray arms.

Lower position      Upper position



Wheels

# Using your dishwasher

## Getting the most from your appliance

### Folding back the cup shelves

For better stacking of pots and pans, the spikes can be folded down as show in the picture right.

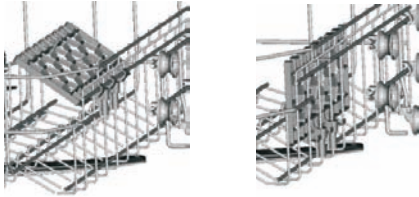

### Folding Spikes of Lower Basket

For better stacking of pots and pans, the spikes can be folded down as show in the picture right.



### Loading the lower basket

- Put large items which are most difficult to clean into the lower basket.
- Locate sharp items so that they are not likely to damage the door seal.
- Load sharp knives with the handles up to reduce the risk of injuries.
- Do not load plastic items unless they are marked "dishwasher safe" or the equivalent.
- Do not load glasses over the dish rack pins. Glasses loaded over dish rack pins are not properly supported and are likely to get damaged.
- Items with wooden or bone handles and items joined together with glue are unsuitable as they cannot resist hot water.

- 7. Dessert dishes
- 8. Dinner plates
- 9. Soup plates
- 10. Oval platter

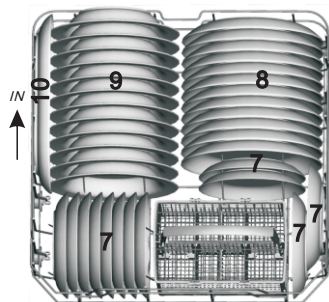

### Cutlery basket

Cutlery should be placed in the cutlery basket with the handles at the bottom. If the rack has side baskets, the spoons should be loaded separately into the appropriate slots, especially long utensils should be placed in horizontal position at the front of the upper basket as shown.

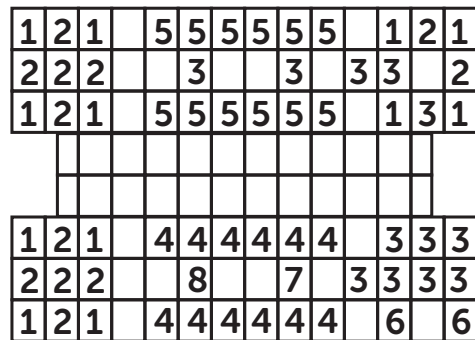

- |                |                   |
|----------------|-------------------|
| 1. Soup spoons | 5. Dessert spoons |
| 2. Forks       | 6. Serving spoons |
| 3. Knives      | 7. Serving forks  |
| 4. Tea spoons  | 8. Gravy ladles   |

**NOTE:** For ease of loading/unloading large size dinner plates from the dish rack it may be necessary to remove the cutlery basket. When loading/unloading is complete, return the cutlery basket to its original position.





### Warning

- Do not touch the heating element during or immediately after use.
- Do not tamper with controls.
- Do not abuse, sit or stand on the open door or dish-rack of the dishwasher. The machine may topple over.
- Protect cables and hoses from high temperatures.
- To reduce the risk of injury, do not allow children to operate or play with the dishwasher.

# Using your dishwasher

Getting the most from your appliance

## Wash cycle table

Program	Cycle Selection Information	Description of Cycle	Detergent pre/main	Running time (min)	Energy (Kwh)	Water (L)	Rinse Aid
Intensive 	For heaviest soiled crockery, and normally soiled pots, pans, dishes etc with dried on soiling.	Prewash (50°C) Wash (60°C) Rinse Rinse Rinse (65°C) Drying	$\frac{5/25g}{(1 \text{ or } 2 \text{ pieces})}$	160	1.5	18.5	★
Normal 	For normally soiled loads, such as pots, plates, glasses and lightly soiled pans.	Prewash(45°C) Wash (55 °C) Rinse Rinse (65 °C) Drying	5/25g	180	1.25	15	★
<b>ECO</b> (*EN 50242)	This is Standard programme, it is suitable to clean normally soiled tableware and it is the most efficient programme in terms of its combined energy and water consumption for that type of tableware.	Prewash Wash (45 °C) Rinse(65°C) Drying	5/25g	185	0.91	11	★
90 Min 	For normally soiled loads that need quick wash.	Wash (65°C) Rinse Rinse (65°C) Drying	25g	90	1.3	12.5	★
Rapid 	A shorter wash for lightly soiled loads that do not need drying.	Wash (45 °C) Rinse Rinse (55 °C)	20g	40	0.75	11.5	
Soak 	To rinse dishes that you plan to wash later that day	Prewash		15	0.02	4	

or online at [www.argos-support.co.uk](http://www.argos-support.co.uk) If you still require further assistance, call one of our experts on **0345 257 7271**.

# Care and maintenance

6



# Care and maintenance

## Looking after your appliance

### General

**Important:** Always unplug the appliance from the power socket during cleaning and maintenance.

- Never use any sharp instruments or abrasive substances, soap, household cleaner, detergent or wax polish for cleaning.
- Clean the external surfaces with a damp soft cloth only. Never use abrasive products or solvents as it may damage the dishwasher.
- One of the factors that cause odour is the food that remains trapped in the seals. Periodic clean the seal with a damp sponge will prevent this from occurring.

The filter system consists of a main filter, coarse filter and fine filter.

- **Main filter (1)** - Food and soil particles trapped in this filter are pulverized by a special jet on the lower spray arm and washed down the drain.
- **Coarse filter (2)** - Larger items such as pieces of bones that could clog the drain are trapped in the coarse filter. To remove an item caught in this filter, gently squeeze the taps on the top of this filter and lift it out.
- **Fine filter (3)** - This filter holds soil and food residues in the sump area and prevents it from being re-deposit on the dishes during a cycle.

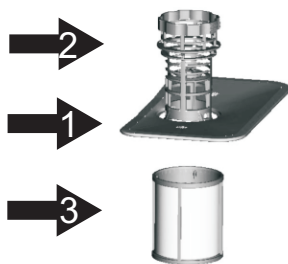

### Cleaning the filter

To clean the coarse filter and the fine filter, use a cleaning brush. Reassemble the filter parts as shown in the figures on the last page and reinsert the entire assembly in the dishwasher, positioning it in its seat and pressing downwards.

### Cleaning the spray arms

It is necessary to clean the spray arms regularly for hard water chemicals will clog the spray arm jets and bearings. To remove the upper spray arm, hold the nut, rotate the arm clockwise to remove it.

To remove the lower spray arm, pull out the spray arm upward.

Wash the arms in soapy and warm water and use a soft brush to clean the jets. Replace them after rinsing them thoroughly.

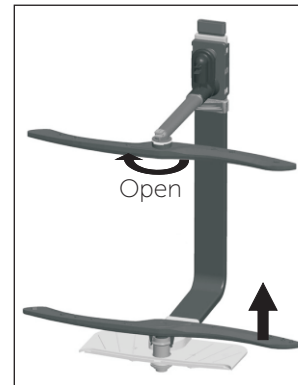

### Not use for long period

If you are not using the dishwasher for a long period of time it is recommended to remove the plug, turn off the water supply and leave the door ajar to prevent odors from forming within the dishwasher.

### Moving the dishwasher

If you need to move the dishwasher, try to keep it in vertical position. Avoid over tilting during the transportation.

**Product support**

7



# Product support

Help is always at hand

## Troubleshooting

In the unlikely event of difficulties with your appliance please follow the trouble shooting guide below. If the problem persists, contact the retailer if the machine is still under guarantee. If the machine is out of guarantee, contact an approved service agent on **0345 257 7271**

### If dishwasher won't start?

- Insert the mains plug.
- Close the door.
- Turn on the water supply.

### If dishwasher won't load water?

- Check the water pressure.
- Ensure the hose is not crimped or bent.
- Clean the filter.

### If dishes won't clean?

- Arrange dishes so spray action reaches all surfaces.
- Do not overload the dishwasher.
- Make sure nothing (i.e. cutlery) is obstructing spray arm rotation.
- Use proper dishwasher detergent.
- Remove excessive food and liquids from dishes before loading.

### If dishwasher won't drain?

- Ensure the hose is not crimped or bent.

### If there is much noise?

- Interrupt the program and re-arrange the items which are obstructing the spray arm.
- Interrupt the program and re-arrange the items of crockery.

### If there is not satisfactory drying result?

- Load as suggested in instructions. Increase the rinse aid amount or refill the rinse aid dispenser.
- Do not empty the dishwasher immediately after wash.
- Washing temperature is lower in short program.
- Choose a program with a long washing time.

Error codes	Description	Possible causes
E1	Longer inlet time	Faucet is not opened, water intake is restricted or water pressure is too low.
E4	Overflow	Some element of dishwasher leaks.

### Warning:

- If overflow occurs, turn off the water supply before contacting the customer helpline.
- If there is water in the base pan because of overfill or small leak, the water should be removed before restarting the dishwasher.

If you require any technical guidance or find that your product is not operating as intended, a simple solution can often be found in the **Troubleshooting** section of these instructions,

# Product support

Help is always at hand

## Technical specifications (according to EU Directive 1059/2010)

Brand	BUSH
Model	DWFSG126W,DWFSG126B
Capacity	12 settings
Energy efficiency class <b>1</b>	A++
Annual energy consumption <b>2</b>	258 kWh
Energy consumption of the standard cleaning cycle	0.91 kWh
Power consumption of off-mode / left-on mode	0.45 W /0.49 W
Annual water consumption <b>3</b>	3080 litre
Drying efficiency class <b>4</b>	A
Standard cleaning cycle <b>5</b>	ECO 45°C
Program time for the standard cleaning cycle	185 min
Noise level	49 dB(A ) re 1 pW
Free standing / Built-in	Free standing
Dimension	W598 X D600 X H845mm
Power consumption	1760-2100 W
Rated voltage	220 -240 V~ 50 Hz
Water pressure (flow pressure)	0.04-1 MP a

### NOTE:

- 1** A + + + (most efficiency) to D (least efficiency)
  - 2** Energy consumption "258" kWh per year, based on 280 standard cleaning cycles using cold water fill and the consumption of the low power modes. Actual energy consumption will depend on how the appliance is used.
  - 3** Water consumption "3080" litres per year, based on 280 standard cleaning cycles. Actual water consumption will depend on how the appliance is used.
  - 4** A (most efficiency) to G (least efficiency)
  - 5** This program is suitable for cleaning normally soiled tableware, and that it is the most efficient programme in terms of its combined energy and water consumption for that type of tableware.
- The above values have been measured in accordance with standards under specified operating conditions. Results may vary greatly according to quantity and pollution of the dishes, water hardness, amount of detergent, etc.

We apologise for any inconvenience caused by any minor inconsistencies in these instructions, which may occur as a result of product improvements and development.



# Product support

Help is always at hand

## Help and assistance

If you require any technical guidance or find that your dishwasher is not operating as intended, a simple solution can often be found in the **Troubleshooting** section of these instructions or online at [www.argos-support.co.uk](http://www.argos-support.co.uk)

If you still require further assistance, call one of our experts on **0345 257 7271**. To help give us give you a fast and efficient service please have the following information ready:

Model Ref.	<input type="text"/>	You can find these on the rating plate - a small information panel (usually a sticker or metal plate) on the rear of your appliance
Serial number	<input type="text"/>	
Date of purchase	<input type="text"/>	This will be shown on your receipt

Local call rates applies\*

Lines open 8am-7pm Monday to Saturday and 10am-4pm Sunday.

\*Calls to Argos enquiry lines may attract a charge and set up fee from residential lines depending on your call plan/tariff. Mobile and other providers costs may vary, see [www.bt.com/pricing](http://www.bt.com/pricing) for details.

For Security and training purposes, telephone calls to and from customer service centres maybe recorded and monitored. Calls from Republic of Ireland will attract international call charges.

or online at [www.argos-support.co.uk](http://www.argos-support.co.uk) If you still require further assistance, call one of our experts on **0345 257 7271**.

# Product support

Help is always at hand



This appliance complies with the following EEC directives:

2006/95/EEC Low voltage directive

2004/108/EEC EMC directive

2009/125/EC ERP directive

## Disposal information



The symbol on the product or its packaging indicates that this product may not be treated as household waste. Instead it should be handed over to the applicable collection point for the recycling of electrical and electronic equipment. By ensuring this product is disposed of correctly, you will help prevent potential negative consequences for the environment and human health, which could otherwise be caused by inappropriate waste handling of this product. For more detailed information about recycling this product, please contact your local council office, your household waste disposal service or the shop where the product was purchased.

## Product support

Help is always at hand

# BUSH

### Call us now and activate your 12 month guarantee

Thank you for choosing Bush. Your new product is guaranteed against faults and breakdowns for 12 months. Don't forget to register it with us today so we can provide you with our best possible after-sales service and useful updates.

**[www.bushregistration.co.uk](http://www.bushregistration.co.uk)**

FREEPHONE\*

**0800 597 8548**

Lines are open 8am - 8pm, 365 days a year. \*Calls may be recorded and monitored.

### Your Bush Guarantee

This product is guaranteed for twelve months from the date of original purchase. Any defect that arises due to faulty materials or workmanship will be repaired free of charge (or if applicable the product will be replaced or the purchase price refunded) where possible during this period by the dealer from who your purchased the unit.

The guarantee is subject to the following provisions:

- The guarantee does not cover accidental damage, misuse, cabinet parts, knobs or consumable items.
- The product must be correctly installed and operated in accordance with the instructions contained in the manual.
- It must be used solely for domestic purposes. The guarantee will be rendered invalid if the product is re-sold or has been damaged by inexpert repair.
- Specifications are subject to change without notice.
- Bush disclaim any liability for loss or damage arising from the breakdown of the product.
- This guarantee is in addition to and does not diminish your statutory or legal rights.

### Important Data Protection Information

If you provide us with information about another person, you confirm that they have appointed you to act for them, to consent to the processing of their personal data including sensitive personal data and that you have informed them of our identity and the purposes (as set out in the Important Data Privacy notice displayed overleaf) for which their personal data will be processed.

You are entitled to ask for a copy of the information we hold about you (for which we may charge a small fee) and to have any inaccuracies in your information corrected.

For quality control and training purposes, we may monitor or record your communications with us.

If your personal details change, if you change your mind about any of your marketing preferences or if you have any queries about how we use your information, please let us know by contacting our Data Protection Officer, Domestic & General, Leicester House 17 Leicester Street, Bedworth, Warwickshire CV12 8JP.

Guarantor: Argos Limited - 489 - 499 Avebury Blvd. - Milton Keynes - MK9 2NW

or online at [www.argos-support.co.uk](http://www.argos-support.co.uk) If you still require further assistance, call one of our experts on **0345 257 7271**.



# BUSH

**Contact:**

[www.argos-support.co.uk](http://www.argos-support.co.uk)

Helpline: 0345 257 7271