



PowerShot SX420 IS Camera User Guide

ENGLISH

- Make sure you read this guide, including the “Safety Precautions” (11) section, before using the camera.
- Reading this guide will help you learn to use the camera properly.
- Store this guide safely so that you can use it in the future.

- Click the buttons in the lower right to access other pages.
 -  : Next page
 -  : Previous page
 -  : Page before you clicked a link
- To jump to the beginning of a chapter, click the chapter title at right.

Before Use

Basic Guide

Advanced Guide

1 Camera Basics

2 Auto Mode

3 Other Shooting Modes

4 P Mode

5 Playback Mode

6 Wi-Fi Functions

7 Setting Menu

8 Accessories

9 Appendix

Index

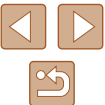

Before Use

Initial Information

Package Contents

Before use, make sure the following items are included in the package. If anything is missing, contact your camera retailer.



Camera



Battery Pack
NB-11LH*



Battery Charger
CB-2LF/CB-2LFE



Wrist Strap



Lens Cap
(with cord)

* Do not peel off the adhesive covering from a battery pack.

- Printed matter is also included.
- A memory card is not included (📖2).

Compatible Memory Cards

The following memory cards (commercially available) can be used, regardless of capacity.

- SD memory cards*
- SDHC memory cards*
- SDXC memory cards*



* Cards conforming to SD standards. However, not all memory cards have been verified to work with the camera.

Before Use

Basic Guide

Advanced Guide

1 Camera Basics

2 Auto Mode

3 Other Shooting Modes

4 P Mode

5 Playback Mode

6 Wi-Fi Functions

7 Setting Menu

8 Accessories

9 Appendix

Index



Preliminary Notes and Legal Information

- Take and review some test shots initially to make sure the images were recorded correctly. Please note that Canon Inc., its subsidiaries and affiliates, and its distributors are not liable for any consequential damages arising from any malfunction of a camera or accessory, including memory cards, that result in the failure of an image to be recorded or to be recorded in a way that is machine readable.
- The user's unauthorized photographing or recording (video and/or sound) of people or copyrighted materials may invade the privacy of such people and/or may violate others' legal rights, including copyright and other intellectual property rights, even when such photographing or recording is intended solely for personal use.
- For information on camera warranty or Canon Customer Support, please refer to the warranty information provided with your camera User Manual Kit.
- Although the screen is produced under extremely high-precision manufacturing conditions and more than 99.99% of the pixels meet design specifications, in rare cases some pixels may be defective or may appear as red or black dots. This does not indicate damage. This does not affect recorded images either.
- When the camera is used over an extended period, it may become warm. This does not indicate damage.

Conventions in This Guide

- In this guide, icons are used to represent the corresponding camera buttons on which they appear, or which they resemble.
- The following camera buttons and controls are represented by icons. Also, the numbers in parenthesis indicates the numbers of the buttons and controls on "Part Names" (📖4).
 - [▲] Up button (9) on back
 - [◀] Left button (13) on back
 - [▶] Right button (11) on back
 - [▼] Down button (12) on back
- Shooting modes and on-screen icons and text are indicated in brackets.
- ⓘ: Important information you should know.
- 📌: Notes and tips for expert camera use.
- 📖xx: Pages with related information (in this example, "xx" represents a page number).
- The symbols "▶ **Still Images**" and "▶ **Movies**" below titles indicate how the function is used—whether for still images or movies.
- Instructions in this guide apply to the camera under default settings.
- For convenience, all supported memory cards are simply referred to as the "memory card".

Before Use

Basic Guide

Advanced Guide

1 Camera Basics

2 Auto Mode

3 Other Shooting Modes

4 P Mode

5 Playback Mode

6 Wi-Fi Functions

7 Setting Menu

8 Accessories

9 Appendix

Index

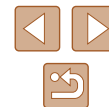

Part Names

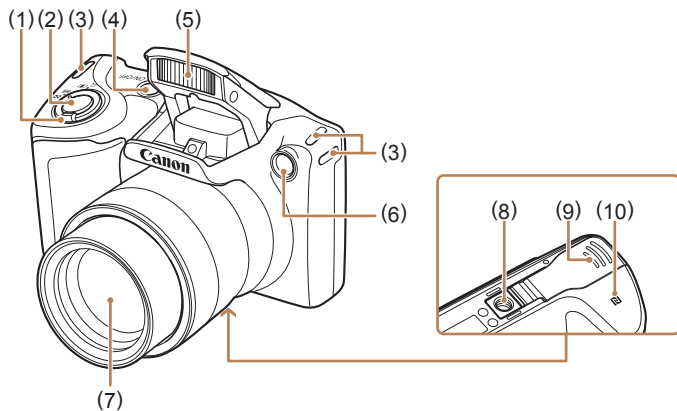

- | | |
|--|-------------------------------|
| (1) Zoom lever | (5) Flash |
| Shoot Only: [T] (telephoto) / [W] (wide angle) | (6) Lamp |
| Playback: [Q] (magnify) / [i] (index) | (7) Lens |
| (2) Shutter button | (8) Tripod socket |
| (3) Strap mount | (9) Memory card/battery cover |
| (4) ON/OFF button | (10) [N] (N-Mark)* |

* Used with NFC feature (p.79).

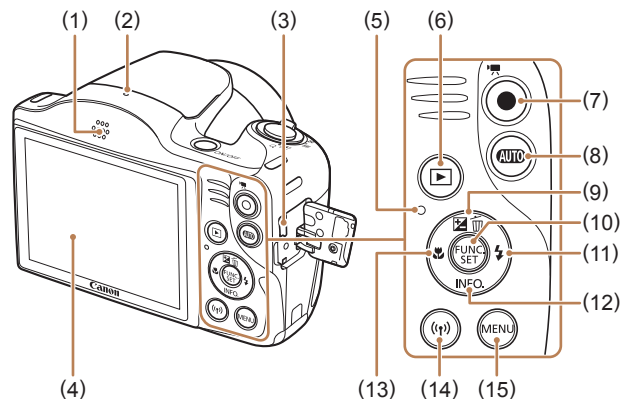

- | | |
|--|--|
| (1) Speaker | (9) [±] (Exposure compensation) / [Erase] (Single-image erase) / Up button |
| (2) Microphone | (10) FUNC./SET (Function/Set) button |
| (3) AV OUT (Audio/video output) / DIGITAL terminal | (11) [Flash] / Right button |
| (4) Screen (Monitor) | (12) [INFO.] (Information) / Down button |
| (5) Indicator | (13) [Macro] / Left button |
| (6) [▶] (Playback) button | (14) [Wi-Fi] button |
| (7) Movie button | (15) [MENU] (Menu) button |
| (8) [AUTO] (Auto) button | |

Before Use

Basic Guide

Advanced Guide

1 Camera Basics

2 Auto Mode

3 Other Shooting Modes

4 P Mode

5 Playback Mode

6 Wi-Fi Functions

7 Setting Menu

8 Accessories

9 Appendix

Index



Table of Contents

Before Use

Initial Information	2
Package Contents	2
Compatible Memory Cards	2
Preliminary Notes and Legal Information	3
Conventions in This Guide	3
Part Names	4
Common Camera Operations	10
Safety Precautions	11

Basic Guide

Basic Operations	14
Initial Preparations	14
Attaching Accessories	14
Holding the Camera	15
Charging the Battery Pack	15
Inserting the Battery Pack and Your Memory Card (Commercially Available)	16
Removing the Battery Pack and Memory Card	16
Setting the Date and Time	17
Changing the Date and Time	17
Display Language	18
Trying the Camera Out	19
Shooting (Smart Auto)	19
Viewing	20
Erasing Images	21

Advanced Guide

1 Camera Basics	22
On/Off	22
Power-Saving Features (Auto Power Down)	23
Power Saving in Shooting Mode	23
Power Saving in Playback Mode	23
Shutter Button	23
Shooting Display Options	24
Using the FUNC. Menu	24
Using the Menu Screen	25
On-Screen Keyboard	26
Indicator Display	27
Clock	27
2 Auto Mode	28
Shooting with Camera-Determined Settings	28
Shooting (Smart Auto)	28
Still Images/Movies	30
Still Images	30
Movies	31
Scene Icons	31
Image Stabilization Icons	32
On-Screen Frames	33
Common, Convenient Features	33
Zooming In Closer on Subjects (Digital Zoom)	33
Using the Self-Timer	34
Using the Self-Timer to Avoid Camera Shake	34
Customizing the Self-Timer	35
Adding a Date Stamp	35
Continuous Shooting	36
Image Customization Features	37

Before Use
Basic Guide
Advanced Guide
1 Camera Basics
2 Auto Mode
3 Other Shooting Modes
4 P Mode
5 Playback Mode
6 Wi-Fi Functions
7 Setting Menu
8 Accessories
9 Appendix
Index



Changing the Aspect Ratio	37
Changing Image Resolution (Size).....	37
Guidelines for Choosing Resolution Based on Paper Size (for 4:3 Images)	37
Changing Movie Image Quality	38
Helpful Shooting Features.....	38
Displaying Grid Lines.....	38
Magnifying the Area in Focus	39
Customizing Camera Operation	39
Deactivating the AF-Assist Beam	39
Deactivating the Red-Eye Reduction Lamp.....	40
Changing the Image Display Style after Shots	40
Changing the Image Display Period after Shots	40
Changing the Screen Displayed after Shots	41
3 Other Shooting Modes	42
Brightness / Color Customization (Live View Control).....	42
Specific Scenes.....	43
Applying Special Effects.....	44
Shooting with a Fish-Eye Lens Effect (Fish-Eye Effect)	44
Shots Resembling Miniature Models (Miniature Effect).....	45
Playback Speed and Estimated Playback Time (for One- Minute Clips).....	45
Shooting with a Toy Camera Effect (Toy Camera Effect).....	46
Shooting in Monochrome.....	46
Special Modes for Other Purposes	47
Using the Face Self-Timer	47
Shooting Long Exposures (Long Shutter)	47
4 P Mode.....	49
Shooting in Program AE ([P] Mode).....	49
Image Brightness (Exposure).....	50
Adjusting Image Brightness (Exposure Compensation).....	50

Changing the Metering Method	50
Changing the ISO Speed.....	51
Correcting Image Brightness (i-Contrast).....	51
Image Colors	52
Adjusting White Balance.....	52
Custom White Balance.....	52
Changing Image Color Tones (My Colors)	52
Custom Color.....	53
Shooting Range and Focusing	54
Shooting Close-Ups (Macro)	54
Shooting Distant Subjects (Infinity).....	54
Digital Tele-Converter	54
Changing the AF Frame Mode	55
Center.....	55
Face AiAF	56
Choosing Subjects to Focus On (Tracking AF)	56
Shooting with Servo AF	57
Changing the Focus Setting	57
Flash.....	58
Changing the Flash Mode	58
Auto	58
On.....	58
Slow Synchro	58
Off.....	58
Other Settings	59
Changing the Compression Ratio (Image Quality).....	59
Changing the IS Mode Settings.....	59
Shooting Movies with Subjects at the Same Size Shown before Shooting	60
5 Playback Mode	61
Viewing.....	61

Before Use
Basic Guide
Advanced Guide
1 Camera Basics
2 Auto Mode
3 Other Shooting Modes
4 P Mode
5 Playback Mode
6 Wi-Fi Functions
7 Setting Menu
8 Accessories
9 Appendix
Index

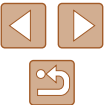

Switching Display Modes.....	63
Overexposure Warning (for Image Highlights)	63
Histogram	63
GPS Information Display	63
Browsing and Filtering Images	64
Navigating through Images in an Index	64
Finding Images Matching Specified Conditions.....	64
Image Viewing Options	65
Magnifying Images	65
Viewing Slideshows.....	66
Changing Slideshow Settings.....	66
Auto Playback of Related Images (Smart Shuffle).....	66
Protecting Images	67
Using the Menu	68
Choosing Images Individually.....	68
Selecting a Range	68
Protecting All Images at Once	69
Clearing All Protection at Once	69
Erasing Images	70
Erasing Multiple Images at Once.....	70
Choosing a Selection Method	70
Choosing Images Individually.....	70
Selecting a Range	71
Specifying All Images at Once.....	71
Rotating Images	71
Using the Menu	71
Deactivating Auto Rotation	72
Tagging Images as Favorites	72
Using the Menu	72
Editing Still Images.....	73
Resizing Images.....	73
Cropping.....	74

Changing Image Color Tones (My Colors)	75
Correcting Image Brightness (i-Contrast).....	75
Correcting Red-Eye.....	76
Editing Movies.....	77
6 Wi-Fi Functions.....	78
Available Wi-Fi Features	78
Sending Images to a Smartphone.....	79
Sending Images to an NFC-Compatible Smartphone	79
Connecting via NFC When Camera Is Off or in Shooting Mode	79
Connecting via NFC When Camera Is in Playback Mode.....	81
Adding a Smartphone.....	82
Using Another Access Point	84
Previous Access Points	84
Saving Images to a Computer.....	85
Preparing to Register a Computer.....	85
Installing the Software	85
Configuring the Computer for a Wi-Fi Connection (Windows Only).....	85
Saving Images to a Connected Computer.....	86
Confirming Access Point Compatibility	86
Using WPS-Compatible Access Points	87
Connecting to Listed Access Points	89
Previous Access Points	90
Sending Images to a Registered Web Service.....	90
Registering Web Services	90
Registering CANON iIMAGE GATEWAY.....	91
Registering Other Web Services	92
Uploading Images to Web Services	93
Printing Images Wirelessly from a Connected Printer.....	94
Sending Images to Another Camera	95

Before Use
Basic Guide
Advanced Guide
1 Camera Basics
2 Auto Mode
3 Other Shooting Modes
4 P Mode
5 Playback Mode
6 Wi-Fi Functions
7 Setting Menu
8 Accessories
9 Appendix
Index



Image Sending Options.....	97
Sending Multiple Images.....	97
Selecting a Range.....	97
Sending Images Tagged as Favorites.....	97
Notes on Sending Images.....	98
Choosing the Number of Recording Pixels (Image Size).....	98
Adding Comments.....	99
Sending Images Automatically (Image Sync).....	99
Initial Preparations.....	99
Preparing the Camera.....	99
Preparing the Computer.....	100
Sending Images.....	100
Viewing Images Sent via Image Sync on Your Smartphone.....	101
Using a Smartphone to View Camera Images and Control the Camera.....	102
Geotagging Images on the Camera.....	102
Shooting Remotely.....	102
Editing or Erasing Wi-Fi Settings.....	103
Editing Connection Information.....	103
Changing a Device Nickname.....	104
Erasing Connection Information.....	104
Changing the Camera Nickname.....	104
Returning the Wi-Fi Settings to Default.....	105
7 Setting Menu.....	106
Adjusting Basic Camera Functions.....	106
Silencing Camera Operations.....	106
Adjusting the Volume.....	106
Hiding Hints and Tips.....	107
Date and Time.....	107
World Clock.....	107
Lens Retraction Timing.....	108

Using Eco Mode.....	108
Power-Saving Adjustment.....	108
Screen Brightness.....	109
Hiding the Start-Up Screen.....	109
Formatting Memory Cards.....	109
Low-Level Formatting.....	110
File Numbering.....	110
Date-Based Image Storage.....	111
Metric / Non-Metric Display.....	111
Checking Certification Logos.....	111
Display Language.....	111
Adjusting Other Settings.....	111
Restoring Defaults.....	112
8 Accessories.....	113
System Map.....	113
Optional Accessories.....	114
Power Supplies.....	114
Flash Unit.....	115
Other Accessories.....	115
Printer.....	115
Photo Storage.....	115
Using Optional Accessories.....	116
Playback on a TV.....	116
Using the Software.....	117
Connect to a Computer Using a Cable.....	117
Checking Your Computer Environment.....	117
Installing the Software.....	117
Saving Images to a Computer.....	117
Printing Images.....	119
Easy Print.....	119
Configuring Print Settings.....	120

Before Use
Basic Guide
Advanced Guide
1 Camera Basics
2 Auto Mode
3 Other Shooting Modes
4 P Mode
5 Playback Mode
6 Wi-Fi Functions
7 Setting Menu
8 Accessories
9 Appendix
Index

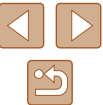

Cropping Images before Printing.....	120
Choosing Paper Size and Layout before Printing	121
Available Layout Options.....	121
Printing ID Photos	121
Printing Movie Scenes.....	122
Movie Printing Options	122
Adding Images to the Print List (DPOF).....	123
Configuring Print Settings.....	123
Setting Up Printing for Individual Images	123
Setting Up Printing for a Range of Images.....	124
Setting Up Printing for All Images.....	124
Clearing All Images from the Print List	124
Printing Images Added to the Print List (DPOF).....	124
Adding Images to a Photobook	125
Choosing a Selection Method	125
Adding Images Individually.....	125
Adding All Images to a Photobook	125
Removing All Images from a Photobook	125
9 Appendix	126
Troubleshooting.....	126
On-Screen Messages.....	130
On-Screen Information.....	132
Shooting (Information Display).....	132
Battery Level	132
Playback (Detailed Information Display).....	133
Summary of Movie Control Panel.....	133
Functions and Menu Tables	134
Functions Available in Each Shooting Mode	134
FUNC. Menu.....	135
Shooting Tab.....	137
Set Up Tab.....	139
Playback Tab	139

Print Tab	140
Playback Mode FUNC. Menu.....	140
Handling Precautions	140
Specifications	141
Camera.....	141
Number of Shots/Recording Time, Playback Time	142
Shooting Range.....	142
Number of Shots per Memory Card	143
Recording Time per Memory Card	143
Battery Pack NB-11LH.....	144
Battery Charger CB-2LF/CB-2LFE.....	144
Index.....	145
Wi-Fi (Wireless LAN) Precautions.....	147
Radio Wave Interference Precautions.....	147
Security Precautions.....	147
Trademarks and Licensing	148
Disclaimer.....	149

Before Use
Basic Guide
Advanced Guide
1 Camera Basics
2 Auto Mode
3 Other Shooting Modes
4 P Mode
5 Playback Mode
6 Wi-Fi Functions
7 Setting Menu
8 Accessories
9 Appendix
Index

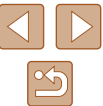

Common Camera Operations

Shoot

- Use camera-determined settings (Auto Mode)
 - 428

Shooting people well



Portraits
(43)

Matching specific scenes



Low Light
(43)



Fireworks
(43)

Applying special effects



Vivid Colors
(44)



Poster Effect
(44)



Fish-Eye Effect
(44)



Miniature Effect
(45)



Toy Camera Effect
(46)



Monochrome
(46)

- While adjusting image settings (Live View Control)
 - 42
- Focus on faces
 - 28, 43, 56
- Without using the flash (Flash Off)
 - 28
- Include yourself in the shot (Self-Timer)
 - 34, 47
- Add a date stamp
 - 35

View

- View images (Playback Mode)
 - 61
- Automatic playback (Slideshow)
 - 66
- On a TV
 - 116
- On a computer
 - 117
- Browse through images quickly
 - 64
- Erase images
 - 70

Before Use

Basic Guide

Advanced Guide

1 Camera Basics

2 Auto Mode

3 Other Shooting Modes

4 P Mode

5 Playback Mode

6 Wi-Fi Functions

7 Setting Menu



8 Accessories

9 Appendix

Index



Shoot/View Movies

- Shoot movies
 -  28
- View movies (Playback Mode)
 -  61



Print

- Print pictures
 -  119

Save

- Save images to a computer
 -  117

Use Wi-Fi Functions

- Send images to a smartphone
 -  79
- Share images online
 -  90
- Send images to a computer
 -  85

Safety Precautions

- Before using the product, ensure that you read the safety precautions described below. Always ensure that the product is used correctly.
- The safety precautions noted here are intended to prevent you and other persons from being injured or incurring property damage.
- Be sure to also check the guides included with any separately sold accessories you use.



Warning

Denotes the possibility of serious injury or death.

- Do not trigger the flash in close proximity to people's eyes. This could damage your eyesight. In particular, remain at least 1 meter (3.3 feet) away from infants when using the flash.
- Store this equipment out of the reach of children and infants. A strap wound around a child's neck may result in asphyxiation. If your product uses a power cord, mistakenly winding the cord around a child's neck may result in asphyxiation.
- Use only recommended power sources.
- Do not disassemble, alter, or apply heat to the product.
- Do not peel off the adhesive covering, if the battery pack has it.
- Avoid dropping or subjecting the product to severe impacts.
- Do not touch the interior of the product if it is broken, such as when dropped.
- Stop using the product immediately if it emits smoke or a strange smell, or otherwise behaves abnormally.
- Do not use organic solvents such as alcohol, benzene, or thinner to clean the product.

Before Use

Basic Guide

Advanced Guide

1 Camera Basics

2 Auto Mode

3 Other Shooting Modes

4 P Mode

5 Playback Mode

6 Wi-Fi Functions

7 Setting Menu

8 Accessories

9 Appendix

Index



- Avoid contact with liquid, and do not allow liquid or foreign objects inside.

This could result in electrical shock or fire.

If the product gets wet, or if liquid or foreign objects get inside, remove the battery pack/batteries or unplug immediately.

- Do not look through the viewfinder or the lens (if your model has a viewfinder or interchangeable lens) at intense light sources such as the sun on a clear day or an intense artificial light source.

This could damage your eyesight.

- When using products with interchangeable lenses, do not leave the camera with a lens attached or a lens itself out in direct sunlight without the lens cap on.

This may cause a fire to start.

- Do not touch the product during thunderstorms if it is plugged in. This could result in electrical shock or fire. Immediately stop using the product and distance yourself from it.

- Use only the recommended battery pack/batteries.

- Do not place the battery pack/batteries near or in direct flame.

This may cause the battery pack/batteries to explode or leak, resulting in electrical shock, fire, or injuries. If leaking battery electrolyte comes into contact with eyes, mouth, skin, or clothing, immediately flush with water.

- If the product uses a battery charger, note the following precautions.
 - Remove the plug periodically and, using a dry cloth, wipe away any dust and dirt that has collected on the plug, the exterior of the power outlet, and the surrounding area.
 - Do not insert or remove the plug with wet hands.
 - Do not use the equipment in a manner that exceeds the rated capacity of the electrical outlet or wiring accessories. Do not use if the plug is damaged or not fully inserted in the outlet.
 - Do not allow dust or metal objects (such as pins or keys) to contact the terminals or plug.
 - Do not cut, damage, alter, or place heavy items on the power cord, if your product uses one.

This could result in electrical shock or fire.

- Turn the camera off in places where camera use is prohibited. The electromagnetic waves emitted by the camera may interfere with the operation of electronic instruments and other devices. Exercise adequate caution when using the product in places where use of electronic devices is restricted, such as inside airplanes and medical facilities.

- Do not allow the camera to maintain contact with skin for extended periods.

Even if the camera does not feel hot, this may cause low-temperature burns, manifested in redness of the skin or blistering. Use a tripod in hot places, or if you have poor circulation or insensitive skin.

	Caution	Denotes the possibility of injury.
--	----------------	------------------------------------

- When carrying the product by the strap, be careful not to bang it, subject it to strong impacts or shocks, or let it get caught on other objects.

- Be careful not to bump or push strongly on the lens. This could lead to injury or damage the camera.

- Be careful not to subject the screen to strong impacts. If the screen cracks, injury may result from the broken fragments.

- When using the flash, be careful not to cover it with your fingers or clothing. This could result in burns or damage to the flash.

- Avoid using, placing, or storing the product in the following places:
 - Places subject to direct sunlight
 - Places subject to temperatures above 40 °C (104 °F)
 - Humid or dusty places

These could cause leakage, overheating, or an explosion of the battery pack/batteries, resulting in electrical shock, fire, burns, or other injuries. Overheating and damage may result in electrical shock, fire, burns, or other injuries.

Before Use
Basic Guide
Advanced Guide
1 Camera Basics
2 Auto Mode
3 Other Shooting Modes
4 P Mode
5 Playback Mode
6 Wi-Fi Functions
7 Setting Menu
8 Accessories
9 Appendix
Index



- The slideshow transition effects may cause discomfort when viewed for prolonged periods.
- When using optional lenses, lens filters, or filter adapters (if applicable), be sure to attach these accessories firmly.

If the lens accessory becomes loose and falls off, it may crack, and the shards of glass may lead to cuts.

- On products that raise and lower the flash automatically, make sure to avoid pinching your fingers with the lowering flash. This could result in injury.

Caution

Denotes the possibility of property damage.

- Do not aim the camera at intense light sources, such as the sun on a clear day or an intense artificial light source. Doing so may damage the image sensor or other internal components.

- When using the camera on a sandy beach or at a windy location, be careful not to allow dust or sand to enter the camera.

- On products that raise and lower the flash automatically, do not push the flash down or pry it open. This may cause the product to malfunction.

- Wipe off any dust, grime, or other foreign matter on the flash with a cotton swab or cloth. The heat emitted from the flash may cause foreign matter to smoke or the product to malfunction.

- Remove and store the battery pack/batteries when you are not using the product. Any battery leakage that occurs may cause product damage.

- Before you discard the battery pack/batteries, cover the terminals with tape or other insulators. Contacting other metal materials may lead to fire or explosions.

- Unplug any battery charger used with the product when not in use. Do not cover with a cloth or other objects when in use. Leaving the unit plugged in for a long period of time may cause it to overheat and distort, resulting in fire.

- Do not leave any dedicated battery packs near pets. Pets biting the battery pack could cause leakage, overheating, or explosion, resulting in product damage or fire.

- If your product uses multiple batteries, do not use batteries that have different levels of charge together, and do not use old and new batteries together. Do not insert the batteries with the + and – terminals reversed.

This may cause the product to malfunction.

- Do not sit down with the camera in your pant pocket. Doing so may cause malfunctions or damage the screen.

- When putting the camera in your bag, ensure that hard objects do not come into contact with the screen. Also close the screen (so that it faces the body), if your product's screen closes.

- Do not attach any hard objects to the product. Doing so may cause malfunctions or damage the screen.



Before Use

Basic Guide

Advanced Guide

1 Camera Basics

2 Auto Mode

3 Other Shooting Modes

4 P Mode

5 Playback Mode

6 Wi-Fi Functions

7 Setting Menu

8 Accessories

9 Appendix

Index

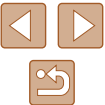

Basic Guide

Basic Operations

Basic information and instructions, from initial preparations to shooting and playback

Initial Preparations

Prepare for shooting as follows.

Attaching Accessories

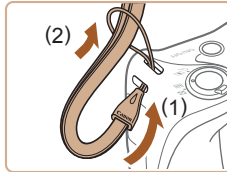

1 Attach the strap.

- Thread the end of the strap through the strap mount (1), and then pull the other end of the strap through the loop on the threaded end (2).

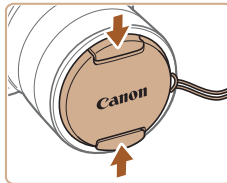

2 Attach the lens cap.

- Remove the lens cap from the lens momentarily, thread the end of the cord through the strap mount (1), and then pull the lens cap through the loop (2).
- Always remove the lens cap before turning the camera on.
- Keep the lens cap on the lens when the camera is not in use.

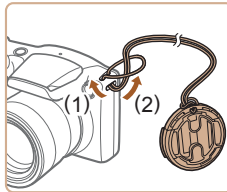

Before Use

Basic Guide

Advanced Guide

1 Camera Basics

2 Auto Mode

3 Other Shooting Modes

4 P Mode

5 Playback Mode

6 Wi-Fi Functions

7 Setting Menu

8 Accessories

9 Appendix

Index

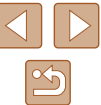

Holding the Camera



- Place the strap around your wrist.
- When shooting, keep your arms close to your body and hold the camera securely to prevent it from moving. If you have raised the flash, do not rest your fingers on it.

Charging the Battery Pack

Before use, charge the battery pack with the included charger. Be sure to charge the battery pack initially, because the camera is not sold with the battery pack charged.

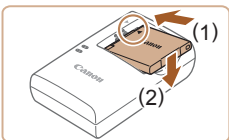

1 Insert the battery pack.

- After aligning the ▲ marks on the battery pack and charger, insert the battery pack by pushing it in (1) and down (2).

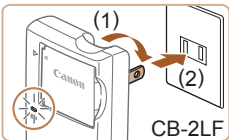

2 Charge the battery pack.

- CB-2LF: Flip out the plug (1) and plug the charger into a power outlet (2).
- CB-2LFE: Plug the power cord into the charger, then plug the other end into a power outlet.
- The charging lamp turns orange, and charging begins.
- When charging is finished, the lamp turns green.

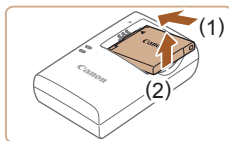
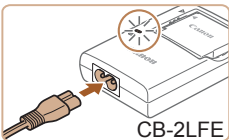

3 Remove the battery pack.

- After unplugging the battery charger, remove the battery pack by pushing it in (1) and up (2).



- To protect the battery pack and keep it in optimal condition, do not charge it continuously for more than 24 hours.
- For battery chargers that use a power cord, do not attach the charger or cord to other objects. Doing so could result in malfunction or damage to the product.



- For details on charging time and the number of shots and recording time possible with a fully charged battery pack, see “Number of Shots/Recording Time, Playback Time” (142).
- Charged battery packs gradually lose their charge, even when they are not used. Charge the battery pack on (or immediately before) the day of use.
- The charger can be used in areas with 100 – 240 V AC power (50/60 Hz). For power outlets in a different format, use a commercially available adapter for the plug. Never use an electrical transformer designed for traveling, which may damage the battery pack.

Before Use

Basic Guide

Advanced Guide

1 Camera Basics

2 Auto Mode

3 Other Shooting Modes

4 P Mode

5 Playback Mode

6 Wi-Fi Functions

7 Setting Menu

8 Accessories

9 Appendix

Index



Inserting the Battery Pack and Your Memory Card (Commercially Available)

Insert the included battery pack and a memory card (commercially available).

Note that before using a memory card that is new or has been formatted in another device, you should format the memory card with this camera (📖109).

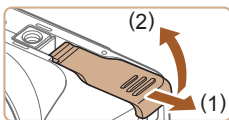

1 Open the cover.

- Slide the cover (1) and open it (2).

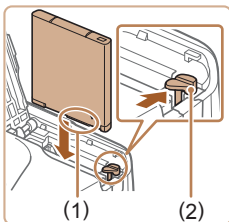

2 Insert the battery pack.

- Holding the battery pack with the terminals (1) facing as shown, press the battery lock (2) in the direction of the arrow and insert the battery pack until the lock clicks shut.
- If you insert the battery pack facing the wrong way, it cannot be locked into the correct position. Always confirm that the battery pack is facing the right way and locks when inserted.

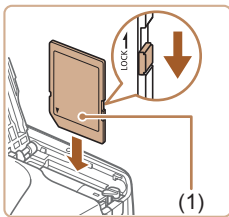

3 Check the card's write-protect switch and insert the memory card.

- Recording is not possible on memory cards with a write-protect switch when the switch is in the locked position. Slide the switch to the unlocked position.
- Insert the memory card with the label (1) facing as shown until it clicks into place.

- Make sure the memory card is facing the right way when you insert it. Inserting memory cards facing the wrong way may damage the camera.

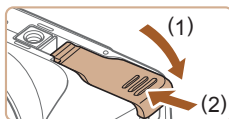

4 Close the cover.

- Lower the cover (1) and hold it down as you slide it, until it clicks into the closed position (2).



- For guidelines on how many shots or hours of recording can be saved on one memory card, see "Number of Shots per Memory Card" (📖143).

Removing the Battery Pack and Memory Card

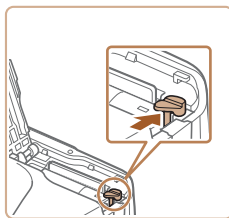

Removing the Battery Pack

- Open the cover and press the battery lock in the direction of the arrow.
- The battery pack will pop up.

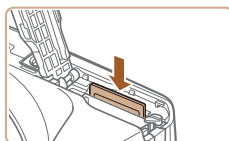

Removing the Memory Card

- Push the memory card in until it clicks, and then slowly release it.
- The memory card will pop up.

Before Use

Basic Guide

Advanced Guide

1 Camera Basics

2 Auto Mode

3 Other Shooting Modes

4 P Mode

5 Playback Mode

6 Wi-Fi Functions

7 Setting Menu

8 Accessories

9 Appendix

Index



Setting the Date and Time

Set the current date and time correctly as follows if the [Date/Time] screen is displayed when you turn the camera on. Information you specify this way is recorded in image properties when you shoot, and it is used when you manage images by shooting date or print images showing the date. You can also add a date stamp to shots, if you wish (135).



1 Turn the camera on.

- Press the ON/OFF button.
- The [Date/Time] screen is displayed.

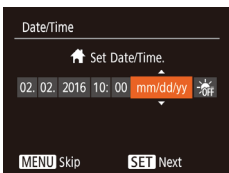

2 Set the date and time.

- Press the [◀][▶] buttons to choose an item.
- Press the [▲][▼] buttons to specify the date.
- When finished, press the [OK] button.

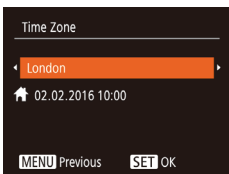

3 Specify your home time zone.

- Press the [◀][▶] buttons to choose your home time zone.

4 Finish the setup process.

- Press the [OK] button when finished. After a confirmation message, the setting screen is no longer displayed.
- To turn off the camera, press the ON/OFF button.



- Unless you set the date, time, and home time zone, the [Date/Time] screen will be displayed each time you turn the camera on. Specify the correct information.



- To set daylight saving time (1 hour ahead), choose [DST] in step 2 and then choose [On] by pressing the [▲][▼] buttons.

Changing the Date and Time

Adjust the date and time as follows.

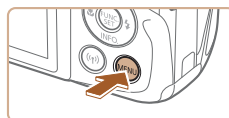

1 Access the menu screen.

- Press the [MENU] button.

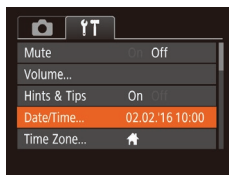

2 Choose [Date/Time].

- Move the zoom lever to choose the [Date/Time] tab.
- Press the [▲][▼] buttons to choose [Date/Time], and then press the [OK] button.



3 Change the date and time.

- Follow step 2 in “Setting the Date and Time” (17) to adjust the settings.
- Press the [MENU] button to close the menu screen.

Before Use

Basic Guide

Advanced Guide

1 Camera Basics

2 Auto Mode

3 Other Shooting Modes

4 P Mode

5 Playback Mode

6 Wi-Fi Functions

7 Setting Menu

8 Accessories

9 Appendix

Index





- There is a build-in date/time battery (backup battery) in the camera. Date/time settings can be retained for about 3 weeks after the battery pack is removed.
- The date/time battery will be charged in about 4 hours once you insert a charged battery pack, even if the camera is left off.
- Once the date/time battery is depleted, the [Date/Time] screen will be displayed when you turn the camera on. Set the correct date and time as described in "Setting the Date and Time" (p.17).

Display Language

Change the display language as needed.



1 Enter Playback mode.

- Press the [▶] button.

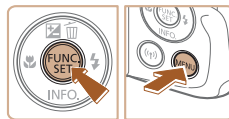

2 Access the setting screen.

- Press and hold the [Ⓜ] button, and then immediately press the [MENU] button.

English	Norsk	Română
Deutsch	Svenska	Türkçe
Français	Español	العربية
Nederlands	Ελληνικά	ភាសាខ្មែរ
Dansk	Русский	简体中文
Português	Polski	繁體中文
Suomi	Čeština	한국어

3 Set the display language.

- Press the [▲][▼][◀][▶] buttons to choose a language, and then press the [Ⓜ] button.
- Once the display language has been set, the setting screen is no longer displayed.



- The current time is displayed if you wait too long in step 2 after pressing the [Ⓜ] button before you press the [MENU] button. In this case, press the [Ⓜ] button to dismiss the time display and repeat step 2.
- You can also change the display language by pressing the [MENU] button and choosing [Language] (🌐) on the [f1] tab.

Before Use

Basic Guide

Advanced Guide

1 Camera Basics

2 Auto Mode

3 Other Shooting Modes

4 P Mode

5 Playback Mode

6 Wi-Fi Functions

7 Setting Menu

8 Accessories

9 Appendix

Index



Trying the Camera Out

► Still Images ► Movies

Follow these instructions to turn the camera on, shoot still images or movies, and then view them.

Shooting (Smart Auto)

For fully automatic selection of the optimal settings for specific scenes, simply let the camera determine the subject and shooting conditions.



1 Turn the camera on.

- Press the ON/OFF button.
- The startup screen is displayed.



2 Enter [AUTO] mode.

- Press the [AUTO] button several times until [AUTO] is displayed.
- Aim the camera at the subject. The camera will make a slight clicking noise as it determines the scene.
- Icons representing the scene and image stabilization mode are displayed in the upper right of the screen.
- Frames displayed around any detected subjects indicate that they are in focus.

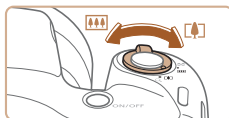

3 Compose the shot.

- To zoom in and enlarge the subject, move the zoom lever toward [T] (telephoto), and to zoom away from the subject, move it toward [W] (wide angle).

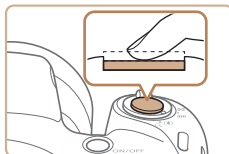

4 Shoot.

Shooting Still Images

1) Focus.

- Press the shutter button lightly, halfway down. The camera beeps twice after focusing, and AF frames are displayed to indicate image areas in focus.
- If [Raise the flash] is displayed, lift the flash with your finger to prepare it for use. If you prefer not to use the flash, push it down with your finger, into the camera.

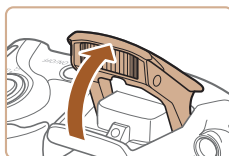

Before Use

Basic Guide

Advanced Guide

1 Camera Basics

2 Auto Mode

3 Other Shooting Modes

4 P Mode

5 Playback Mode

6 Wi-Fi Functions

7 Setting Menu

8 Accessories

9 Appendix

Index

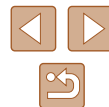

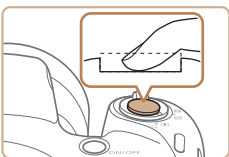

2) Shoot.

- Press the shutter button all the way down.
- As the camera shoots, a shutter sound is played, and in low-light conditions when you have raised the flash, it fires automatically.
- Keep the camera still until the shutter sound ends.
- After displaying your shot, the camera will revert to the shooting screen.



(1)

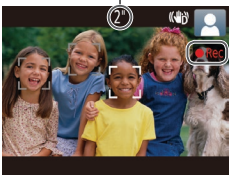

Recording Movies

1) Start recording.

- Press the movie button. The camera beeps once as recording begins, and [●Rec] is displayed with the elapsed time (1).
- Black bars are displayed on the top and bottom edges of the screen, and the subject is slightly enlarged. The black bars indicate image areas not recorded.
- Frames displayed around any detected faces indicate that they are in focus.
- Once recording begins, take your finger off the movie button.



2) Finish recording.

- Press the movie button again to stop recording. The camera beeps twice as recording stops.

Viewing

After shooting images or movies, you can view them on the screen as follows.

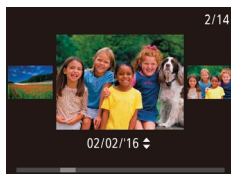

1 Enter Playback mode.

- Press the [▶] button.
- Your last shot is displayed.

2 Choose an image.

- To view the previous image, press the [◀] button. To view the next image, press the [▶] button.

- To access this screen (Scroll Display mode), press and hold the [◀][▶] buttons for at least one second. In this mode, press the [◀][▶] buttons to browse through images.
- To return to single-image display, press the [SET] button.
- Movies are identified by a [SET ▶] icon. To play movies, go to step 3.

Before Use

Basic Guide

Advanced Guide

1 Camera Basics

2 Auto Mode

3 Other Shooting Modes

4 P Mode

5 Playback Mode

6 Wi-Fi Functions

7 Setting Menu

8 Accessories

9 Appendix

Index



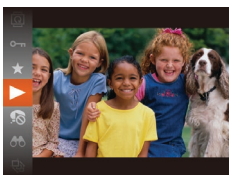

3 Play movies.

- Press the button, press the [][] buttons to choose [], and then press the button again.
- Playback now begins, and after the movie is finished, [] is displayed
- To adjust the volume, press the [][] buttons.



- To switch to Shooting mode from Playback mode, press the shutter button halfway.

Erasing Images

You can choose and erase unneeded images one by one. Note that erased images cannot be recovered. Be sure that you want to erase images before using this option.

1 Choose an image to erase.

- Press the [][] buttons to choose an image.

2 Erase the image.

- Press the [] button.
- After [Erase?] is displayed, press the [][] buttons to choose [Erase], and then press the button.
- The current image is now erased.
- To cancel erasure, press the [][] buttons to choose [Cancel], and then press the button.



- You can choose multiple images to erase at once (70).

Before Use
Basic Guide
Advanced Guide
1 Camera Basics
2 Auto Mode
3 Other Shooting Modes
4 P Mode
5 Playback Mode
6 Wi-Fi Functions
7 Setting Menu
8 Accessories
9 Appendix
Index



Advanced Guide

1

Camera Basics

Other basic operations and more ways to enjoy your camera, including shooting and playback options

On/Off

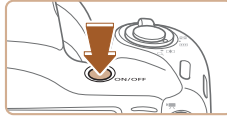

Shooting Mode

- Press the ON/OFF button to turn the camera on and prepare for shooting.
- To turn the camera off, press the ON/OFF button again.

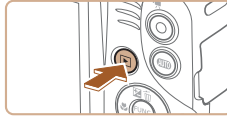

Playback Mode

- Press the [▶] button to turn the camera on and view your shots.
- To turn the camera off, press the [▶] button again.



- To switch to Playback mode from Shooting mode, press the [▶] button.
- To switch to Shooting mode from Playback mode, press the shutter button halfway (p.23).
- The lens will be retracted after about one minute once the camera is in Playback mode. You can turn the camera off when the lens is retracted by pressing the [▶] button.

Before Use

Basic Guide

Advanced Guide

1 Camera Basics

2 Auto Mode

3 Other Shooting Modes

4 P Mode

5 Playback Mode

6 Wi-Fi Functions

7 Setting Menu

8 Accessories

9 Appendix

Index

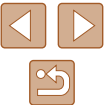

Power-Saving Features (Auto Power Down)

As a way to conserve battery power, the camera automatically deactivates the screen (Display Off) and then turns itself off after a specific period of inactivity.

Power Saving in Shooting Mode

The screen is automatically deactivated after about one minute of inactivity. In about two more minutes, the lens is retracted and the camera turns itself off. To activate the screen and prepare for shooting when the screen is off but the lens is still out, press the shutter button halfway (📖23).

Power Saving in Playback Mode

The camera turns itself off automatically after about five minutes of inactivity.



- You can deactivate Auto Power Down and adjust the timing of Display Off, if you prefer (📖108).
- Power saving is not active while the camera is connected to other devices via Wi-Fi (📖78), or when connected to a computer (📖117).

Shutter Button

To ensure your shots are in focus, always begin by holding the shutter button halfway down, and once the subject is in focus, press the button all the way down to shoot.

In this manual, shutter button operations are described as pressing the button halfway or all the way down.

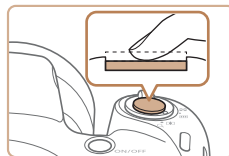

1 Press halfway. (Press lightly to focus.)

- Press the shutter button halfway. The camera beeps twice, and frames are displayed around image areas in focus.

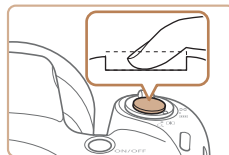

2 Press all the way down. (From the halfway position, press fully to shoot.)

- The camera shoots, as a shutter sound is played.
- Keep the camera still until the shutter sound ends.



- Images may be out of focus if you shoot without initially pressing the shutter button halfway.
- Length of shutter sound playback varies depending on the time required for the shot. It may take longer in some shooting scenes, and images will be blurry if you move the camera (or the subject moves) before the shutter sound ends.

Before Use

Basic Guide

Advanced Guide

1 Camera Basics

2 Auto Mode

3 Other Shooting Modes

4 P Mode

5 Playback Mode

6 Wi-Fi Functions

7 Setting Menu

8 Accessories



9 Appendix

Index



Shooting Display Options

Press the [▼] button to view other information on the screen, or to hide the information. For details on the information displayed, see “On-Screen Information” (p.132).

	Information Display
	No Information Display



- Screen brightness is automatically increased by the night view function when you are shooting under low light, making it easier to check how shots are composed. However, on-screen image brightness may not match the brightness of your shots. Note that any on-screen image distortion or jerky subject motion will not affect recorded images.
- For playback display options, see “Switching Display Modes” (p.63).

Using the FUNC. Menu

Configure commonly used functions through the FUNC. menu as follows. Note that menu items and options vary depending on the shooting mode (p.135) or playback mode (p.140).



(1)
(2)

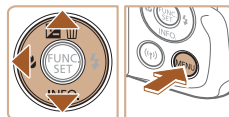

1 Access the FUNC. menu.

- Press the [FUNC. SET] button.

2 Choose a menu item.

- Press the [▲][▼] buttons to choose a menu item (1), and then press the [FUNC.] or [▶] button.
- Available options (2) are listed next to menu items, on the right.
- Depending on the menu item, functions can be specified simply by pressing the [FUNC.] or [▶] button, or another screen is displayed for configuring the function.

3 Choose an option.

- Press the [▲][▼] buttons to choose an item.
- Options labeled with a [MENU] icon can be configured by pressing the [MENU] button.
- To return to the menu items, press the [◀] button.

Before Use

Basic Guide

Advanced Guide

1 Camera Basics

2 Auto Mode

3 Other Shooting Modes

4 P Mode

5 Playback Mode

6 Wi-Fi Functions

7 Setting Menu

8 Accessories

9 Appendix

Index





4 Finish the setup process.

- Press the [MENU] button.
- The screen before you pressed the [MENU] button in step 1 is displayed again, showing the option you configured.



- To undo any accidental setting changes, you can restore the camera's default settings (112).

Using the Menu Screen

Configure a variety of camera functions through the menu screen as follows. Menu items are grouped by purpose on tabs, such as shooting [CAMERA], playback [REPLAY], and so on. Note that available menu items vary depending on the selected shooting or playback mode (137 – 140).

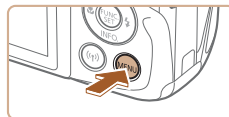

1 Access the menu screen.

- Press the [MENU] button.



2 Choose a tab.

- Move the zoom lever to choose a tab.
- After you have pressed the [▲][▼] buttons to choose a tab initially, you can switch between tabs by pressing the [◀][▶] buttons.

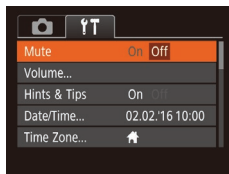
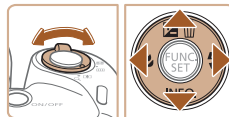

3 Choose a menu item.

- Press the [▲][▼] buttons to choose an item.
- For menu items with options not shown, first press the [MENU] or [▶] button to switch screens, and then press the [▲][▼] buttons to select the menu item.
- To return to the previous screen, press the [MENU] button.

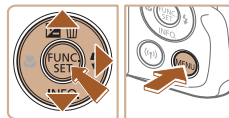

Before Use

Basic Guide

Advanced Guide

1 Camera Basics

2 Auto Mode

3 Other Shooting Modes

4 P Mode

5 Playback Mode

6 Wi-Fi Functions

7 Setting Menu

8 Accessories

9 Appendix

Index

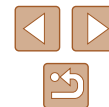

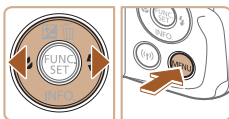
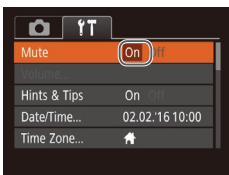

4 Choose an option.

- Press the [◀][▶] buttons to choose an option.

5 Finish the setup process.

- Press the [MENU] button to return to the screen displayed before you pressed the [MENU] button in step 1.



- To undo any accidental setting changes, you can restore the camera's default settings (112).

On-Screen Keyboard

Use the on-screen keyboard to enter information for Wi-Fi connections (78). Note that the length and type of information you can enter varies depending on the function you are using.

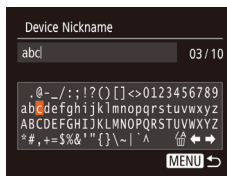

Entering Characters

- Press the [▲][▼][◀][▶] buttons to choose a character, and then press the [Ⓜ] button to enter it.

Moving the Cursor

- Choose [◀] or [▶] and press the [Ⓜ] button.

Deleting Characters

- Choose [⏪] and press the [Ⓜ] button. The previous character will be deleted.

Confirming Input and Returning to the Previous Screen

- Press the [MENU] button.

Before Use

Basic Guide

Advanced Guide

1 Camera Basics

2 Auto Mode

3 Other Shooting Modes

4 P Mode

5 Playback Mode

6 Wi-Fi Functions

7 Setting Menu

8 Accessories

9 Appendix

Index



Indicator Display

When the following conditions occur, the camera's indicator (📖4) blinks green.

- Connecting to a computer (📖117)
- Display off (📖23, 📖108, 📖108)
- Starting up, recording/reading a memory card
- Any kind of connecting
- When shooting in Long Shutter mode (📖47)
- Connecting to Wi-Fi/Receiving data



- When the indicator blinks green, never turn the camera off, open the memory card/battery cover, or shake or jolt the camera. These actions may corrupt images or damage the camera or memory card.

Clock

You can check the current time.



- Press and hold the [FUNC/SET] button.
- The current time appears.
- If you hold the camera vertically while using the clock function, it will switch to vertical display. Press the [◀][▶] buttons to change the display color.
- Press the [FUNC/SET] button again to cancel the clock display.



- When the camera is off, press and hold the [FUNC/SET] button, then press the ON/OFF button to display the clock.

Before Use

Basic Guide

Advanced Guide

1 Camera Basics

2 Auto Mode

3 Other Shooting Modes

4 P Mode

5 Playback Mode

6 Wi-Fi Functions

7 Setting Menu

8 Accessories

9 Appendix

Index

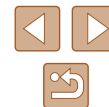

2

Auto Mode

Convenient mode for easy shots with greater control over shooting

Shooting with Camera-Determined Settings

For fully automatic selection of the optimal settings for specific scenes, simply let the camera determine the subject and shooting conditions.

Shooting (Smart Auto)

▶ Still Images ▶ Movies



1 Turn the camera on.

- Press the ON/OFF button.
- The startup screen is displayed.



2 Enter [AUTO] mode.

- Press the [AUTO] button several times until [AUTO] is displayed.
- Aim the camera at the subject. The camera will make a slight clicking noise as it determines the scene.
- Icons representing the scene and image stabilization mode are displayed in the upper right of the screen (31, 32).
- Frames displayed around any detected subjects indicate that they are in focus.



Before Use

Basic Guide

Advanced Guide

1 Camera Basics

2 Auto Mode

3 Other Shooting Modes

4 P Mode

5 Playback Mode

6 Wi-Fi Functions

7 Setting Menu

8 Accessories

9 Appendix

Index



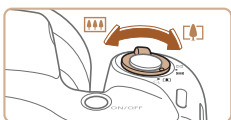

(1)



3 Compose the shot.

- To zoom in and enlarge the subject, move the zoom lever toward [T] (telephoto), and to zoom away from the subject, move it toward [W] (wide angle). (A zoom bar (1) showing the zoom position is displayed.)
- To zoom in or out quickly, move the zoom lever all the way toward [T] (telephoto) or [W] (wide angle), and to zoom in or out slowly, move it just a little in the desired direction.

4 Shoot.

Shooting Still Images

1) Focus.

- Press the shutter button halfway. The camera beeps twice after focusing, and AF frames are displayed to indicate image areas in focus.
- Several AF frames are displayed when multiple areas are in focus.
- If [Raise the flash] is displayed, lift the flash with your finger to prepare it for use. If you prefer not to use the flash, push it down with your finger, into the camera.

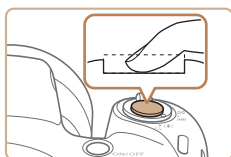
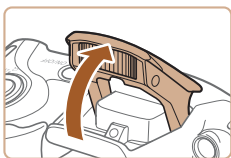
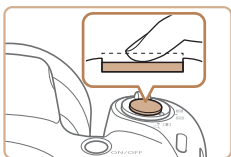

2) Shoot.

- Press the shutter button all the way down.
- As the camera shoots, a shutter sound is played, and in low-light conditions when you have raised the flash, it fires automatically.
- Keep the camera still until the shutter sound ends.
- After displaying your shot, the camera will revert to the shooting screen.



Recording Movies

1) Start recording.

- Press the movie button. The camera beeps once as recording begins, and [Rec] is displayed with the elapsed time (1).
- Black bars are displayed on the top and bottom edges of the screen, and the subject is slightly enlarged. The black bars indicate image areas not recorded.
- Frames displayed around any detected faces indicate that they are in focus.
- Once recording begins, take your finger off the movie button.

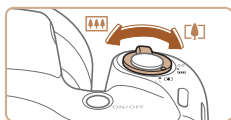
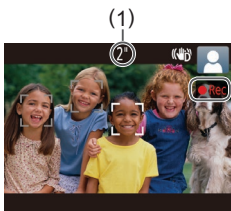

2) Resize the subject and recompose the shot as needed.

- To resize the subject, repeat the operations in step 3. However, note that the sound of camera operations will be recorded. Note that movies shot at zoom factors shown in blue will look grainy.

Before Use

Basic Guide

Advanced Guide

1 Camera Basics

2 Auto Mode

3 Other Shooting Modes

4 P Mode

5 Playback Mode

6 Wi-Fi Functions

7 Setting Menu

8 Accessories

9 Appendix

Index



- When you recompose shots, the focus, brightness, and colors will be automatically adjusted.



3) Finish recording.

- Press the movie button again to stop recording. The camera beeps twice as recording stops.
- Recording will stop automatically when the memory card becomes full.

Still Images/Movies



- If the camera is turned on while the [▼] button is held down, the camera will no longer sound. To activate sounds again, press the [MENU] button and choose [Mute] on the [↑] tab, and then press the [◀][▶] buttons to choose [Off].

Still Images



- A blinking [📷] icon warns that images are more likely to be blurred by camera shake. In this case, mount the camera on a tripod or take other measures to keep it still.
- If your shots are dark despite the flash firing, move closer to the subject. For details on the flash range, see “Camera” (📖141).
- The subject may be too close if the camera only beeps once when you press the shutter button halfway. For details on the range of focus (shooting range), see “Shooting Range” (📖142).
- To reduce red-eye and to assist in focusing, the lamp may be lit when shooting in low-light conditions.
- A blinking [📷] icon displayed when you attempt to shoot indicates that shooting is not possible until the flash has finished recharging. Shooting can resume as soon as the flash is ready, so either press the shutter button all the way down and wait, or release it and press it again.
- Although you can shoot again before the shooting screen is displayed, your previous shot may determine the focus, brightness, and colors used.



- You can change how long images are displayed after shots (📖40).

Before Use

Basic Guide

Advanced Guide

1 Camera Basics

2 Auto Mode

3 Other Shooting Modes

4 P Mode

5 Playback Mode

6 Wi-Fi Functions

7 Setting Menu

8 Accessories

9 Appendix

Index



Movies



- Before shooting a movie, lower the flash with your finger. Be careful not to touch the microphone (1) when shooting a movie. Leaving the flash raised, or blocking the microphone may prevent audio from being recorded or may cause the recording to sound muffled.

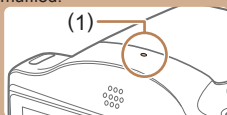

- Avoid touching camera controls other than the movie button when shooting movies, because sounds made by the camera will be recorded.
- Once movie recording begins, the image display area changes and subjects are enlarged to allow for correction of significant camera shake. To shoot subjects at the same size shown before shooting, adjust the image stabilization setting (p. 59).



- Audio recording is monaural.

Scene Icons

► Still Images ► Movies

In [AUTO] mode, shooting scenes determined by the camera are indicated by the icon displayed, and corresponding settings are automatically selected for optimal focusing, subject brightness, and color.

Background	When Shooting People			Icon Background Color
	People	In Motion*1	Shadows on Face*1	
Bright				Gray
Bright and Backlit			—	
With Blue Sky				Light Blue
Blue Sky and Backlit			—	
Spotlights				Dark Blue
Dark				
Dark, Using Tripod		—	—	

Before Use

Basic Guide

Advanced Guide

1 Camera Basics

2 Auto Mode

3 Other Shooting Modes

4 P Mode

5 Playback Mode

6 Wi-Fi Functions

7 Setting Menu

8 Accessories

9 Appendix

Index



Background	When Shooting Other Subjects			Icon Background Color
	Other Subjects	In Motion*1	At Close Range	
Bright				Gray
Bright and Backlit				
With Blue Sky				Light Blue
Blue Sky and Backlit				
Sunsets			—	Orange
Spotlights				Dark Blue
Dark				
Dark, Using Tripod		—	—	

*1 Not displayed for movies.

*2 Displayed in dark scenes when the camera is held still, as when mounted on a tripod.



- The scene icon may not match actual shooting conditions, or it may not be possible to shoot with your expected effect, color, or brightness. If such a case occurs, it is recommended that you shoot in **P** mode (p.49).

Image Stabilization Icons

► Still Images ► Movies

Optimal image stabilization for the shooting conditions is automatically applied (Intelligent IS). Additionally, the following icons are displayed in **[AUTO]** mode.

	Image stabilization for still images (Normal)
	Image stabilization for still images when panning (Panning)*
	Image stabilization for angle camera shake and shift camera shake when shooting with macro (Hybrid IS). In movies, is displayed, and can further stabilize the image.
	Image stabilization for movies, reducing strong camera shake, as when shooting while walking (Dynamic)
	Image stabilization for slow camera shake, such as when shooting movies at telephoto (Powered)
	No image stabilization, because the camera is mounted on a tripod or held still by other means. However, during movie recording, is displayed, and image stabilization to counteract wind or other sources of vibration is used (Tripod IS).

* Displayed when you pan, following moving subjects with the camera. When you follow subjects moving horizontally, image stabilization only counteracts vertical camera shake, and horizontal stabilization stops. Similarly, when you follow subjects moving vertically, image stabilization only counteracts horizontal camera shake.



- To cancel image stabilization, set [IS Mode] to [Off] (p.59). In this case, an IS icon is not displayed.

Before Use

Basic Guide

Advanced Guide

1 Camera Basics

2 Auto Mode

3 Other Shooting Modes

4 P Mode

5 Playback Mode

6 Wi-Fi Functions

7 Setting Menu

8 Accessories

9 Appendix

Index



On-Screen Frames

► Still Images ► Movies

A variety of frames are displayed once the camera detects subjects you are aiming the camera at.

- A white frame is displayed around the subject (or person's face) determined by the camera to be the main subject, and gray frames are displayed around other detected faces. Frames follow moving subjects within a certain range to keep them in focus. However, if the camera detects subject movement, only the white frame will remain on the screen.
- When you are pressing the shutter button halfway and the camera detects subject movement, a blue frame is displayed, and the focus and image brightness are constantly adjusted (Servo AF).



- Depending on the shooting conditions and subject, no frames may be displayed, frames may not be displayed around desired subjects, or frames may be displayed on the background or similar areas. If such a case occurs, it is recommended that you shoot in [P] mode (p.49).

Common, Convenient Features

► Still Images ► Movies

Zooming In Closer on Subjects (Digital Zoom)

When distant subjects are too far away to enlarge using the optical zoom, use digital zoom for up to about 168x enlargement.

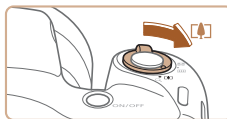

1 Move the zoom lever toward [Z].

- Hold the lever until zooming stops.
- Zooming stops at the largest zoom factor before the image becomes noticeably grainy, which is then indicated on the screen.

2 Move the zoom lever toward [Z] again.

- The camera zooms in even closer on the subject.
- (1) is the current zoom factor.

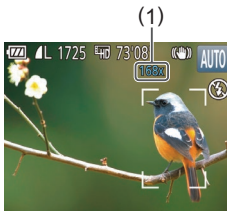

Before Use

Basic Guide

Advanced Guide

1 Camera Basics

2 Auto Mode

3 Other Shooting Modes

4 P Mode

5 Playback Mode

6 Wi-Fi Functions

7 Setting Menu

8 Accessories

9 Appendix

Index

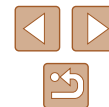



- Moving the zoom lever will display the zoom bar (which indicates the zoom position). The color of the zoom bar will change depending on the zoom range.
 - White range: optical zoom range where the image will not appear grainy.
 - Yellow range: digital zoom range where the image is not noticeably grainy (ZoomPlus).
 - Blue range: digital zoom range where the image will appear grainy.
- Because the blue range will not be available at some recording pixel settings (📖37), the maximum zoom factor can be achieved by following step 1.



- To deactivate digital zoom, choose MENU (📖25) > [📷] tab > [Digital Zoom] > [Off].

Using the Self-Timer

▶ Still Images ▶ Movies

With the self-timer, you can include yourself in group photos or other timed shots. The camera will shoot about 10 seconds after you press the shutter button.



1 Configure the setting.

- Press the [📷] button, choose [🕒] in the menu, and then choose [🕒] (📖24).
- Once the setting is complete, [🕒] is displayed.

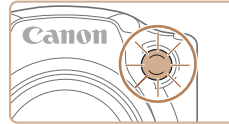

2 Shoot.

- For Still Images: Press the shutter button halfway to focus on the subject, and then press it all the way down.
- For Movies: Press the movie button.
- Once you start the self-timer, the lamp will blink and the camera will play a self-timer sound.
- Two seconds before the shot, the blinking and sound will speed up. (The lamp will remain lit in case the flash fires.)
- To cancel shooting after you have triggered the self-timer, press the [MENU] button.
- To restore the original setting, choose [🕒] in step 1.

Using the Self-Timer to Avoid Camera Shake

▶ Still Images ▶ Movies

This option delays shutter release until about two seconds after you have pressed the shutter button. If the camera is unsteady while you are pressing the shutter button, it will not affect your shot.



- Follow step 1 in “Using the Self-Timer” (📖34) and choose [🕒].
- Once the setting is complete, [🕒] is displayed.
- Follow step 2 in “Using the Self-Timer” (📖34) to shoot.

Before Use

Basic Guide

Advanced Guide

1 Camera Basics

2 Auto Mode

3 Other Shooting Modes

4 P Mode

5 Playback Mode

6 Wi-Fi Functions

7 Setting Menu

8 Accessories

9 Appendix

Index

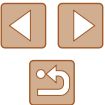

Customizing the Self-Timer

► Still Images ► Movies

You can specify the delay (0 – 30 seconds) and number of shots (1 – 10).

1 Choose [C].

- Following step 1 in “Using the Self-Timer” (📖 34), choose [C] and press the [MENU] button immediately.

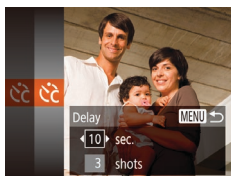

2 Configure the setting.

- Press the [▲][▼] buttons to choose [Delay] or [Shots].
- Press the [◀][▶] buttons to choose a value, and then press the [OK] button.
- Once the setting is complete, [C] is displayed.
- Follow step 2 in “Using the Self-Timer” (📖 34) to shoot.



- For movies shot using the self-timer, [Delay] represents the delay before recording begins, but the [Shots] setting has no effect.



- When you specify multiple shots, image brightness and white balance are determined by the first shot. More time is required between shots when the flash fires or when you have specified to take many shots. Shooting will stop automatically when the memory card becomes full.
- When a delay longer than two seconds is specified, two seconds before the shot, the lamp blinking and self-timer sound will speed up. (The lamp will remain lit in case the flash fires.)

Adding a Date Stamp

► Still Images ► Movies

The camera can add the shooting date to images, in the lower-right corner.

However, note that date stamps cannot be edited or removed, so confirm beforehand that the date and time are correct (📖 17).

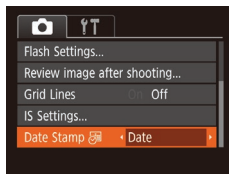
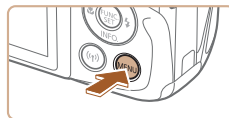

1 Configure the setting.

- Press the [MENU] button, choose [Date Stamp] on the [CAMERA] tab, and then choose the desired option (📖 25).
- Once the setting is complete, [Date] is displayed.

2 Shoot.

- As you take shots, the camera adds the shooting date or time to the lower-right corner of images.
- To restore the original setting, choose [Off] in step 1.



- Date stamps cannot be edited or removed.

Before Use

Basic Guide

Advanced Guide

1 Camera Basics

2 Auto Mode

3 Other Shooting Modes

4 P Mode

5 Playback Mode

6 Wi-Fi Functions

7 Setting Menu

8 Accessories

9 Appendix

Index





- Shots taken without adding a date stamp can be printed with one as follows.
However, adding a date stamp this way to images that already have one may cause it to be printed twice.
 - Print using printer functions (📖119)
 - Use camera DPOF print settings (📖123) to print

Continuous Shooting

▶ Still Images ▶ Movies

Hold the shutter button all the way down to shoot continuously.
For details on the continuous shooting speed, see “Camera” (📖141).

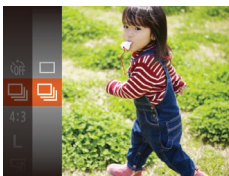

1 Configure the setting.

- Press the button, choose in the menu, and then choose (📖24).
- Once the setting is complete, is displayed.

2 Shoot.

- Hold the shutter button all the way down to shoot continuously.



- During continuous shooting, focus and exposure are locked at the position/level determined when you pressed the shutter button halfway.
- Cannot be used with the self-timer (📖34).
- Shooting may stop momentarily or continuous shooting may slow down depending on shooting conditions, camera settings, and the zoom position.
- As more shots are taken, shooting may slow down.
- Shooting may slow down if the flash fires.

Before Use
Basic Guide
Advanced Guide
1 Camera Basics
2 Auto Mode
3 Other Shooting Modes
4 P Mode
5 Playback Mode
6 Wi-Fi Functions
7 Setting Menu
8 Accessories
9 Appendix
Index



Image Customization Features

Changing the Aspect Ratio

► Still Images ► Movies

Change the image aspect ratio (ratio of width to height) as follows.



- Press the [FUNC.] button, choose [4:3] in the menu, and choose the desired option (143).
- Once the setting is complete, the screen aspect ratio will be updated.
- To restore the original setting, repeat this process but choose [4:3].



16:9	Same aspect ratio as widescreen HDTVs.
3:2	Same aspect ratio as 35mm film. Used for printing images at 5 x 7-inch or postcard sizes.
4:3	Native aspect ratio of the camera screen. Used for display on standard-definition televisions or similar display devices. Also used for printing images at 3.5 x 5-inch or A-series sizes.
1:1	Square aspect ratio.

Changing Image Resolution (Size)

► Still Images ► Movies

Choose from 4 levels of image resolution, as follows. For guidelines on how many shots at each recording pixel setting can fit on a memory card, see “Number of Shots per Memory Card” (143).



- Press the [FUNC.] button, choose [L] in the menu, and choose the desired option (24).
- The option you configured is now displayed.
- To restore the original setting, repeat this process but choose [L].

Guidelines for Choosing Resolution Based on Paper Size (for 4:3 Images)

L	A2 (16.5 x 23.4 in.)
M1	A3 – A5 (11.7 x 16.5 – 5.8 x 8.3 in.)
M2	3.5 x 5 in., 5 x 7 in., Postcard
S	For e-mailing and similar purposes

Before Use

Basic Guide

Advanced Guide

1 Camera Basics

2 Auto Mode

3 Other Shooting Modes

4 P Mode

5 Playback Mode

6 Wi-Fi Functions

7 Setting Menu

8 Accessories

9 Appendix

Index



Changing Movie Image Quality

► Still Images ► Movies

2 image quality settings are available. For guidelines on the maximum movie length at each level of image quality that will fit on a memory card, see "Recording Time per Memory Card" (143).



- Press the **[INFO]** button, choose **[HD]** in the menu, and choose the desired option (24).
- The option you configured is now displayed.
- To restore the original setting, repeat this process but choose **[HD]**.

Image Quality	Resolution	Frame Rate	Details
[HD]	1280 x 720	25 fps	For shooting in HD
[VGA]	640 x 480	30 fps	For shooting in standard definition



- In **[HD]** mode, black bars are displayed on the top and bottom edges of the screen. The black bars indicate image areas not recorded.

Helpful Shooting Features

Displaying Grid Lines

► Still Images ► Movies

Grid lines can be displayed on the screen for vertical and horizontal reference while shooting.

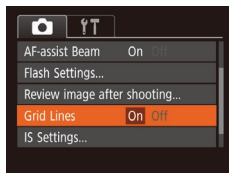
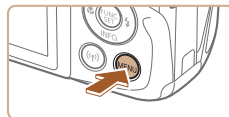

- Press the **[MENU]** button, choose **[Grid Lines]** on the **[CAMERA]** tab, and then choose **[On]** (25).
- Once the setting is complete, grid lines are displayed on the screen.
- To restore the original setting, repeat this process but choose **[Off]**.



- Grid lines are not recorded in your shots.

Before Use

Basic Guide

Advanced Guide

1 Camera Basics

2 Auto Mode

3 Other Shooting Modes

4 P Mode

5 Playback Mode

6 Wi-Fi Functions

7 Setting Menu

8 Accessories

9 Appendix

Index



Magnifying the Area in Focus

► Still Images ► Movies

You can check the focus by pressing the shutter button halfway, which will enlarge the portion of the image in focus in the AF frame.

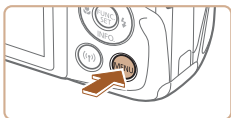

1 Configure the setting.

- Press the [MENU] button, choose [AF-Point Zoom] on the [CAMERA] tab, and then choose [On] (📖25).



2 Check the focus.

- Press the shutter button halfway. The face detected as the main subject is now magnified.
- To restore the original setting, choose [Off] in step 1.



- The area in focus is not magnified in the following cases when the shutter button is pressed halfway.
 - If a face was not detected, if the person is too close to the camera and their face is too large for the screen, or if the camera detects subject movement
 - When digital zoom is used (📖33)
 - When Tracking AF is used (📖56)
 - When a TV is used as a display (📖116)

Customizing Camera Operation

Customize shooting functions on the [CAMERA] tab of the menu screen as follows.

For instructions on menu functions, see “Using the Menu Screen” (📖25).

Deactivating the AF-Assist Beam

► Still Images ► Movies

The lamp normally lights up to help you focus when you press the shutter button halfway in low-light conditions. If you prefer, you can deactivate the lamp.

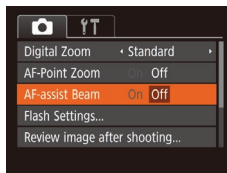

- Press the [MENU] button, choose [AF-assist Beam] on the [CAMERA] tab, and then choose [Off] (📖25).
- To restore the original setting, repeat this process but choose [On].

Before Use

Basic Guide

Advanced Guide

1 Camera Basics

2 Auto Mode

3 Other Shooting Modes

4 P Mode

5 Playback Mode

6 Wi-Fi Functions

7 Setting Menu

8 Accessories

9 Appendix

Index



Deactivating the Red-Eye Reduction Lamp

► Still Images ► Movies

A lamp lights up to reduce red-eye when the flash is used in low-light shots. If you prefer, you can deactivate the lamp.

1 Access the [Flash Settings] screen.

- Press the [MENU] button, choose [Flash Settings] on the [📷] tab, and then press the [⊕] button (📖25).

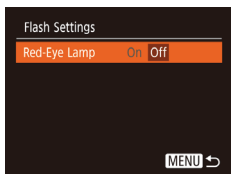

2 Configure the setting.

- Choose [Red-Eye Lamp], and then choose [Off] (📖25).
- To restore the original setting, repeat this process but choose [On].

Changing the Image Display Style after Shots

► Still Images ► Movies

You can change how long images are displayed and what information is displayed immediately after shooting.

Changing the Image Display Period after Shots

1 Access the [Review image after shooting] screen.

- Press the [MENU] button, choose [Review image after shooting] on the [📷] tab, and then press the [⊕] button (📖25).

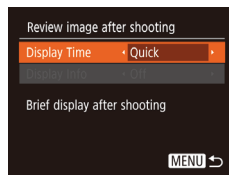

2 Configure the setting.

- Press the [▲][▼] buttons to choose [Display Time]. Press the [◀][▶] buttons to choose the desired option.
- To restore the original setting, repeat this process but choose [Quick].

Quick	Displays images only until you can shoot again.
2 sec., 4 sec., 8 sec.	Displays images for the specified time. Even while the shot is displayed, you can take another shot by pressing the shutter button halfway again.
Hold	Displays images until you press the shutter button halfway.
Off	No image display after shots.

Before Use

Basic Guide

Advanced Guide

1 Camera Basics

2 Auto Mode

3 Other Shooting Modes

4 P Mode

5 Playback Mode

6 Wi-Fi Functions

7 Setting Menu

8 Accessories

9 Appendix

Index

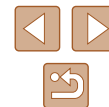

Changing the Screen Displayed after Shots

Change the way images are displayed after shots as follows.

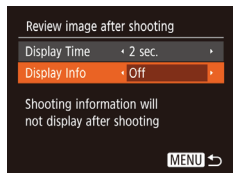

1 Set [Display Time] to [2 sec.], [4 sec.], [8 sec.], or [Hold] (📖40).

2 Configure the setting.

- Press the [▲][▼] buttons to choose [Display Info]. Press the [◀][▶] buttons to choose the desired option.
- To restore the original setting, repeat this process but choose [Off].

Off	Displays only the image.
Detailed	Displays shooting details (📖133).



- When [Display Time] (📖40) is set to [Off] or [Quick], [Display Info] is set to [Off] and cannot be changed.
- By pressing the [▼] button while an image is displayed after shooting, you can switch the display information. Note that the settings of [Display Info] are not changed. You can also erase images by pressing the [▲] button, or protect (📖67) or tag images as favorites (📖72) by pressing the (📖) button.

Before Use

Basic Guide

Advanced Guide

1 Camera Basics

2 Auto Mode

3 Other Shooting Modes

4 P Mode

5 Playback Mode

6 Wi-Fi Functions

7 Setting Menu

8 Accessories

9 Appendix

Index



3

Other Shooting Modes

Shoot more effectively in various scenes, and take shots enhanced with unique image effects or captured using special functions

Brightness / Color Customization (Live View Control)

► Still Images ► Movies

Image brightness or colors when shooting can be easily customized as follows.



1 Enter [LIVE] mode.

- Press the [AUTO] button several times until [LIVE] is displayed.

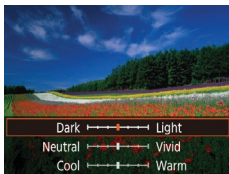

2 Configure the setting.

- Press the [▼] button to access the setting screen. Press the [▲][▼] buttons to choose a setting item, and then press the [◀][▶] buttons to adjust the value as you watch the screen.
- Press the [Ⓜ] button.

3 Shoot.

Brightness	For brighter images, adjust the level to the right, and for darker images, adjust it to the left.
Color	For more vivid images, adjust the level to the right, and for more subdued images, adjust it to the left.
Tone	For a warm, reddish tone, adjust the level to the right, and for a cool, bluish tone, adjust it to the left.

Before Use

Basic Guide

Advanced Guide

1 Camera Basics

2 Auto Mode

3 Other Shooting Modes

4 P Mode

5 Playback Mode

6 Wi-Fi Functions

7 Setting Menu

8 Accessories

9 Appendix

Index

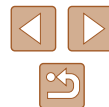

Specific Scenes

Choose a mode matching the shooting scene, and the camera will automatically configure the settings for optimal shots.



1 Choose a shooting mode.

- Press the [AUTO] button several times until [LIVE] is displayed.
- Press the [MENU] button, choose [LIVE] in the menu, and choose the desired option (p.24).

2 Shoot.



Shooting Portraits (Portrait)

▶ Still Images ▶ Movies

- Take shots of people with a softening effect.



Shooting under Low Light (Low Light)

▶ Still Images ▶ Movies

- Shoot with minimal camera and subject shake even in low-light conditions.



Shooting Fireworks (Fireworks)

▶ Still Images ▶ Movies

- Vivid shots of fireworks.



- In [Fireworks] mode, mount the camera on a tripod or take other measures to keep it still and prevent camera shake. Additionally, you should set [IS Mode] to [Off] when using a tripod or other means to secure the camera (p.59).



- [P/A] mode resolution is [M] (2,560 x 1,920 pixels) and cannot be changed.
- In [Fireworks] mode, although no frames are displayed when you press the shutter button halfway, optimal focus is still determined.

Before Use

Basic Guide

Advanced Guide

1 Camera Basics

2 Auto Mode

3 Other Shooting Modes

4 P Mode

5 Playback Mode

6 Wi-Fi Functions

7 Setting Menu

8 Accessories

9 Appendix

Index

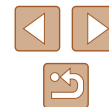

Applying Special Effects

Add a variety of effects to images when shooting.

1 Choose a shooting mode.

- Follow step 1 in “Specific Scenes” (43) to choose a shooting mode.

2 Shoot.

Shooting in Vivid Colors (Super Vivid)

▶ Still Images ▶ Movies

- Shots in rich, vivid colors.





Posterized Shots (Poster Effect)

▶ Still Images ▶ Movies

- Shots that resemble an old poster or illustration.



- In  and  modes, try taking some test shots first, to make sure you obtain the desired results.

Shooting with a Fish-Eye Lens Effect (Fish-Eye Effect)





▶ Still Images ▶ Movies

Shoot with the distorting effect of a fish-eye lens.

1 Choose .

- Follow step 1 in “Specific Scenes” (43) and choose .

2 Choose an effect level.

- Press the  button, press the  buttons to choose an effect level, and then press the  button.
- A preview is shown of how your shot will look with the effect applied.

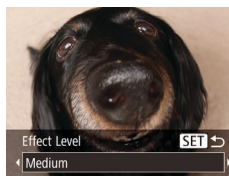

3 Shoot.



- Try taking some test shots first, to make sure you obtain the desired results.

Before Use

Basic Guide

Advanced Guide

1 Camera Basics

2 Auto Mode

3 Other Shooting Modes

4 P Mode

5 Playback Mode

6 Wi-Fi Functions

7 Setting Menu

8 Accessories

9 Appendix

Index



Shots Resembling Miniature Models (Miniature Effect)

► Still Images ► Movies

Creates the effect of a miniature model, by blurring image areas above and below your selected area.
You can also make movies that look like scenes in miniature models by choosing the playback speed before the movie is recorded. People and objects in the scene will move quickly during playback. Note that sound is not recorded.

1 Choose [ZOOM].

- Follow step 1 in “Specific Scenes” (p.43) and choose [ZOOM].
- A white frame is displayed, indicating the image area that will not be blurred.



2 Choose the area to keep in focus.

- Press the [DOWN] button.
- Move the zoom lever to resize the frame, and press the [UP][DOWN] buttons to move it.



3 For movies, choose the movie playback speed.

- Press the [MENU] button, and then press the [LEFT][RIGHT] buttons to choose the speed.

4 Return to the shooting screen and shoot.

- Press the [MENU] button to return to the shooting screen, and then shoot.

Playback Speed and Estimated Playback Time (for One-Minute Clips)

Speed	Playback Time
5x	Approx. 12 sec.
10x	Approx. 6 sec.
20x	Approx. 3 sec.

Movies are played back at 30 fps.



- The zoom is not available when shooting movies. Be sure to set the zoom before shooting.
- Try taking some test shots first, to make sure you obtain the desired results.



- To switch the orientation of the frame to vertical, press the [LEFT][RIGHT] buttons in step 2. To return the frame to horizontal orientation, press the [UP][DOWN] buttons.
- To move the frame when it is in horizontal orientation, press the [UP][DOWN] buttons, and to move the frame when it is in vertical orientation, press the [LEFT][RIGHT] buttons.
- Holding the camera vertically will change the orientation of the frame.
- Movie image quality is [4:3] at an aspect ratio of [VGA] and [16:9] at an aspect ratio of [HD] (p.37). These quality settings cannot be changed.

Before Use

Basic Guide

Advanced Guide

1 Camera Basics

2 Auto Mode

3 Other Shooting Modes

4 P Mode

5 Playback Mode

6 Wi-Fi Functions

7 Setting Menu

8 Accessories

9 Appendix

Index



Shooting with a Toy Camera Effect (Toy Camera Effect)

► Still Images ► Movies

This effect makes images resemble shots from a toy camera by vignetting (darker, blurred image corners) and changing the overall color.

1 Choose [📷].

- Follow step 1 in “Specific Scenes” (📖43) and choose [📷].



2 Choose a color tone.

- Press the [▼] button, press the [◀][▶] buttons to choose a color tone, and then press the [📷] button.
- A preview is shown of how your shot will look with the effect applied.

3 Shoot.

Standard	Shots resemble toy camera images.
Warm	Images have a warmer tone than with [Standard].
Cool	Images have a cooler tone than with [Standard].



- Try taking some test shots first, to make sure you obtain the desired results.

Shooting in Monochrome

► Still Images ► Movies

Shoot images in black and white, sepia, or blue and white.

1 Choose [📷].

- Follow step 1 in “Specific Scenes” (📖43) and choose [📷].

2 Choose a color tone.

- Press the [▼] button, press the [◀][▶] buttons to choose a color tone, and then press the [📷] button.
- A preview is shown of how your shot will look with the effect applied.



3 Shoot.

B/W	Black and white shots.
Sepia	Sepia tone shots.
Blue	Blue and white shots.

Before Use

Basic Guide

Advanced Guide

1 Camera Basics

2 Auto Mode

3 Other Shooting Modes

4 P Mode

5 Playback Mode

6 Wi-Fi Functions

7 Setting Menu

8 Accessories

9 Appendix

Index



Special Modes for Other Purposes

Using the Face Self-Timer

► Still Images ► Movies

The camera will shoot about two seconds after detecting that the face of another person (such as the photographer) (📖56) has entered the shooting area. This is useful when including yourself in group photos or similar shots.



1 Choose [👤].

- Follow step 1 in “Specific Scenes” (📖43) and choose [👤].

2 Compose the shot and press the shutter button halfway.

- Make sure a green frame is displayed around the face you focus on and white frames around other faces.

3 Press the shutter button all the way down.

- The camera now enters shooting standby mode, and [Look straight at camera to start count down] is displayed.
- The lamp blinks and the self-timer sound is played.



4 Join the subjects in the shooting area and look at the camera.

- After the camera detects a new face, the lamp blinking and self-timer sound will speed up. (When the flash fires, the lamp will remain lit.) About two seconds later, the camera will shoot.
- To cancel shooting after you have triggered the self-timer, press the [MENU] button.



- Even if your face is not detected after you join the others in the shooting area, the camera will shoot about 15 seconds later.
- To change the number of shots, after choosing [👤] in step 1, press the [▼] button, choose the number of shots by pressing the [◀][▶] buttons, and then press the [📷] button.

Shooting Long Exposures (Long Shutter)

► Still Images ► Movies

Specify a shutter speed of 1 – 15 seconds to shoot long exposures. In this case, mount the camera on a tripod or take other measures to prevent camera shake.

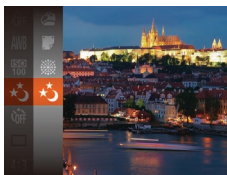

1 Choose [⌘].

- Follow step 1 in “Specific Scenes” (📖43) and choose [⌘].

Before Use

Basic Guide

Advanced Guide

1 Camera Basics

2 Auto Mode

3 Other Shooting Modes

4 P Mode

5 Playback Mode

6 Wi-Fi Functions

7 Setting Menu

8 Accessories

9 Appendix

Index



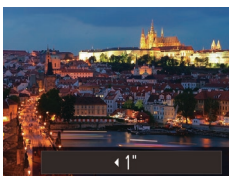

2 Choose the shutter speed.

- Press the [▲] button, press the [◀][▶] buttons to choose the shutter speed, and then press the [Ⓢ] button.

3 Check the exposure.

- Press the shutter button halfway to view the exposure for your selected shutter speed.

4 Shoot.



- On-screen image brightness in step 3, when you pressed the shutter button halfway, may not match the brightness of your shots.
- With shutter speeds of 1.3 seconds or slower, there will be a delay before you can shoot again, as the camera processes images to reduce noise.
- Set [IS Mode] to [Off] when using a tripod or other means to secure the camera (📖59).



- If the flash fires, your shot may be overexposed. In this case, set the flash to [🚫] and shoot again (📖58).

Before Use

Basic Guide

Advanced Guide

1 Camera Basics

2 Auto Mode

3 Other Shooting Modes

4 P Mode

5 Playback Mode

6 Wi-Fi Functions

7 Setting Menu

8 Accessories

9 Appendix

Index

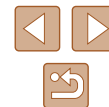

4

P Mode

More discerning shots, in your preferred shooting style

- Instructions in this chapter apply to the camera when set to **[P]** mode.
- **[P]**: Program AE; AE: Auto Exposure.
- Before using a function introduced in this chapter in modes other than **[P]**, make sure the function is available in that mode (📖134).

Shooting in Program AE ([P] Mode)

▶ Still Images ▶ Movies

You can customize many function settings to suit your preferred shooting style.



1 Enter [P] mode.

- Follow step 1 in “Specific Scenes” (📖43) and choose **[P]**.

2 Customize the settings as desired (📖50 – 📖59), and then shoot.



- If adequate exposure cannot be obtained when you press the shutter button halfway, the shutter speed and aperture value are displayed in orange. In this case, try adjusting the ISO speed (📖51) or activating the flash (if subjects are dark, 📖58), which may enable adequate exposure.
- Movies can be recorded in **[P]** mode as well, by pressing the movie button. However, some FUNC. (📖24) and MENU (📖25) settings may be automatically adjusted for movie recording.

Before Use

Basic Guide

Advanced Guide

1 Camera Basics

2 Auto Mode

3 Other Shooting Modes

4 P Mode

5 Playback Mode

6 Wi-Fi Functions

7 Setting Menu

8 Accessories

9 Appendix

Index

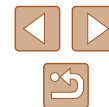

Image Brightness (Exposure)

Adjusting Image Brightness (Exposure Compensation)

► Still Images ► Movies

The standard exposure set by the camera can be adjusted in 1/3-stop increments, in a range of -2 to +2.



- Press the [▲] button. As you watch the screen, press the [◀][▶] buttons to adjust brightness.
- When shooting movies, shoot with the exposure compensation bar displayed.
- When shooting still images, press the [⊕] button to display the set exposure compensation amount, and then shoot.



- You can also shoot still images with the exposure compensation bar displayed.
- While recording a movie, [AEL] is displayed, and the exposure is locked.

Changing the Metering Method

► Still Images ► Movies

Adjust the metering method (how brightness is measured) to suit shooting conditions as follows.



- Press the [M] button, choose [M] in the menu, and choose the desired option (p.24).
- The option you configured is now displayed.

[M] Evaluative	For typical shooting conditions, including backlit shots. Automatically adjusts exposure to match the shooting conditions.
[] Center Weighted Avg.	Determines the average brightness of light across the entire image area, calculated by treating brightness in the central area as more important.
[•] Spot	Metering restricted to within the [] (Spot AE Point frame), displayed in the center of the screen.

Before Use

Basic Guide

Advanced Guide

1 Camera Basics

2 Auto Mode

3 Other Shooting Modes

4 P Mode

5 Playback Mode

6 Wi-Fi Functions

7 Setting Menu

8 Accessories

9 Appendix

Index

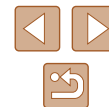

Changing the ISO Speed

► Still Images ► Movies

When the ISO speed setting is [AUTO], it is set automatically to suit the shooting mode and scene. The higher the value the ISO speed is, the greater the light sensitivity is. The lower the value the ISO speed is, the smaller the light sensitivity is.

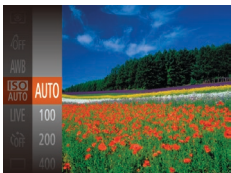

- Press the **[MENU]** button, choose **[ISO]** in the menu, and choose the desired option (📖24).
- The option you configured is now displayed.



- To view the automatically determined ISO speed when you have set the ISO speed to [AUTO], press the shutter button halfway.
- Although choosing a lower ISO speed may reduce image graininess, there may be a greater risk of subject and camera shake in some shooting conditions.
- Choosing a higher ISO speed will increase shutter speed, which may reduce subject and camera shake and increase the flash range. However, shots may look grainy.

Correcting Image Brightness (i-Contrast)

► Still Images ► Movies

Before shooting, excessively bright or dark image areas (such as faces or backgrounds) can be detected and automatically adjusted to the optimal brightness. Insufficient overall image contrast can also be automatically corrected before shooting to make subjects stand out better.



- Press the **[MENU]** button, choose **[i-Contrast]** on the **[CAMERA]** tab, and then choose **[Auto]** (📖25).
- Once the setting is complete, **[Ci]** is displayed.



- Under some shooting conditions, correction may be inaccurate or may cause images to appear grainy.



- You can also correct existing images (📖75).

Before Use

Basic Guide

Advanced Guide

1 Camera Basics

2 Auto Mode

3 Other Shooting Modes

4 P Mode

5 Playback Mode

6 Wi-Fi Functions

7 Setting Menu

8 Accessories

9 Appendix

Index

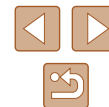
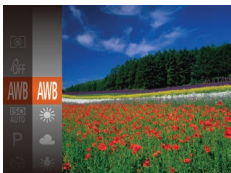

Image Colors

Adjusting White Balance

▶ Still Images ▶ Movies

By adjusting white balance (WB), you can make image colors look more natural for the scene you are shooting.



- Press the **[WB]** button, choose **[AWB]** in the menu, and choose the desired option (📖24).
- The option you configured is now displayed.

AWB	Auto	Automatically sets the optimal white balance for the shooting conditions
	Day Light	For shooting outdoors in fair weather
	Cloudy	For shooting in cloudy weather or at twilight
	Tungsten	For shooting under ordinary incandescent lighting
	Fluorescent	For shooting under white fluorescent lighting
	Fluorescent H	For shooting under daylight fluorescent lighting
	Custom	For manually setting a custom white balance (📖52)

Custom White Balance

▶ Still Images ▶ Movies

For image colors that look natural under the light in your shot, adjust white balance to suit the light source where you are shooting. Set the white balance under the same light source that will illuminate your shot.

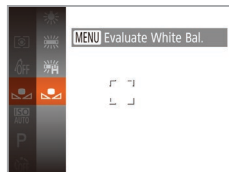

- Follow the steps in “Adjusting White Balance” (📖52) to choose **[WB]**.
- Aim the camera at a plain white subject, so that the entire screen is white. Press the **[MENU]** button.
- The tint of the screen changes once the white balance data has been recorded.



- Colors may look unnatural if you change camera settings after recording white balance data.

Changing Image Color Tones (My Colors)

▶ Still Images ▶ Movies

Change image color tones as desired, such as converting images to sepia or black and white.



- Press the **[WB]** button, choose **[My Colors]** in the menu, and choose the desired option (📖24).
- The option you configured is now displayed.

Before Use

Basic Guide

Advanced Guide

1 Camera Basics

2 Auto Mode

3 Other Shooting Modes

4 P Mode

5 Playback Mode

6 Wi-Fi Functions

7 Setting Menu

8 Accessories

9 Appendix

Index

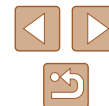

☞ My Colors Off	–
☞ Vivid	Emphasizes contrast and color saturation, making images sharper.
☞ Neutral	Tones down contrast and color saturation for subdued images.
☞ Sepia	Creates sepia tone images.
☞ B/W	Creates black and white images.
☞ Positive Film	Combines the effects of Vivid Blue, Vivid Green, and Vivid Red to produce intense yet natural-looking colors resembling images on positive film.
☞ Lighter Skin Tone	Lightens skin tones.
☞ Darker Skin Tone	Darkens skin tones.
☞ Vivid Blue	Emphasizes blues in images. Makes the sky, ocean, and other blue subjects more vivid.
☞ Vivid Green	Emphasizes greens in images. Makes mountains, foliage, and other green subjects more vivid.
☞ Vivid Red	Emphasizes reds in images. Makes red subjects more vivid.
☞ Custom Color	Adjust contrast, sharpness, color saturation, and other qualities as desired (☞53).



- White balance (☞52) cannot be set in [☞] or [☞] modes.
- With [☞] and [☞] modes, colors other than people's skin tone may change. These settings may not produce the expected results with some skin tones.

Custom Color

► Still Images ► Movies

Choose the desired level of image contrast, sharpness, color saturation, red, green, blue, and skin tones in a range of 1 – 5.

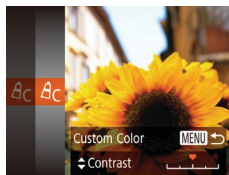

1 Access the setting screen.

- Follow the steps in “Changing Image Color Tones (My Colors)” (☞52) to choose [☞], and then press the [MENU] button.

2 Configure the setting.

- Press the [▲][▼] buttons to choose an item, and then specify the value by pressing the [◀][▶] buttons.
- For stronger/more intense effects (or darker skin tones), adjust the value to the right, and for weaker/lighter effects (or lighter skin tones), adjust the value to the left.
- Press the [MENU] button to complete the setting.

Before Use

Basic Guide

Advanced Guide

1 Camera Basics

2 Auto Mode

3 Other Shooting Modes

4 P Mode

5 Playback Mode

6 Wi-Fi Functions

7 Setting Menu

8 Accessories

9 Appendix

Index



Shooting Range and Focusing

Shooting Close-Ups (Macro)

► Still Images ► Movies

To restrict the focus to subjects at close range, set the camera to [M]. For details on the range of focus, see “Shooting Range” (142).

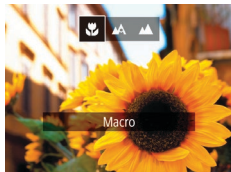

- Press the [L] button, press the [L/R] buttons to choose [M], and then press the [OK] button.
- Once the setting is complete, [M] is displayed.



- If the flash fires, vignetting may occur.
- Be careful to avoid damaging the lens.
- When the zoom position is within the range of the yellow bar below the zoom bar, [M] turns gray and the camera cannot focus.



- To prevent camera shake, try mounting the camera on a tripod and shooting with the camera set to [C] (34).

Shooting Distant Subjects (Infinity)

► Still Images ► Movies

To restrict the focus to distant subjects, set the camera to [∞]. For details on the range of focus, see “Shooting Range” (142).



- Press the [L] button, press the [L/R] buttons to choose [∞], and then press the [OK] button.
- Once the setting is complete, [∞] is displayed.

Digital Tele-Converter

► Still Images ► Movies

The focal length of the lens can be increased by approximately 1.6x or 2.0x. This can reduce camera shake because the shutter speed is faster than it would be if you zoomed (including using digital zoom) in to the same zoom factor.

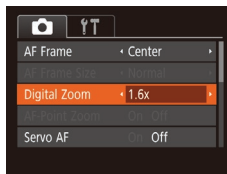

- Press the [MENU] button, choose [Digital Zoom] on the [CAMERA] tab, and then choose the desired option (25).
- The view is enlarged and the zoom factor is displayed on the screen.



- The digital tele-converter cannot be used with digital zoom (33) or AF-point zoom (39).

Before Use

Basic Guide

Advanced Guide

1 Camera Basics

2 Auto Mode

3 Other Shooting Modes

4 P Mode

5 Playback Mode

6 Wi-Fi Functions

7 Setting Menu

8 Accessories

9 Appendix

Index

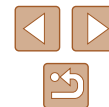



- The shutter speed may be equivalent when you move the zoom lever all the way toward for maximum telephoto, and when you zoom in to enlarge the subject to the same size following step 2 in "Zooming In Closer on Subjects (Digital Zoom)" ([33](#)).

Changing the AF Frame Mode

► Still Images ► Movies

Change the AF (auto focus) frame mode to suit the shooting conditions as follows.

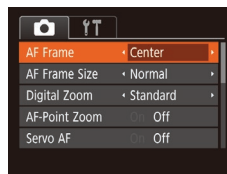

- Press the **[MENU]** button, choose [AF Frame] on the tab, and then choose the desired option ([25](#)).

Center

► Still Images ► Movies

One AF frame is displayed in the center. Effective for reliable focusing.



- A yellow AF frame is displayed with if the camera cannot focus when you press the shutter button halfway.



- To reduce the AF frame size, press the **[MENU]** button and set [AF Frame Size] on the tab to [Small] ([25](#)).
- The AF frame size is set to [Normal] when you use the digital zoom ([33](#)) or digital tele-converter ([54](#)).
- To compose shots so that subjects are positioned at the edge or in a corner, first aim the camera to capture the subject in an AF frame, and then hold the shutter button halfway down. As you continue to hold the shutter button halfway, recompose the shot as desired, and then press the shutter button all the way down (Focus Lock).
- The AF frame position is enlarged when you press the shutter button halfway with [AF-Point Zoom] ([39](#)) set to [On].

Before Use

Basic Guide

Advanced Guide

1 Camera Basics

2 Auto Mode

3 Other Shooting Modes

4 P Mode

5 Playback Mode

6 Wi-Fi Functions

7 Setting Menu

8 Accessories

9 Appendix

Index



Face AiAF

▶ Still Images ▶ Movies

- Detects people's faces, and then sets the focus, exposure (evaluative metering only), and white balance (AWB only).
- After you aim the camera at the subject, a white frame is displayed around the person's face determined by the camera to be the main subject, and up to two gray frames are displayed around other detected faces.
- When the camera detects movement, frames will follow moving subjects, within a certain range.
- After you press the shutter button halfway, up to nine green frames are displayed around faces in focus.



- If faces are not detected, or when only gray frames are displayed (without a white frame), up to nine green frames are displayed in the areas in focus when you press the shutter button halfway.
- If faces are not detected when Servo AF (p.57) is set to [On], the AF frame is displayed in the center of the screen when you press the shutter button halfway.
- Examples of faces that cannot be detected:
 - Subjects that are distant or extremely close.
 - Subjects that are dark or light.
 - Faces in profile, at an angle, or partly hidden.
- The camera may misinterpret non-human subjects as faces.
- No AF frames are displayed if the camera cannot focus when you press the shutter button halfway.

Choosing Subjects to Focus On (Tracking AF)

▶ Still Images ▶ Movies

Shoot after choosing a subject to focus on as follows.

1 Choose [Tracking AF].

- Follow the steps in “Changing the AF Frame Mode” (p.55) to choose [Tracking AF].
- [AF-ON] is displayed in the center of the screen.

2 Choose a subject to focus on.

- Aim the camera so that [AF-ON] is on the desired subject, and then press the [OK] button.



- When the subject is detected, the camera beeps and [AF-ON] is displayed. Even if the subject moves, the camera will continue to track the subject within a certain range.
- If no subject is detected, [AF-ON] is displayed.
- To cancel tracking, press the [OK] button again.

3 Shoot.

- Press the shutter button halfway. [AF-ON] changes to a blue [AF-ON], which follows the subject as the camera continues to adjust the focus and exposure (Servo AF) (p.57).
- Press the shutter button all the way down to shoot.

Before Use

Basic Guide

Advanced Guide

1 Camera Basics

2 Auto Mode

3 Other Shooting Modes

4 P Mode

5 Playback Mode

6 Wi-Fi Functions

7 Setting Menu

8 Accessories

9 Appendix

Index



- Even after your shot, [AF-ON] is still displayed and the camera continues to track the subject.



- [Servo AF] (📖57) is set to [On] and cannot be changed.
- Tracking may not be possible when subjects are too small or move too rapidly, or when subject color or brightness matches that of the background too closely.
- [AF-Point Zoom] on the [CAMERA] tab (📖25) is not available.
- [AF-ON] and [AF-LOCK] are not available.



- The camera can detect subjects even if you press the shutter button halfway without pressing the [AF-ON] button. After your shot, [AF-ON] is displayed in the center of the screen.

Shooting with Servo AF

▶ Still Images ▶ Movies

This mode helps avoid missing shots of subjects in motion, because the camera continues to focus on the subject and adjust the exposure as long as you press the shutter button halfway.

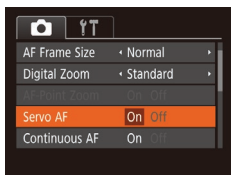

1 Configure the setting.

- Press the [MENU] button, choose [Servo AF] on the [CAMERA] tab, and then choose [On] (📖25).

2 Focus.

- The focus and exposure are maintained where the blue AF frame is displayed while you are pressing the shutter button halfway.



- Focusing may not be possible in some shooting conditions.
- In low-light conditions, Servo AF may not be activated (AF frames may not turn blue) when you press the shutter button halfway. In this case, the focus and exposure are set according to the specified AF frame mode.
- If adequate exposure cannot be obtained, the shutter speed and aperture value are displayed in orange. Release the shutter button, and then press it halfway again.
- [AF-Point Zoom] on the [CAMERA] tab (📖25) is not available.
- Not available when using the self-timer (📖34).

Changing the Focus Setting

▶ Still Images ▶ Movies

You can change default camera operation of constantly focusing on subjects it is aimed at, even when the shutter button is not pressed. Instead, you can limit camera focusing to the moment you press the shutter button halfway.



- Press the [MENU] button, choose [Continuous AF] on the [CAMERA] tab, and then choose [Off] (📖25).

On	Helps avoid missing sudden photo opportunities, because the camera constantly focuses on subjects until you press the shutter button halfway.
Off	Conserves battery power, because the camera does not focus constantly.

Before Use

Basic Guide

Advanced Guide

1 Camera Basics

2 Auto Mode

3 Other Shooting Modes

4 P Mode

5 Playback Mode

6 Wi-Fi Functions

7 Setting Menu

8 Accessories

9 Appendix

Index



Flash

Changing the Flash Mode

► Still Images ► Movies

You can change the flash mode to match the shooting scene. For details on the flash range, see “Camera” (141).

1 Lift the flash.

2 Configure the setting.

- Press the [▶] button, press the [◀][▶] buttons to choose a flash mode, and then press the [MENU] button.
- The option you configured is now displayed.



- The setting screen cannot be accessed by pressing the [▶] button when the flash is lowered. Lift the flash with your finger in advance.

Auto

Fires automatically in low-light conditions.

On

Fires for each shot.

Slow Synchro

Fires to illuminate the main subject (such as people) while shooting at a slower shutter speed to illuminate backgrounds out of flash range.



- In [🔦] mode, mount the camera on a tripod or take other measures to keep it still and prevent camera shake. Additionally, you should set [IS Mode] to [Off] when using a tripod or other means to secure the camera (159).
- In [🔦] mode, even after the flash fires, ensure that the main subject does not move until the shutter sound is finished playing.

Off

For shooting without the flash.



- A blinking [📷] icon may be displayed when you press the shutter button halfway in camera-shake inducing, low-light conditions. In this case, mount the camera on a tripod or take other measures to keep it still.

Before Use

Basic Guide

Advanced Guide

1 Camera Basics

2 Auto Mode

3 Other Shooting Modes

4 P Mode

5 Playback Mode

6 Wi-Fi Functions

7 Setting Menu

8 Accessories

9 Appendix

Index



Other Settings

Changing the Compression Ratio (Image Quality)

► Still Images ► Movies

Choose from two compression ratios, as follows. Choose from [S] (Super Fine) and [L] (Fine). For guidelines on how many shots at each compression ratio can fit on a memory card, see “Number of Shots per Memory Card” (143).



- Press the [MENU] button, choose [L] in the menu, and choose the desired option (24).

Changing the IS Mode Settings

► Still Images ► Movies

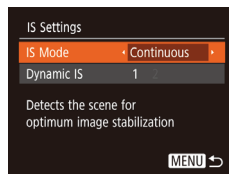

1 Access the setting screen.

- Press the [MENU] button, choose [IS Settings] on the [CAMERA] tab, and then press the [MENU] button (25).

2 Configure the setting.

- Choose [IS Mode], and then choose the desired option (25).

Continuous	Optimal image stabilization for the shooting conditions is automatically applied (Intelligent IS) (32).
Shoot Only*	Image stabilization is active only at the moment of shooting.
Off	Deactivates image stabilization.

* The setting is changed to [Continuous] for movie recording.



- If image stabilization cannot prevent camera shake, mount the camera on a tripod or take other measures to hold it still. In this case, set [IS Mode] to [Off].

Before Use

Basic Guide

Advanced Guide

1 Camera Basics

2 Auto Mode

3 Other Shooting Modes

4 P Mode

5 Playback Mode

6 Wi-Fi Functions

7 Setting Menu

8 Accessories

9 Appendix

Index



Shooting Movies with Subjects at the Same Size Shown before Shooting

▶ Still Images ▶ Movies

Normally, once movie recording begins, the image display area changes and subjects are enlarged to allow for correction of significant camera shake. To shoot subjects at the same size shown before shooting, you can choose not to reduce significant camera shake.

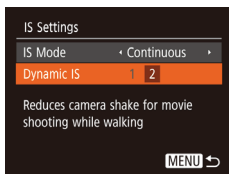

- Follow the steps in “Changing the IS Mode Settings” (📖59) to access the [IS Settings] screen.
- Choose [Dynamic IS], and then choose [2] (📖25).



- When you set the movie quality to [VGA] (📖38), it is locked at [1].
- You can also set [IS Mode] to [Off], so that subjects are recorded at the same size shown before shooting.

Before Use

Basic Guide

Advanced Guide

1 Camera Basics

2 Auto Mode

3 Other Shooting Modes

4 P Mode

5 Playback Mode

6 Wi-Fi Functions

7 Setting Menu

8 Accessories

9 Appendix

Index

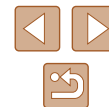

5

Playback Mode

Have fun reviewing your shots, and browse or edit them in many ways

- To prepare the camera for these operations, press the [▶] button to enter Playback mode.



- It may not be possible to play back or edit images that were renamed or already edited on a computer, or images from other cameras.

Viewing

▶ Still Images ▶ Movies

After shooting images or movies, you can view them on the screen as follows.



1 Enter Playback mode.

- Press the [▶] button.
- Your last shot is displayed.

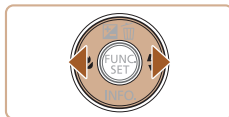

2 Choose an image.

- To view the previous image, press the [◀] button. To view the next image, press the [▶] button.

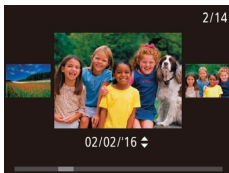

- To access this screen (Scroll Display mode), press and hold the [◀][▶] buttons for at least one second. In this mode, press the [◀][▶] buttons to browse through images.
- To return to single-image display, press the [⊞] button.
- To browse images grouped by shooting date, press the [▲][▼] buttons in Scroll Display mode.

Before Use

Basic Guide

Advanced Guide

1 Camera Basics

2 Auto Mode

3 Other Shooting Modes

4 P Mode

5 Playback Mode

6 Wi-Fi Functions

7 Setting Menu

8 Accessories

9 Appendix

Index

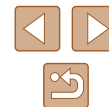



- Movies are identified by a [SET ▶] icon. To play movies, go to step 3.



3 Play movies.

- To start playback, press the [⏮] button, press the [▲][▼] buttons to choose [▶], and then press the [⏮] button again.

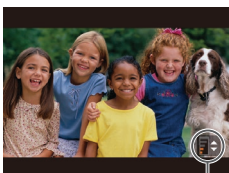

4 Adjust the volume.

- Press the [▲][▼] buttons to adjust the volume.
- To adjust the volume when the volume indicator (1) is no longer displayed, press the [▲][▼] buttons.

(1)

5 Pause playback.

- To pause or resume playback, press the [⏮] button.
- After the movie is finished, [SET ▶] is displayed.



- To switch to Shooting mode from Playback mode, press the shutter button halfway.
- To deactivate Scroll Display, choose MENU (ⓘ 25) > [▶] tab > [Scroll Display] > [Off].
- To have the most recent shot displayed when you enter Playback mode, choose MENU (ⓘ 25) > [▶] tab > [Resume] > [Last shot].
- To change the transition shown between images, access MENU (ⓘ 25) and choose your desired effect on the [▶] tab > [Transition].



Before Use
Basic Guide
Advanced Guide
1 Camera Basics
2 Auto Mode
3 Other Shooting Modes
4 P Mode
5 Playback Mode
6 Wi-Fi Functions
7 Setting Menu
8 Accessories
9 Appendix
Index



Switching Display Modes

▶ Still Images ▶ Movies

Press the [▼] button to view other information on the screen, or to hide the information. For details on the information displayed, see “Playback (Detailed Information Display)” (133).

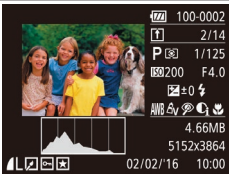
	No Information Display
	Simple Information Display
	Detailed Information Display

Overexposure Warning (for Image Highlights)

▶ Still Images ▶ Movies

Washed-out highlights in the image flash on the screen in detailed information display (63).

Histogram

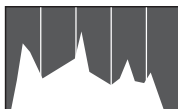

▶ Still Images ▶ Movies

- The graph in detailed information display (63) is a histogram showing the distribution of brightness in the image. The horizontal axis represents the degree of brightness, and the vertical axis, how much of the image is at each level of brightness. Viewing the histogram is a way to check exposure.

GPS Information Display

▶ Still Images ▶ Movies

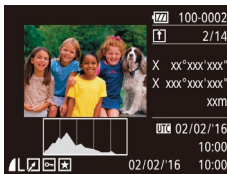

- Using a smartphone connected to the camera via Wi-Fi, you can geotag images on the camera, adding information such as latitude, longitude, and elevation (102). You can review this information in the GPS information display.
- Latitude, longitude, elevation, and UTC (shooting date and time) are listed from top to bottom.



- GPS information display is not available for images that lack this information.
- [---] is shown instead of numerical values for items not available on your smartphone or items not recorded correctly.



- UTC: Coordinated Universal Time, essentially the same as Greenwich Mean Time.

Before Use

Basic Guide

Advanced Guide

1 Camera Basics

2 Auto Mode

3 Other Shooting Modes

4 P Mode

5 Playback Mode

6 Wi-Fi Functions

7 Setting Menu

8 Accessories

9 Appendix

Index



Browsing and Filtering Images

Navigating through Images in an Index

► Still Images ► Movies

By displaying multiple images in an index, you can quickly find the images you are looking for.

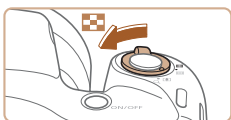

1 Display images in an index.

- Move the zoom lever toward to display images in an index. Moving the lever again will increase the number of images shown.
- To display fewer images, move the zoom lever toward . Fewer images are shown each time you move the lever.



2 Choose an image.

- Press the buttons to choose an image.
- An orange frame is displayed around the selected image.
- Press the button to view the selected image in single-image display.

Finding Images Matching Specified Conditions

► Still Images ► Movies

Find desired images quickly on a memory card full of images by filtering image display according to your specified conditions. You can also protect (67) or delete (70) these images all at once.

People	Displays images with detected faces.
Shot Date	Displays the images shot on a specific date.
Favorites	Displays images tagged as favorites (72).
Still image/ Movie	Displays only still images or movies.

1 Choose a search condition.

- Press the button, choose in the menu, and choose a condition (24).
- When you have selected or , choose the condition by pressing the buttons on the screen displayed, and then press the button.

2 View the filtered images.

- Images matching your conditions are displayed in yellow frames. To view only these images, press the buttons.
- To cancel filtered display, choose in step 1.



- When the camera has found no corresponding images for some conditions, those conditions will not be available.

Before Use

Basic Guide

Advanced Guide

1 Camera Basics

2 Auto Mode

3 Other Shooting Modes

4 P Mode

5 Playback Mode

6 Wi-Fi Functions

7 Setting Menu

8 Accessories

9 Appendix

Index





- To hide or view other information, press the [▼] button in step 2.
- Options for viewing the images found (in step 2) include “Navigating through Images in an Index” (64), “Magnifying Images” (65), and “Viewing Slideshows” (66). You can also apply image operations to all images found, by choosing [Protect All Images] in “Protecting Images” (67) or [Select All Images] in “Erasing Multiple Images at Once” (70), “Adding Images to the Print List (DPOF)” (123), or “Adding Images to a Photobook” (125).
- If you edit images and save them as new images (73 – 77), a message is displayed, and the images that were found are no longer shown.

Image Viewing Options

Magnifying Images

► Still Images ► Movies

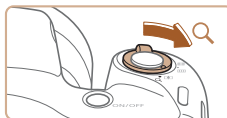

(1)

1 Magnify an image.

- Moving the zoom lever toward [Q] will zoom in and magnify the image, and [SET] is displayed. You can magnify images up to about 10x by continuing to hold the zoom lever.
- The approximate position of the displayed area (1) is shown for reference.
- To zoom out, move the zoom lever toward [Q]. You can return to single-image display by continuing to hold it.

2 Move the display position and switch images as needed.

- To move the display position, press the [▲][▼][◀][▶] buttons.
- While [SET] is displayed, you can switch to [SET] by pressing the [DISP] button. To switch to other images while zoomed, press the [◀][▶] buttons. Press the [DISP] button again to restore the original setting.



- You can return to single-image display from magnified display by pressing the [MENU] button.

Before Use

Basic Guide

Advanced Guide

1 Camera Basics

2 Auto Mode

3 Other Shooting Modes

4 P Mode

5 Playback Mode

6 Wi-Fi Functions

7 Setting Menu

8 Accessories

9 Appendix

Index



Viewing Slideshows

► Still Images ► Movies

Automatically play back images from a memory card as follows. Each image is displayed for about three seconds.



- Press the **[ON]** button, choose **[S]** in the menu, and choose the desired option (📖24).
- The slideshow will start after [Loading image] is displayed for a few seconds.
- Press the **[MENU]** button to stop the slideshow.



- The camera's power-saving functions (📖23) are deactivated during slideshows.



- To pause or resume slideshows, press the **[STOP]** button.
- You can switch to other images during playback by pressing the **[LEFT]** **[RIGHT]** buttons. For fast-forward or fast-rewind, hold the **[LEFT]** **[RIGHT]** buttons down.
- In filtered display (📖64), only images matching search conditions are played.

Changing Slideshow Settings

You can set up slideshows to repeat, and you can change the transitions between images and the display duration of each image.

1 Access the setting screen.

- Press the **[MENU]** button, and then choose [Slideshow] on the **[▶]** tab (📖25).



- [Play Time] cannot be modified when [Bubble] is chosen in [Effect].

2 Configure the settings.

- Choose a menu item to configure, and then choose the desired option (📖25).
- To start the slideshow with your settings, choose [Start] and press the **[ON]** button.
- To return to the menu screen, press the **[MENU]** button.

Auto Playback of Related Images (Smart Shuffle)

► Still Images ► Movies

Based on the current image, the camera offers four images that you may wish to view. After you choose to view one of those images, the camera offers four more images. This is an enjoyable way to play back images in an unexpected order. Try this feature after you have taken many shots, in many kinds of scenes.

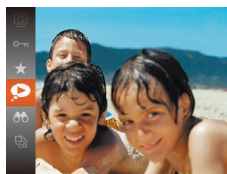

1 Choose Smart Shuffle.

- Press the **[ON]** button, and then choose **[S]** in the menu (📖24).
- Four candidate images are displayed.

Before Use

Basic Guide

Advanced Guide

1 Camera Basics

2 Auto Mode

3 Other Shooting Modes

4 P Mode

5 Playback Mode

6 Wi-Fi Functions

7 Setting Menu

8 Accessories

9 Appendix

Index

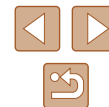



2 Choose an image.

- Press the [▲][▼][◀][▶] buttons to choose the image you want to view next.
- Your chosen image is displayed in the center, surrounded by the next four candidate images.
- For full-screen display of the center image, press the [Ⓜ] button. To restore the original display, press the [Ⓜ] button again.
- Press the [MENU] button to restore single-image display.



- Smart Shuffle is not available in the following cases:
 - There are less than 50 shots taken with this camera
 - An unsupported image is currently displayed
 - Images are shown in filtered display (📖64)

Protecting Images

▶ Still Images ▶ Movies

Protect important images to prevent accidental erasure (📖70).



- Press the [Ⓜ] button, and then choose [On] in the menu (📖24). [Protected] is displayed.
- To untag the image, repeat this process and choose [Off] again, and then press the [Ⓜ] button.



- Protected images on a memory card will be erased if you format the card (📖109, 📖110).



- Protected images cannot be erased using the camera's erasure function. To erase them this way, first cancel protection.

Before Use

Basic Guide

Advanced Guide

1 Camera Basics

2 Auto Mode

3 Other Shooting Modes

4 P Mode

5 Playback Mode

6 Wi-Fi Functions

7 Setting Menu

8 Accessories

9 Appendix

Index

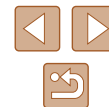

Using the Menu



1 Access the setting screen.

- Press the [MENU] button and choose [Protect] on the [▶] tab (📖25).

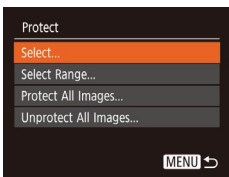

2 Choose a selection method.

- Choose a menu item and an option as desired (📖25).
- To return to the menu screen, press the [MENU] button.

Choosing Images Individually

1 Choose [Select].

- Following step 2 in “Using the Menu” (📖68), choose [Select] and press the [Ⓜ] button.



2 Choose an image.

- Press the [◀][▶] buttons to choose an image, and then press the [Ⓜ] button. [Ⓜ] is displayed.
- To untag the image, press the [Ⓜ] button again. [Ⓜ] is no longer displayed.
- Repeat this process to specify other images.

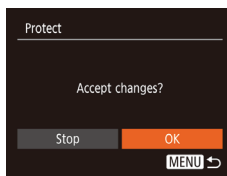

3 Protect the images.

- Press the [MENU] button. A confirmation message is displayed.
- Press the [◀][▶] buttons to choose [OK], and then press the [Ⓜ] button.



- Images will not be protected if you switch to Shooting mode or turn the camera off before finishing the setup process in step 3.

Selecting a Range

1 Choose [Select Range].

- Following step 2 in “Using the Menu” (📖68), choose [Select Range] and press the [Ⓜ] button.

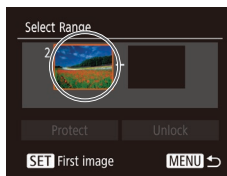

2 Choose a starting image.

- Press the [Ⓜ] button.



- Press the [◀][▶] buttons to choose an image, and then press the [Ⓜ] button.

Before Use

Basic Guide

Advanced Guide

1 Camera Basics

2 Auto Mode

3 Other Shooting Modes

4 P Mode

5 Playback Mode

6 Wi-Fi Functions

7 Setting Menu

8 Accessories

9 Appendix

Index



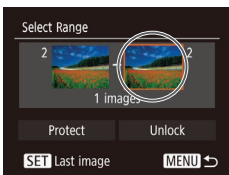

3 Choose an ending image.

- Press the [▶] button to choose [Last image], and then press the [Ⓜ] button.



- Press the [◀][▶] buttons to choose an image, and then press the [Ⓜ] button.
- Images before the first image cannot be selected as the last image.

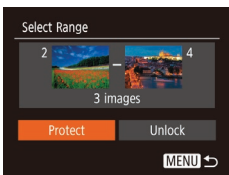

4 Protect the images.

- Press the [▼] button to choose [Protect], and then press the [Ⓜ] button.



- To cancel protection for groups of images, choose [Unlock] in step 4.

Protecting All Images at Once

1 Choose [Protect All Images].

- Following step 2 in “Using the Menu” (68), choose [Protect All Images] and press the [Ⓜ] button.

2 Protect the images.

- Press the [◀][▶] buttons to choose [OK], and then press the [Ⓜ] button.

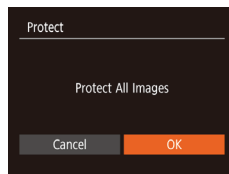

Clearing All Protection at Once

You can clear protection from all images at once. To clear protection, choose [Unprotect All Images] in step 1 of “Protecting All Images at Once”, and then complete step 2.

Before Use

Basic Guide

Advanced Guide

1 Camera Basics

2 Auto Mode

3 Other Shooting Modes

4 P Mode

5 Playback Mode

6 Wi-Fi Functions

7 Setting Menu

8 Accessories

9 Appendix

Index



Erasing Images

► Still Images ► Movies

You can choose and erase unneeded images one by one. Be careful when erasing images, because they cannot be recovered. However, protected images (📖67) cannot be erased.

1 Choose an image to erase.

- Press the [◀][▶] buttons to choose an image.



2 Erase the image.

- Press the [▲] button.
- After [Erase?] is displayed, press the [◀][▶] buttons to choose [Erase], and then press the [⊕] button.
- The current image is now erased.
- To cancel erasure, press the [◀][▶] buttons to choose [Cancel], and then press the [⊕] button.

Erasing Multiple Images at Once

You can choose multiple images to erase at once. Be careful when erasing images, because they cannot be recovered. However, protected images (📖67) cannot be erased.

Choosing a Selection Method



1 Access the setting screen.

- Press the [MENU] button, and then choose [Erase] on the [▶] tab (📖25).

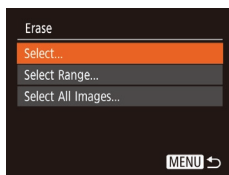

Choosing Images Individually



2 Choose a selection method.

- Press the [▲][▼] buttons to choose a selection method, and then press the [⊕] button.
- To return to the menu screen, press the [MENU] button.

1 Choose [Select].

- Following step 2 in “Choosing a Selection Method” (📖70), choose [Select] and press the [⊕] button.

2 Choose an image.

- Once you choose an image following step 2 in “Choosing Images Individually” (📖68), [✓] is displayed.
- To untag the image, press the [⊕] button again. [✓] is no longer displayed.
- Repeat this process to specify other images.

3 Erase the image.

- Press the [MENU] button. A confirmation message is displayed.
- Press the [◀][▶] buttons to choose [OK], and then press the [⊕] button.

Before Use

Basic Guide

Advanced Guide

1 Camera Basics

2 Auto Mode

3 Other Shooting Modes

4 P Mode

5 Playback Mode

6 Wi-Fi Functions

7 Setting Menu

8 Accessories

9 Appendix

Index

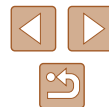

Selecting a Range

1 Choose [Select Range].

- Following step 2 in “Choosing a Selection Method” (📖70), choose [Select Range] and press the [OK] button.

2 Choose images.

- Follow steps 2 – 3 in “Selecting a Range” (📖68) to specify images.

3 Erase the image.

- Press the [▼] button to choose [Erase], and then press the [OK] button.

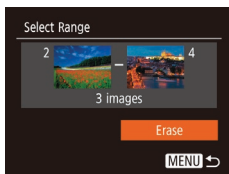

Specifying All Images at Once

1 Choose [Select All Images].

- Following step 2 in “Choosing a Selection Method” (📖70), choose [Select All Images] and press the [OK] button.

2 Erase the image.

- Press the [◀][▶] buttons to choose [OK], and then press the [OK] button.

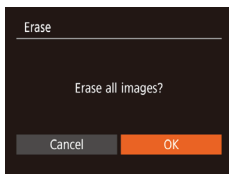

Rotating Images

► Still Images ► Movies

Change the orientation of images and save them as follows.

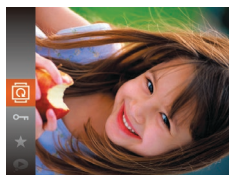

1 Choose [OK].

- Press the [OK] button, and then choose [OK] in the menu (📖24).



2 Rotate the image.

- Press the [◀] or [▶] button, depending on the desired direction. Each time you press the button, the image is rotated 90°. Press the [OK] button to complete the setting.

Using the Menu

1 Choose [Rotate].

- Press the [MENU] button and choose [Rotate] on the [📷] tab (📖25).

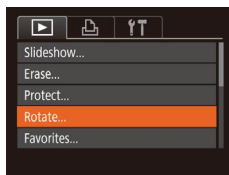

Before Use

Basic Guide

Advanced Guide

1 Camera Basics

2 Auto Mode

3 Other Shooting Modes

4 P Mode

5 Playback Mode

6 Wi-Fi Functions

7 Setting Menu

8 Accessories

9 Appendix

Index

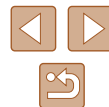



2 Rotate the image.

- Press the [◀][▶] buttons to choose an image.
- The image is rotated 90° each time you press the [⊞] button.
- To return to the menu screen, press the [MENU] button.



- Rotation is not possible when [Auto Rotate] is set to [Off] (📖72).

Deactivating Auto Rotation

Follow these steps to deactivate automatic image rotation, which rotates images based on the current camera orientation.

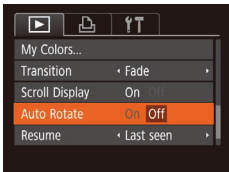

- Press the [MENU] button, choose [Auto Rotate] on the [▶] tab, and then choose [Off] (📖25).



- Images cannot be rotated (📖71) when you set [Auto Rotate] to [Off]. Additionally, images already rotated will be displayed in the original orientation.
- In Smart Shuffle (📖66) mode, even if [Auto Rotate] is set to [Off], images shot vertically will be displayed vertically, and rotated images will be displayed in the rotated orientation.

Tagging Images as Favorites

► Still Images ► Movies

You can organize images by tagging them as favorites. By choosing a category in filtered playback, you can restrict the following operations to all of those images.

- “Viewing” (📖61), “Viewing Slideshows” (📖66), “Protecting Images” (📖67), “Erasing Images” (📖70), “Adding Images to the Print List (DPOF)” (📖123), “Adding Images to a Photobook” (📖125)



- Press the [⊞] button, and then choose [★] in the menu (📖24).
- [Tagged as Favorite] is displayed.
- To untag the image, repeat this process and choose [★] again, and then press the [⊞] button.

Using the Menu

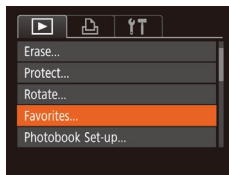

1 Choose [Favorites].

- Press the [MENU] button and choose [Favorites] on the [▶] tab (📖25).

Before Use

Basic Guide

Advanced Guide

1 Camera Basics

2 Auto Mode

3 Other Shooting Modes

4 P Mode

5 Playback Mode

6 Wi-Fi Functions

7 Setting Menu

8 Accessories

9 Appendix

Index





2 Choose an image.

- Press the [◀][▶] buttons to choose an image, and then press the [Ⓜ] button. [★] is displayed.
- To untag the image, press the [Ⓜ] button again. [★] is no longer displayed.
- Repeat this process to choose additional images.

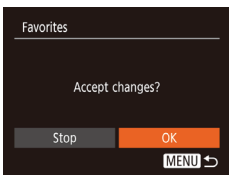

3 Configure the setting.

- Press the [MENU] button. A confirmation message is displayed.
- Press the [◀][▶] buttons to choose [OK], and then press the [Ⓜ] button.



- Images will not be tagged as favorites if you switch to Shooting mode or turn the camera off before finishing the setup process in step 3.

Editing Still Images



- Image editing (73 – 76) is only available when the memory card has sufficient free space.

Resizing Images

▶ Still Images ▶ Movies

Save a copy of images at a lower number of resolution.

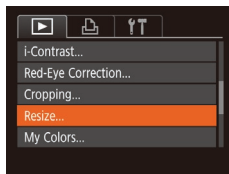

1 Choose [Resize].

- Press the [MENU] button and choose [Resize] on the [▶] tab (25).

2 Choose an image.

- Press the [◀][▶] buttons to choose an image, and then press the [Ⓜ] button.

3 Choose an image size.

- Press the [◀][▶] buttons to choose the size, and then press the [Ⓜ] button.
- [Save new image?] is displayed.

4 Save the new image.

- Press the [◀][▶] buttons to choose [OK], and then press the [Ⓜ] button.
- The image is now saved as a new file.

Before Use

Basic Guide

Advanced Guide

1 Camera Basics

2 Auto Mode

3 Other Shooting Modes

4 P Mode

5 Playback Mode

6 Wi-Fi Functions

7 Setting Menu

8 Accessories

9 Appendix

Index



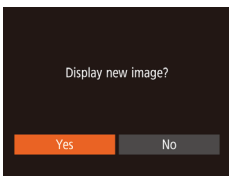

5 Review the new image.

- Press the [MENU] button. [Display new image?] is displayed.
- Press the [◀][▶] buttons to choose [Yes], and then press the [⏹] button.
- The saved image is now displayed.



- Editing is not possible for images shot at a resolution of [S] (📖37).



- Images cannot be resized to a higher resolution.

Cropping

▶ Still Images ▶ Movies

You can specify a portion of an image to save as a separate image file.

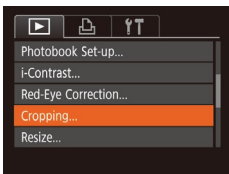

1 Choose [Cropping].

- Press the [MENU] button, and then choose [Cropping] on the [📷] tab (📖25).

2 Choose an image.

- Press the [◀][▶] buttons to choose an image, and then press the [⏹] button.

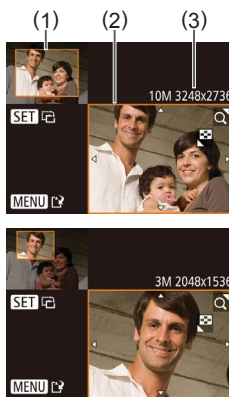

3 Adjust the cropping area.

- A frame is displayed around the portion of the image to be cropped (1).
- The original image is shown in the upper left, and a preview of the image as cropped (2) is shown in the lower right. You can also see the resolution after cropping (3).
- To resize the frame, move the zoom lever.
- To move the frame, press the [▲][▼][◀][▶] buttons.
- To change the frame orientation, press the [⏹] button.
- Press the [MENU] button.

4 Save as a new image and review.

- Follow steps 4 – 5 in “Resizing Images” (📖73).



- Editing is not possible for images shot at a resolution of [S] (📖37) or resized to [S] (📖73).



- Images supported for cropping will have the same aspect ratio after cropping.
- Cropped images will have a lower resolution than uncropped images.

Before Use
Basic Guide
Advanced Guide
1 Camera Basics
2 Auto Mode
3 Other Shooting Modes
4 P Mode
5 Playback Mode
6 Wi-Fi Functions
7 Setting Menu
8 Accessories
9 Appendix
Index

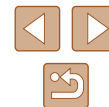

Changing Image Color Tones (My Colors)

► Still Images ► Movies

You can adjust image colors and then save the edited image as a separate file. For details on each option, see “Changing Image Color Tones (My Colors)” (📖52).

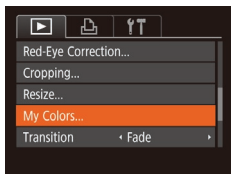

1 Choose [My Colors].

- Press the [MENU] button, and then choose [My Colors] on the [▶] tab (📖25).

2 Choose an image.

- Press the [◀][▶] buttons to choose an image, and then press the [📷] button.

3 Choose an option.

- Press the [◀][▶] buttons to choose an option, and then press the [📷] button.

4 Save as a new image and review.

- Follow steps 4 – 5 in “Resizing Images” (📖73).



- Image quality of pictures you repeatedly edit this way will be a little lower each time, and you may not be able to obtain the desired color.



- The color of images edited using this function may vary slightly from the color of images shot using My Colors (📖52).

Correcting Image Brightness (i-Contrast)

► Still Images ► Movies

Excessively dark image areas (such as faces or backgrounds) can be detected and automatically adjusted to the optimal brightness. Insufficient overall image contrast is also automatically corrected, to make subjects stand out better. Choose from four correction levels, and then save the image as a separate file.

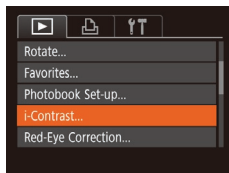

1 Choose [i-Contrast].

- Press the [MENU] button, and then choose [i-Contrast] on the [▶] tab (📖25).

2 Choose an image.

- Press the [◀][▶] buttons to choose an image, and then press the [📷] button.

3 Choose an option.

- Press the [◀][▶] buttons to choose an option, and then press the [📷] button.

4 Save as a new image and review.

- Follow steps 4 – 5 in “Resizing Images” (📖73).



- For some images, correction may be inaccurate or may cause images to appear grainy.
- Images may look grainy after repeated editing using this function.



- If [Auto] does not produce the expected results, try correcting images using [Low], [Medium], or [High].

Before Use

Basic Guide

Advanced Guide

1 Camera Basics

2 Auto Mode

3 Other Shooting Modes

4 P Mode

5 Playback Mode

6 Wi-Fi Functions

7 Setting Menu

8 Accessories

9 Appendix

Index



Correcting Red-Eye

► Still Images ► Movies

Automatically corrects images affected by red-eye. You can save the corrected image as a separate file.

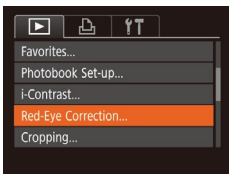

1 Choose [Red-Eye Correction].

- Press the [MENU] button, and then choose [Red-Eye Correction] on the [REDA] tab (📖25).

2 Choose an image.

- Press the [◀][▶] buttons to choose an image.

3 Correct the image.

- Press the [⊕] button.
- Red-eye detected by the camera is now corrected, and frames are displayed around corrected image areas.
- Enlarge or reduce images as needed. Follow the steps in “Magnifying Images” (📖65).

4 Save as a new image and review.

- Press the [▲][▼][◀][▶] buttons to choose [New File], and then press the [⊕] button.
- The image is now saved as a new file.
- Follow step 5 in “Resizing Images” (📖73).

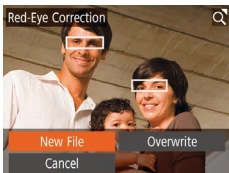

- Some images may not be corrected accurately.
- To overwrite the original image with the corrected image, choose [Overwrite] in step 4. In this case, the original image will be erased.
- Protected images cannot be overwritten.

Before Use

Basic Guide

Advanced Guide

1 Camera Basics

2 Auto Mode

3 Other Shooting Modes

4 P Mode

5 Playback Mode

6 Wi-Fi Functions

7 Setting Menu

8 Accessories

9 Appendix

Index



Editing Movies

► Still Images ► Movies

You can remove unneeded portions from the beginning and end of movies.

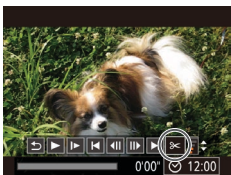

1 Choose [C].

- Following steps 1 – 5 in “Viewing” (61), choose [C] and press the [OK] button.
- The movie editing panel and editing bar are now displayed.

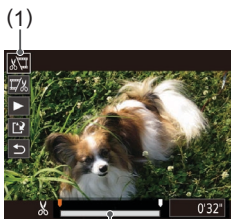

2 Specify portions to cut.

- (1) is the movie editing panel, and (2) is the editing bar.
- Press the [▲][▼] buttons to choose [L] or [R].
- To view the portions you can cut (identified by [L] on the screen), press the [◀][▶] buttons to move [I]. Cut the beginning of the movie (from [L]) by choosing [L], and cut the end of the movie by choosing [R].
- If you move [I] to a position other than a [L] mark, in [L] the portion before the nearest [L] mark on the left will be cut, while in [R] the portion after the nearest [L] mark on the right will be cut.

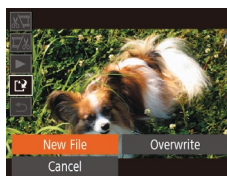

3 Review the edited movie.

- Press the [▲][▼] buttons to choose [▶], and then press the [OK] button. The edited movie is now played.
- To edit the movie again, repeat step 2.
- To cancel editing, press the [▲][▼] buttons to choose [S]. Press the [OK] button, press the [◀][▶] buttons to choose [OK], and then press the [OK] button again.

4 Save the edited movie.

- Press the [▲][▼] buttons to choose [L], and then press the [OK] button.
- Press the [▲][▼][◀][▶] buttons to choose [New File], and then press the [OK] button.
- The movie is now saved as a new file.



- To overwrite the original movie with the cut one, choose [Overwrite] in step 4. In this case, the original movie will be erased.
- If the memory card lacks sufficient space, only [Overwrite] will be available.
- Movies may not be saved if the battery pack runs out while saving is in progress.
- When editing movies, you should use a fully charged battery pack.

Before Use

Basic Guide

Advanced Guide

1 Camera Basics

2 Auto Mode

3 Other Shooting Modes

4 P Mode

5 Playback Mode

6 Wi-Fi Functions

7 Setting Menu

8 Accessories

9 Appendix

Index



6

Wi-Fi Functions

Send images wirelessly from the camera to a variety of compatible devices, and use the camera with Web services



- Before using Wi-Fi, be sure to read "Wi-Fi (Wireless LAN) Precautions" (147).

Available Wi-Fi Features

You can send and receive images and control the camera remotely by connecting it to these devices and services via Wi-Fi.

- **Smartphones and Tablets**
Send images to smartphones and tablet computers that have Wi-Fi functions. You can also shoot remotely and geotag your shots from a smartphone or tablet.
For convenience in this manual, smartphones, tablets, and other compatible devices are collectively referred to as "smartphones".
- **Computer**
Use software to save camera images to a computer connected via Wi-Fi.
- **Web Services**
Add your account information to the camera for CANON iMAGE GATEWAY online photography service or other Web services to send camera images to the services. Unsent images on the camera can also be sent to a computer or Web service via CANON iMAGE GATEWAY.
- **Printers**
Send images wirelessly to a PictBridge-compatible printer (supporting DPS over IP) to print them.
- **Another Camera**
Send images wirelessly between Wi-Fi compatible Canon cameras.

Before Use

Basic Guide

Advanced Guide

1 Camera Basics

2 Auto Mode

3 Other Shooting Modes

4 P Mode

5 Playback Mode

6 Wi-Fi Functions

7 Setting Menu

8 Accessories

9 Appendix

Index



Sending Images to a Smartphone

There are several ways to connect the camera to a smartphone and send images.

- Connect via NFC (📖79)
Simply touch an NFC-compatible Android smartphone (OS version 4.0 or later) against the camera to connect the devices
- Use the Wi-Fi menu to connect (📖82)
You can connect the camera to a smartphone as you would connect it to a computer or other device. Multiple smartphones can be added.

Before connecting to the camera, you must install the free dedicated Camera Connect app on the smartphone. For details on this application (supported smartphones and included functions), refer to the Canon website.



- If you own a Wi-Fi compatible Canon camera and your camera and smartphone are connected to Wi-Fi, it is recommended that you change the app that you use on your smartphone from "CameraWindow" to "Camera Connect".

Sending Images to an NFC-Compatible Smartphone

Using an NFC-compatible Android smartphone (OS version 4.0 or later) simplifies the process of installing Camera Connect and connecting the devices via NFC.

Operation once the devices are connected via NFC varies depending on the camera mode when the devices are touched together.

- If the camera is off or in Shooting mode when the devices are touched together, you can choose and send images on the image selection screen. Once the devices are connected, you can also shoot remotely and geotag your shots (📖102). It's easy to reconnect to recent devices, which are listed in the Wi-Fi menu.
- When you touch the smartphone in Playback mode, the screen with a list of images that you can choose to send is displayed. Choose an image to send it.

Follow the instructions in the following section for NFC-initiated connection to a camera that is off or in Shooting mode.

Connecting via NFC When Camera Is Off or in Shooting Mode

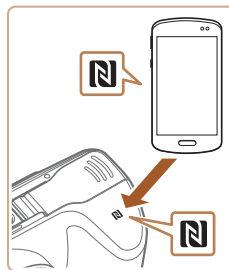

1 Install Camera Connect.

- Activate NFC on the smartphone and touch the device against the camera's N-Mark (N) to start Google Play on the smartphone automatically. Once the Camera Connect download page is displayed, download and install the app.

Before Use

Basic Guide

Advanced Guide

1 Camera Basics

2 Auto Mode

3 Other Shooting Modes

4 P Mode

5 Playback Mode

6 Wi-Fi Functions

7 Setting Menu

8 Accessories

9 Appendix

Index



2 Establish the connection.

- Make sure the camera is off or in Shooting mode.
- Touch the N-Mark (N) on the smartphone with Camera Connect installed against the camera's N-Mark.
- The camera starts up automatically.
- After the [Device Nickname] screen is displayed, press the [▲][▼] buttons to choose [OK], and then press the [MENU] button.
- Camera Connect is started on the smartphone.
- The devices are connected automatically.

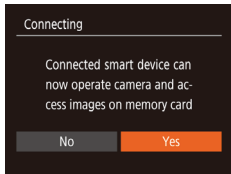
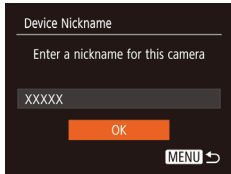

3 Adjust the privacy setting.

- After this screen is displayed, press the [◀][▶] buttons to choose [Yes], and then press the [MENU] button.
- You can now use the smartphone to browse, import, or geotag images on the camera or shoot remotely.

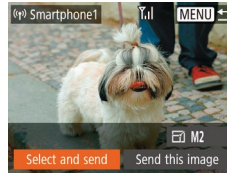

4 Send images.

- Press the [▲][▼][◀][▶] buttons to choose [Select and send], and then press the [MENU] button.
- Press the [▲][▼] buttons to choose [Select], and then press the [MENU] button.
- Press the [▲][▼][◀][▶] buttons to choose an image to send, press the [MENU] button to mark it as selected ([✓]), and then press the [MENU] button.
- Press the [◀][▶] buttons to choose [OK], and then press the [MENU] button.
- Press the [▲][▼][◀][▶] buttons to choose [Send], and then press the [MENU] button.
- [Transfer completed] is displayed after the image is sent, and the image transfer screen is displayed again.
- To end the connection, press the [MENU] button, press the [◀][▶] buttons on the confirmation screen to choose [OK], and then press the [MENU] button. You can also use the smartphone to end the connection.

Before Use

Basic Guide

Advanced Guide

1 Camera Basics

2 Auto Mode

3 Other Shooting Modes

4 P Mode

5 Playback Mode

6 Wi-Fi Functions

7 Setting Menu

8 Accessories

9 Appendix

Index

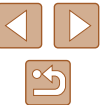



- When using NFC, keep the following points in mind.
 - Avoid strong impact between the camera and smartphone. This may damage the devices.
 - Depending on the smartphone, the devices may not recognize each other immediately. In this case, try holding the devices together in slightly different positions. If connection is not established, keep the devices together until the camera screen is updated.
 - If you try to connect while the camera is off, a message will be displayed on your smartphone to ask you to turn the camera on. Touch and try again after the camera is turned on.
 - Do not place other objects between the camera and smartphone. Also, note that camera or smartphone covers or similar accessories may block communication.
- All images in the camera can be viewed from the connected smartphone when you choose [Yes] in step 3. To keep camera images private, so that they cannot be viewed from the smartphone, choose [No] in step 3.
- Once you have registered a smartphone, you can change privacy settings for it on the camera (103).



- Connections require that a memory card be in the camera.
- You can change the nickname of the camera displayed on the screen of step 2 (80).
- Not all NFC-compatible smartphones have an N-Mark (N). For details, refer to the smartphone user manual.
- You can also send multiple images at once and change the image size before sending (97).
- You can send the current image by choosing [Send this image] on the screen in step 4.
- To disable NFC connections, choose MENU (25) > [NFC] tab > [Wireless settings] > [Wi-Fi Settings] > [NFC] > [Off].

Connecting via NFC When Camera Is in Playback Mode



- Press the [▶] button to turn the camera on.
- Touch the N-Mark (N) on the smartphone (79) with Camera Connect installed against the camera's N-Mark.
- Press the [▲][▼][◀][▶] buttons to choose an image to send, and then press the [☑] button. [✓] is displayed.
- To untag the image, press the [☑] button again. [✓] is no longer displayed.
- Repeat this process to choose additional images.
- After you finish choosing images, press the [MENU] button.
- Press the [◀][▶] buttons to choose [OK], and then press the [☑] button.
- Press the [▲][▼][◀][▶] buttons to choose [Send], and then press the [☑] button.
- The images are sent.



- If a message is displayed on the camera and requests you to enter the nickname during connection, follow step 2 in "Sending Images to an NFC-Compatible Smartphone" (79) to enter it.
- The camera does not keep a record of smartphones you connect to via NFC in Playback mode.
- You can preset images to transfer at your desired size (97).

Before Use

Basic Guide

Advanced Guide

1 Camera Basics

2 Auto Mode

3 Other Shooting Modes

4 P Mode

5 Playback Mode

6 Wi-Fi Functions

7 Setting Menu

8 Accessories

9 Appendix

Index



Adding a Smartphone

These steps show how to use the camera as an access point, but you can also use an existing access point (📖84).



1 Install Camera Connect.

- For an iPhone and iPad, find Camera Connect in the App Store and download and install the app.
- For Android smartphones, find Camera Connect in Google Play and download and install the app.

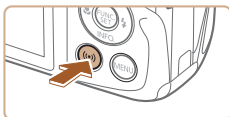

2 Access the Wi-Fi menu.

- Press the [Wi-Fi] button.
- If the [Device Nickname] screen is displayed, choose [OK] (📖80).

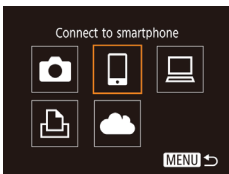

3 Choose [📱].

- Press the [▲][▼][◀][▶] buttons to choose [📱], and then press the [📶] button.

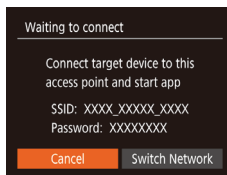
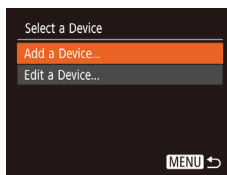

4 Choose [Add a Device].

- Press the [▲][▼] buttons to choose [Add a Device], and then press the [📶] button.

- The camera's SSID and password are displayed.

5 Connect the smartphone to the network.

- In the smartphone's Wi-Fi setting menu, choose the SSID (network name) displayed on the camera to establish a connection.
- In the password field, enter the password displayed on the camera.

6 Start Camera Connect.

- Start Camera Connect on the smartphone.

Before Use

Basic Guide

Advanced Guide

1 Camera Basics

2 Auto Mode

3 Other Shooting Modes

4 P Mode

5 Playback Mode

6 Wi-Fi Functions

7 Setting Menu

8 Accessories

9 Appendix

Index

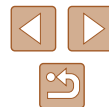

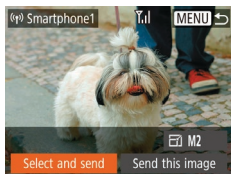
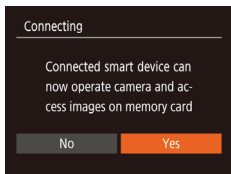

7 Choose the camera to connect.

- When the screen for choosing the target camera is displayed on your smartphone, choose the camera to pair them.

8 Adjust the privacy setting.

- Press the [◀][▶] buttons to choose [Yes], and then press the [OK] button.
- You can now use the smartphone to browse, import, or geotag images on the camera or shoot remotely.

9 Send images.

- Press the [▲][▼][◀][▶] buttons to choose [Select and send], and then press the [OK] button.
- Press the [▲][▼] buttons to choose [Select], and then press the [OK] button.
- Press the [▲][▼][◀][▶] buttons to choose an image to send, press the [OK] button to mark it as selected ([✓]), and then press the [MENU] button.
- Press the [◀][▶] buttons to choose [OK], and then press the [OK] button.
- Press the [▲][▼][◀][▶] buttons to choose [Send], and then press the [OK] button.
- [Transfer completed] is displayed after the image is sent, and the image transfer screen is displayed again.
- To end the connection, press the [MENU] button, press the [◀][▶] buttons on the confirmation screen to choose [OK], and then press the [OK] button. You can also use the smartphone to end the connection.

- To add multiple smartphones, repeat the above procedure starting from step 1.



- All images in the camera can be viewed from the connected smartphone when you choose [Yes] in step 8. To keep camera images private, so that they cannot be viewed from the smartphone, choose [No] in step 8.
- Once you have registered a smartphone, you can change privacy settings for it on the camera (103).



- Connections require that a memory card be in the camera.
- Once you have connected to devices via the Wi-Fi menu, recent destinations will be listed first when you access the Wi-Fi menu. You can easily connect again by pressing the [▲][▼] buttons to choose the device and then pressing the [OK] button. To add a new device, display the device selection screen by pressing the [◀][▶] buttons, and then configure the setting.
- If you prefer not to display recent target devices, choose MENU (25) > [Wi-Fi] tab > [Wireless settings] > [Wi-Fi Settings] > [Target History] > [Off].
- To be able to connect without entering the password in step 5 and to make it so that [Password] does not display on the SSID display screen (step 4), choose MENU (25) > [Wi-Fi] tab > [Wireless settings] > [Wi-Fi Settings] > [Password] > [Off].
- You can also send multiple images at once and change the image size before sending (97).
- You can send the current image by choosing [Send this image] on the screen in step 9.

Before Use

Basic Guide

Advanced Guide

1 Camera Basics

2 Auto Mode

3 Other Shooting Modes

4 P Mode

5 Playback Mode

6 Wi-Fi Functions

7 Setting Menu

8 Accessories

9 Appendix

Index

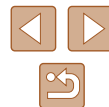

Using Another Access Point

When connecting the camera to a smartphone through the Wi-Fi menu, you can also use an existing access point.



1 Prepare for the connection.

- Access the [Waiting to connect] screen by following steps 1 – 4 in “Adding a Smartphone” (82).

2 Connect the smartphone to the access point.

3 Choose [Switch Network].

- Press the [◀][▶] buttons to choose [Switch Network], and then press the [Ⓜ] button.
- A list of detected access points will be displayed.

4 Connect to the access point.

- For WPS-compatible access points, connect to the access point and choose the smartphone as described in steps 5 – 8 in “Using WPS-Compatible Access Points” (87).
- For non-WPS access points, follow steps 2 – 4 in “Connecting to Listed Access Points” (89) to connect to the access point and choose the smartphone.

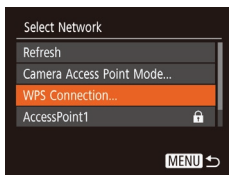
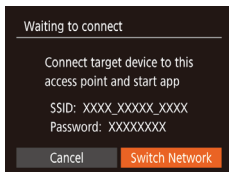

5 Configure the privacy settings and send images.

- Follow steps 8 – 9 in “Adding a Smartphone” (82) to configure the privacy settings and send images.

Previous Access Points

You can reconnect to any previous access points automatically by following step 4 in “Adding a Smartphone” (82).

- To use the camera as an access point, choose [Switch Network] on the screen displayed when you establish a connection, and then choose [Camera Access Point Mode].
- To switch access points, choose [Switch Network] on the screen displayed when you establish a connection, and then follow the procedure in “Using Another Access Point” (84) from step 4.

Before Use

Basic Guide

Advanced Guide

1 Camera Basics

2 Auto Mode

3 Other Shooting Modes

4 P Mode

5 Playback Mode

6 Wi-Fi Functions

7 Setting Menu

8 Accessories

9 Appendix

Index

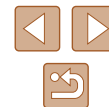

Saving Images to a Computer

Preparing to Register a Computer

For detailed system requirements, such as about computers that can connect to the camera and Wi-Fi, and compatibility information, including support in new operating systems, visit the Canon website.



- Windows 7 Starter and Home Basic editions are not supported.
- Windows 7 N (European version) and KN (South Korean version) require a separate download and installation of Windows Media Feature Pack.

For details, check the following website.

<http://go.microsoft.com/fwlink/?LinkId=159730>

Installing the Software

Windows 7 and Mac OS X 10.8 are used here for the sake of illustration.

1 Download the software.

- With a computer connected to the Internet, access the following website.

<http://www.canon.com/icpd/>

- Choose the country/area where you live, and then follow the on-screen instructions to download the software.
- The software will be downloaded to your computer in a zipped format.



2 Install the software.

- Double-click the downloaded file and the screen on the left is displayed. Click [Easy Installation] and follow the on-screen instructions to complete the installation process.
- Installation may take some time, depending on computer performance and the Internet connection.
- Click [Finish] or [Restart] on the screen after installation.



- Internet access is required, and any ISP account charges and access fees must be paid separately.



- Use the following procedure to uninstall (delete) the software.
 - If using Windows, click the [Start] menu ► [All Programs] ► [Canon Utilities], and choose the software that you want to uninstall.
 - If using Mac OS, click the [Applications] folder ► [Canon Utilities], and then move the folder of the software that you want to uninstall to the Trash. Empty the Trash.

Configuring the Computer for a Wi-Fi Connection (Windows Only)

On a computer running Windows, configure the following settings before connecting the camera to the computer wirelessly.



1 Confirm that the computer is connected to an access point.

- For instructions on checking your network connection, refer to the computer user manual.

Before Use

Basic Guide

Advanced Guide

1 Camera Basics

2 Auto Mode

3 Other Shooting Modes

4 P Mode

5 Playback Mode

6 Wi-Fi Functions

7 Setting Menu

8 Accessories

9 Appendix

Index



2 Configure the setting.

- Click in the following order: [Start] menu ▶ [All Programs] ▶ [Canon Utilities] ▶ [CameraWindow] ▶ [Wi-Fi connection setup].
- In the application that opens, follow the on-screen instructions and configure the setting.



- The following Windows settings are configured when you run the utility in step 2.
 - Turn on media streaming
This will enable the camera to see (find) the computer to access via Wi-Fi.
 - Turn on network discovery
This will enable the computer to see (find) the camera.
 - Turn on ICMP (Internet Control Message Protocol)
This allows you to check the network connection status.
 - Enable Universal Plug & Play (UPnP)
This will enable network devices to detect each other automatically.
- Some security software may prevent you from completing the settings as described here. Check the settings of your security software.

Saving Images to a Connected Computer

Connect to your access point via Wi-Fi as follows.
Also refer to the access point user manual.

Confirming Access Point Compatibility

Confirm that the Wi-Fi router or base station conforms to the Wi-Fi standards in “Camera” (141).

Connection methods vary depending on whether the access point supports Wi-Fi Protected Setup (WPS, 87) or not (89). For non-WPS access points, check the following information.

- Network name (SSID/ESSID)
The SSID or ESSID for the access point you use. Also called the “access point name” or “network name”.
- Network authentication / data encryption (encryption method / encryption mode)
The method for encrypting data during wireless transmission. Check which security setting is used: WPA2-PSK (AES), WPA2-PSK (TKIP), WPA-PSK (AES), WPA-PSK (TKIP), WEP (open system authentication), or no security.
- Password (encryption key / network key)
The key used when encrypting data during wireless transmission. Also called the “encryption key” or “network key”.
- Key index (transmit key)
The key set when WEP is used for network authentication / data encryption. Use “1” as the setting.



- If system administrator status is needed to adjust network settings, contact the system administrator for details.
- These settings are very important for network security. Exercise adequate caution when changing these settings.

Before Use

Basic Guide

Advanced Guide

1 Camera Basics

2 Auto Mode

3 Other Shooting Modes

4 P Mode

5 Playback Mode

6 Wi-Fi Functions

7 Setting Menu

8 Accessories

9 Appendix

Index





- For information on WPS compatibility and for instructions on checking settings, refer to the access point user manual.
- A router is a device that creates a network (LAN) structure for connecting multiple computers. A router that contains an internal Wi-Fi function is called a “Wi-Fi router”.
- This guide refers to all Wi-Fi routers and base stations as “access points”.
- If you use MAC address filtering on your Wi-Fi network, be sure to add the camera’s MAC address to your access point. You can check your camera’s MAC address by choosing MENU (25) > [Wi-Fi Settings] > [Check MAC Address].

Using WPS-Compatible Access Points

WPS makes it easy to complete settings when connecting devices over Wi-Fi. You can use either Push Button Configuration Method or PIN Method for settings on a WPS supported device.

1 Confirm that the computer is connected to an access point.

- For instructions on checking the connection, refer to the device and access point user manuals.

2 Access the Wi-Fi menu.

- Press the [WPS] button.

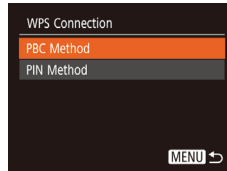
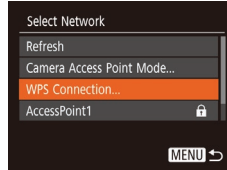
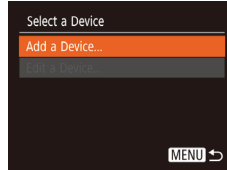
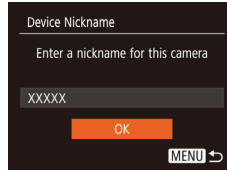

- After the [Device Nickname] screen is displayed, press the [▲][▼] buttons to choose [OK], and then press the [WPS] button.

3 Choose [Laptop].

- Press the [▲][▼][◀][▶] buttons to choose [Laptop], and then press the [WPS] button.

4 Choose [Add a Device].

- Press the [▲][▼] buttons to choose [Add a Device], and then press the [WPS] button.

5 Choose [WPS Connection].

- Press the [▲][▼] buttons to choose [WPS Connection], and then press the [WPS] button.

6 Choose [PBC Method].

- Press the [▲][▼] buttons to choose [PBC Method], and then press the [WPS] button.

Before Use

Basic Guide

Advanced Guide

1 Camera Basics

2 Auto Mode

3 Other Shooting Modes

4 P Mode

5 Playback Mode

6 Wi-Fi Functions

7 Setting Menu

8 Accessories

9 Appendix

Index

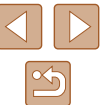

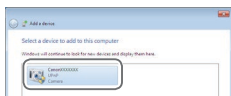
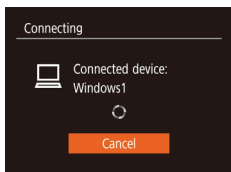
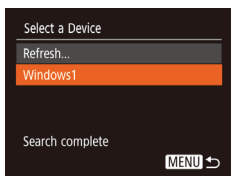
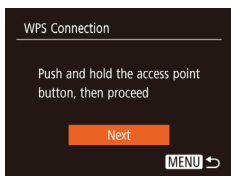

7 Establish the connection.

- On the access point, hold down the WPS connection button for a few seconds.
- On the camera, press the button to go to the next step.
- The camera connects to the access point and lists devices connected to it on the [Select a Device] screen.

8 Choose the target device.

- Press the buttons to choose the target device name, and then press the button.

9 Install a driver (first Windows connection only).

- When this screen is displayed on the camera, click the Start menu on the computer, click [Control Panel], and then click [Add a device].
- Double-click the connected camera icon.
- Driver installation will begin.
- After driver installation is complete, and the camera and computer connection is enabled, the AutoPlay screen will be displayed. Nothing will be displayed on the camera screen.

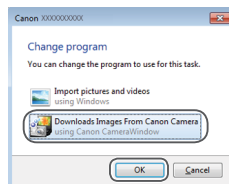

10 Display CameraWindow.

- Windows: Access CameraWindow by clicking [Downloads Images From Canon Camera].
- Mac OS: CameraWindow is automatically displayed when a Wi-Fi connection is established between the camera and computer.

11 Import images.

- Click [Import Images from Camera], and then click [Import Untransferred Images].
- Images are now saved to the Pictures folder on the computer, in separate folders named by date.
- Click [OK] in the screen that is displayed after image import is complete.
- To look at a image saved on your computer, use a software (such as one installed on your computer by default or general software) that supports images shot with a camera.

Before Use
Basic Guide
Advanced Guide
1 Camera Basics
2 Auto Mode
3 Other Shooting Modes
4 P Mode
5 Playback Mode
6 Wi-Fi Functions
7 Setting Menu
8 Accessories
9 Appendix
Index





- Once you have connected to devices via the Wi-Fi menu, recent destinations will be listed first when you access the Wi-Fi menu. You can easily connect again by pressing the [▲][▼] buttons to choose the device and then pressing the [ⓘ] button. To add a new device, display the device selection screen by pressing the [◀][▶] buttons, and then configure the setting.
- If you prefer not to display recent target devices, choose MENU (📖25) > [↑] tab > [Wireless settings] > [Wi-Fi Settings] > [Target History] > [Off].
- You can change the nickname of the camera displayed on the screen of step 2 (📖87).
- When the camera is connected to a computer, the camera screen is blank.
- Mac OS: If CameraWindow is not displayed, click the [CameraWindow] icon in the Dock.
- To disconnect from the camera, turn off the camera.
- If you chose [PIN Method] in step 6, a PIN code will be displayed on the screen. Be sure to set this code in the access point. Choose a device in the [Select a Device] screen. For further details, refer to the user manual included with your access point.

Connecting to Listed Access Points

1 View the listed access points.

- View the listed networks (access points) as described in steps 1 – 4 of “Using WPS-Compatible Access Points” (📖87).

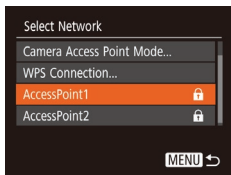

2 Choose an access point.

- Press the [▲][▼] buttons to choose a network (access point), and then press the [ⓘ] button.

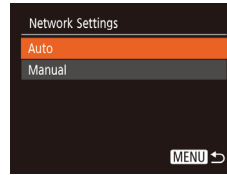

- To determine the access point password, check on the access point itself or refer to the user manual.
- If no access points are detected even after you choose [Refresh] in step 2 to update the list, choose [Manual Settings] in step 2 to complete access point settings manually. Follow on-screen instructions and enter an SSID, security settings, and a password.
- When you use an access point that you have already connected to for connecting to another device, [*] is displayed for the password in step 3. To use the same password, press the [▲][▼] buttons to choose [Next], and then press the [ⓘ] button.

3 Enter the access point password.

- Press the [ⓘ] button to access the keyboard, and then enter the password (📖26).
- Press the [▲][▼] buttons to choose [Next], and then press the [ⓘ] button.

4 Choose [Auto].

- Press the [▲][▼] buttons to choose [Auto], and then press the [ⓘ] button.
- To save images to a connected computer, follow the procedure from step 8 in “Using WPS-Compatible Access Points” (📖87).

Before Use
Basic Guide
Advanced Guide
1 Camera Basics
2 Auto Mode
3 Other Shooting Modes
4 P Mode
5 Playback Mode
6 Wi-Fi Functions
7 Setting Menu
8 Accessories
9 Appendix
Index

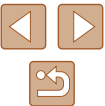

Previous Access Points

You can reconnect to any previous access points automatically by following step 4 in “Using WPS-Compatible Access Points” (87).

- To reconnect to the access point, confirm that the target device is already connected to it, and then follow the procedure from step 8 in “Using WPS-Compatible Access Points” (87).
- To switch access points, choose [Switch Network] on the screen displayed when you establish a connection, and then either follow the procedure in “Using WPS-Compatible Access Points” (87) from step 5 or the procedure in “Connecting to Listed Access Points” (89) from step 2.

Sending Images to a Registered Web Service

Registering Web Services

Use a smartphone or computer to add to the camera Web services that you want to use.

- A smartphone or computer with a browser and Internet connection is required to complete camera settings for CANON iMAGE GATEWAY and other Web services.
- Check the CANON iMAGE GATEWAY website for details on browser (Microsoft Internet Explorer, etc.) requirements, including settings and version information.
- For information on countries and regions where CANON iMAGE GATEWAY is available, visit the Canon website (<http://www.canon.com/cig/>).
- You must have an account with Web services other than CANON iMAGE GATEWAY if you desire to use them. For further details, check the websites for each Web service you want to register.
- Separate ISP connection and access point fees may be applicable.



- You can also download the user manual from CANON iMAGE GATEWAY.

Before Use

Basic Guide

Advanced Guide

1 Camera Basics

2 Auto Mode

3 Other Shooting Modes

4 P Mode

5 Playback Mode

6 Wi-Fi Functions

7 Setting Menu

8 Accessories

9 Appendix

Index



Registering CANON iIMAGE GATEWAY

To link the camera and CANON iIMAGE GATEWAY, add CANON iIMAGE GATEWAY as a destination Web service on the camera. By setting this, an e-mail notification for Camera Web Link Settings will be sent, so you must use the e-mail address that you use on your computer or smartphone.

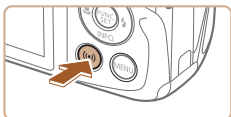

1 Access the Wi-Fi menu.

- Press the [**Wi-Fi**] button.

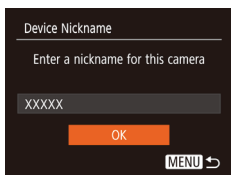

- After the [Device Nickname] screen is displayed, press the [**▲**][**▼**] buttons to choose [OK], and then press the [**⊞**] button.

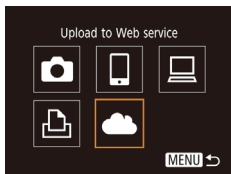

2 Choose [**Cloud**].

- Press the [**▲**][**▼**][**◀**][**▶**] buttons to choose [**Cloud**], and then press the [**⊞**] button.

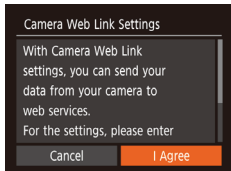

3 Consent to entering your e-mail address.

- Read the displayed content, press the [**◀**][**▶**] buttons to choose [I Agree], and then press the [**⊞**] button.

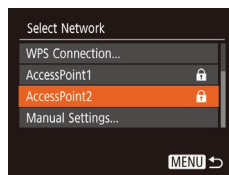

4 Establish a connection with an access point.

- Connect to the access point as described in steps 5 – 7 in “Using WPS-Compatible Access Points” (87) or in steps 2 – 4 in “Connecting to Listed Access Points” (89).

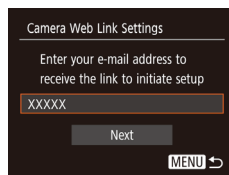

5 Enter your e-mail address.

- Once the camera is connected to CANON iIMAGE GATEWAY via the access point, a screen is displayed for entering an e-mail address.
- Enter your e-mail address, press the [**▲**][**▼**] buttons to choose [Next], and then press the [**⊞**] button.

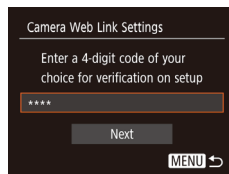

6 Enter a four-digit number.

- Enter any four-digit number, press the [**▲**][**▼**] buttons to choose [Next], and then press the [**⊞**] button.
- You will need this four-digit number later when setting up linkage with CANON iIMAGE GATEWAY in step 8.

Before Use

Basic Guide

Advanced Guide

1 Camera Basics

2 Auto Mode

3 Other Shooting Modes

4 P Mode

5 Playback Mode

6 Wi-Fi Functions

7 Setting Menu

8 Accessories

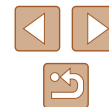

9 Appendix

Index

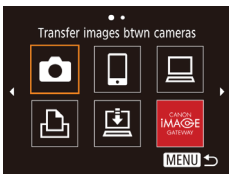
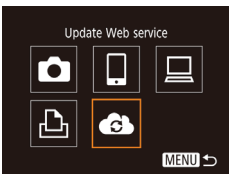
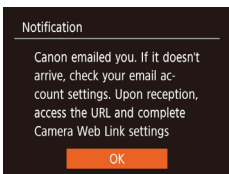









7 Confirm the e-mail notification was sent.

- When information is sent from CANON iMAGE GATEWAY, an e-mail notification is sent to the e-mail address you entered in step 5.
- The screen notifying you that the e-mail notification was sent is displayed. Press the  button.
- The  icon changes to .

8 Access the URL in the received e-mail notification and set the camera web link.

- From a computer or smartphone, access the page linked in the notification message.
- Follow the directions on the Camera Web Link Settings page to configure the settings.



9 Set CANON iMAGE GATEWAY on the camera.

- Press the  buttons to choose , and then press the  button.
-  (p.99) and CANON iMAGE GATEWAY are now added as destinations.
- You can also add other Web services. To add other Web services, follow the procedure in “Registering Other Web Services” (p.92) from step 2.



- Depending on your e-mail settings on your computer or smartphone, e-mail from specific domains may be rejected, and you may not be able to receive the e-mail notification. Please check your settings ahead of time.



- You can change the nickname of the camera displayed on the screen of step 1 (p.91).
- Once you have connected to devices via the Wi-Fi menu, recent destinations will be listed first when you access the menu. Press the  buttons to access the device selection screen and then configure the setting.

Registering Other Web Services

You can also add Web services besides CANON iMAGE GATEWAY to the camera.



1 Log in to CANON iMAGE GATEWAY and access the Camera Web Link Settings page.

- From a computer or smartphone, access <http://www.canon.com/cig/> to visit CANON iMAGE GATEWAY.

2 Configure the Web service you want to use.

- Using your computer or smartphone, display the Web service settings screen.
- Follow the instructions displayed on the screen to set up the Web service.

Before Use

Basic Guide

Advanced Guide

1 Camera Basics

2 Auto Mode

3 Other Shooting Modes

4 P Mode

5 Playback Mode

6 Wi-Fi Functions

7 Setting Menu

8 Accessories

9 Appendix

Index

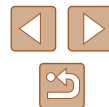

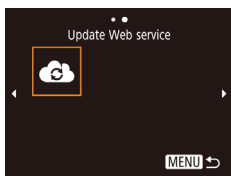

3 Choose [Cloud].

- Press the [Wi-Fi] button.
- Press the [▲][▼][◀][▶] buttons to choose [Cloud], and then press the [OK] button.
- The Web service settings are now updated.



- If any configured settings change, follow these steps again to update the camera settings.

Uploading Images to Web Services

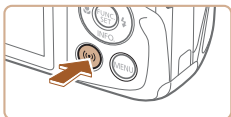

1 Access the Wi-Fi menu.

- Press the [Wi-Fi] button.



2 Choose the destination.

- Press the [▲][▼][◀][▶] buttons to choose the icon of the Web service to connect to, and then press the [OK] button.
- If multiple recipients or sharing options are used with a Web service, choose the desired item on the [Select Recipient] screen by pressing the [▲][▼] buttons, and then press the [OK] button.

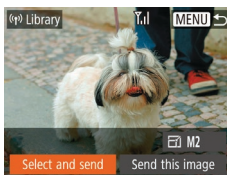

3 Send images.

- Press the [▲][▼][◀][▶] buttons to choose [Select and send], and then press the [OK] button.
- Press the [▲][▼] buttons to choose [Select], and then press the [OK] button.
- Press the [▲][▼][◀][▶] buttons to choose an image to send, press the [OK] button to mark it as selected ([✓]), and then press the [MENU] button.
- Press the [◀][▶] buttons to choose [OK], and then press the [OK] button.
- Press the [▲][▼][◀][▶] buttons to choose [Send], and then press the [OK] button.
- When uploading to YouTube, read the terms of service, choose [I Agree], and press the [OK] button.
- After the image is sent, [OK] is displayed on the screen. Press the [OK] button to return to the playback screen.



- Connections require that a memory card with saved images be in the camera.
- You can also send multiple images at once, resize images, and add comments before sending (p. 97).
- You can send the current image by choosing [Send this image] on the screen in step 3.
- To look at images sent to CANON IMAGE GATEWAY from your smartphone, it is recommended that you use the specialized application Canon Online Photo Album. For iPhone and iPad, find Canon Online Photo Album in the App Store and download and install the app. For Android smartphones, find Canon Online Photo Album in Google Play and download and install the app.

Before Use

Basic Guide

Advanced Guide

1 Camera Basics

2 Auto Mode

3 Other Shooting Modes

4 P Mode

5 Playback Mode

6 Wi-Fi Functions

7 Setting Menu

8 Accessories

9 Appendix

Index



Printing Images Wirelessly from a Connected Printer

Connect the camera to a printer via Wi-Fi to print as follows. These steps show how to use the camera as an access point, but you can also use an existing access point (84).

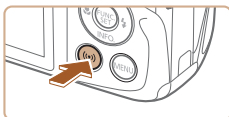

1 Access the Wi-Fi menu.

- Press the [Wi-Fi] button.



2 Choose [Print].

- Press the [Up][Down][Left][Right] buttons to choose [Print], and then press the [OK] button.

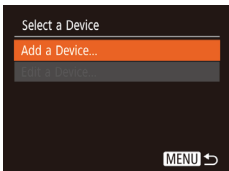

3 Choose [Add a Device].

- Press the [Up][Down] buttons to choose [Add a Device], and then press the [OK] button.

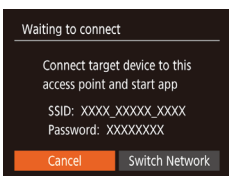

- The camera's SSID and password are displayed.

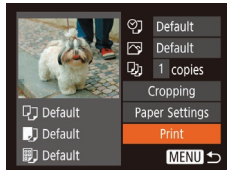
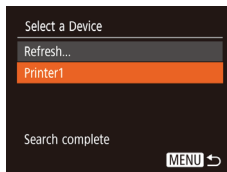

4 Connect the printer to the network.

- In the printer's Wi-Fi setting menu, choose the SSID (network name) displayed on the camera to establish a connection.
- In the password field, enter the password displayed on the camera.

5 Choose the printer.

- Press the [Up][Down] buttons to choose the printer name, and then press the [OK] button.

6 Choose an image to print.

- Press the [Left][Right] buttons to choose an image.
- Press the [OK] button, choose [Print], and press the [OK] button again.
- Press the [Up][Down] buttons to choose [Print], and then press the [OK] button.
- For detailed printing instructions, see "Printing Images" (119).
- To end the connection, press the [Up] button, press the [Left][Right] buttons on the confirmation screen to choose [OK], and then press the [OK] button.

Before Use
Basic Guide
Advanced Guide
1 Camera Basics
2 Auto Mode
3 Other Shooting Modes
4 P Mode
5 Playback Mode
6 Wi-Fi Functions
7 Setting Menu
8 Accessories
9 Appendix
Index





- Connections require that a memory card with saved images be in the camera.
- Once you have connected to devices via the Wi-Fi menu, recent destinations will be listed first when you access the Wi-Fi menu. You can easily connect again by pressing the [▲][▼] buttons to choose the device and then pressing the [Ⓜ] button. To add a new device, display the device selection screen by pressing the [◀][▶] buttons, and then configure the setting.
- If you prefer not to display recent target devices, choose MENU (M) > [↑][↓] tab > [Wireless settings] > [Wi-Fi Settings] > [Target History] > [Off].
- To be able to connect without entering the password in step 4 and to make it so that [Password] does not display on the SSID display screen (step 3), choose MENU (M) > [↑][↓] tab > [Wireless settings] > [Wi-Fi Settings] > [Password] > [Off].
- To use another access point, follow steps 3 – 4 in “Using Another Access Point” (84).

Sending Images to Another Camera

Connect two cameras via Wi-Fi and send images between them as follows.

- Only Canon-brand cameras equipped with a Wi-Fi function can be connected to wirelessly. You cannot connect to a Canon-brand camera that does not have a Wi-Fi function, even if it supports FlashAir/Eye-Fi cards.

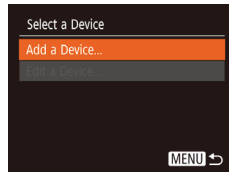
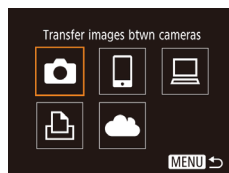
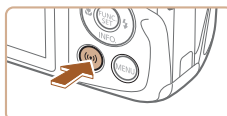

1 Access the Wi-Fi menu.

- Access the Wi-Fi menu as described in step 2 in “Adding a Smartphone” (82).

2 Choose [Camera].

- Press the [▲][▼][◀][▶] buttons to choose [Camera], and then press the [Ⓜ] button.

3 Choose [Add a Device].

- Press the [▲][▼] buttons to choose [Add a Device], and then press the [Ⓜ] button.
- Follow steps 1 – 3 on the target camera too.
- Camera connection information will be added when [Start connection on target camera] is displayed on both camera screens.

Before Use

Basic Guide

Advanced Guide

1 Camera Basics

2 Auto Mode

3 Other Shooting Modes

4 P Mode

5 Playback Mode

6 Wi-Fi Functions

7 Setting Menu

8 Accessories

9 Appendix

Index



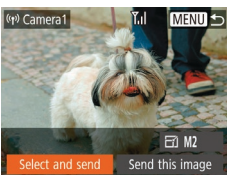

4 Send images.

- Press the [▲][▼][◀][▶] buttons to choose [Select and send], and then press the [⊕] button.
- Press the [▲][▼] buttons to choose [Select], and then press the [⊕] button.
- Press the [▲][▼][◀][▶] buttons to choose an image to send, press the [⊕] button to mark it as selected ([✓]), and then press the [MENU] button.
- Press the [◀][▶] buttons to choose [OK], and then press the [⊕] button.
- Press the [▲][▼][◀][▶] buttons to choose [Send], and then press the [⊕] button.
- [Transfer completed] is displayed after the image is sent, and the image transfer screen is displayed again.
- To end the connection, press the [MENU] button, press the [◀][▶] buttons on the confirmation screen to choose [OK], and then press the [⊕] button.



- Connections require that a memory card be in the camera.
- Once you have connected to devices via the Wi-Fi menu, recent destinations will be listed first when you access the Wi-Fi menu. You can easily connect again by pressing the [▲][▼] buttons to choose the device and then pressing the [⊕] button. To add a new device, display the device selection screen by pressing the [◀][▶] buttons, and then configure the setting.
- If you prefer not to display recent target devices, choose MENU (p. 25) > [Wi-Fi] tab > [Wireless settings] > [Wi-Fi Settings] > [Target History] > [Off].
- You can also send multiple images at once and change the image size before sending (p. 97).
- You can send the current image by choosing [Send this image] on the screen in step 4.

Before Use
Basic Guide
Advanced Guide
1 Camera Basics
2 Auto Mode
3 Other Shooting Modes
4 P Mode
5 Playback Mode
6 Wi-Fi Functions
7 Setting Menu
8 Accessories
9 Appendix
Index

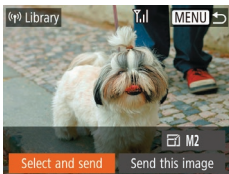

Image Sending Options

You can choose multiple images to send at once and change the image resolution (size) before sending. Some Web services also enable you to annotate the images you send.

Sending Multiple Images

On the image transfer screen, you can select a range of images to send, and send images tagged as favorites.



1 Choose [Select and send].

- On the image transfer screen, press the [◀][▶] buttons to choose [Select and send], and then press the [⊕] button.

2 Choose a selection method.

- Press the [▲][▼] buttons to choose a selection method.

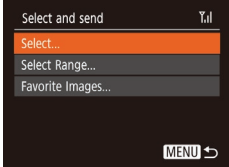

Selecting a Range

1 Choose [Select Range].

- Following step 2 in “Sending Multiple Images” (📖97), choose [Select Range] and press the [⊕] button.

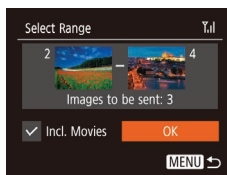

2 Choose images.

- Follow steps 2 – 3 in “Selecting a Range” (📖68) to specify images.
- When sending movies as well, press the [▲][▼][◀][▶] buttons to choose [Incl. Movies], and then press [⊕] to add [✓].
- Press the [▲][▼][◀][▶] buttons to choose [OK], and then press the [⊕] button.

3 Send the image.

- Press the [◀][▶] buttons to choose [Send], and then press the [⊕] button.

Sending Images Tagged as Favorites

You can send images tagged as favorites (📖72).

1 Choose [Favorite Images].

- Following step 2 in “Sending Multiple Images” (📖97), choose [Favorite Images] and press the [⊕] button.
- The image selection screen that displays only favorite images is displayed. To make it so that an image is not sent, after choosing an image, press [⊕] to remove [✓].
- Press the [MENU] button.
- Press the [◀][▶] buttons to choose [OK], and then press the [⊕] button.

2 Send the image.

- Press the [◀][▶] buttons to choose [Send], and then press the [⊕] button.



- If you have no images tagged as favorite, you cannot choose [Favorite Images] in step 1.

Before Use

Basic Guide

Advanced Guide

1 Camera Basics

2 Auto Mode

3 Other Shooting Modes

4 P Mode

5 Playback Mode

6 Wi-Fi Functions

7 Setting Menu

8 Accessories

9 Appendix

Index



Notes on Sending Images

- Depending on the condition of the network you are using, it may take a long time to send movies. Be sure to keep an eye on the camera battery level.
- Web services may limit the number of images or length of movies you can send.
- When sending movies to smartphones, note that the supported image quality varies depending on the smartphone. For details, refer to the smartphone user manual.
- On the screen, wireless signal strength is indicated by the following icons.
[📶] high, [📶] medium, [📶] low, [📶] weak
- Sending images to Web services will take less time when resending images you have already sent that are still on the CANON iMAGE GATEWAY server.

Choosing the Number of Recording Pixels (Image Size)

On the image transfer screen, choose [📷] by pressing the [▲][▼] buttons, and then press the [⊕] button. On the screen displayed, choose the resolution (image size) by pressing the [▲][▼] buttons, and then press the [⊕] button.

- To send images at original size, select [No] as the resizing option.
- By choosing [M2], you can resize images that are larger than the selected size before sending.
- Movies cannot be resized.



- Image size can also be configured in MENU (📖25) > [📷] tab > [Wireless settings] > [Wi-Fi Settings] > [Resize for Sending].

Before Use

Basic Guide

Advanced Guide

1 Camera Basics

2 Auto Mode

3 Other Shooting Modes

4 P Mode

5 Playback Mode

6 Wi-Fi Functions

7 Setting Menu

8 Accessories

9 Appendix

Index



Adding Comments

Using the camera, you can add comments to images that you send to e-mail addresses, social networking services, etc. The number of characters and symbols that can be entered may differ depending on the Web service.

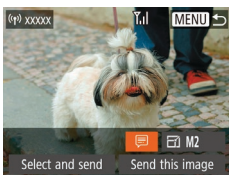

1 Access the screen for adding comments.

- On the image transfer screen, choose [] by pressing the [▲][▼][◀][▶] buttons, and then press the [] button.

2 Add a comment (26).

3 Send the image.



- When a comment is not entered, the comment set in CANON iIMAGE GATEWAY is automatically sent.
- You can also annotate multiple images before sending them. The same comment is added to all images sent together.

Sending Images Automatically (Image Sync)

Images on the memory card that have not been transferred already can be sent to a computer or Web services via CANON iIMAGE GATEWAY. Note that images cannot be sent only to Web services.

Initial Preparations

■ Preparing the Camera

Register [] as the destination. On the destination computer, install and set up the Image Sync software “ImageTransfer Utility” (free).



1 Add [] as a destination.

- Add [] as a destination, as described in “Registering CANON iIMAGE GATEWAY” (91).
- When sending images to the Web Service as well, log in to CANON iIMAGE GATEWAY (91). After choosing the camera model, display the Web Service settings screen. Under Image Sync settings, choose the Web service that you want to send the images to. For details, see the CANON iIMAGE GATEWAY Help.

Before Use

Basic Guide

Advanced Guide

1 Camera Basics

2 Auto Mode

3 Other Shooting Modes

4 P Mode

5 Playback Mode

6 Wi-Fi Functions

7 Setting Menu

8 Accessories

9 Appendix

Index



2 Choose the type of images to send (only when sending movies with images).

- Press the [MENU] button, choose [Wireless settings] on the [Wi-Fi] tab, and then choose [Wi-Fi Settings] (p.25).
- Press the [▲][▼] buttons to choose [Image Sync], and then press the [◀][▶] buttons to choose [Stills/Movies].

■ Preparing the Computer

Install and configure the software on the destination computer.



1 Install Image Transfer Utility.

- Install Image Transfer Utility on a computer connected to the Internet (p.117).
- You can download the Image Transfer Utility from the CANON iMAGE GATEWAY Image Sync setting screen (p.91).

2 Register the camera.

- Windows: In the taskbar, right-click [i], and then click [Add new camera].
- Mac OS: In the menu bar, click [i], and then click [Add new camera].
- A list of cameras linked to CANON iMAGE GATEWAY is displayed. Choose the camera from which images are to be sent.

- Once the camera is registered and the computer is ready to receive images, the icon changes to [i].

Sending Images

Images sent from the camera are automatically saved to the computer. If the computer that you intend to send images to is turned off, the images will be stored temporarily on the CANON iMAGE GATEWAY server. Stored images are regularly erased, so make sure to turn on the computer and save the images.

1 Send images.

- Following steps 1 – 2 in “Uploading Images to Web Services” (p.93), choose [i].
- Images labeled with a [i] icon have been transferred.

2 Save the images to the computer.

- Images are automatically saved to the computer when you turn it on.
- Images are automatically sent to Web services from the CANON iMAGE GATEWAY server, even if the computer is off.



- When sending images, you should use a fully charged battery pack.

Before Use
Basic Guide
Advanced Guide
1 Camera Basics
2 Auto Mode
3 Other Shooting Modes
4 P Mode
5 Playback Mode
6 Wi-Fi Functions
7 Setting Menu
8 Accessories
9 Appendix
Index





- Even if images were imported to the computer through a different method, any images not sent to the computer via CANON iMAGE GATEWAY will be sent to the computer.
- Sending is faster when the destination is a computer on the same network as the camera, because images are sent via the access point instead of CANON iMAGE GATEWAY. Note that images stored on the computer are sent to CANON iMAGE GATEWAY, so the computer must be connected to the Internet.

Viewing Images Sent via Image Sync on Your Smartphone

When you install Canon Online Photo Album (Canon OPA) on your smartphone, you can see and download images transferred with Image Sync and temporarily saved on CANON iMAGE GATEWAY. The following preparations are required in advance.

- You must finish the setup process for “Preparing the Computer” (100).
- For iPhone and iPad, find Canon Online Photo Album in the App Store and download and install the app. For Android smartphones, find Canon Online Photo Album in Google Play and download and install the app.
- Log in to CANON iMAGE GATEWAY (91). After choosing the camera model, display the Web Service settings screen. Under Image Sync settings, change the settings so that you can view and download on your smartphone. For details, see the CANON iMAGE GATEWAY Help.



- After a fixed period of time, you will not be able to view images deleted from CANON iMAGE GATEWAY.
- To view sent images, you must first set Image Sync settings so that you can view and download images on your smartphone.



- For information on Canon Online Photo Album operations, see the Canon Online Photo Album Help.

Before Use

Basic Guide

Advanced Guide

1 Camera Basics

2 Auto Mode

3 Other Shooting Modes

4 P Mode

5 Playback Mode

6 Wi-Fi Functions

7 Setting Menu

8 Accessories

9 Appendix

Index



Using a Smartphone to View Camera Images and Control the Camera

You can do the following with the dedicated smartphone app Camera Connect.

- Browse images on the camera and save them to the smartphone
- Geotag images on the camera (📖102)
- Shoot remotely (📖102)



- Privacy settings must be configured in advance to allow image viewing on the smartphone (📖82, 📖103).

Geotagging Images on the Camera

GPS data recorded on a smartphone using the dedicated Camera Connect application can be added to images on the camera. Images are tagged with information including the latitude, longitude, and elevation.



- Before shooting, make sure the date and time and your home time zone are set correctly, as described in “Setting the Date and Time” (📖17). Also follow the steps in “World Clock” (📖107) to specify any shooting destinations in other time zones.
- Others may be able to locate or identify you by using location data in your geotagged still images or movies. Be careful when sharing these images with others, as when posting images online where many others can view them.

Shooting Remotely

As you check a shooting screen on your smartphone, you can use it to shoot remotely.

1 Secure the camera.

- Once remote shooting begins, the camera lens will come out. Lens motion from zooming may also move the camera out of position. Keep the camera still by mounting it on a tripod or taking other measures.

2 Connect the camera and smartphone (📖82).

- In the privacy settings, choose [Yes].

3 Choose remote shooting.

- In Camera Connect on the smartphone, choose remote shooting.
- The camera lens will come out. Do not press near the lens, and make sure no objects will obstruct it.
- Once the camera is ready for remote shooting, a live image from the camera will be displayed on the smartphone.
- At this time, a message is displayed on the camera, and all operations except pressing the ON/OFF button are disabled.

4 Shoot.

- Use the smartphone to shoot.

Before Use

Basic Guide

Advanced Guide

1 Camera Basics

2 Auto Mode

3 Other Shooting Modes

4 P Mode

5 Playback Mode

6 Wi-Fi Functions

7 Setting Menu

8 Accessories

9 Appendix

Index





- The camera works in [P] mode during remote shooting. However, some FUNC. and MENU settings you have configured in advance may be changed automatically.
- Movie shooting is not available.



- Any jerky subject motion shown on the smartphone due to the connection environment will not affect recorded images.
- No AF frames are displayed. Capture a test image to check the focus.
- Captured images are not transferred to the smartphone. Use the smartphone to browse and import images from the camera.

Editing or Erasing Wi-Fi Settings

Edit or erase Wi-Fi settings as follows.

Editing Connection Information

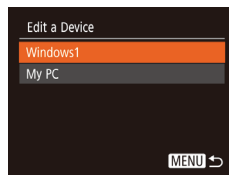
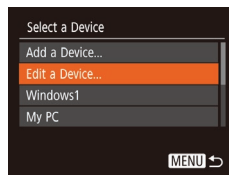
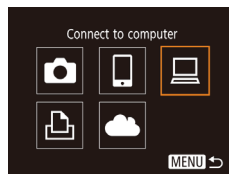

1 Access the Wi-Fi menu and choose a device to edit.

- Press the [(P)] button.
- Press the [▲][▼][◀][▶] buttons to choose the icon of a device to edit, and then press the [MENU] button.

2 Choose [Edit a Device].

- Press the [▲][▼] buttons to choose [Edit a Device], and then press the [MENU] button.

3 Choose the device to edit.

- Press the [▲][▼] buttons to choose the device to edit, and then press the [MENU] button.

4 Choose the item to edit.

- Press the [▲][▼] buttons to choose the item to edit, and then press the [MENU] button.
- The items you can change depend on the device or service.

Before Use

Basic Guide

Advanced Guide

1 Camera Basics

2 Auto Mode

3 Other Shooting Modes

4 P Mode

5 Playback Mode

6 Wi-Fi Functions

7 Setting Menu

8 Accessories

9 Appendix

Index



Configurable Items	Connection				
					Web Services
[Change Device Nickname] (📖104)	○	○	○	○	–
[View Settings] (📖82)	–	○	–	–	–
[Erase Connection Info] (📖104)	○	○	○	○	–

○ : Configurable – : Not configurable

Changing a Device Nickname

You can change the device nickname (display name) that is displayed on the camera.

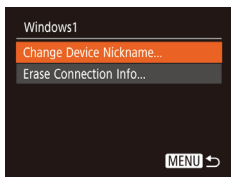

- Following step 4 in “Editing Connection Information” (📖103), choose [Change Device Nickname] and press the [MENU] button.
- Select the input field and press the [MENU] button. Use the keyboard displayed to enter a new nickname (📖26).

Erasing Connection Information

Erase connection information (information about devices that you have connected to) as follows.

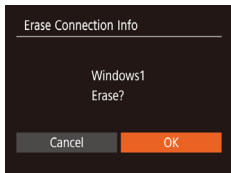

- Following step 4 in “Editing Connection Information” (📖103), choose [Erase Connection Info] and press the [MENU] button.
- After [Erase?] is displayed, press the [←][→] buttons to choose [OK], and then press the [MENU] button.
- The connection information will be erased.

Changing the Camera Nickname

You can change the nickname of the camera displayed on the connected device.

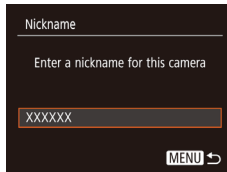
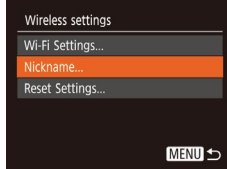
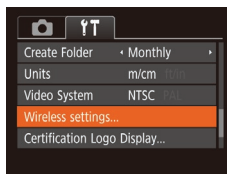

1 Choose [Wireless settings].

- Press the [MENU] button and choose [Wireless settings] on the [↑] tab (📖25).

2 Choose [Nickname].

- Press the [▲][▼] buttons to choose [Nickname], and then press the [MENU] button.

3 Change the device nickname.

- Press the [MENU] button. Use the keyboard displayed to enter a new nickname (📖26).



- A message is displayed if the nickname you enter begins with a symbol or space. Press the [MENU] button and enter a different nickname.
- On the [Device Nickname] screen displayed when using the Wi-Fi function for the first time, choose the field and press [MENU] to display the keyboard. You can then enter a nickname.

Before Use

Basic Guide

Advanced Guide

1 Camera Basics

2 Auto Mode

3 Other Shooting Modes

4 P Mode

5 Playback Mode

6 Wi-Fi Functions

7 Setting Menu

8 Accessories

9 Appendix

Index

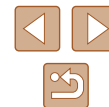

Returning the Wi-Fi Settings to Default

Return the Wi-Fi settings to default if you transfer ownership of the camera to another person, or dispose of it.

Resetting the Wi-Fi settings will also clear all Web service settings. Be sure that you want to reset all Wi-Fi settings before using this option.

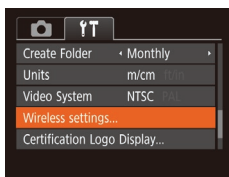

1 Choose [Wireless settings].

- Press the [MENU] button and choose [Wireless settings] on the [Wi-Fi] tab (📖25).

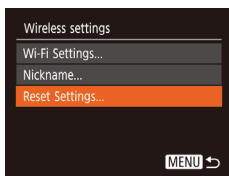

2 Choose [Reset Settings].

- Press the [▲][▼] buttons to choose [Reset Settings], and then press the [OK] button.

3 Restore the default settings.

- Press the [◀][▶] buttons to choose [OK], and then press the [OK] button.
- The Wi-Fi settings are now reset.



- To reset other settings (aside from Wi-Fi) to defaults, choose [Reset All] on the [Wi-Fi] tab (📖112).

Before Use

Basic Guide

Advanced Guide

1 Camera Basics

2 Auto Mode

3 Other Shooting Modes

4 P Mode

5 Playback Mode

6 Wi-Fi Functions

7 Setting Menu

8 Accessories

9 Appendix

Index

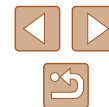

7

Setting Menu

Customize or adjust basic camera functions for greater convenience

Adjusting Basic Camera Functions

Basic camera functions are configured on the **[Fn]** tab of the MENU **[M]** (25). Customize commonly used functions as desired, for greater convenience.

Silencing Camera Operations

Silence camera sounds and movies as follows.

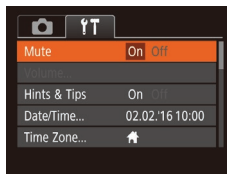

- Choose [Mute], and then choose [On].



- Operation can also be silenced by holding down the **[▼]** button as you turn the camera on.
- Sound is not played during movies **[M]** (61) if you mute camera sounds. To restore sound during movies, press the **[▲]** button. Adjust volume with the **[▲]**/**[▼]** buttons, as needed.

Adjusting the Volume

Adjust the volume of individual camera sounds as follows.

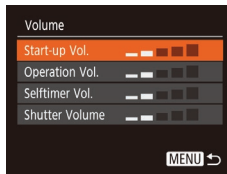

- Choose [Volume], and then press the **[M]** button.
- Choose an item, and then press the **[◀]**/**[▶]** buttons to adjust the volume.

Before Use

Basic Guide

Advanced Guide

1 Camera Basics

2 Auto Mode

3 Other Shooting Modes

4 P Mode

5 Playback Mode

6 Wi-Fi Functions

7 Setting Menu

8 Accessories

9 Appendix

Index

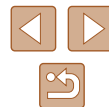

Hiding Hints and Tips

Hints and tips are normally shown when you choose FUNC. (📖24) or MENU (📖25) items. If you prefer, you can deactivate this information.

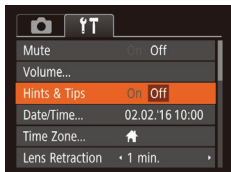

- Choose [Hints & Tips], and then choose [Off].

Date and Time

Adjust the date and time as follows.

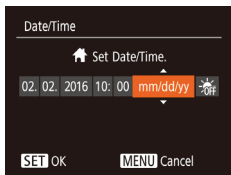

- Choose [Date/Time], and then press the [⏸] button.
- Press the [◀][▶] buttons to choose an option, and then press the [▲][▼] buttons to adjust the setting.

World Clock

To ensure that your shots will have the correct local date and time when you travel abroad, simply register the destination in advance and switch to that time zone. This convenient feature eliminates the need to change the Date/Time setting manually.

Before using the world clock, be sure to set the date and time and your home time zone, as described in “Setting the Date and Time” (📖17).

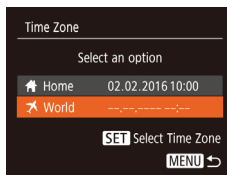

1 Specify your destination.

- Choose [Time Zone], and then press the [⏸] button.
- Press the [▲][▼] buttons to choose [✈ World], and then press the [⏸] button.
- Press the [◀][▶] buttons to choose the destination.
- To set daylight saving time (1 hour ahead), choose [☀] by pressing the [▲][▼] buttons, and then choose [☀] by pressing the [◀][▶] buttons.
- Press the [⏸] button.

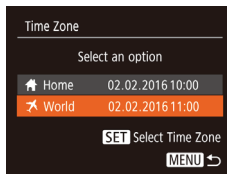

2 Switch to the destination time zone.

- Press the [▲][▼] buttons to choose [✈ World], and then press the [MENU] button.
- [✈] is now shown on the shooting screen (📖132).



- Adjusting the date or time while in [✈] mode (📖17) will automatically update your [🏠 Home] time and date.

Before Use

Basic Guide

Advanced Guide

1 Camera Basics

2 Auto Mode

3 Other Shooting Modes

4 P Mode

5 Playback Mode

6 Wi-Fi Functions

7 Setting Menu

8 Accessories

9 Appendix

Index

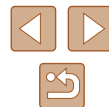

Lens Retraction Timing

The lens is normally retracted for safety about one minute after you press the [▶] button in Shooting mode (122). To have the lens retracted immediately after you press the [▶] button, set the retraction timing to [0 sec.].

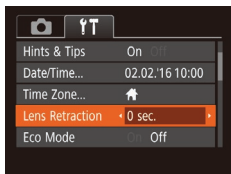

- Choose [Lens Retraction], and then choose [0 sec.].

Using Eco Mode

This function allows you to conserve battery power in Shooting mode. When the camera is not in use, the screen quickly darkens to reduce battery consumption.

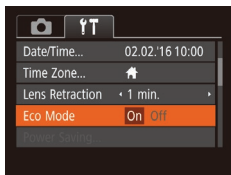

1 Configure the setting.

- Choose [Eco Mode], and then choose [On].
- [ECO] is now shown on the shooting screen (132).
- The screen darkens when the camera is not used for approximately two seconds; approximately ten seconds after darkening, the screen turns off. The camera turns off after approximately three minutes of inactivity.

2 Shoot.

- To activate the screen and prepare for shooting when the screen is off but the lens is still out, press the shutter button halfway.

Power-Saving Adjustment

Adjust the timing of automatic camera and screen deactivation (Auto Power Down and Display Off, respectively) as needed (123).

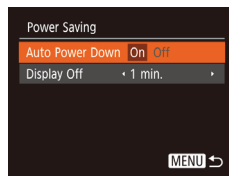

- Choose [Power Saving], and then press the [P] button.
- After choosing an item, press the [◀][▶] buttons to adjust it as needed.



- To conserve battery power, you should normally choose [On] for [Auto Power Down] and [1 min.] or less for [Display Off].



- The [Display Off] setting is applied even if you set [Auto Power Down] to [Off].
- These power-saving functions are not available when you have set Eco mode (108) to [On].

Before Use

Basic Guide

Advanced Guide

1 Camera Basics

2 Auto Mode

3 Other Shooting Modes

4 P Mode

5 Playback Mode

6 Wi-Fi Functions

7 Setting Menu

8 Accessories

9 Appendix

Index

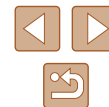

Screen Brightness

Adjust screen brightness as follows.



- Choose [Disp. Brightness], and then press the [◀][▶] buttons to adjust the brightness.



- For maximum brightness, press and hold the [▼] button for at least one second when the shooting screen is displayed or when in single-image display. (This will override the [Disp. Brightness] setting on the [↑↑] tab.) To restore the original brightness, press and hold the [▼] button again for at least one second or restart the camera.

Hiding the Start-Up Screen

If you prefer, you can deactivate display of the start-up screen normally shown when you turn the camera on.



- Choose [Start-up Image], and then choose [Off].

Formatting Memory Cards

Before using a new memory card or a card formatted in another device, you should format the card with this camera.

Formatting erases all data on a memory card. Before formatting, copy images on the memory card to a computer, or take other steps to back them up.

1 Access the [Format] screen.

- Choose [Format], and then press the [Ⓜ] button.

2 Choose [OK].

- Press the [▲][▼] buttons to choose [Cancel], press the [◀][▶] buttons to choose [OK], and then press the [Ⓜ] button.

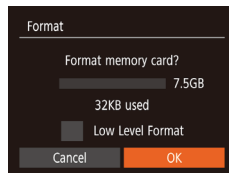

3 Format the memory card.

- To begin the formatting process, press the [▲][▼] buttons to choose [OK], and then press the [Ⓜ] button.
- When formatting is finished, [Memory card formatting complete] is displayed. Press the [Ⓜ] button.

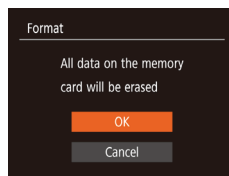

- Formatting or erasing data on a memory card only changes file management information on the card and does not erase the data completely. When transferring or disposing of memory cards, please be cautious. Take steps to protect personal information if necessary, as by physically destroying cards.

Before Use

Basic Guide

Advanced Guide

1 Camera Basics

2 Auto Mode

3 Other Shooting Modes

4 P Mode

5 Playback Mode

6 Wi-Fi Functions

7 Setting Menu

8 Accessories

9 Appendix

Index





- The total card capacity indicated on the formatting screen may be less than the advertised capacity.

Low-Level Formatting

Perform low-level formatting in the following cases: [Memory card error] is displayed, the camera is not working correctly, card image reading/writing is slower, continuous shooting is slower, or movie recording suddenly stops. Low-level formatting erases all data on a memory card. Before low-level formatting, copy images on the memory card to a computer, or take other steps to back them up.

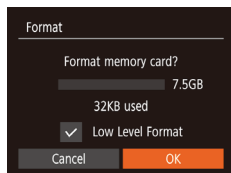

- On the screen in step 2 of “Formatting Memory Cards” (109), press the [▲][▼] buttons to choose [Low Level Format], and then press the [◀][▶] buttons to select this option. A [✓] icon is displayed.
- Follow steps 2 – 3 in “Formatting Memory Cards” (109) to continue with the formatting process.



- Low-level formatting takes longer than “Formatting Memory Cards” (109), because data is erased from all storage regions of the memory card.
- You can cancel low-level formatting in progress by choosing [Stop]. In this case, all data will be erased, but the memory card can be used normally.

File Numbering

Your shots are automatically numbered in sequential order (0001 – 9999) and saved in folders that store up to 2,000 images each. You can change how the camera assigns file numbers.



- Choose [File Numbering], and then choose an option.

Continuous	Images are numbered consecutively (until the 9999th shot is taken/saved) even if you switch memory cards.
Auto Reset	Image numbering is reset to 0001 if you switch memory cards, or when a new folder is created.



- Regardless of the option selected in this setting, shots may be numbered consecutively after the last number of existing images on newly inserted memory cards. To start saving shots from 0001, use an empty (or formatted, 109) memory card.

Before Use

Basic Guide

Advanced Guide

1 Camera Basics

2 Auto Mode

3 Other Shooting Modes

4 P Mode

5 Playback Mode

6 Wi-Fi Functions

7 Setting Menu

8 Accessories

9 Appendix

Index



Date-Based Image Storage

Instead of saving images in folders created each month, you can have the camera create folders each day you shoot to store shots taken that day.



- Choose [Create Folder], and then choose [Daily].
- Images will now be saved in folders created on the shooting date.

Metric / Non-Metric Display

Change the unit of measurement shown in GPS elevation information (102), zoom bar (28), and elsewhere from m/cm to ft/in as needed.



- Choose [Units], and then choose [ft/in].

Checking Certification Logos

Some logos for certification requirements met by the camera can be viewed on the screen. Other certification logos are printed in this guide, on the camera packaging, or on the camera body.

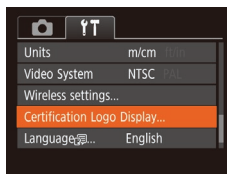

- Choose [Certification Logo Display], and then press the [MENU] button.

Display Language

Change the display language as needed.



- Choose [Language], and then press the [MENU] button.
- Press the [▲][▼][◀][▶] buttons to choose a language, and then press the [MENU] button.



- You can also access the [Language] screen in Playback mode by pressing and holding the [MENU] button and immediately pressing the [MENU] button.

Adjusting Other Settings

The following settings can also be adjusted on the [MENU] tab.

- [Video System] (116)
- [Wireless settings] (78)

Before Use

Basic Guide

Advanced Guide

1 Camera Basics

2 Auto Mode

3 Other Shooting Modes

4 P Mode

5 Playback Mode

6 Wi-Fi Functions

7 Setting Menu

8 Accessories

9 Appendix

Index

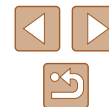

Restoring Defaults

If you accidentally change a setting, you can restore default camera settings.

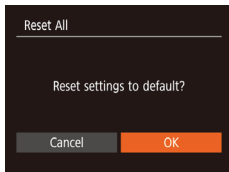

1 Access the [Reset All] screen.

- Choose [Reset All], and then press the [⏏] button.

2 Restore default settings.

- Press the [◀][▶] buttons to choose [OK], and then press the [⏏] button.
- Default settings are now restored.



- The following functions are not restored to default settings.
 - [📅] tab settings [Date/Time] (📖107), [🌐] [Time Zone] (📖107), [🗣️] [Language] (📖111), and [📺] [Video System] (📖116)
 - Custom white balance data you have recorded (📖52)
 - Shooting mode (📖43)

Before Use

Basic Guide

Advanced Guide

1 Camera Basics

2 Auto Mode

3 Other Shooting Modes

4 P Mode

5 Playback Mode

6 Wi-Fi Functions

7 Setting Menu

8 Accessories

9 Appendix

Index



8

Accessories

Enjoy the camera in more ways with optional Canon accessories and other compatible accessories sold separately

System Map

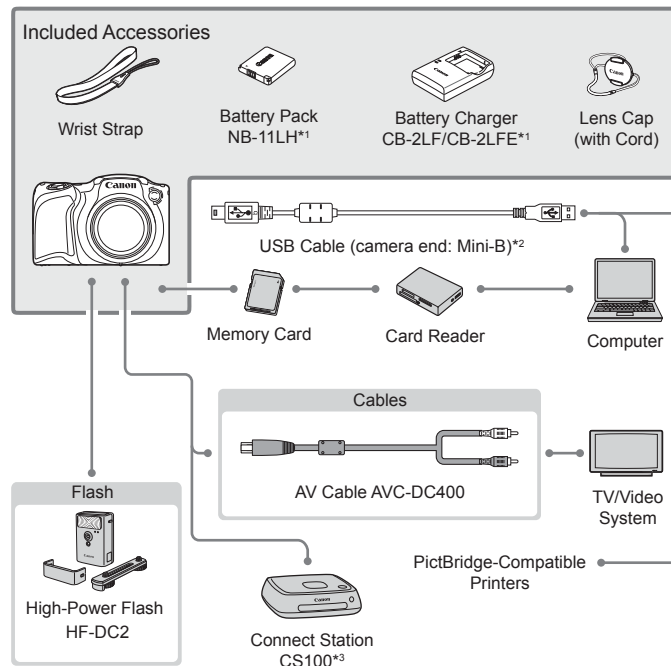

*1 Also available for purchase separately.

*2 A genuine Canon accessory is also available (Interface Cable IFC-400PCU).

*3 Use the latest firmware.

Before Use

Basic Guide

Advanced Guide

1 Camera Basics

2 Auto Mode

3 Other Shooting Modes

4 P Mode

5 Playback Mode

6 Wi-Fi Functions

7 Setting Menu

8 Accessories

9 Appendix

Index

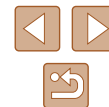

Use of genuine Canon accessories is recommended.

This product is designed to achieve excellent performance when used with genuine Canon accessories. Canon shall not be liable for any damage to this product and/or accidents such as fire, etc., caused by the malfunction of non-genuine Canon accessories (e.g., a leakage and/or explosion of a battery pack). Please note that this warranty does not apply to repairs arising out of the malfunction of non-genuine Canon accessories, although you may request such repairs on a chargeable basis.

Optional Accessories

The following camera accessories are sold separately. Note that some accessories may no longer be available. Also, availability varies by area.

Power Supplies

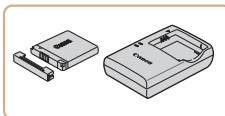

Battery Pack NB-11LH

- Rechargeable lithium-ion battery.

Battery Charger CB-2LF/CB-2LFE

- Charger for battery pack NB-11LH.



- The battery pack includes a convenient cover which you can attach to know the charge status at a glance. Attach the cover so that ▲ is visible on a charged battery pack, and attach it so that ▲ is not visible on an uncharged battery pack.
- Battery Pack NB-11L is also supported.
- Battery Charger CB-2LD and CB-2LDE are also supported.



- The battery charger can be used in areas with 100 – 240 V AC power (50/60 Hz).
- For power outlets in a different format, use a commercially available adapter for the plug. Never use an electrical transformer designed for traveling, which may damage the battery pack.

Before Use

Basic Guide

Advanced Guide

1 Camera Basics

2 Auto Mode

3 Other Shooting Modes

4 P Mode

5 Playback Mode

6 Wi-Fi Functions

7 Setting Menu

8 Accessories

9 Appendix

Index

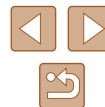

Flash Unit

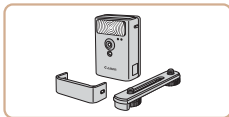

High-Power Flash HF-DC2

- External flash for illuminating subjects that are out of range of the built-in flash.

Other Accessories

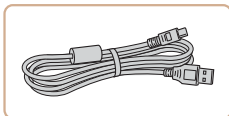

Interface Cable IFC-400PCU

- For connecting the camera to a computer or printer.

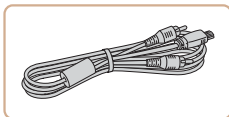

AV Cable AVC-DC400

- Connect the camera to a TV to enjoy playback on the larger TV screen.

Printer

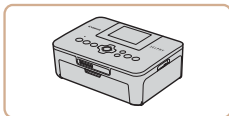

Canon-Brand PictBridge-Compatible Printers

- Even without using a computer, you can print images by connecting the camera directly to a printer. For details, visit your nearest Canon retailer.

Photo Storage

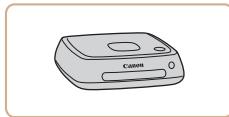

Connect Station CS100

- In addition to saving images you shot with your camera and viewing them on a TV, this device allows you to print from Wi-Fi printers and share your images on the Internet.

Before Use

Basic Guide

Advanced Guide

1 Camera Basics

2 Auto Mode

3 Other Shooting Modes

4 P Mode

5 Playback Mode

6 Wi-Fi Functions

7 Setting Menu

8 Accessories

9 Appendix

Index

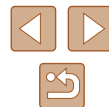

Using Optional Accessories

Playback on a TV

▶ Still Images ▶ Movies

Connecting the camera to a TV with the AV Cable AVC-DC400 (sold separately) enables you to view your shots on the larger screen of the TV as you control the camera.

For details on connection or how to switch inputs, refer to the TV manual.



- Some information may not be displayed when viewing images on a TV (133).

1 Make sure the camera and TV are off.

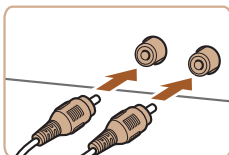

2 Connect the camera to the TV.

- On the TV, insert the cable plugs fully into the video inputs as shown.
- Make sure the cable plugs are in video inputs of the same color.
- On the camera, open the terminal cover and insert the cable plug fully into the camera terminal.

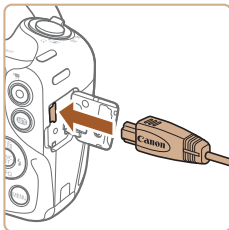

3 Turn the TV on and switch to video input.

- Switch the TV input to the video input you connected the cable to in step 2.

4 Turn the camera on.

- Press the [▶] button to turn the camera on.
- Images from the camera are now displayed on the TV. (Nothing is displayed on the camera screen.)
- When finished, turn off the camera and TV before disconnecting the cable.



- Correct display is not possible unless the camera video output format (NTSC or PAL) matches the TV format. To change the video output format, press the [MENU] button and choose [Video System] on the [↑] tab.

Before Use

Basic Guide

Advanced Guide

1 Camera Basics

2 Auto Mode

3 Other Shooting Modes

4 P Mode

5 Playback Mode

6 Wi-Fi Functions

7 Setting Menu

8 Accessories

9 Appendix

Index



Using the Software

After downloading the software from the Canon website and installing it on your computer, you can do the following things.

- CameraWindow
 - Import images and change camera settings
- Image Transfer Utility
 - Set Image Sync (📖99), receive images
- Map Utility
 - Shows the GPS information recorded in images on a map



- When viewing or editing images on a computer, always use software that supports the images shot on the camera (software normally installed on the computer or general-use software).

Connect to a Computer Using a Cable

Checking Your Computer Environment

For detailed system requirements and compatibility information for computers that can use this software, including support in new operating systems, visit the Canon website.

Installing the Software

For instructions on installing the software, see “Installing the Software” (📖85).

Saving Images to a Computer

When you connect the camera to the computer using a retail USB cable (the camera uses Mini-B), you can save your images to the computer.

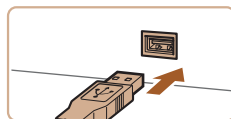
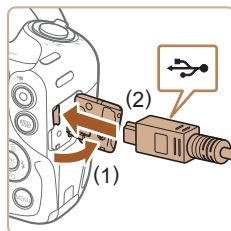

1 Connect the camera to the computer.

- With the camera turned off, open the cover (1). With the smaller plug of the USB cable in the orientation shown, insert the plug fully into the camera terminal (2).

- Insert the larger plug of the USB cable in the computer's USB port. For details about USB connections on the computer, refer to the computer user manual.

2 Turn the camera on to access CameraWindow.

- Press the [▶] button to turn the camera on.
- Mac OS: CameraWindow is displayed when a connection is established between the camera and computer.

Before Use

Basic Guide

Advanced Guide

1 Camera Basics

2 Auto Mode

3 Other Shooting Modes

4 P Mode

5 Playback Mode

6 Wi-Fi Functions

7 Setting Menu

8 Accessories

9 Appendix

Index





- Windows: Follow the steps introduced below.
- In the screen that is displayed, click the change program link of [].
- Choose [Downloads Images From Canon Camera] and then click [OK].

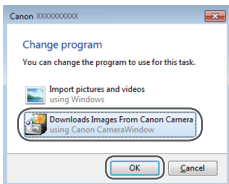



- Double-click [].

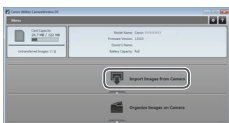

3 Save the images to the computer.

- Click [Import Images from Camera], and then click [Import Untransferred Images].
- Images are now saved to the Pictures folder on the computer, in separate folders named by date.
- After images are saved, close CameraWindow, press the [] button to turn the camera off, and unplug the cable.
- To look at a image saved on your computer, use a software (such as one installed on your computer by default or general software) that supports images shot with a camera.



- Windows 7: If the screen in step 2 is not displayed, click the  icon in the taskbar.
- Mac OS: If CameraWindow is not displayed after step 2, click the [CameraWindow] icon in the Dock.
- Although you can save images to a computer simply by connecting your camera to the computer without using the software, the following limitations apply.
 - It may take a few minutes after you connect the camera to the computer until camera images are accessible.
 - Images shot in vertical orientation may be saved in horizontal orientation.
 - Image protection settings may be cleared from images saved to a computer.
 - Some problems may occur when saving images or image information, depending on the operating system version, the software in use, or image file sizes.

Before Use

Basic Guide

Advanced Guide

1 Camera Basics

2 Auto Mode

3 Other Shooting Modes

4 P Mode

5 Playback Mode

6 Wi-Fi Functions

7 Setting Menu

8 Accessories

9 Appendix

Index



Printing Images

▶ Still Images ▶ Movies

Your shots can easily be printed by connecting the camera to a printer. On the camera, you can specify images to set up batch printing, prepare orders for photo development services, and prepare orders or print images for photobooks.

A Canon SELPHY CP series compact photo printer is used here for the sake of illustration. Screens displayed and available functions vary by printer. Also refer to the printer manual for additional information.

Easy Print

▶ Still Images ▶ Movies

Easily print your shots by connecting the camera to a PictBridge-compatible printer (sold separately) with the USB cable.

1 Make sure the camera and printer are off.

2 Connect the camera to the printer.

- Open the terminal cover. Holding the smaller cable plug in the orientation shown, insert the plug fully into the camera terminal.
- Connect the larger cable plug to the printer. For other connection details, refer to the printer manual.

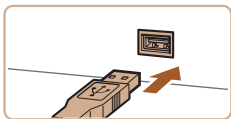
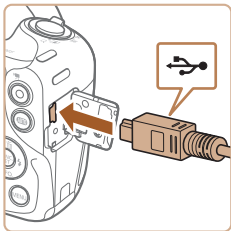

3 Turn the printer on.



4 Turn the camera on.

- Press the [▶] button to turn the camera on.

5 Choose an image.

- Press the [◀][▶] buttons to choose an image.



6 Access the printing screen.

- Press the [Ⓜ] button, choose [▶], and press the [Ⓜ] button again.

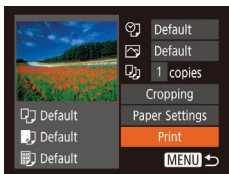

7 Print the image.

- Press the [▲][▼] buttons to choose [Print], and then press the [Ⓜ] button.
- Printing now begins.
- To print other images, repeat the above procedures starting from step 5 after printing is finished.
- When you are finished printing, turn the camera and printer off and disconnect the cable.



- For Canon-brand PictBridge-compatible printers (sold separately), see "Printer" (115).

Before Use

Basic Guide

Advanced Guide

1 Camera Basics

2 Auto Mode

3 Other Shooting Modes

4 P Mode

5 Playback Mode

6 Wi-Fi Functions

7 Setting Menu

8 Accessories

9 Appendix

Index



Configuring Print Settings

▶ Still Images ▶ Movies

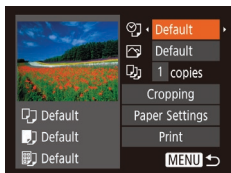

1 Access the printing screen.

- Follow steps 1 – 6 in “Easy Print” (119) to access this screen.

2 Configure the settings.

- Press the [▲][▼] buttons to choose an item, and then press the [◀][▶] buttons to choose an option.

🗨️	Default	Matches current printer settings.
	Date	Prints images with the date added.
	File No.	Prints images with the file number added.
	Both	Prints images with both the date and file number added.
🖨️	Off	–
	Default	Matches current printer settings.
	Off	–
	On	Uses information from the time of shooting to print under optimal settings.
👁️	Red-Eye 1	Corrects red-eye.
	No. of Copies	Choose the number of copies to print.
Cropping	–	Specify a desired image area to print (120).
Paper Settings	–	Specify the paper size, layout, and other details (121).

▶ Cropping Images before Printing

▶ Still Images ▶ Movies

By cropping images before printing, you can print a desired image area instead of the entire image.

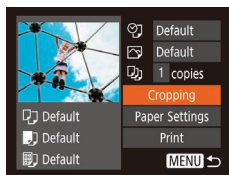

1 Choose [Cropping].

- After following step 1 in “Configuring Print Settings” (120) to access the printing screen, choose [Cropping] and press the [OK] button.
- A cropping frame is now displayed, indicating the image area to print.

2 Adjust the cropping frame as needed.

- To resize the frame, move the zoom lever.
- To move the frame, press the [▲][▼][◀][▶] buttons.
- To rotate the frame, press the [⊞] button.
- Press the [MENU] button, press the [▲][▼] buttons to choose [OK], and then press the [⊞] button.

3 Print the image.

- Follow step 7 in “Easy Print” (119) to print.



- Cropping may not be possible at small image sizes, or at some aspect ratios.
- Dates may not be printed correctly if you crop images shot with [Date Stamp] selected.

Before Use

Basic Guide

Advanced Guide

1 Camera Basics

2 Auto Mode

3 Other Shooting Modes

4 P Mode

5 Playback Mode

6 Wi-Fi Functions

7 Setting Menu

8 Accessories

9 Appendix

Index



Choosing Paper Size and Layout before Printing

► Still Images ► Movies

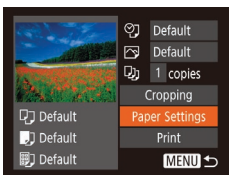

1 Choose [Paper Settings].

- After following step 1 in “Configuring Print Settings” (120) to access the printing screen, choose [Paper Settings] and press the [OK] button.

2 Choose a paper size.

- Press the [▲][▼] buttons to choose an option, and then press the [OK] button.

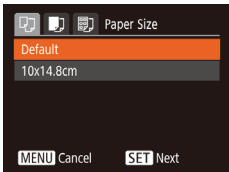

3 Choose a type of paper.

- Press the [▲][▼] buttons to choose an option, and then press the [OK] button.

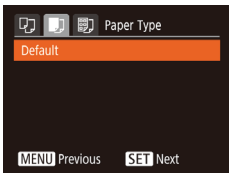

4 Choose a layout.

- Press the [▲][▼] buttons to choose an option.
- When choosing [N-up], press the [◀][▶] buttons to specify the number of images per sheet.
- Press the [OK] button.

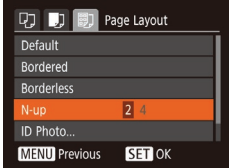

5 Print the image.

Available Layout Options

Default	Matches current printer settings.
Bordered	Prints with blank space around the image.
Borderless	Borderless, edge-to-edge printing.
N-up	Choose how many images to print per sheet.
ID Photo	Prints images for identification purposes. Only available for images with a resolution of L and an aspect ratio of 4:3.
Fixed Size	Choose the print size. Choose from 3.5 x 5 in., postcard, or wide-format prints.

Printing ID Photos

► Still Images ► Movies

1 Choose [ID Photo].

- Following steps 1 – 4 in “Choosing Paper Size and Layout before Printing” (121), choose [ID Photo] and press the [OK] button.

2 Choose the long and short side length.

- Press the [▲][▼] buttons to choose an item. Choose the length by pressing the [◀][▶] buttons, and then press the [OK] button.

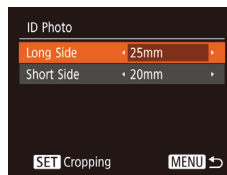

Before Use

Basic Guide

Advanced Guide

1 Camera Basics

2 Auto Mode

3 Other Shooting Modes

4 P Mode

5 Playback Mode

6 Wi-Fi Functions

7 Setting Menu

8 Accessories

9 Appendix

Index



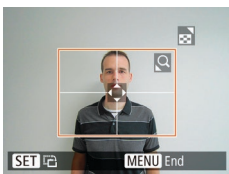

3 Choose the printing area.

- Follow step 2 in “Cropping Images before Printing” (120) to choose the printing area.

4 Print the image.

Printing Movie Scenes

► Still Images ► Movies

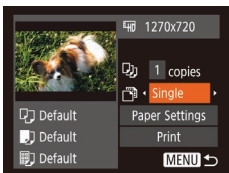

1 Access the printing screen.

- Follow steps 1 – 6 in “Easy Print” (119) to choose a movie. This screen is displayed.

2 Choose a printing method.

- Press the [▲][▼] buttons to choose [Single], and then press the [◀][▶] buttons to choose the printing method.

3 Print the image.

Movie Printing Options

Single	Prints the current scene as a still image.
Sequence	Prints a series of scenes, a certain interval apart, on a single sheet of paper. You can also print the folder number, file number, and elapsed time for the frame by setting [Caption] to [On].



- To cancel printing, press the [STOP] button, choose [OK], and then press the [STOP] button again.
- The screen in step 1 can also be displayed by the following procedure: Display the movie scene that you want to print by following steps 2 – 5 in “Viewing” (161), press the [◀][▶] buttons to choose [Print] from the movie control panel, then press the [STOP] button.

Before Use

Basic Guide

Advanced Guide

1 Camera Basics

2 Auto Mode

3 Other Shooting Modes

4 P Mode

5 Playback Mode

6 Wi-Fi Functions

7 Setting Menu

8 Accessories

9 Appendix

Index



Adding Images to the Print List (DPOF)

► Still Images ► Movies

Batch printing (124) and ordering prints from a photo development service can be set up on the camera. Choose up to 998 images on a memory card and configure relevant settings, such as the number of copies, as follows. The printing information you prepare this way will conform to DPOF (Digital Print Order Format) standards.

Configuring Print Settings

► Still Images ► Movies

Specify the printing format, whether to add the date or file number, and other settings as follows. These settings apply to all images in the print list.

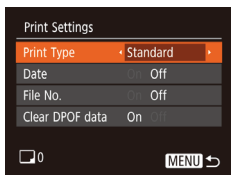

- Press the [MENU] button, and then choose [Print Settings] on the [D] tab. Choose and configure items as desired (25).

Print Type	Standard	One image is printed per sheet.
	Index	Smaller versions of multiple images are printed per sheet.
	Both	Both standard and index formats are printed.
Date	On	Images are printed with the shooting date.
	Off	–
File No.	On	Images are printed with the file number.
	Off	–
Clear DPOF data	On	All image print list settings are cleared after printing.
	Off	–



- Not all of your DPOF settings may be applied in printing by the printer or photo development service, in some cases.
- [!] may be displayed on the camera to warn you that the memory card has print settings that were configured on another camera. Changing the print settings using this camera may overwrite all previous settings.



- Specifying [Index] will prevent you from choosing [On] for both [Date] and [File No.] at the same time.
- Index printing is not available on some Canon-brand PictBridge-compatible printers (sold separately).
- The date is printed in a format matching setting details in [Date/Time] on the [↑] tab (17).

Setting Up Printing for Individual Images

► Still Images ► Movies

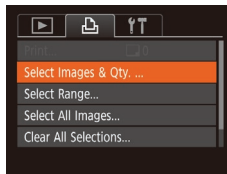

1 Choose [Select Images & Qty].

- Press the [MENU] button, choose [Select Images & Qty.] on the [D] tab, and then press the [OK] button.

2 Choose an image.

- Press the [◀][▶] buttons to choose an image, and then press the [OK] button.
- You can now specify the number of copies.
- If you specify index printing for the image, it is labeled with a [✓] icon. To cancel index printing for the image, press the [OK] button again. [✓] is no longer displayed.

Before Use

Basic Guide

Advanced Guide

1 Camera Basics

2 Auto Mode

3 Other Shooting Modes

4 P Mode

5 Playback Mode

6 Wi-Fi Functions

7 Setting Menu

8 Accessories

9 Appendix

Index





3 Specify the number of prints.

- Press the [**▲**][**▼**] buttons to specify the number of prints (up to 99).
- To set up printing for other images and specify the number of prints, repeat steps 2 – 3.
- Printing quantity cannot be specified for index prints. You can only choose which images to print, by following step 2.
- When finished, press the [**MENU**] button to return to the menu screen.

Setting Up Printing for a Range of Images

► Still Images ► Movies

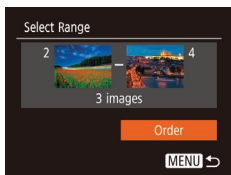

- Following step 1 in “Setting Up Printing for Individual Images” (123), choose [Select Range] and press the [**OK**] button.
- Follow steps 2 – 3 in “Selecting a Range” (68) to specify images.
- Press the [**▲**][**▼**] buttons to choose [Order], and then press the [**OK**] button.

Setting Up Printing for All Images

► Still Images ► Movies

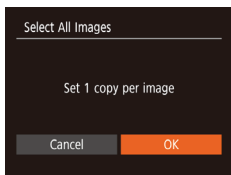

- Following step 1 in “Setting Up Printing for Individual Images” (123), choose [Select All Images] and press the [**OK**] button.
- Press the [**◀**][**▶**] buttons to choose [OK], and then press the [**OK**] button.

Clearing All Images from the Print List

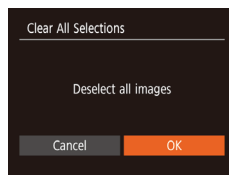

- Following step 1 in “Setting Up Printing for Individual Images” (123), choose [Clear All Selections] and press the [**OK**] button.
- Press the [**◀**][**▶**] buttons to choose [OK], and then press the [**OK**] button.

Printing Images Added to the Print List (DPOF)

► Still Images ► Movies

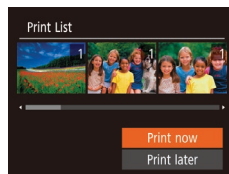

- When images have been added to the print list (123 – 124), this screen is displayed after you connect the camera to a PictBridge-compatible printer. Press the [**▲**][**▼**] buttons to choose [Print now], and then simply press the [**OK**] button to print the images in the print list.
- Any DPOF print job that you temporarily stop will be resumed from the next image.

Before Use
Basic Guide
Advanced Guide
1 Camera Basics
2 Auto Mode
3 Other Shooting Modes
4 P Mode
5 Playback Mode
6 Wi-Fi Functions
7 Setting Menu
8 Accessories
9 Appendix
Index



Adding Images to a Photobook

► Still Images ► Movies

Photobooks can be set up on the camera by choosing up to 998 images on a memory card and importing them into the software CameraWindow (📖117) on your computer, where they are stored in their own folder. This is convenient when ordering printed photobooks online or printing photobooks with your own printer.

Choosing a Selection Method

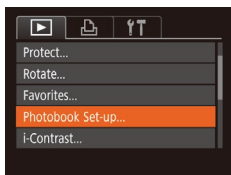

- Press the [MENU] button, choose [Photobook Set-up] on the [▶] tab, and then choose how you will select images.



- [!] may be displayed on the camera to warn you that the memory card has print settings that were configured on another camera. Changing the print settings using this camera may overwrite all previous settings.

Adding Images Individually

► Still Images ► Movies

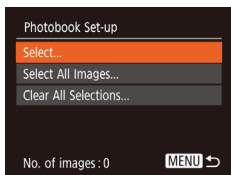

1 Choose [Select].

- Following the procedure in “Choosing a Selection Method” (📖125), choose [Select] and press the [⊕] button.



2 Choose an image.

- Press the [◀][▶] buttons to choose an image, and then press the [⊕] button.
- [✓] is displayed.
- To remove the image from the photobook, press the [⊖] button again. [✓] is no longer displayed.
- Repeat this process to specify other images.
- When finished, press the [MENU] button to return to the menu screen.

Adding All Images to a Photobook

► Still Images ► Movies

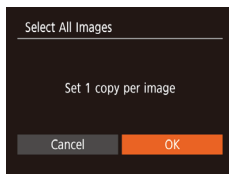

- Following the procedure in “Choosing a Selection Method” (📖125), choose [Select All Images] and press the [⊕] button.
- Press the [◀][▶] buttons to choose [OK], and then press the [⊕] button.

Removing All Images from a Photobook

► Still Images ► Movies

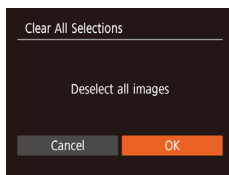

- Following the procedure in “Choosing a Selection Method” (📖125), choose [Clear All Selections] and press the [⊖] button.
- Press the [◀][▶] buttons to choose [OK], and then press the [⊖] button.

Before Use

Basic Guide

Advanced Guide

1 Camera Basics

2 Auto Mode

3 Other Shooting Modes

4 P Mode

5 Playback Mode

6 Wi-Fi Functions

7 Setting Menu

8 Accessories

9 Appendix

Index



Appendix

Helpful information when using the camera

9

Troubleshooting

If you think there is a problem with the camera, first check the following. If the items below do not solve your problem, contact a Canon Customer Support Help Desk.

Power

Nothing happens when the ON/OFF button is pressed.

- Confirm that the battery pack is charged (📖15).
- Confirm that the battery pack is inserted facing the correct way (📖16).
- Confirm that the memory card/battery cover is fully closed (📖16).
- Dirty battery terminals reduce battery performance. Try cleaning the terminals with a cotton swab and reinserting the battery pack a few times.

The battery pack runs out of power quickly.

- Battery performance decreases at low temperatures. Try warming the battery pack a little by putting it in your pocket, for example, ensuring that the terminals do not touch any metal objects.
- Dirty battery terminals reduce battery performance. Try cleaning the terminals with a cotton swab and reinserting the battery pack a few times.
- If these measures do not help and the battery pack still runs out of power soon after charging, it has reached the end of its life. Purchase a new battery pack.

The lens is not retracted.

- Do not open the memory card/battery cover while the camera is on. Close the cover, turn the camera on, and then turn it off again (📖16).

The battery pack is swollen.

- Battery swelling is normal and does not pose any safety concerns. However, if battery swelling prevents the battery pack from fitting in the camera, contact a Canon Customer Support Help Desk.

Display on a TV

Camera images look distorted or not displayed on a TV (📖116).

Before Use

Basic Guide

Advanced Guide

1 Camera Basics

2 Auto Mode

3 Other Shooting Modes

4 P Mode

5 Playback Mode

6 Wi-Fi Functions

7 Setting Menu

8 Accessories

9 Appendix

Index

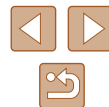

Shooting

Cannot shoot.

- In Playback mode (📖61), press the shutter button halfway (📖23).

Strange display on the screen under low light (📖24).

Strange display on the screen when shooting.

- The following display problems are not recorded in still images but are recorded in movies. Please take note of this.
 - The screen may darken under bright light.
 - The screen may flicker under fluorescent or LED lighting.
 - Purplish banding may appear on the screen if you compose a shot that includes a bright light source.

No date stamp is added to images.

- Configure the [Date Stamp] (📖35). Note that date stamps are not added to images automatically, merely because you have configured the [Date/Time] setting (📖17).
- Date stamps are not added in shooting modes (📖137) in which [Date Stamp] cannot be configured (📖35).

⚡ flashes on the screen when the shutter button is pressed, and shooting is not possible (📖30).

📖 is displayed when the shutter button is pressed halfway (📖30).

- Set [IS Mode] to [Continuous] (📖59).
- Raise the flash and set the flash mode to ⚡ (📖58).
- Increase the ISO speed (📖51).
- Mount the camera on a tripod or take other measures to keep it still. Additionally, you should set [IS Mode] to [Off] when using a tripod or other means to secure the camera (📖59).

Shots are out of focus.

- Press the shutter button halfway to focus on subjects before pressing it all the way down to shoot (📖23).
- Make sure subjects are within focus range (📖142).
- Set [AF-assist Beam] to [On] (📖39).
- Confirm that unneeded functions such as macro are deactivated.
- Try shooting with Focus Lock (📖55).

No AF frames are displayed and the camera does not focus when the shutter button is pressed halfway.

- To have AF frames displayed and the camera focus correctly, try composing the shot with higher-contrast subject areas centered before you press the shutter button halfway. Otherwise, try pressing the shutter button halfway repeatedly.

Subjects in shots look too dark.

- Raise the flash and set the flash mode to ⚡ (📖58).
- Adjust brightness by using exposure compensation (📖50).
- Adjust contrast by using i-Contrast (📖51, 📖75).
- Use spot metering (📖50).

Subjects look too bright, highlights are washed-out.

- Lower the flash and set the flash mode to ☀️ (📖28).
- Adjust brightness by using exposure compensation (📖50).
- Use spot metering (📖50).
- Reduce the lighting on subjects.

Shots look too dark despite the flash firing (📖30).

- Shoot within flash range (📖141).
- Increase the ISO speed (📖51).

Subjects in flash shots look too bright, highlights are washed-out.

- Shoot within flash range (📖141).
- Lower the flash and set the flash mode to ☀️ (📖28).

White spots appear in flash shots.

- This is caused by light from the flash reflecting off dust or airborne particles.

Shots look grainy.

- Lower the ISO speed (📖51).

Subjects are affected by red-eye.

- Set [Red-Eye Lamp] to [On] (📖40). Note that while the red-eye reduction lamp (📖4) is lit (for about one second), it is not possible to shoot, because the lamp is counteracting red-eye. For best results, have subjects look at the red-eye reduction lamp. Also try increasing the lighting in indoor scenes and shooting at closer range.
- Edit images using red-eye correction (📖76).

Before Use

Basic Guide

Advanced Guide

1 Camera Basics

2 Auto Mode

3 Other Shooting Modes

4 P Mode

5 Playback Mode

6 Wi-Fi Functions

7 Setting Menu

8 Accessories

9 Appendix

Index



Recording to the memory card takes too long, or continuous shooting is slower.

- Use the camera to perform low-level formatting of the memory card (📖110).

Shooting settings or FUNC. menu settings are not available.

- Available setting items vary by shooting mode. Refer to “Functions Available in Each Shooting Mode”, “FUNC. Menu”, and “Shooting Tab” (📖134 – 📖137).

Shooting Movies

The elapsed time shown is incorrect, or recording is interrupted.

- Use the camera to format the memory card, or switch to a card that supports high-speed recording. Note that even if the elapsed time display is incorrect, the length of movies on the memory card corresponds to the actual recording time (📖109, 📖143).

[!] is displayed and shooting stops automatically.

- The camera’s internal memory buffer filled up as the camera could not record to the memory card quickly enough. Try one of the following measures.
 - Use the camera to perform low-level formatting of the memory card (📖110).
 - Lower the image quality (📖38).
 - Switch to a memory card that supports high-speed recording (📖143).

Zooming is not possible.

- Zooming is not possible when shooting movies in [📹] mode (📖45).

Playback

Playback is not possible.

- Image or movie playback may not be possible if a computer is used to rename files or alter the folder structure.

Playback stops, or audio skips.

- Switch to a memory card that you have performed low-level formatting on with the camera (📖110).
- There may be brief interruptions when playing movies copied to memory cards that have slow read speeds.
- When movies are played on a computer, frames may be dropped and audio may skip if computer performance is inadequate.

Sound is not played during movies.

- Adjust the volume (📖106) if you have activated [Mute] (📖106) or the sound in the movie is faint.
- No sound is played for movies shot in [📹] mode (📖45) because audio is not recorded in this mode.

Memory Card

The memory card is not recognized.

- Restart the camera, with the memory card in it (📖22).

Computer

Cannot transfer images to a computer.

- When attempting to transfer images to the computer via a cable, try reducing the transfer speed as follows.
 - Press the [📷] button to enter Playback mode. Hold the [MENU] button down as you press the [▲] and [🔍] buttons at the same time. On the next screen, press the [◀][▶] buttons to choose [B], and then press the [🔍] button.

Before Use

Basic Guide

Advanced Guide

1 Camera Basics

2 Auto Mode

3 Other Shooting Modes

4 P Mode

5 Playback Mode

6 Wi-Fi Functions

7 Setting Menu

8 Accessories

9 Appendix

Index

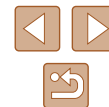

Wi-Fi

Cannot access the Wi-Fi menu by pressing the  button.

- The Wi-Fi menu cannot be accessed while the camera is connected to a printer or computer via a cable. Disconnect the cable.

Cannot add a device/destination.

- A total of 20 items of connection information can be added to the camera. Erase unneeded connection information from the camera first, and then add new devices/destinations (103).
- Use a computer or smartphone to register Web services (90).
- To add a smartphone, first install the dedicated application Camera Connect on your smartphone (79).
- To add a computer, first install the software CameraWindow on your computer. Also check your computer and Wi-Fi environment and settings (85, 86).
- Do not use the camera near sources of Wi-Fi signal interference, such as microwave ovens, Bluetooth devices, or other equipment operating on the 2.4 GHz band.
- Bring the camera closer to the other device you are trying to connect to (such as the access point), and make sure there are no objects between the devices.

Cannot connect to the access point.

- Confirm that the access point channel is set to a channel supported by the camera (141). Note that instead of auto channel assignment, it is advisable to specify a supported channel manually.

Cannot send images.

- The destination device has insufficient storage space. Increase the storage space on the destination device and resend the images.
- The write-protect switch of the memory card in the destination camera is set to the locked position. Slide the write-protect switch to the unlocked position.
- Images are not sent to CANON iMAGE GATEWAY or other Web services if you move or rename image files or folders on the computer that received images sent using Image Sync via an access point (99). Before moving or renaming these image files or folders on the computer, make sure the images have already been sent to CANON iMAGE GATEWAY or other Web services.

Cannot resize images for sending.

- Images cannot be resized to larger than their original resolution.
- Movies cannot be resized.

Images take a long time to send./The wireless connection is disrupted.

- Multiple images may take a long time to send. Try resizing the images to reduce sending time (98).
- Movies may take a long time to send.
- Do not use the camera near sources of Wi-Fi signal interference, such as microwave ovens, Bluetooth devices, or other equipment operating on the 2.4 GHz band. Note that images may take a long time to send even when  is displayed.
- Bring the camera closer to the other device you are trying to connect to (such as the access point), and make sure there are no objects between the devices.

No notification message is received on a computer or smartphone after adding CANON iMAGE GATEWAY to the camera.

- Make sure the e-mail address you entered is correct, and try adding the destination again.
- Check the e-mail settings on the computer or smartphone. If they are configured to block e-mail from certain domains, you may not be able to receive the notification message.

Want to erase Wi-Fi connection information before disposing of the camera or giving it to someone else.

- Reset the Wi-Fi settings (105).

Before Use

Basic Guide

Advanced Guide

1 Camera Basics

2 Auto Mode

3 Other Shooting Modes

4 P Mode

5 Playback Mode

6 Wi-Fi Functions

7 Setting Menu

8 Accessories

9 Appendix

Index

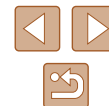

On-Screen Messages

If an error message is displayed, respond as follows.

Shooting or Playback

No memory card

- The memory card may be inserted facing the wrong way. Reinsert the memory card facing the correct way (116).

Memory card locked

- The write-protect switch of the memory card is set to the locked position. Switch the write-protect switch to the unlocked position (116).

Cannot record!

- Shooting was attempted without a memory card in the camera. To shoot, insert a memory card facing the correct way (116).

Memory card error (110)

- If the same error message is displayed even after you have formatted a supported memory card (112) and have inserted it facing the correct way (116), contact a Canon Customer Support Help Desk.

Insufficient space on card

- There is not enough free space on the memory card to shoot (128, 142, 149) or edit images (173). Either erase unneeded images (170) or insert a memory card with enough free space (116).

Charge the battery (115)

No Image.

- The memory card does not contain any images that can be displayed.

Protected! (167)

Unidentified Image/Incompatible JPEG/Image too large/Cannot play back MP4

- Unsupported or corrupt images cannot be displayed.
- It may not be possible to display images that were edited or renamed on a computer, or images shot with another camera.

Cannot magnify!/Cannot play back this content in Smart Shuffle/Cannot rotate/Cannot modify image/Cannot modify/Cannot assign to category/Unselectable image

- The following functions may be unavailable for images that were renamed or already edited on a computer, or images shot with another camera. Note that starred (*) functions are not available for movies. Magnify* (165), Smart Shuffle* (166), Rotate* (171), Favorites (172), Edit* (173), Print List* (123), and Photobook Set-up* (125)

Invalid selection range

- When specifying a range for image selection (168, 171, 124), you attempted to choose an initial image that was after the final image, or vice-versa.

Exceeded selection limit

- More than 998 images were selected for Print List (123) or Photobook Set-up (125). Choose 998 images or less.
- Print List (123) or Photobook Set-up (125) settings could not be saved correctly. Reduce the number of selected images and try again.
- You attempted to choose more than 500 images in Protect (167), Erase (170), Favorites (172), Print List (123), or Photobook Set-up (125).

Naming error!

- The folder could not be created or images could not be recorded, because the highest supported folder number (999) for storing images on the card has been reached and the highest supported image number (9999) for images in folders has been reached. On the **[Fn]** tab, change [File Numbering] to [Auto Reset] (110), or format the memory card (109).

Lens Error

- This error may occur if the lens is held while it is moving, or when the camera is used in dusty or sandy locations.
- Frequent display of this error message may indicate camera damage. In this case, contact a Canon Customer Support Help Desk.

A camera error was detected (error number)

- If this error message is displayed immediately after a shot, the image may not have been saved. Switch to Playback mode to check for the image.
- Frequent display of this error message may indicate camera damage. In this case, write down the error number (Exx) and contact a Canon Customer Support Help Desk.

Before Use

Basic Guide

Advanced Guide

1 Camera Basics

2 Auto Mode

3 Other Shooting Modes

4 P Mode

5 Playback Mode

6 Wi-Fi Functions

7 Setting Menu

8 Accessories

9 Appendix

Index



File Error

- Correct printing (📖119) may not be possible for photos from other cameras or images that have been altered using computer software, even if the camera is connected to the printer.

Print error

- Check the paper size setting (📖121). If this error message is displayed when the setting is correct, restart the printer and complete the setting on the camera again.

Ink absorber full

- Contact a Canon Customer Support Help Desk to request assistance with ink absorber replacement.

Wi-Fi

Connection failed

- No access points were recognized. Check the access point settings (📖86).
- A device could not be found. Turn the camera off and on again, and retry the connection.
- Check the device you want to connect to and make sure it is ready for connection.

Cannot determine access point

- The WPS buttons on numerous access points were pressed simultaneously. Try reconnecting again.

No access points found

- Check to make sure that the access point is turned on.
- When connecting to an access point manually, make sure that you entered the correct SSID.

Incorrect password/Incorrect Wi-Fi security settings

- Check the access point security settings (📖86).

IP address conflict

- Reset the IP address so that it does not conflict with another.

Disconnected/Receiving failed/Sending failed

- You may be in an environment where Wi-Fi signals are obstructed.
- Do not use the camera near microwave ovens, Bluetooth devices, and other devices that operate on the 2.4 GHz band.
- Bring the camera closer to the other device you are trying to connect to (such as the access point), and make sure there are no objects between the devices.
- Check the connected device to make sure it is not experiencing errors.

Sending failed

Memory card error

- If the same error message is displayed even when you have inserted a formatted memory card facing the correct way, contact a Canon Customer Support Help Desk.

Receiving failed

Insufficient space on card

- There is not enough free space on the memory card in the target camera to receive images. Erase images to create space on the memory card, or insert a memory card with sufficient space.

Receiving failed

Memory card locked

- The write-protect switch of the memory card in the camera to receive the images is set to the locked position. Slide the write-protect switch to the unlocked position.

Receiving failed

Naming error!

- When the highest folder number (999), and the highest image number (999) have been reached on the receiving camera, images cannot be received.

Insufficient space on server

- Delete unnecessary images uploaded to CANON iIMAGE GATEWAY to create space.
- Save the images sent via Image Sync (📖99) to your computer.

Check network settings

- Check to make sure your computer can connect to the Internet with the current network settings.

Before Use

Basic Guide

Advanced Guide

1 Camera Basics

2 Auto Mode

3 Other Shooting Modes

4 P Mode

5 Playback Mode

6 Wi-Fi Functions

7 Setting Menu

8 Accessories

9 Appendix

Index



On-Screen Information

Shooting (Information Display)

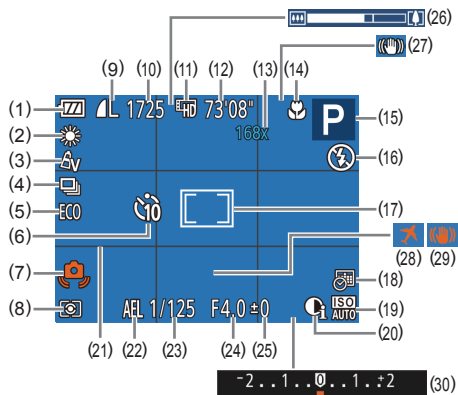

- (1) Battery level (📖132)
- (2) White balance (📖52)
- (3) My Colors (📖52)
- (4) Drive mode (📖36)
- (5) Eco mode (📖108)
- (6) Self-timer (📖34)
- (7) Camera shake warning (📖30)
- (8) Metering method (📖50)
- (9) Still image compression (📖59), Resolution (📖37)
- (10) Recordable shots (📖143)
- (11) Movie quality (📖38)
- (12) Remaining time (📖143)
- (13) Zoom magnification (📖33), Digital tele-converter (📖54)
- (14) Focus range (📖54, 📖54)
- (15) Shooting mode (📖134), Scene icon (📖31)
- (16) Flash mode (📖58)
- (17) AF frame (📖55), Spot AE point frame (📖50)
- (18) Date stamp (📖35)
- (19) ISO speed (📖51)
- (20) i-Contrast (📖51)
- (21) Grid lines (📖38)

- (22) AE lock (📖50)
- (23) Shutter speed
- (24) Aperture value
- (25) Exposure compensation level (📖50)
- (26) Zoom bar (📖28)
- (27) IS mode icon (📖32)
- (28) Time zone (📖107)
- (29) Image stabilization (📖59)
- (30) Exposure compensation bar (📖50)

Battery Level

An on-screen icon or message indicates the battery charge level.

Display	Details
	Sufficient charge.
	Slightly depleted, but sufficient.
	Nearly depleted. Charge the battery pack soon.
[Charge the battery]	Depleted. Charge the battery pack immediately.

Before Use

Basic Guide

Advanced Guide

1 Camera Basics

2 Auto Mode

3 Other Shooting Modes

4 P Mode

5 Playback Mode

6 Wi-Fi Functions

7 Setting Menu

8 Accessories

9 Appendix

Index



Playback (Detailed Information Display)

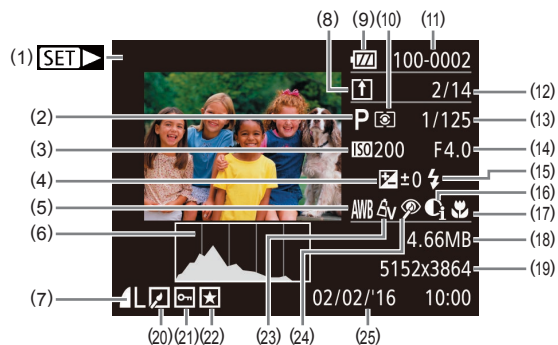

- | | |
|--|--|
| (1) Movie recording (📖28, 📖61) | (13) Shutter speed (still images), Image quality / Frame rate (movies) (📖38) |
| (2) Shooting mode (📖134) | (14) Aperture value |
| (3) ISO speed (📖51), Playback speed (📖45) | (15) Flash (📖58) |
| (4) Exposure compensation level (📖50) | (16) i-Contrast (📖51, 📖75) |
| (5) White balance (📖52) | (17) Focus range (📖54, 📖54) |
| (6) Histogram (📖63) | (18) File size |
| (7) Compression (image quality) (📖59) / Resolution (📖37), MP4 (movies) | (19) Still images: Resolution (📖143) Movies: Playback time (📖143) |
| (8) Image Sync (📖99) | (20) Image editing (📖73) |
| (9) Battery level (📖132) | (21) Protection (📖67) |
| (10) Metering method (📖50) | (22) Favorites (📖72) |
| (11) Folder number - File number (📖110) | (23) My Colors (📖52, 📖75) |
| (12) Current image no. / Total no. of images | (24) Red-eye correction (📖76) |
| | (25) Shooting date/time (📖17) |



- Some information may not be displayed when viewing images on a TV (📖116).

Summary of Movie Control Panel

The following operations are available on the movie control panel, accessed as described in “Viewing” (📖61).

	Exit
	Play
	Slow Motion (Press the [◀][▶] buttons to adjust the playback speed. No sound is played.)
	Skip Backward* (To continue skipping backward, keep holding down the [⏮] button.)
	Previous Frame (For fast-rewind, keep holding down the [⏪] button.)
	Next Frame (For fast-forward, keep holding down the [⏩] button.)
	Skip Forward* (To continue skipping forward, keep holding down the [⏭] button.)
	Edit (📖77)
	Shown when the camera is connected to a PictBridge-compatible printer (📖119).

* Displays the frame approx. 4 sec. before or after the current frame.



- To skip forward or back during movie playback, press the [◀][▶] buttons.

Before Use

Basic Guide

Advanced Guide

1 Camera Basics

2 Auto Mode

3 Other Shooting Modes

4 P Mode

5 Playback Mode

6 Wi-Fi Functions

7 Setting Menu

8 Accessories

9 Appendix

Index



Functions and Menu Tables

Functions Available in Each Shooting Mode

Function	Shooting Mode													
	AUTO	P	LIVE											
Exposure Compensation (📖50)	-	○	○	○	○	○	○	○	○	○	○	-	○	-
Flash (📖58)														
	○	○	○	○	○	○	○	○	○	○	○	○	-	-
	-	○	○	○	○	-	○	○	○	○	○	○	-	○
	*1	○	○	-	-	-	-	-	-	-	-	-	-	-
	○	○	○	○	○	○	○	○	○	○	○	○	○	○
Focus Range (📖54, 📖54)														
	○	○	○	○	○	○	○	○	○	○	○	○	○	○
	-	○	○	○	-	○	○	○	○	○	○	○	-	○
Tracking AF (📖56)	-	○	○	○	-	○	-	-	-	○	○	○	-	○
Change Display (📖24)	○	○	-	○	-	○	-	-	-	-	○	○	○	○

*1 Not available. However, it may switch to in some cases.

Before Use

Basic Guide

Advanced Guide

1 Camera Basics

2 Auto Mode

3 Other Shooting Modes

4 P Mode

5 Playback Mode

6 Wi-Fi Functions

7 Setting Menu

8 Accessories

9 Appendix

Index



FUNC. Menu

	Shooting Mode														
Function	AUTO	P	LIVE												
Metering Method (50)															
	<input type="radio"/>	<input type="radio"/>	<input type="radio"/>	<input type="radio"/>	<input type="radio"/>	<input type="radio"/>	<input type="radio"/>	<input type="radio"/>	<input type="radio"/>	<input type="radio"/>	<input type="radio"/>	<input type="radio"/>	<input type="radio"/>	<input type="radio"/>	<input type="radio"/>
	-	<input type="radio"/>	-	-	-	-	-	-	-	-	-	-	-	-	-
My Colors (52)															
	<input type="radio"/>	<input type="radio"/>	<input type="radio"/>	<input type="radio"/>	<input type="radio"/>	<input type="radio"/>	<input type="radio"/>	<input type="radio"/>	<input type="radio"/>	<input type="radio"/>	<input type="radio"/>	<input type="radio"/>	<input type="radio"/>	<input type="radio"/>	<input type="radio"/>
Av AN AW*1 AW*1 Ap AL AD AB AG AR AC*2	-	<input type="radio"/>	-	-	<input type="radio"/>	-	-	-	-	-	-	-	-	-	<input type="radio"/>
White Balance (52)															
AWB	<input type="radio"/>	<input type="radio"/>	<input type="radio"/>	<input type="radio"/>	<input type="radio"/>	<input type="radio"/>	<input type="radio"/>	<input type="radio"/>	<input type="radio"/>	<input type="radio"/>	<input type="radio"/>	<input type="radio"/>	<input type="radio"/>	<input type="radio"/>	<input type="radio"/>
	-	<input type="radio"/>	-	-	<input type="radio"/>	<input type="radio"/>	-	-	-	-	-	-	-	-	<input type="radio"/>
ISO Speed (51)															
ISO AUTO	<input type="radio"/>	<input type="radio"/>	<input type="radio"/>	<input type="radio"/>	<input type="radio"/>	<input type="radio"/>	<input type="radio"/>	<input type="radio"/>	<input type="radio"/>	<input type="radio"/>	<input type="radio"/>	<input type="radio"/>	<input type="radio"/>	<input type="radio"/>	-
ISO 100 200 400 800 1600	-	<input type="radio"/>	-	-	-	-	-	-	-	-	-	-	-	-	<input type="radio"/>
Self-Timer (34)															
	<input type="radio"/>	<input type="radio"/>	<input type="radio"/>	<input type="radio"/>	<input type="radio"/>	<input type="radio"/>	<input type="radio"/>	<input type="radio"/>	<input type="radio"/>	<input type="radio"/>	<input type="radio"/>	<input type="radio"/>	<input type="radio"/>	<input type="radio"/>	<input type="radio"/>
	<input type="radio"/>	<input type="radio"/>	<input type="radio"/>	<input type="radio"/>	-	<input type="radio"/>	<input type="radio"/>	<input type="radio"/>	<input type="radio"/>	<input type="radio"/>	<input type="radio"/>	<input type="radio"/>	<input type="radio"/>	<input type="radio"/>	<input type="radio"/>
Self-Timer Settings (35)															
	<input type="radio"/>	<input type="radio"/>	<input type="radio"/>	<input type="radio"/>	-	<input type="radio"/>	<input type="radio"/>	<input type="radio"/>	<input type="radio"/>	<input type="radio"/>	<input type="radio"/>	<input type="radio"/>	<input type="radio"/>	<input type="radio"/>	<input type="radio"/>
Drive Mode (36)															
	<input type="radio"/>	<input type="radio"/>	<input type="radio"/>	<input type="radio"/>	<input type="radio"/>	<input type="radio"/>	<input type="radio"/>	<input type="radio"/>	<input type="radio"/>	<input type="radio"/>	<input type="radio"/>	<input type="radio"/>	<input type="radio"/>	<input type="radio"/>	<input type="radio"/>
	<input type="radio"/>	<input type="radio"/>	-	<input type="radio"/>	-	<input type="radio"/>	<input type="radio"/>	<input type="radio"/>	<input type="radio"/>	<input type="radio"/>	<input type="radio"/>	<input type="radio"/>	<input type="radio"/>	<input type="radio"/>	-

*1 White balance is not available.

*2 Set in a range of 1 – 5: contrast, sharpness, color saturation, red, green, blue, and skin tone.

Before Use

Basic Guide

Advanced Guide

1 Camera Basics

2 Auto Mode

3 Other Shooting Modes

4 P Mode

5 Playback Mode

6 Wi-Fi Functions

7 Setting Menu

8 Accessories

9 Appendix

Index

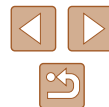

		Shooting Mode														
Function		AUTO	P	LIVE												
Still Image Aspect Ratio (📖37)																
16:9		○	○	–	○	○	–	–	○	–	○	○	○	○	○	
3:2 1:1		○	○	–	○	○	–	–	–	–	○	○	○	○	○	
4:3		○	○	○	○	○	○	○	○	○	○	○	○	○	○	
Resolution (📖37)																
L		○	○	○	○	○	–	○	○	○	○	○	○	○	○	
M1M2S		○	○	–	○	○	–	–	–	–	–	–	○	○	○	
M		–	–	–	–	–	○	–	–	–	–	–	–	–	–	
Compression (📖59)																
		–	○	–	–	–	–	–	–	–	–	–	–	–	–	
		○	○	○	○	○	○	○	○	○	○	○	○	○	○	
Movie Quality (📖38)																
		○	○	○	○	○	○	○	○	*1	○	○	○	○	○	

*1 Linked to aspect ratio settings and automatically set (📖45)

Before Use
Basic Guide
Advanced Guide
1 Camera Basics
2 Auto Mode
3 Other Shooting Modes
4 P Mode
5 Playback Mode
6 Wi-Fi Functions
7 Setting Menu
8 Accessories
9 Appendix
Index



Shooting Tab

Function	Shooting Mode													
	AUTO	P	LIVE											
AF Frame (📖55)														
Face AiAF	○	○	○	○	○	○	-	-	○	○	○	○	-	○
Tracking AF	-	○	○	○	-	○	-	-	-	○	○	○	-	○
Center	-	○	○	○	-	○	○	-	○	○	○	○	○	○
AF Frame Size (📖55)*1														
Normal	-	○	○	○	-	○	○	-	○	○	○	○	-	○
Small	-	○	○	○	-	○	-	-	○	○	○	○	-	○
Digital Zoom (📖33)														
Standard	○	○	○	○	○	-	-	-	-	-	-	-	○	○
Off*2	○	○	○	○	○	○	○	○	○	○	○	○	○	○
Tele-Converter 1.6x/Tele-Converter 2.0x	-	○	○	-	-	-	-	-	-	-	-	-	-	-
AF-Point Zoom (📖39)														
On	○	○	○	○	○	○	-	-	-	○	○	○	-	○
Off	○	○	○	○	○	○	○	○	○	○	○	○	○	○
Servo AF (📖57)														
On	-	○	○	○	-	○	-	-	-	○	○	○	-	-
Off	*3	○	○	○	○	○	○	○	○	○	○	○	○	○
Continuous AF (📖57)														
On	○	○	○	○	○	-	○	○	○	○	○	○	-	○
Off	-	○	○	○	-	○	○	○	○	○	○	○	○	○

*1 Available when the AF frame is set to [Center].

*2 When transitioning to a shooting mode where zoom is unavailable, unlocks zoom

*3 [On] when subject movement is detected.

Before Use

Basic Guide

Advanced Guide

1 Camera Basics

2 Auto Mode

3 Other Shooting Modes

4 P Mode

5 Playback Mode

6 Wi-Fi Functions

7 Setting Menu

8 Accessories

9 Appendix

Index



Function		Shooting Mode													
		AUTO	P	LIVE											
AF-assist Beam (39)															
On		<input type="radio"/>	<input type="radio"/>	<input type="radio"/>	<input type="radio"/>	<input type="radio"/>	<input type="radio"/>	<input type="radio"/>	<input type="radio"/>	<input type="radio"/>	<input type="radio"/>	<input type="radio"/>	<input type="radio"/>	-	<input type="radio"/>
Off		<input type="radio"/>	<input type="radio"/>	<input type="radio"/>	<input type="radio"/>	<input type="radio"/>	<input type="radio"/>	<input type="radio"/>	<input type="radio"/>	<input type="radio"/>	<input type="radio"/>	<input type="radio"/>	<input type="radio"/>	<input type="radio"/>	<input type="radio"/>
Flash Settings (40)															
Red-Eye Lamp	On/Off	<input type="radio"/>	<input type="radio"/>	<input type="radio"/>	<input type="radio"/>	<input type="radio"/>	<input type="radio"/>	<input type="radio"/>	<input type="radio"/>	<input type="radio"/>	<input type="radio"/>	<input type="radio"/>	<input type="radio"/>	-	<input type="radio"/>
i-Contrast (51)															
Auto		<input type="radio"/>	<input type="radio"/>	-	-	-	<input type="radio"/>	-	-	-	-	-	-	-	-
Off		-	<input type="radio"/>	<input type="radio"/>	<input type="radio"/>	<input type="radio"/>	-	<input type="radio"/>	<input type="radio"/>	<input type="radio"/>	<input type="radio"/>	<input type="radio"/>	<input type="radio"/>	<input type="radio"/>	<input type="radio"/>
Review Image after Shooting (40)															
Display Time	Off/Quick/2 sec./4 sec./8 sec./Hold	<input type="radio"/>	<input type="radio"/>	<input type="radio"/>	<input type="radio"/>	<input type="radio"/>	<input type="radio"/>	<input type="radio"/>	<input type="radio"/>	<input type="radio"/>	<input type="radio"/>	<input type="radio"/>	<input type="radio"/>	<input type="radio"/>	<input type="radio"/>
Display Info	Off/Detailed	<input type="radio"/>	<input type="radio"/>	<input type="radio"/>	<input type="radio"/>	<input type="radio"/>	<input type="radio"/>	<input type="radio"/>	<input type="radio"/>	<input type="radio"/>	<input type="radio"/>	<input type="radio"/>	<input type="radio"/>	<input type="radio"/>	<input type="radio"/>
Grid Lines (38)															
On/Off		<input type="radio"/>	<input type="radio"/>	<input type="radio"/>	<input type="radio"/>	<input type="radio"/>	<input type="radio"/>	<input type="radio"/>	<input type="radio"/>	<input type="radio"/>	<input type="radio"/>	<input type="radio"/>	<input type="radio"/>	<input type="radio"/>	<input type="radio"/>
IS Settings (59)															
IS Mode	Continuous/Off	<input type="radio"/>	<input type="radio"/>	<input type="radio"/>	<input type="radio"/>	<input type="radio"/>	<input type="radio"/>	<input type="radio"/>	<input type="radio"/>	<input type="radio"/>	<input type="radio"/>	<input type="radio"/>	<input type="radio"/>	<input type="radio"/>	<input type="radio"/>
	Shoot Only	-	<input type="radio"/>	<input type="radio"/>	<input type="radio"/>	<input type="radio"/>	<input type="radio"/>	<input type="radio"/>	<input type="radio"/>	<input type="radio"/>	<input type="radio"/>	<input type="radio"/>	<input type="radio"/>	<input type="radio"/>	<input type="radio"/>
Dynamic IS	1	<input type="radio"/>	<input type="radio"/>	<input type="radio"/>	<input type="radio"/>	<input type="radio"/>	<input type="radio"/>	<input type="radio"/>	-	<input type="radio"/>	<input type="radio"/>	<input type="radio"/>	<input type="radio"/>	<input type="radio"/>	<input type="radio"/>
	2	<input type="radio"/>	<input type="radio"/>	<input type="radio"/>	<input type="radio"/>	<input type="radio"/>	<input type="radio"/>	<input type="radio"/>	<input type="radio"/>	<input type="radio"/>	<input type="radio"/>	<input type="radio"/>	<input type="radio"/>	<input type="radio"/>	<input type="radio"/>
Date Stamp (35)															
Off		<input type="radio"/>	<input type="radio"/>	<input type="radio"/>	<input type="radio"/>	<input type="radio"/>	<input type="radio"/>	<input type="radio"/>	<input type="radio"/>	<input type="radio"/>	<input type="radio"/>	<input type="radio"/>	<input type="radio"/>	<input type="radio"/>	<input type="radio"/>
Date/Date & Time		<input type="radio"/>	<input type="radio"/>	<input type="radio"/>	<input type="radio"/>	<input type="radio"/>	<input type="radio"/>	-	-	-	-	-	-	<input type="radio"/>	<input type="radio"/>

Before Use
Basic Guide
Advanced Guide
1 Camera Basics
2 Auto Mode
3 Other Shooting Modes
4 P Mode
5 Playback Mode
6 Wi-Fi Functions
7 Setting Menu
8 Accessories
9 Appendix
Index



Set Up Tab

Options	Reference Page
Mute	106
Volume	106
Hints & Tips	107
Date/Time	17
Time Zone	107
Lens Retraction	108
Eco Mode	108
Power Saving	23, 108
Disp. Brightness	109
Start-up Image	109
Format	109, 110
File Numbering	110
Create Folder	111
Units	111
Video System	116
Wireless settings	78
Certification Logo Display	111
Language	18
Reset All	112

Playback Tab

Options	Reference Page
Slideshow	66
Erase	70
Protect	67
Rotate	71
Favorites	72
Photobook Set-up	125
i-Contrast	75
Red-Eye Correction	76
Cropping	74
Resize	73
My Colors	75
Transition	61
Scroll Display	61
Auto Rotate	72
Resume	61

Before Use

Basic Guide

Advanced Guide

1 Camera Basics

2 Auto Mode

3 Other Shooting Modes

4 P Mode

5 Playback Mode

6 Wi-Fi Functions

7 Setting Menu

8 Accessories

9 Appendix

Index

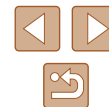

Print Tab

Options	Reference Page
Print	–
Select Images & Qty.	123
Select Range	124
Select All Images	124
Clear All Selections	124
Print Settings	123

Playback Mode FUNC. Menu

Options	Reference Page
Rotate	71
Protect	67
Favorites	72
Printing	119
Play Movie	61
Smart Shuffle	66
Image Search	64
Slideshow	66

Handling Precautions

- The camera is a high-precision electronic device. Avoid dropping it or subjecting it to strong impact.
- Never bring the camera near magnets, motors, or other devices that generate strong electromagnetic fields. The electromagnetic fields may cause malfunction in the camera or erase image data.
- If water droplets or dirt adheres to the camera or screen, wipe with a dry soft cloth, such as an eyeglass cloth. Do not rub hard or apply force.
- Never use cleaners containing organic solvents to clean the camera or screen.
- Use a blower brush to remove dust from the lens. If cleaning is difficult, contact a Canon Customer Support Help Desk.
- When you suddenly transfer the camera from cold place to hot environments, condensation (water drops) may form on the camera. To prevent condensation from forming on the camera after sudden temperature changes, put the camera in an airtight, resealable plastic bag and let it gradually adjust to the temperature before removing it from the bag.
- If condensation does form on the camera, stop using it immediately. Continuing to use the camera in this state may damage it. Remove the battery pack and memory card, and wait until the moisture has evaporated before resuming use.
- Store unused battery packs in a plastic bag or other container. To maintain battery performance if you will not use the battery pack for some time, charge it about once a year and then use the camera until it runs out of power before storing the battery pack.

Before Use

Basic Guide

Advanced Guide

1 Camera Basics

2 Auto Mode

3 Other Shooting Modes

4 P Mode

5 Playback Mode

6 Wi-Fi Functions

7 Setting Menu

8 Accessories

9 Appendix

Index

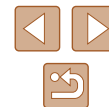

Specifications

Camera

Image Sensor

Camera Effective Pixels (Max.)

(Image processing may cause a decrease

in the number of pixels.) Approx. 20.0 megapixels

Total Pixels..... Approx. 20.5 megapixels

Image Size..... 1/2.3 type

Lens

Focal Length

(35mm film equivalent) 4.3 – 180.6 mm
(24 – 1008 mm)

Zoom Magnification 42x

Digital zoom

Magnification..... Approx. 4x

Max. Magnification

(digital x optical zoom)..... Approx. 168x

Focal Length

(max. telephoto, 35mm film equivalent) Equivalent to approx. 4032 mm

Screen (Monitor)

Type..... TFT color liquid crystal

Screen Size 7.5 cm (3.0 in.)

Effective Pixels Approx. 230,000 dots

Continuous Shooting

Speed

(Varies depending on the subject, zoom

position, and other shooting factors,

as well as memory card brands.) Normal Continuous Shooting in
Auto/P modes: Approx. 0.5 shots/
sec.

Normal Continuous Shooting Low
Light mode: Approx. 2.2 shots/sec.

Built-In Flash

Flash Range (Wide angle end)..... 50 cm – 5.0 m (1.6 – 16 ft.)

Flash Range (Telephoto end)..... 1.4 m – 2.7 m (4.6 – 8.9 ft.)

Shutter Speed

Auto Mode (automatic settings)..... 1 – 1/4000 sec.

Range in all shooting modes

Maximum 15 sec.

Minimum 1/4000 sec.

Speed (unit: sec.)..... Long Shutter Mode

15, 13, 10, 8, 6, 5, 4, 3.2, 2.5, 2,

1.6, 1.3, 1

Aperture

F number 3.5 – 8.0 (W)

6.6 – 8.0 (T)

AF

AF frame Face AiAF (number of AF frames:
max.9), Tracking AF, Center

File Format..... Design rule for Camera File
system (DCF) compliant; DPOF
(version 1.1) compatible

Data Type (Still Images)

Image File Format..... Exif 2.3 (DCF 2.0)

Image Type JPEG

Data Type (Movies)

Recording Format..... MP4

Video..... MPEG-4 AVC/H.264

Audio..... MPEG-4 AAC-LC (Monaural)

Power Supply

Battery Pack NB-11LH

Before Use

Basic Guide

Advanced Guide

1 Camera Basics

2 Auto Mode

3 Other Shooting Modes

4 P Mode

5 Playback Mode

6 Wi-Fi Functions

7 Setting Menu

8 Accessories

9 Appendix

Index



Interface	
Wired	Hi-Speed USB (Mini-B) Analog Audio Output (Monaural) Analog Video Output (NTSC/PAL)
Wireless	Wi-Fi Specifications: IEEE 802.11b/g/n Frequency: 2.4 GHz Channels: 1 – 11 Security: WEP, WPA-PSK (AES/ TKIP), WPA2-PSK (AES/TKIP) NFC
Operating Environment	
Temperature.....	0 – 40 °C (32 – 104 °F)
Dimensions (CIPA compliant)	
(WxHxD)	104.4 x 69.1 x 85.1 mm (4.11 x 2.72 x 3.35 in.)
Weight (CIPA compliant)	
Including Battery Pack, Memory Card	Approx. 325 g (approx. 11.5 oz.)
Camera Body Only	Approx. 308 g (approx. 10.9 oz.)

Number of Shots/Recording Time, Playback Time

Number of Still Image Shots (CIPA compliant)	Approx. 195 shots
Number of Still Image Shots (Eco Mode On)	Approx. 260 shots
Movie Recording Time (CIPA compliant)*1	Approx. 50 min.
Movie Recording Time (Continuous Shooting)*2	Approx. 1 hr. 30 min.
Playback Time*3	Approx. 5 hr.

*1 Total time when shooting repeatedly with the following conditions





- [AUTO] mode and defaults for other settings
- Shooting/pausing, zooming, turning the camera on and off

*2 Total time when shooting repeatedly with the following conditions

- [AUTO] mode and defaults for other settings
- If the maximum amount of movie recording time or number of shots is reached, the camera will shut down / restart.

*3 Time when playing a still image slideshow.

Shooting Range

Shooting Mode	Focus Range	Maximum Wide Angle ()	Maximum Telephoto ()
AUTO	–	0 cm (0 in.) – infinity	1.4 m (4.6 ft.) – infinity
Other modes		5 cm (2.0 in.) – infinity	1.4 m (4.6 ft.) – infinity
		0 – 50 cm (0 in. – 1.6 ft.)	–
		3.0 m (9.8 ft.) – infinity	3.0 m (9.8 ft.) – infinity

Before Use

Basic Guide

Advanced Guide

1 Camera Basics

2 Auto Mode

3 Other Shooting Modes

4 P Mode

5 Playback Mode

6 Wi-Fi Functions

7 Setting Menu

8 Accessories

9 Appendix









Index



Number of Shots per Memory Card

The number of shots at an aspect ratio (📖37) of 4:3 per memory card is as follows. Note that the number of shots available varies by aspect ratio.

Number of Shots per 16 GB Memory Card (Approx. shots)

L		1792
		3017
M1		3546
		5925
M2		9344
		16755
S		53992
		80988

- The values in the table are based on Canon measurement conditions and may change depending on the subject, memory card and camera settings.

Recording Time per Memory Card

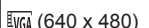
Recording Pixels	Total Recording Time per 16 GB Memory Card (Approx.)	Recording Time for One Time (Approx.)
 (1280 x 720)	2 hr 35 min. 37 sec.	29 min. 59 sec.
 (640 x 480)	8 hr 25 min. 48 sec.	1 hr

- The values in the table are based on Canon measurement conditions and may change depending on the subject, memory card and camera settings.
- Recording times for individual movies are based on memory cards rated at an SD speed class of 10. Recording may stop when cards rated at lower speed classes are used. Recording will also stop automatically when the file size reaches 4 GB, or when the card becomes full.

Before Use

Basic Guide

Advanced Guide

1 Camera Basics

2 Auto Mode

3 Other Shooting Modes

4 P Mode

5 Playback Mode

6 Wi-Fi Functions

7 Setting Menu

8 Accessories

9 Appendix

Index



Battery Pack NB-11LH

Type: Rechargeable lithium-ion battery
Nominal Voltage: 3.6 V DC
Nominal Capacity: 800 mAh
Charging Cycles: Approx. 300 times
Operating Temperatures: 0 – 40 °C (32 – 104 °F)

Battery Charger CB-2LF/CB-2LFE

Rated Input: 100 – 240 V AC (50/60 Hz)
Rated Output: 4.2 V DC, 0.41 A
Charging Time: Approx. 2 hr. 20 min. (when using NB-11LH)
Operating Temperatures: 5 – 40 °C (41 – 104 °F)

- The number of shots that can be taken is based on measurement guidelines of the Camera & Imaging Products Association (CIPA).
- Under some shooting conditions, the number of shots and recording time may be less than mentioned above.
- Number of shots/time with a fully charged battery pack.

Before Use

Basic Guide

Advanced Guide

1 Camera Basics

2 Auto Mode

3 Other Shooting Modes

4 P Mode

5 Playback Mode

6 Wi-Fi Functions

7 Setting Menu

8 Accessories

9 Appendix

Index

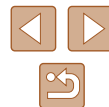

Index

A

Accessories 114
AE lock 50
AF frames 55
Aspect ratio 37
Auto mode (shooting mode) 19, 28
AV cable 115, 116

B

Batteries → Date/time (date/time battery)
 Power saving 23
Battery charger 2, 114
Battery pack
 Charging 15
 Eco mode 108
 Level 132
 Power saving 23
Black and white images 53

C

Camera
 Reset all 112
Camera access point mode 84
Camera connect 79
CameraWindow 117
CANON IMAGE GATEWAY 78, 90
Center (AF frame mode) 55
Clock 27
Color (white balance) 52
Compression ratio (image quality) 59
Connecting via an access point 86
Cropping 74, 120
Custom white balance 52

D

Date/time
 Adding date stamps 35
 Changing 17
 Date/time battery 18
 Settings 17
 World clock 107
Defaults → Reset all
Digital tele-converter 54
Digital zoom 33
Display language 18
DPOF 123

E

Eco mode 108
Editing
 Cropping 74
 i-Contrast 75
 My colors 75
 Red-eye correction 76
 Resizing images 73

Editing or erasing connection information 103
Erase → Erasing
Erasing 70
Erasing all 70
Error messages 130
Exposure
 Compensation 50

F

Face AiAF (AF frame mode) 56
Face self-timer (shooting mode) 47
Favorites 72

File numbering 110
Fireworks → Fireworks (shooting mode)
Fireworks (shooting mode) 43
Fish-eye effect (shooting mode) 44
Flash
 Deactivating flash 58
 On 58
 Slow synchro 58
Focusing
 AF frames 55
 AF-point zoom 39
 Servo AF 57
Focus lock 55
Focus range
 Infinity 54
 Macro 54
FUNC. menu
 Basic operations 24
 Table 135, 140

G

Grid lines 38

I

i-Contrast 51, 75
Image quality → Compression ratio (image quality)
Images
 Display period 40
 Erasing 70
 Playback → Viewing
 Protecting 67
Image stabilization 59
Image sync 99
Indicator 27
Infinity (focus range) 54
ISO speed 51

L

Lamp 39, 40
Live view control (shooting mode) 42
Long shutter (shooting mode) 47
Low light (shooting mode) 43

M

Macro (focus range) 54
Magnified display 65
Memory card 2
 Recording time 143
Menu
 Basic operations 25
 Table 134
Metering method 50
Miniature effect (shooting mode) 45
Monochrome (shooting mode) 46
Movies
 Editing 77
 Image quality (resolution/frame rate) 38
 Recording time 143
My colors 52, 75

P

P (shooting mode) 49
Package contents 2
Photobook set-up 125
PictBridge 115, 119
Playback → Viewing
Portrait (shooting mode) 43
Poster effect (shooting mode) 44
Power 114 → Battery charger
 → Battery pack
Power saving 23
Printing 119
Program AE 49

Before Use
Basic Guide
Advanced Guide
1 Camera Basics
2 Auto Mode
3 Other Shooting Modes
4 P Mode
5 Playback Mode
6 Wi-Fi Functions
7 Setting Menu
8 Accessories
9 Appendix
Index



Protecting 67

R

Red-eye correction 76

Remote shooting 102

Reset all 112

Resizing images 73

Resolution (image size) 37

Rotating 71

S

Saving images to a computer 85, 117

Screen

Display language 18

Icons 132, 133

Menu → FUNC. menu, Menu

SD/SDHC/SDXC memory cards

→ Memory card

Searching 64

Self-timer 34

2-second self-timer 34

Customizing the self-timer 35

Face self-timer (shooting mode)
47

Sending images 97

Sending images to a computer 85

Sending images to another camera
95

Sending images to a printer 94

Sending images to a smartphone 79

Sending images to web services 93

Sepia tone images 53

Servo AF 57

Shooting

Shooting date/time → Date/time

Shooting information 132

Slideshow 66

Smart shuffle 66

Software

Installation 117

Saving images to a computer
85, 117

Sounds 106

Strap 2, 14

Super vivid (shooting mode) 44

T

Terminal 116, 119

Toy camera effect (shooting mode)
46

Tracking AF 56

Traveling with the camera 107

Troubleshooting 126

TV display 116

V

Viewing 20

Image search 64

Index display 64

Magnified display 65

Single-image display 20

Slideshow 66

Smart shuffle 66

TV display 116

W

White balance (color) 52

Wi-Fi functions 78

Wi-Fi menu 82

World clock 107

Wrist strap → Strap

Z

Zoom 19, 29, 33

Before Use

Basic Guide

Advanced Guide

1 Camera Basics

2 Auto Mode

3 Other Shooting Modes

4 P Mode

5 Playback Mode

6 Wi-Fi Functions

7 Setting Menu

8 Accessories

9 Appendix

Index



Wi-Fi (Wireless LAN) Precautions

- Countries and Regions Permitting WLAN Use
 - Use of WLAN is restricted in some countries and regions, and illegal use may be punishable under national or local regulations. To avoid violating WLAN regulations, visit the Canon website to check where use is allowed.
Note that Canon cannot be held liable for any problems arising from use in other countries and regions.
- Doing any of the following may incur legal penalties:
 - Altering or modifying the product
 - Removing the certification labels from the product
- According to foreign exchange and foreign trade law regulations, export permission (or service transaction permission) from the Japanese government is necessary to export strategic resources or services (including this product) outside Japan.
- Because this product includes American encryption software, it falls under U.S. Export Administration Regulations, and cannot be exported to or brought into a country under U.S. trade embargo.
- Be sure to make notes of the wireless LAN settings you use. The wireless LAN settings saved to this product may change or be erased due to incorrect operation of the product, the effects of radio waves or static electricity, or accident or malfunction. Be sure to make notes of wireless LAN settings as a precaution. Please note that Canon accepts no responsibility for direct or indirect damages or loss of earnings resulting from a degradation or disappearance of content.
- When transferring this product to another person, disposing of it, or sending it for repair, be sure to note the wireless LAN settings and reset the product to its default settings (erase settings) if necessary.
- Canon will not make compensation for damages resulting from loss or theft of the product.
Canon accepts no responsibility for damages or loss resulting from unauthorized access or use of target devices registered on this product due to loss or theft of the product.

- Be sure to use the product as directed in this guide. Be sure to use the wireless LAN function of this product within the guidelines noted in this guide. Canon accepts no responsibility for damages or loss if the function is used in ways other than as described in this guide.
- Do not use the wireless LAN function of this product near medical equipment or other electronic equipment. Use of the wireless LAN function near medical equipment or other electronic equipment may affect operation of those devices.

Radio Wave Interference Precautions

- This product may receive interference from other devices that emit radio waves. To avoid interference, be sure to use this product as far away as possible from such devices, or avoid using the devices at the same time as this product.

Security Precautions

Because Wi-Fi uses radio waves to transmit signals, security precautions more stringent than when using a LAN cable are required. Keep the following points in mind when using Wi-Fi.

- Only use networks you are authorized to use
This product searches for Wi-Fi networks in the vicinity and displays the results on the screen. Networks you are not authorized to use (unknown networks) may also be displayed. However, attempting to connect to or using such networks could be regarded as unauthorized access. Be sure to use only networks you are authorized to use, and do not attempt to connect to other unknown networks.

Before Use

Basic Guide

Advanced Guide

1 Camera Basics

2 Auto Mode

3 Other Shooting Modes

4 P Mode

5 Playback Mode

6 Wi-Fi Functions

7 Setting Menu

8 Accessories

9 Appendix

Index

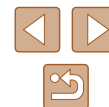

If security settings have not been properly set, the following problems may occur.

- **Transmission monitoring**
Third parties with malicious intent may monitor Wi-Fi transmissions and attempt to acquire the data you are sending.
- **Unauthorized network access**
Third parties with malicious intent may gain unauthorized access to the network you are using to steal, modify, or destroy information. Additionally, you could fall victim to other types of unauthorized access such as impersonation (where someone assumes an identity to gain access to unauthorized information) or springboard attacks (where someone gains unauthorized access to your network as a springboard to cover their tracks when infiltrating other systems).

To prevent these types of problems from occurring, be sure to thoroughly secure your Wi-Fi network.

Only use this camera's Wi-Fi function with a proper understanding of Wi-Fi security, and balance risk and convenience when adjusting security settings.



The camera can print to PictBridge-compatible printers via Wi-Fi. PictBridge technical standards make it easy to connect digital cameras, printers, and other devices directly. Additionally, a new standard called DPS over IP enables PictBridge connections in network environments, and the camera is also compatible with this standard.

Trademarks and Licensing

- Microsoft and Windows are trademarks or registered trademarks of Microsoft Corporation in the United States and/or other countries.
- Macintosh and Mac OS are trademarks of Apple Inc., registered in the U.S. and other countries.
- App Store, iPhone, and iPad are trademarks of Apple Inc.
- The SDXC logo is a trademark of SD-3C, LLC.
- Wi-Fi®, Wi-Fi Alliance®, WPA™, WPA2™ and Wi-Fi Protected Setup™ are trademarks or registered trademarks of the Wi-Fi Alliance.
- The N-Mark is a trademark or registered trademark of NFC Forum, Inc. in the United States and in other countries.
- All other trademarks are the property of their respective owners.
- This device incorporates exFAT technology licensed from Microsoft.
- This product is licensed under AT&T patents for the MPEG-4 standard and may be used for encoding MPEG-4 compliant video and/or decoding MPEG-4 compliant video that was encoded only (1) for a personal and non-commercial purpose or (2) by a video provider licensed under the AT&T patents to provide MPEG-4 compliant video. No license is granted or implied for any other use for MPEG-4 standard.

Before Use
Basic Guide
Advanced Guide
1 Camera Basics
2 Auto Mode
3 Other Shooting Modes
4 P Mode
5 Playback Mode
6 Wi-Fi Functions
7 Setting Menu
8 Accessories
9 Appendix
Index



Disclaimer

- Unauthorized reproduction of this guide is prohibited.
- All measurements based on Canon testing standards.
- Information subject to change without notice, as are product specifications and appearance.
- Illustrations and screenshots in this guide may differ slightly from the actual equipment.
- The above items notwithstanding, Canon cannot be held liable for any loss arising from the use of this product.

Before Use

Basic Guide

Advanced Guide

1 Camera Basics

2 Auto Mode

3 Other Shooting Modes

4 P Mode

5 Playback Mode

6 Wi-Fi Functions

7 Setting Menu

8 Accessories

9 Appendix

Index

