

Blu-ray Disc™ / DVD Player

Operating Instructions

The software of this player may be updated in the future. To download any available updates and the Operating Instructions with advanced features, please visit the following website:

www.sony.eu/support

2 WARNING

Getting Started

- 6 Remote
- 8 Step 1: Connecting the Player
- 9 Step 2: Preparing for Network Connection
- 9 Step 3: Easy Setup

Playback

- 11 Playing a Disc
- 11 Playing from a USB Device
- 12 Playing via a Network
- 12 Listening to Audio from a Bluetooth Device

Additional Information

- 14 Software Update
- 14 Playable discs
- 15 Playable types of files
- 17 Specifications



WARNING

To reduce the risk of fire or electric shock, do not expose this appliance to dripping or splashing, and do not place objects filled with liquids, such as vases, on the appliance.

To avoid electrical shock, do not open the cabinet. Refer servicing to qualified personnel only.

The mains lead must be changed only at a qualified service shop.

Do not expose batteries or appliances with battery-installed to excessive heat, such as sunshine and fire.

CAUTION

The use of optical instruments with this product will increase eye hazard. As the laser beam used in this Blu-ray Disc/DVD player is harmful to eyes, do not attempt to disassemble the cabinet.

Refer servicing to qualified personnel only.

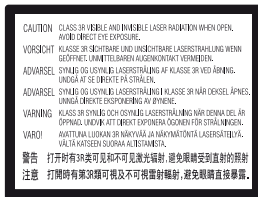



This label is located on the laser protective housing inside the enclosure.



This appliance is classified as a CLASS 1 LASER product. The CLASS 1 LASER PRODUCT MARKING is located on the rear exterior.

Notice for customers in the United Kingdom and Republic of Ireland

A molded plug complying with BS1363 is fitted to this equipment for your safety and convenience.

Should the fuse in the plug supplied need to be replaced, a fuse of the same rating as the supplied one and approved by ASTA or BSI to BS1362, (i.e., marked with  or  mark) must be used. If the plug supplied with this equipment has a detachable fuse cover, be sure to attach the fuse cover after you change the fuse. Never use the plug without the fuse cover. If you should lose the fuse cover, please contact your nearest Sony service station.



Disposal of Old Electrical & Electronic Equipment (Applicable in the European Union and other European countries with separate collection systems)

This symbol on the product or on its packaging indicates that this product shall not be treated as household waste. Instead it shall be handed over to the applicable collection point for the recycling of electrical and electronic equipment. By ensuring this product is disposed of correctly, you will help prevent potential negative consequences for the environment and human health, which could otherwise be caused by inappropriate waste handling of this product. The recycling of materials will help to conserve natural resources. For more detailed information about recycling of this product, please contact your local Civic Office, your household waste disposal service or the shop where you purchased the product.



Disposal of waste batteries (applicable in the European Union and other European countries with separate collection systems)

This symbol on the battery or on the packaging indicates that the battery provided with this product shall not be treated as household waste. On certain batteries this symbol might be used in combination with a chemical symbol. The chemical symbols for mercury (Hg) or lead (Pb) are added if the battery contains more than 0.0005% mercury or 0.004% lead. By ensuring these batteries are disposed of correctly, you will help prevent potentially negative consequences for the environment and human health which could otherwise be caused by inappropriate waste handling of the battery. The recycling of the materials will help to conserve natural resources.

In case of products that for safety, performance or data integrity reasons require a permanent connection with an incorporated battery, this battery should be replaced by qualified service staff only.

To ensure that the battery will be treated properly, hand over the product at end-of-life to the applicable collection point for the recycling of electrical and electronic equipment.

For all other batteries, please view the section on how to remove the battery from the product safely. Hand the battery over to the applicable collection point for the recycling of waste batteries.

For more detailed information about recycling of this product or battery, please contact your local Civic Office, your household waste disposal service or the shop where you purchased the product.

This product has been manufactured by or on behalf of Sony Corporation, 1-7-1 Konan Minato-ku Tokyo, 108-0075 Japan. Inquiries related to product compliance based on European Union legislation shall be addressed to the authorized representative, Sony Deutschland GmbH, Hedelfinger Strasse 61, 70327 Stuttgart, Germany. For any service or guarantee matters, please refer to the addresses provided in the separate service or guarantee documents.

Precautions

- The nameplate is located on the bottom of the unit.
- This unit operates on 220 V - 240 V AC, 50/60 Hz. Check that the unit's operating voltage is identical with your local power supply.
- Install this unit so that the mains lead can be unplugged from the wall socket immediately in the event of trouble.
- 5,150 - 5,350 MHz band is restricted to indoor operations only.
- This equipment has been tested and found to comply with the limits set out in the EMC Directive using a connection cable shorter than 3 metres.
- To reduce the risk of fire, do not cover the ventilation opening of the appliance with newspapers, tablecloths, curtains, etc.
- Do not expose the appliance to naked flame sources (for example, lighted candles).
- Do not install this player in a confined space, such as a bookshelf or similar unit.
- If the player is brought directly from a cold to a warm location, or is placed in a very damp room, moisture may condense on the lenses inside the player. Should this occur, the player may not operate properly. In this case, remove the disc and leave the player turned on for about half an hour until the moisture evaporates.
- The player is not disconnected from the AC power source (mains) as long as it is connected to the wall outlet, even if the player itself has been turned off.

Notice for the customers in Europe



This product is intended to be used in the following countries:

AT, BA, BE, BG, CH, CY, CZ, DE, DK, EE, ES, FI, FR, GB, GR, HR, HU, IE, IS, IT, LI, LT, LU, LV, MD, ME, MK, MT, NL, NO, PL, PT, RO, RS, SE, SI, SK.

Hereby, Sony Corporation declares that this equipment is compliance with the essential requirements and other relevant provisions of Directive 1999/5/EC. For details, please access the following URL: <http://www.compliance.sony.de/>

On AC adaptor

- Use the supplied AC adaptor for this player, as other adaptors may cause a malfunction.
- Do not disassemble or reverse-engineer.
- Do not confine the AC adaptor in a closed place such as a bookshelf or an AV cabinet.
- Do not connect the AC adaptor to a traveler's electric transformer, which may generate heat and cause a malfunction.
- Do not drop or apply shock.

Copyrights and Trademarks

- Java is a trademark of Oracle and/or its affiliates.

- Manufactured under license from Dolby Laboratories. Dolby and the double-D symbol are trademarks of Dolby Laboratories.
- For DTS patents, see <http://patents.dts.com>. Manufactured under license from DTS Licensing Limited. DTS, the Symbol, & DTS and the Symbol together are registered trademarks, and DTS 2.0+Digital Out is a trademark of DTS, Inc. © DTS, Inc. All Rights Reserved.



- The terms HDMI[®] and HDMI High-Definition Multimedia Interface, and the HDMI Logo are trademarks or registered trademarks of HDMI Licensing LLC in the United States and other countries.
- Blu-ray Disc[™], Blu-ray[™], BD-LIVE[™], BONUSVIEW[™], and the logos are trademarks of the Blu-ray Disc Association.
- Blu-ray 3D[™] and Blu-ray 3D[™] logo are trademarks of the Blu-ray Disc Association.



- "DVD Logo" is a trademark of DVD Format/Logo Licensing Corporation.
- "DVD+RW," "DVD-RW," "DVD+R," "DVD-R," "DVD VIDEO," "Super Audio CD," and "CD" logos are trademarks.
- "BRAVIA" is a trademark of Sony Corporation.
- MPEG Layer-3 audio coding technology and patents licensed from Fraunhofer IIS and Thomson.
- This product incorporates proprietary technology under license from Verance Corporation and is protected by U.S. Patent 7,369,677 and other U.S. and worldwide patents issued and pending as well as copyright and trade secret protection for certain aspects of such technology. Cinavia is a trademark of Verance Corporation. Copyright 2004-2010 Verance Corporation. All rights reserved by Verance. Reverse engineering or disassembly is prohibited.
- Windows Media is either a registered trademark or trademark of Microsoft Corporation in the United States and/or other countries. This product is protected by certain intellectual property rights of Microsoft Corporation. Use or distribution of such technology outside of this product is prohibited without a license from Microsoft or an authorized Microsoft subsidiary. Content owners use Microsoft PlayReady[™] content access technology to protect their intellectual property, including copyrighted content. This device uses PlayReady technology to access PlayReady-protected content and/or WMDRM-protected content. If the device fails to properly enforce restrictions on

content usage, content owners may require Microsoft to revoke the device's ability to consume PlayReady-protected content. Revocation should not affect unprotected content or content protected by other content access technologies. Content owners may require you to upgrade PlayReady to access their content. If you decline an upgrade, you will not be able to access content that requires the upgrade.

- Gracenote, the Gracenote logo and logotype, "Powered by Gracenote", Gracenote MusicID, Gracenote VideoID, and Gracenote Video Explore are either registered trademarks or trademarks of Gracenote, Inc. in the United States and/or other countries.



- Wi-Fi[®], Wi-Fi Protected Access[®] and Wi-Fi Alliance[®] are registered trademarks of Wi-Fi Alliance.
- Wi-Fi CERTIFIED[™], WPA[™], WPA2[™], Wi-Fi Protected Setup[™], Miracast[™] and Wi-Fi CERTIFIED Miracast[™] are trademarks of Wi-Fi Alliance.
- The Wi-Fi CERTIFIED Logo is a certification mark of Wi-Fi Alliance.
- The Wi-Fi Protected Setup Identifier Mark is a certification mark of the Wi-Fi Alliance.
- DLNA[™], the DLNA Logo and DLNA CERTIFIED[™] are trademarks, service marks, or certification marks of the Digital Living Network Alliance.



- The Bluetooth[®] word mark and logos are registered trademarks owned by Bluetooth SIG, Inc. and any use of such marks by Sony Corporation is under license. Other trademarks and trade names are those of their respective owners.
- LDAC[™] and LDAC logo are trademarks of Sony Corporation.
- "PS", "PlayStation" and "DUALSHOCK" are trademarks of Sony Computer Entertainment Inc.
- Opera[®] Devices SDK from Opera Software ASA. Copyright 1995-2015 Opera Software ASA. All rights reserved.



- All other trademarks are trademarks of their respective owners.

- Other system and product names are generally trademarks or registered trademarks of the manufacturers. [™] and [®] marks are not indicated in this document.

Gracenote[®] End User License Agreement

This application or device contains software from Gracenote, Inc. of Emeryville, California ("Gracenote"). The software from Gracenote (the "Gracenote Software") enables this application or device to perform disc and/or file identification and obtain music- and/or video-related information, including name, artist, track, and title information ("Gracenote Data") from online servers or embedded databases (collectively, "Gracenote Servers"), and to perform other functions. You may use Gracenote Data only by means of the intended End-User functions of this application or device; the reception and display of the Gracenote Data on this application or device are not provided by Gracenote and falls solely within the responsibility and liability of the manufacturer hereof.

This application or device may contain content belonging to Gracenote's providers. If so, all of the restrictions set forth herein with respect to Gracenote Data shall also apply to such content, and said content providers shall be entitled to all of the benefits and protections that are available to Gracenote hereunder. You agree that you will use Gracenote Data, the Gracenote Software, and Gracenote Servers for your own personal, non-commercial use only. You agree not to assign, copy, transfer or transmit the Gracenote Software or any Gracenote Data to any third party. **YOU AGREE NOT TO USE OR EXPLOIT GRACENOTE DATA, THE GRACENOTE SOFTWARE, OR GRACENOTE SERVERS EXCEPT AS EXPRESSLY PERMITTED HEREIN.**

You agree that your non-exclusive license to use the Gracenote Data, the Gracenote Software, and Gracenote Servers will terminate if you violate these restrictions. If your license terminates, you agree to cease any and all use of the Gracenote Data, the Gracenote Software, and Gracenote Servers. Gracenote reserves all rights in Gracenote Data, the Gracenote Software, and the Gracenote Servers, including all ownership rights. Under no circumstances will Gracenote become liable for any payment to you for any information that you provide. You agree that Gracenote may enforce its rights under this Agreement against you directly in its own name. Gracenote may amend or remove Gracenote Data with or without advance notice and may block or modify access to Gracenote Data; you do not have any claim against Gracenote arising out of such change, removal, blocking or modification.

PLEASE NOTE that in order to use the Gracenote Data, specific technical pre-requisites, such as this application or device, software programs, methods of transfer, telecommunication services and other third party services, usually need to be used, for which additional cost, in particular connection charges, can be incurred, which you will have to pay for separately. Gracenote does not provide such applications or devices, software programs, methods of transfer, telecommunication services or other services, and does not accept any liability for services of third parties. Gracenote is not responsible for the proper setup, connection or (if applicable) equipment of this application or device so that Gracenote Data may be received; this lies within your sole responsibility.

The Gracenote service uses a unique identifier to track queries for statistical purposes. The purpose of a randomly assigned numeric identifier is to allow the Gracenote service to count queries without knowing anything about who you are. For more information, see the web page for the Gracenote Privacy Policy for the Gracenote service.

The Gracenote Software and each item of Gracenote Data are licensed to you “AS IS.” Gracenote makes no representations or warranties, express or implied, regarding the accuracy of any Gracenote Data from the Gracenote Servers; the download or any other receipt of content, in particular the download of Gracenote Data, is also at your own risk and you are solely responsible for any damage to this application or device or for any other damages, including loss of data, arising out of such actions. Gracenote reserves the right to delete data from the Gracenote Servers or to change data categories for any cause that Gracenote deems sufficient. No warranty is made that the Gracenote Software or Gracenote Servers are error-free or that functioning of Gracenote Software or Gracenote Servers will be uninterrupted. Gracenote is not obligated to provide you with new, enhanced or additional data types or categories that Gracenote may provide in the future, and is free to discontinue its services at any time.

GRACENOTE DISCLAIMS ALL WARRANTIES EXPRESS OR IMPLIED, INCLUDING, BUT NOT LIMITED TO, IMPLIED WARRANTIES OF MERCHANTABILITY, FITNESS FOR A PARTICULAR PURPOSE, TITLE, AND NON-INFRINGEMENT. GRACENOTE DOES NOT WARRANT THE RESULTS THAT WILL BE OBTAINED BY YOUR USE OF THE GRACENOTE SOFTWARE, GRACENOTE DATA OR ANY GRACENOTE SERVER. IN NO CASE WILL GRACENOTE BE LIABLE FOR ANY CONSEQUENTIAL OR INCIDENTAL DAMAGES OR FOR ANY LOST PROFITS OR LOST REVENUES.

© 2000 – present. Gracenote, Inc. All Rights Reserved.

Software License Information

For EULA (End User License Agreement), please refer to [License agreement] in the option menu on each network service icon.

For details of the other software licenses, please select [Setup] and refer to [Software License Information] in [System Settings].

This product contains software that is subject to the GNU General Public License (“GPL”) or GNU Lesser General Public License (“LGPL”). These licenses establish that customers have the right to acquire, modify, and redistribute the source code of said software in accordance with the terms of the GPL or the LGPL.

The source code for the software used in this product is subject to the GPL and LGPL, and is available on the Web. To download, please visit the following website: <http://oss.sony.net/Products/Linux>

Please note that Sony cannot respond to any inquiries regarding the content of this source code.



Disclaimer regarding services offered by third parties

Services offered by third parties may be changed, suspended, or terminated without prior notice. Sony does not bear any responsibility in these sorts of situations.

Remote

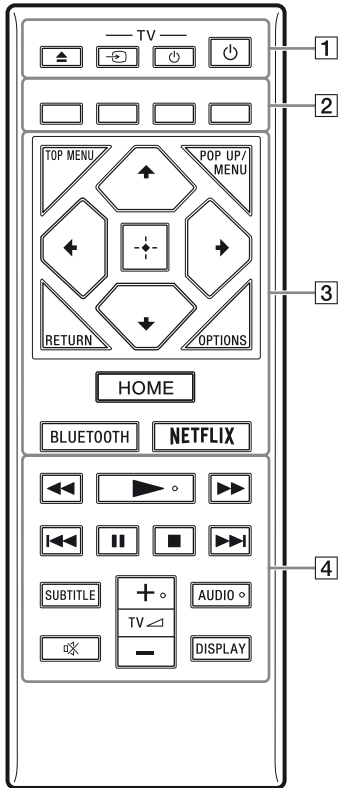
The available functions of the remote are different depending on the disc or the situation.



 , TV  +, and AUDIO buttons have a tactile dot. Use the tactile dot as a reference when operating the player.

- 1**  **(open/close)**
Opens or closes the disc tray.

-TV-  **(TV input select)**
Switches between TV and other input sources.

-TV-  **(TV on/standby)**
Turns on the TV, or sets to standby mode.

 **(on/standby)**
Turns on the player, or sets to standby mode.
- 2** **Colour buttons (red/green/yellow/blue)**
Shortcut keys for interactive functions.
- 3** **TOP MENU**
Opens or closes the BD's or DVD's Top Menu.

POP UP/MENU
Opens or closes the BD-ROM's Pop-up Menu, or the DVD's menu.



OPTIONS
Displays the available options on the screen.

RETURN
Returns to the previous display.



Moves the highlight to select a displayed item.



 -  as a shortcut key to launch track search window and input track number during music CD playback.
 -  as a shortcut key to rotate photo clockwise/counterclockwise by 90 degrees.
 -  as a shortcut key to perform search functions during DLNA video playback.

Centre button (ENTER)
Enters the selected item.

HOME
Enters the player's home screen.

BLUETOOTH

 - Scan device list will appear if this player has no paired Bluetooth device.
 - Connect to the last connected device if this player has a paired Bluetooth device. If the connection fails, scan device list will appear.
 - Disconnect the connected Bluetooth device.

NETFLIX

Accesses the “NETFLIX” online service. For further NETFLIX online service details, visit the following website and check the FAQ: www.sony.eu/support

4 ◀◀/▶▶ (fast reverse/fast forward)

- Fast reverse/fast forward the disc when you press the button during playback. The search speed changes each time you press the button during video playback.
- Plays in slow motion, when pressed for more than one second in pause mode.
- Plays one frame at a time, when you press for a short time in pause mode.

▶ (play)

Starts or re-starts playback.

◀◀/▶▶ (previous/next)

Skips to the previous/next chapter, track, or file.

|| (pause)

Pauses or re-starts playback.

■ (stop)

Stops playback and remembers the stop point (resume point).

The resume point for a title/track is the last point you played or the last photo for a photo folder.

SUBTITLE

Selects the subtitle language when multi-lingual subtitles are recorded on BD-ROMs/ DVD VIDEOS.

TV ⏏ (volume) +/-

Adjusts the TV volume.

AUDIO

Selects the language track when multi-lingual tracks are recorded on BD-ROMs/ DVD VIDEOS.

Selects the sound track on CDs.

🔇 (muting)

Turns off the sound temporarily.

DISPLAY

Displays the playback information on the screen.

To lock the disc tray (Child Lock)

You can lock the disc tray to avoid accidental opening of the tray.

While the player is turned on, press ■ (stop), HOME, and then TOP MENU button on the remote to lock or unlock the tray.

Code numbers of controllable TVs

Hold down -TV- ⏏ and the TV manufacturer's code using the remote buttons for 2 seconds.

If more than one remote button is listed, try entering them one at a time until you find the one that works with your TV.

Manufacturer	Remote Button
Sony (Default)	Colour button (red)
Philips	Colour button (green) / Colour button (yellow) / RETURN
Panasonic	Colour button (blue) / Centre button (ENTER)
Hitachi	TOP MENU
Sharp	↑
Toshiba	POP UP/MENU
Loewe	←
Samsung	→
LG/Goldstar	↓

Step 1: Connecting the Player

Do not connect the mains lead until you have made all the connections.

Connecting to your TV

Connect the player to your TV with a High Speed HDMI Cable.

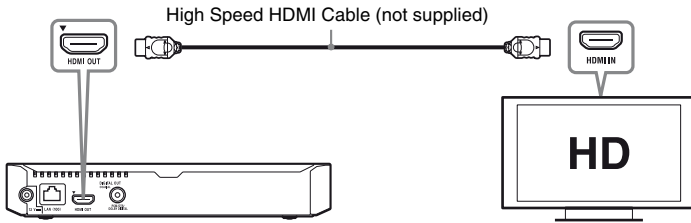

Connecting to your AV amplifier (receiver)

Select one of the following connection methods according to the input jacks on your AV amplifier (receiver). When you select **A** or **B**, make the appropriate settings in [Audio Settings].

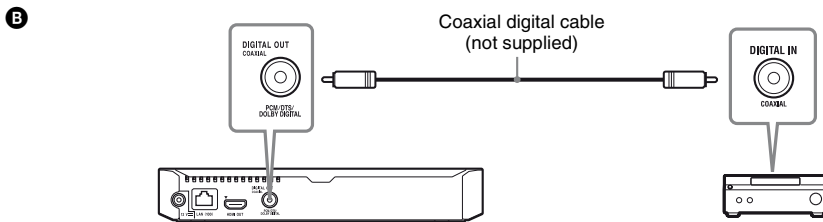
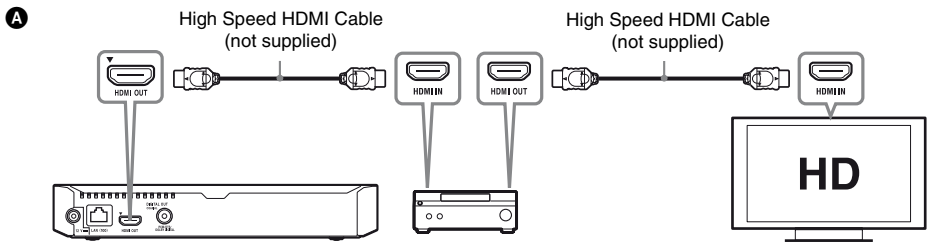

Step 2: Preparing for Network Connection

Wired Setup

Use a LAN cable to connect to the LAN (100) terminal on the player.

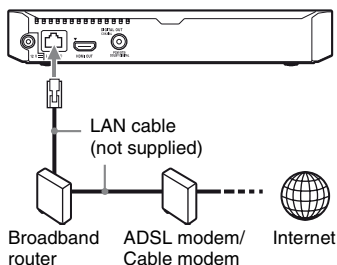

The use of a shielded and straight interface cable (LAN cable) is recommended.

Wireless Setup

Use the wireless LAN that is built into the player.

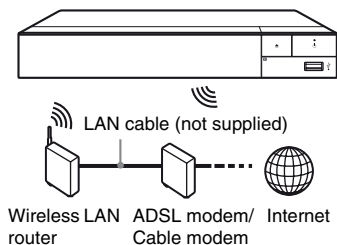

Step 3: Easy Setup

When turned on for the first time

Wait for a short while before the player turns on and starts [Easy Initial Settings].

- 1 Insert two R03 (size AAA) batteries by matching the \oplus and \ominus ends on the batteries to the markings inside the battery compartment of the remote.

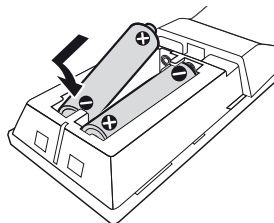

- 2 Connect the supplied AC adaptor and AC power cord (mains lead) in the numeric order shown below. When removing them, do so in reverse order.

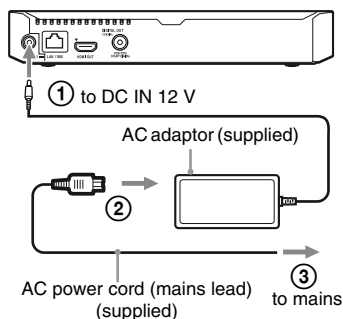

- 3 Press  to turn on the player.

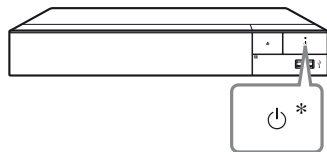

* Turns on the player, or sets to standby mode.

4 Turn on the TV and set the input selector on your TV by pressing  button on the remote. This will show the signal from the player on your TV screen.

5 Perform [Easy Initial Settings].

Follow the on-screen instructions to make the basic settings using  and ENTER on the remote.

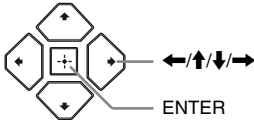

- When [Easy Initial Settings] is complete, select [Easy Network Settings] to use the network functions of the player.
- To enable wireless connection, set [Internet Settings] in [Network Settings] to [Wireless Setup].
- To disable wireless connection, set [Internet Settings] in [Network Settings] to [Wired Setup].

Home screen display

The home screen appears when you press HOME. Select an application using , and press ENTER.

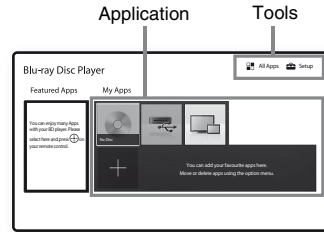

[My Apps]: Manages favourite application. You may add shortcuts for application from [All Apps].

[Featured Apps]: Displays recommended application.

[All Apps]: Shows all available applications. You can add applications to [My Apps] by pressing OPTIONS, and select [Add to My Apps].

[Setup]: Adjusts the player's settings.

Available options

Various settings and playback operations are available by pressing OPTIONS. The available items differ depending on the situation.

[Move Application]: Arranges applications in [My Apps].

[Remove Application]: Deletes applications in [My Apps].

[Data Contents]: Displays the contents of the mixed disc.

Playing a Disc

For “Playable discs”, see page 14.

- 1 Press **▲**, and place a disc on the disc tray.

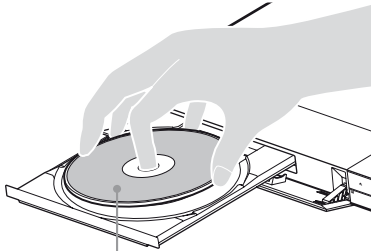

Playing side facing down

- 2 Press **▲** to close the disc tray.
Playback starts.
If playback does not start automatically, select [Video], [Music], or [Photo] category in **●** (Disc), and press ENTER.



● (Mixed disc) contains data contents. Press **OPTIONS** on the remote and select [Data Contents] to display any available contents.

Enjoying BONUSVIEW/BD-LIVE

- 1 **Connect a USB memory to the USB jack on the player.**
Use a 1 GB or larger USB memory as your local storage.
- 2 **Prepare for BD-LIVE (BD-LIVE only).**
 - Connect the player to a network (page 9).
 - Set [BD Internet Connection] in [BD/DVD Viewing Settings] to [Allow].

- 3 **Insert a BD-ROM with BONUSVIEW/BD-LIVE.**

The operation method differs depending on the disc. Refer to the instruction manual supplied with the disc.



To delete data in the USB memory, select [Delete BD Data] in [BD/DVD Viewing Settings], and press ENTER. All data stored in the buda folder will be erased.

Enjoying Blu-ray 3D







- 1 **Prepare for Blu-ray 3D Disc playback.**
 - Connect the player to your 3D-compatible devices using a High Speed HDMI Cable.
 - Set [3D Output Setting] and [TV Screen Size Setting for 3D] in [Screen Settings].
- 2 **Insert a Blu-ray 3D Disc.**
The operation method differs depending on the disc. Refer to the instruction manual supplied with the disc.



Refer also to the instruction manuals supplied with your TV and the connected device.

Playing from a USB Device

For “Playable types of files”, see page 15.

- 1 **Connect the USB device to the USB jack on the player.**
- 2 **Select  [USB device] using , and press ENTER.**
- 3 **Select [Video], [Music], or [Photo] category using , and press ENTER.**

Playing via a Network

Using “TV SideView”

“TV SideView” is a free mobile application for remote devices (such as smartphone, etc.). By using “TV SideView” with this player, you can easily enjoy the player by using the operation on your remote device. You can launch a service or application directly from the remote device and view the disc information during disc playback. “TV SideView” also can be used as a remote control and software keyboard. Before you use the “TV SideView” device with this player for the first time, be sure to register the “TV SideView” device. Follow the on-screen instructions on the “TV SideView” device for registration.



The registration can only be performed on the home screen.

Using Screen mirroring

“Screen mirroring” is a function to display the screen of a mobile device on the TV by Miracast technology.

The player can be connected directly with a Screen mirroring compatible device (e.g. smartphone, tablet). You can enjoy the display screen of the device on your large TV screen. No wireless router (or access point) is required to use this feature.



- When using Screen mirroring, the quality of picture and sound may sometimes be deteriorated due to interference from other network. You may improve by adjusting [Screen mirroring RF Setting].
- Some network functions may not be available during Screen mirroring.
- Make sure that the device is compatible with Miracast. Connectivity with all Miracast compatible devices is not guaranteed.

1 Select [Screen mirroring] from home screen using ///, and press ENTER.

2 Follow the on-screen instructions.

Listening to Audio from a Bluetooth Device

To listen to an audio source from a Bluetooth device (e.g. headphone) via this player, you need to pair the Bluetooth device with this player.

Pairing with a Bluetooth device

Pairing is an operation where the Bluetooth devices are registered to each other before connection. Set [Bluetooth Mode] in [Bluetooth Settings] to [On] before pairing a Bluetooth device with this player.

1 Place the Bluetooth device within 1 meter from the player.

2 Perform any of the following steps:

- When connecting to a device for the first time, press BLUETOOTH button on the remote.
- Select [Bluetooth Device] option on the playback screen.
- Select [Device List] in [Bluetooth Settings].

3 Set the Bluetooth device in pairing mode.

For details on setting the Bluetooth device in pairing mode, refer to the instruction manual supplied with the device.

4 Press / repeatedly to select the device you want, and press ENTER.

When the Bluetooth connection is established, the device name will appear on the TV screen.

5 Start playback content.

6 Adjust the volume.

Adjust the volume of the Bluetooth device first. If the volume level is still low, adjust the volume level by selecting [Bluetooth Volume] option on the playback screen. Press / to adjust the volume.



Some Bluetooth device does not support volume control.

To disconnect the Bluetooth device



Perform any of the following steps:

- Press BLUETOOTH button on the remote (page 6).
- Disable the Bluetooth function on the Bluetooth device.
- Turn off the player or the Bluetooth device.



Before you turn off your Bluetooth device, turn down the volume level of your TV to avoid sudden high volume outbursts.

Software Update

- 1 Select  [Setup] on the home screen using /↑/↓/→.
- 2 Select  [Software Update] using ↑/↓, and press ENTER.

■ [Update via Internet]

Updates the player's software using available network. Make sure that the network is connected to the Internet. For details, see "Step 2: Preparing for Network Connection" (page 9).

■ [Update via USB Memory]

Updates the player's software using USB memory. Make sure that the Software Update Folder is correctly named as "UPDATE" and all the update files must be stored in this folder. The player can recognise up to 500 files/folders in a single layer including the update files/folders.



- We recommend performing the software update every 2 months or so.
- If your network condition is poor, visit www.sony.eu/support to download the latest software version and update via USB memory. You can also get information about update functions from the website.

Playable discs

Blu-ray Disc *1	BD-ROM, BD-R*2/ BD-RE*2
DVD *3	DVD-ROM, DVD-R/ DVD-RW, DVD+R/ DVD+RW
CD *3	CD-DA (Music CD), CD-ROM, CD-R/CD-RW Super Audio CD

*1 Since the Blu-ray Disc specifications are new and evolving, some discs may not be playable depending on the disc type and the version. The audio output differs depending on the source, connected output jack, and selected audio settings.

*2 BD-RE: Ver.2.1, BD-R: Ver.1.1, 1.2, 1.3 including organic pigment type BD-R (LTH type). The BD-Rs recorded on a PC cannot be played if postscripts are recordable.

*3 A CD or DVD disc will not play if it has not been correctly finalised. For more information, refer to the instruction manual supplied with the recording device.

Region code (BD-ROM/DVD VIDEO only)

Your player has a region code printed on the bottom of the unit and will only play BD-ROMs/DVD VIDEOS labeled with identical region codes or .



Region code

Playable types of files

Video

Codec	Container	Extension	With Audio
MPEG-1 Video* ¹	PS	.mpg, .mpeg	Dolby Digital, DTS, LPCM, MPEG
	MKV	.mkv	Dolby Digital, LPCM, AAC, MP3, Vorbis
MPEG-2 Video* ²	PS* ³	.mpg, .mpeg	Dolby Digital, DTS, LPCM, MPEG
	TS* ⁴	.m2ts, .mts	Dolby Digital, DTS, LPCM, MPEG, AAC
Xvid	MKV* ¹	.mkv	Dolby Digital, LPCM, AAC, MP3, Vorbis
	AVI	.avi	Dolby Digital, LPCM, WMA9, MP3
MPEG4/AVC* ⁵	MKV* ¹	.mkv	Dolby Digital, LPCM, AAC, MP3, Vorbis
	MP4* ¹	.mp4, .m4v	AAC
	TS* ¹	.m2ts, .mts	Dolby Digital, DTS, LPCM, MPEG, AAC
	Quick Time* ⁶	.mov	Dolby Digital, LPCM, AAC, MP3
	FLV* ⁶	.flv, .f4v	LPCM, AAC, MP3
	3gpp/3gpp2* ⁶	.3gp, .3g2, .3gpp, .3gp2	AAC
VC1* ¹	TS	.m2ts, .mts	Dolby Digital, DTS, LPCM, MPEG, AAC
	MKV	.mkv	Dolby Digital, LPCM, AAC, MP3, Vorbis
WMV9* ^{1*7}	ASF	.wmv, .asf	WMA9, WMA 10 Pro
	MKV	.mkv	Dolby Digital, LPCM, AAC, MP3, Vorbis
Motion JPEG* ⁶	Quick Time	.mov	Dolby Digital, LPCM, AAC, MP3
	AVI	.avi	Dolby Digital, LPCM, AAC, MP3

Format

AVCHD (Ver.2.0)*^{1*8*9*10}

Music

Codec	Extension
MP3 (MPEG-1 Audio Layer III)* ¹¹	.mp3
AAC/HE-AAC* ^{1*11}	.m4a, .aac* ⁶
WMA9 Standard* ¹	.wma
WMA 10 Pro* ¹²	.wma
LPCM* ¹¹	.wav
FLAC* ¹	.flac, .fla
Dolby Digital* ^{6*11}	.ac3
DSF* ¹	.dsf
DSDIFF* ^{1*13}	.dff

Music

Codec	Extension
AIFF* ¹	.aiff, .aif
ALAC* ¹	.m4a
Vorbis	.ogg
Monkey's Audio	.ape

Photo

Format	Extension
JPEG	.jpeg, .jpg, .jpe
PNG	.png* ¹⁴
GIF	.gif* ¹⁴
MPO	.mpo* ^{6*15}
BMP	.bmp* ^{6*16}

- *1 The player may not play this file format on a DLNA server.
- *2 The player can only play standard definition video on a DLNA server.
- *3 The player does not play DTS format files on a DLNA server.
- *4 The player can only play Dolby Digital format files on a DLNA server.
- *5 The player can support AVC up to Level 4.1.
- *6 The player does not play this file format on a DLNA server.
- *7 The player can support WMV9 up to Advance Profile.
- *8 The player can support frame rate up to 60 fps.
- *9 The player plays AVCHD format files that are recorded on a digital video camera, etc. The AVCHD format disc will not play if it has not been correctly finalised.
- *10 The player can play AVCHD 3D format.
- *11 The player can play “.mka” files.
This file cannot be played on a DLNA server.
- *12 The player does not play coded file such as Lossless.
- *13 The player does not play DST encoded files.
- *14 The player does not play animated PNG or animated GIF files.
- *15 For MPO files other than 3D, the key image or the first image is displayed.
- *16 The player does not support 16bit BMP files.



- Some files may not play depending on the file format, file encoding, recording condition, or DLNA server condition.
- Some files edited on a PC may not play.
- Some files may not be able to perform fast forward or fast reverse function.
- The player does not play coded files such as DRM.
- The player can recognise the following files or folders in BDs, DVDs, CDs and USB devices:
 - up to folders in the 9th layer, including the root folder
 - up to 500 files/folders in a single layer
- The player can recognise the following files or folders stored in the DLNA server:
 - up to folders in the 19th layer
 - up to 999 files/folders in a single layer
- The player can support frame rate:
 - up to 60 fps for AVCHD (MPEG4/AVC) only.
 - up to 30 fps for other video codecs.
- The player can support video bit rate up to 40 Mbps.
- Some USB devices may not work with this player.
- The player can recognise Mass Storage Class (MSC) devices (such as flash memory or an HDD), Still Image Capture Device (SICD) class devices and 101 keyboard.
- To avoid data corruption or damage to the USB memory or devices, turn off the player when connecting or removing the USB memory or devices.

Specifications

System

Laser	Semiconductor laser
--------------	---------------------

Inputs and outputs

DIGITAL OUT (COAXIAL) (Jack name)	Phono jack /0.5 Vp-p/75 ohms (Jack type/Output level/Load impedance)
HDMI OUT	HDMI 19-pin standard connector
LAN (100)	100BASE-TX Terminal
USB	USB jack Type A (For connecting a USB memory, memory card reader, digital still camera, and digital video camera)* * Do not use for power charging purposes.
DC IN	12 V DC, 850 mA

Wireless

Wireless LAN standard	Protocol IEEE802.11 a/b/g/n
Frequency range	2.4 GHz, 5 GHz band
Modulation	DSSS and OFDM
Bluetooth Version	Bluetooth Version 4.1

Bluetooth

Communication system	Bluetooth Specification v4.1
Output	Bluetooth Specification Power Class 1
Maximum communication range	Line of sight approx. 30 m
Frequency band	2.4 GHz
Modulation method	FHSS
Compatible Bluetooth Profiles	A2DP v1.2, AVRCP v1.3
Supported Codecs	SBC, AAC, LDAC
Transmission range (A2DP)	<ul style="list-style-type: none">• 20 Hz - 40,000 Hz (LDAC in sampling 96 kHz and transmit by 990 kbps)• 20 Hz - 20,000 Hz (in sampling 44.1 kHz)

General

Power requirements	12 V DC with AC adaptor Rating: Input 220 V - 240 V AC, 50/60 Hz
Power consumption (when using AC adaptor)	12 W
Network standby^{*1*2}	Less than 3 W (all wired/wireless network ports ON)
Dimensions (approx.)	255 mm x 192 mm x 39 mm (width/depth/height) incl. projecting parts

Mass (approx.)	0.9 kg
Operating temperature	5 °C to 35 °C
Operating humidity	25 % to 80 %

*1 Set [Remote Start] in [Network Settings] to [On] and turn off the player to activate Network standby.

*2 Set [Bluetooth Mode] and [Bluetooth Standby] in [Bluetooth Settings] to [On] and turn off the player to activate Network standby.

Supplied accessories

- AC adaptor (AC-L1210WW) (1)
- AC power cord (mains lead) (1)
- Remote commander (remote) (1)
- R03 (size AAA) batteries (2)

Specifications and design are subject to change without notice.



To find out useful hints, tips and information about Sony products and services please visit: www.sony.eu/myproducts/



<http://www.sony.net/>

4-579-667-12(1)

© 2016 Sony Corporation
Printed in Malaysia

