



Built from experience



# USER GUIDE & INSTALLATION INSTRUCTIONS

Classic - 3 button clock | Classic Deluxe |  
Kitchener | Professional+  
110 Ceramic

U110767-02

Show off your kitchen with ...

# This is #MyRangemaster



Simply snap and share a picture of your kitchen and tag #MyRangemaster for the chance to win £200 of Rangemaster cookware. If selected we will also send a photographer round to professionally photograph you at home with your range. You might even feature in some of the UK's top home interest titles!

To enter all you have to do is send in photos of your Rangemaster kitchen and tell us in one sentence **what makes Rangemaster the heart of your kitchen?** Entries can be posted on our Facebook page, Instagram or Twitter by tagging @RangemasterUK and using #MyRangemaster. Or, if you prefer, simply send in your entry via e-mail to [marketing@agarangemaster.co.uk](mailto:marketing@agarangemaster.co.uk).

Rangemaster will feature a number of entries on the website online gallery and on the Rangemaster Facebook page, and some kitchens may be selected to be professionally photographed.

\*Terms & Conditions Apply

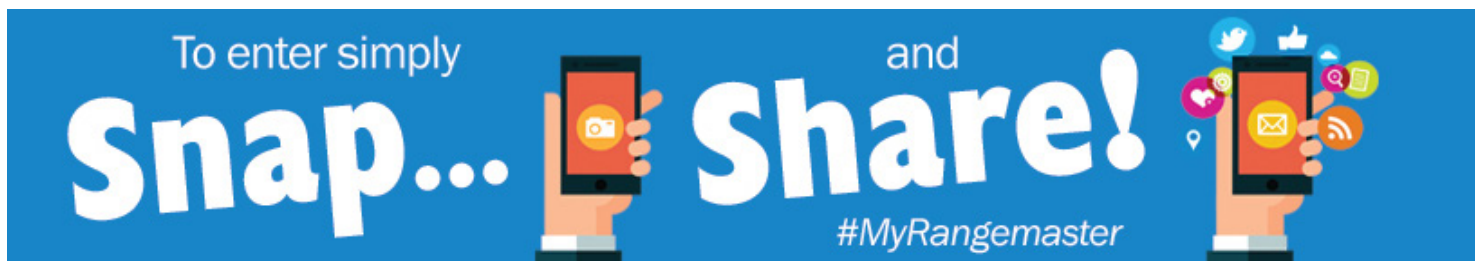

## RANGEMASTER COOKWARE

Our range cookers are well known for providing the best possible cooking performance and years of faithful service.

However, a great cooker alone cannot guarantee perfect results every time. The other vital ingredients are of course enthusiasm and quality cookware.

We offer cookware to work perfectly with all fuel types manufactured by Rangemaster, including induction hobs. You can be assured of functionality with style, as well as the quality and meticulous attention to detail you expect from the pioneers of range cooking.

Visit [www.rangemastercookshop.co.uk](http://www.rangemastercookshop.co.uk)



#### \*Terms & Conditions

1. This is my Rangemaster is open to residents of UK mainland only, aged 18 years & over. 2. All entries should be submitted to the advertised e-mail address, or Rangemaster UK Facebook, Instagram or Twitter page using the advertised hashtag & tag. 3. If we would like to professionally photograph your kitchen, you will be contacted via e-mail, Facebook / Twitter message or Instagram comment. 4. We cannot guarantee your kitchen will be professionally photographed. 4. Any photographs received and professional photographs taken will belong to AGA Rangemaster plc with full usage rights. E&OE.

# Contents

---

<b>1. Before you start...</b>	<b>1</b>	<b>7. Cooking Tips</b>	<b>21</b>
Personal safety	1	<b>8. Cooking Table</b>	<b>22</b>
Electrical connection safety	1	<b>9. Cleaning your cooker</b>	<b>23</b>
Peculiar smells	2	<b>10. Troubleshooting</b>	<b>27</b>
Ventilation	2	<b>11. Installation</b>	<b>29</b>
Maintenance	2	Dear Installer	29
Ceramic care	3	Safety requirements and regulations	29
Oven care	4	Provision of ventilation	29
Hob care	5	Location of cooker	29
Grill/glide-out grill™ care	5	Positioning the cooker	30
Cooling fan	5	Moving the cooker	30
Cooker care	5	Lowering the two rear rollers	31
Cleaning	5	Completing the move	31
<b>2. Cooker overview</b>	<b>6</b>	Repositioning the cooker following connection	31
The hob	6	Levelling the cooker	31
Dual purpose hob/warmer area knob overview	8	Electrical connection	32
Grill / Glide-out Grill™	9	Final checks	32
Accessories	10	Final fitting	33
<b>3. The ovens</b>	<b>11</b>	Customer care	33
<b>4. 2 Button - rotary clock</b>	<b>14</b>	<b>12. Circuit diagrams</b>	<b>34</b>
<b>5. 3 Button clock</b>	<b>17</b>	<b>13. Technical data</b>	<b>38</b>
<b>6. 6 Button clock</b>	<b>19</b>		



# 1. Before you start...

---

**This User Guide covers a number of different models. Although some of the illustrations will look different to your particular model the functions will be the same.**

Your cooker should give you many years of trouble-free cooking if installed and operated correctly. It is important that you read this section before you start.

## Personal safety

This appliance is for cooking purposes only. It must not be used for other purposes, for example heating a room. Using it for any other purpose could invalidate any warranty or liability claim. Besides invalidating claims this wastes fuel and may overheat the control knobs.

- This appliance can be used by children aged from 8 years and above and persons with reduced physical, sensory or mental capabilities or lack of experience and knowledge if they have been given supervision or instruction concerning use of the appliance in a safe way and understand the hazards involved.
- Children **less** than 8 years of age should be kept away unless continuously supervised. Children shall not play with the appliance. Cleaning and user maintenance shall not be made by children without supervision.
- This appliance is designed for domestic cooking only. Use for any other purpose could invalidate any warranty or liability claim.
- The appliance and its accessible parts become hot during use and will retain heat even after you have stopped cooking. Care should be taken to avoid touching heating elements.
- A long term cooking process has to be supervised from time to time. A short term cooking process has to be supervised continuously.
- **DANGER OF FIRE: DO NOT** store items on the cooking surfaces.
- To avoid overheating, **DO NOT** install the cooker behind a decorative door.
- Accessible parts will become hot during use and will retain heat even after you have stopped cooking. Keep babies and children away from the cooker and never wear loose-fitting or hanging clothes when using the appliance.
- **DO NOT** use a steam cleaner on your cooker.
- **ALWAYS** keep combustible materials, e.g. curtains, and flammable liquids a safe distance away from your cooker.
- **DO NOT** spray aerosols in the vicinity of the cooker while it is on.

## Electrical connection safety

The electrical installation must be installed in accordance with all relevant British Standards/Codes of Practice, BS 7671. Or with the relevant national and local regulations and with the local gas and electricity supply companies' requirements.

Otherwise, all installations must be in accordance with the relevant instructions in this booklet.

Read the instructions before installing or using this appliance.

- This appliance is heavy so take care when moving it.
- The cooker may be installed in a kitchen/kitchen diner but **NOT** in a room containing a bath or shower.
- This appliance **MUST** be earthed.
- The cooker **MUST NOT** be connected to an ordinary domestic power point.
- It is normal for the hob control display to flash for about 2 seconds during first power setting.
- Set the clock to make sure that the oven is functional – see the relevant section in this manual.
- The appliance must be installed in accordance with the regulations in force and only in a well ventilated space.
- Failure to install the appliance correctly could invalidate any warranty or liability claims and lead to prosecution.
- **DO NOT** install the appliance on a platform.
- **DO NOT** manouvre the cooker while it is plugged into the electricity supply.
- Before electrical reconnection, check that the appliance is electrically safe.

## Peculiar smells

When you first use your cooker it may give off an odour. This should stop after use.

Before using your cooker for the first time, make sure that all packing materials have been removed and then, to dispel manufacturing odours, turn all the ovens to 200°C and run for at least an hour.

Before using the grill for the first time you should also turn on the grill and run for 30 minutes with the grill pan in position, pushed fully back and the grill door open.

Make sure the room is well ventilated to the outside air (see 'Ventilation' below). People with respiratory or allergy problems should vacate the area for this brief period.

## Ventilation

The use of a cooking appliance results in the production of heat and moisture in the room in which it is installed. Make sure that the kitchen is well ventilated. Keep natural ventilation holes open or install a powered cooker hood that vents outside.

Prolonged intensive use of the appliance may call for additional ventilation, for example opening a window, or more effective ventilation, for example increasing the level of mechanical ventilation where present.

## Maintenance

- Only a qualified service engineer should service the appliance and only approved spare parts should be used. It is recommended that this appliance is serviced annually.
- **DO NOT** use cooking vessels on the hotplate that overlap the edges.
- **ALWAYS** allow the cooker to cool and then switch it off at the mains before cleaning or carrying out any maintenance work, unless specified otherwise in this guide.
- **DO NOT** use the control knobs to manoeuvre the cooker.
- **NEVER** operate the cooker with wet hands.
- **DO NOT** use a towel or other bulky cloth in place of a glove – it might catch fire if brought into contact with a hot surface.
- **DO NOT** use hotplate protectors, foil or hotplate covers of any description. These may affect the safe use of your hotplate burners and are potentially hazardous to health.
- **NEVER** heat unopened food containers. Pressure build up may make the containers burst and cause injury.
- **DO NOT** use unstable saucepans. **ALWAYS** make sure that you position the handles away from the edge of the hotplate.
- **NEVER** leave the hotplate unattended at high heat settings. Pans boiling over can cause smoking, and greasy spills may catch on fire. Use a deep fat thermometer whenever possible to prevent fat overheating beyond the smoking point.
- Unattended cooking on a hob with fat or oil can be dangerous and may result in fire.
- **NEVER** leave a chip pan unattended. **ALWAYS** heat fat slowly, and watch as it heats. Deep fry pans should be only one third full of fat.
- **NEVER** try to move a pan of hot fat, especially a deep fat fryer. Wait until the fat is cool. Filling the pan too full of fat can cause spill over when food is added. If you use a combination of oils or fats in frying, stir them together before heating, or as the fats melt.
- Foods for frying should be as dry as possible. Frost on frozen foods or moisture on fresh foods can cause hot fat to bubble up and over the sides of the pan. Carefully watch for spills or overheating of foods when frying at high or medium high temperatures.
- **DO NOT** use the top of the flue (the slots along the back of the cooker) for warming plates, dishes, drying tea towels or softening butter.
- **DO NOT** use water on grease fires and never pick up a flaming pan. Turn the controls off and then smother a flaming pan on a surface unit by covering the pan completely with a well fitting lid or baking tray. If available, use a multi-purpose dry chemical or foam-type fire extinguisher.
- **DO NOT** modify this appliance. This appliance is not intended to be operated by means of external timer or separated remote-control system.
- If flammable materials are stored in the drawer, oven(s) or grill(s) it may explode and result in fire or property damage.

## Ceramic care

- Take care when touching the marked cooking areas of the hob.
- Use adequately sized pans with flat bottoms that are large enough to cover the surface of the hotplate heating area. The use of undersized pans will expose a portion of the surface unit to direct contact and may result in the ignition of clothing.
- Only certain types of glass, glass-ceramic, earthenware or other glazed containers are suitable for use on the warming zone; others may break because of the sudden change in temperature.
- Only certain types stainless steel, enamelled steel pans or cast iron pans with enamelled bases are suitable for induction hob cooking.
- Take care **NOT** to scratch the surface when placing cookware on the glass panel.
- Only certain types of glass, glass-ceramic, earthenware or other glazed containers are suitable for hotplate cooking; others may break because of the sudden change in temperature. **NEVER** cook directly on the hob surface (**Fig. 1.1**).
- **DO NOT** leave the hob zones switched on unless being used for cooking.
- **DO NOT** stand or rest heavy objects on the hob. Although the ceramic surface is very strong, a sharp blow or sharp falling object (e.g. a salt cellar) might cause the surface to crack or break (**Fig. 1.2**).
- Should a crack appear in the surface, disconnect the appliance immediately from the supply and arrange for its repair.
- **ALWAYS LIFT** pans off the hob. Sliding pans may cause marks and scratches (**Fig. 1.3**).
- Take care **NOT TO PLACE HOT LIDS** onto the hob surface (**Fig. 1.4**). Lids that have been used to cover a hot pan can “stick” or create a “vacuum” effect to the Glass Hob. Should this occur, **DO NOT** attempt to lift the lid off the glass surface, this may damage the glass. Instead slide the lid to the edge of the hob surface and remove, taking care not to scratch the hob surface. Alternatively wait until the lid has cooled to room temperature, the vacuum has been released, then remove the lid by lifting it from the hob surface.
- **DO NOT** place anything between the base of the pan and the hob surface (e.g. asbestos mats, aluminium foil, wok stand).
- Take care **NOT** to place metallic objects such as knives, forks, spoons and lids on the hob surface since they can get hot.
- We recommend that you avoid wiping any surface unit areas until they have cooled and the indicator light

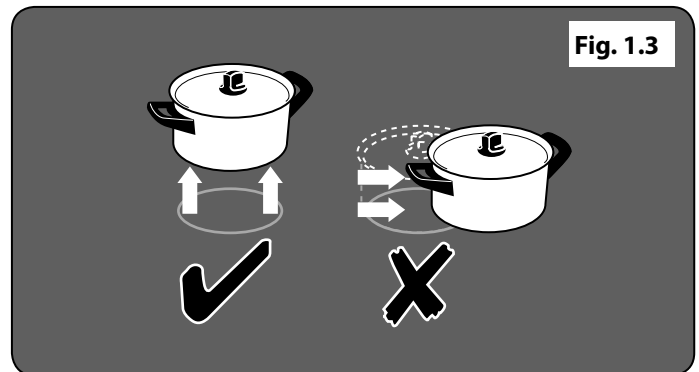
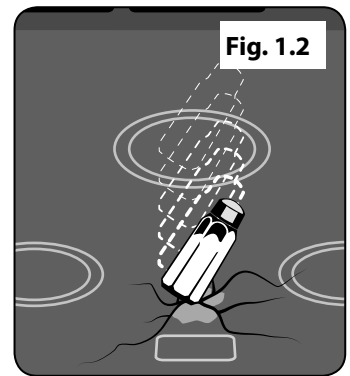
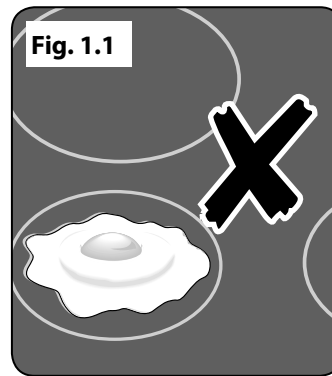

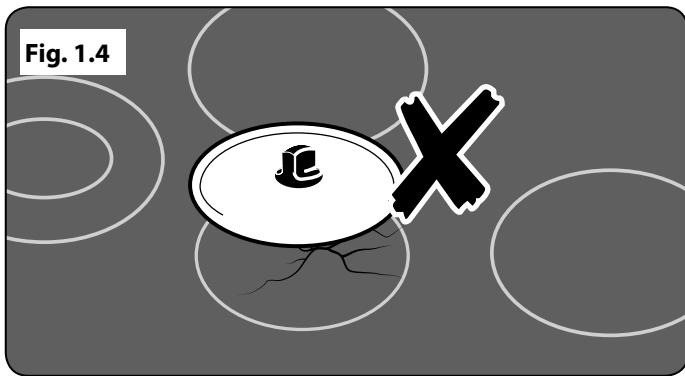

Fig. 1.4

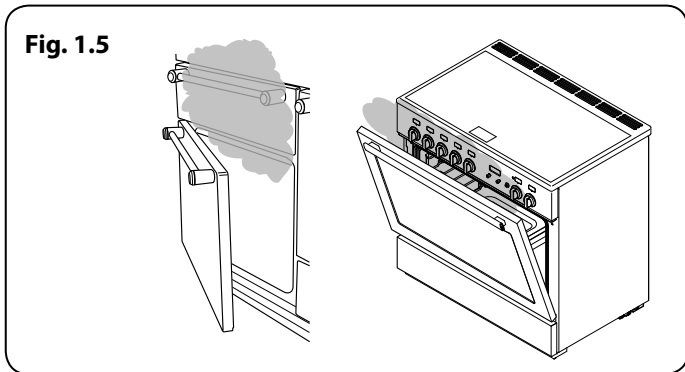

Fig. 1.5

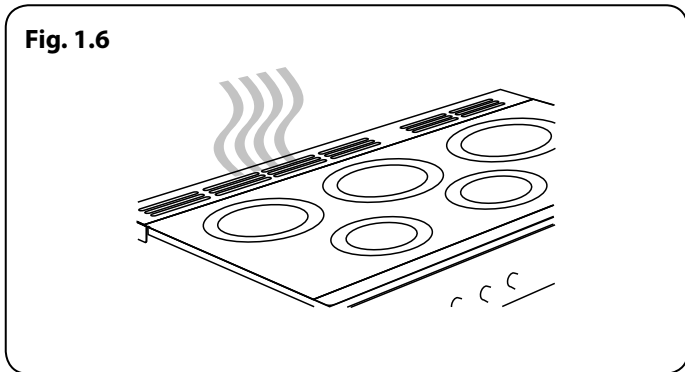

Fig. 1.6

has gone off. Sugar spills are the exception to this (see 'Cleaning your Cooker'). After cleaning, use a dry cloth or paper towel to remove any cleaning cream residue.

- The ceramic surface should be washed after use in order to prevent it from becoming scratched or dirty. However, you should clean the hob with caution as some cleaners can produce noxious fumes if applied to a hot surface.
- **DO NOT** leave the hob unattended. Care should be taken to not allow your cookware to boil dry. It will damage your cookware and Induction Glass Hob.
- After use, switch off the hob element by its control. **DO NOT** rely on the pan detector.

## Oven care

- When the oven is not in use and before attempting to clean the appliance **ALWAYS** be certain that the control knobs are in the **OFF** position.
- Use oven gloves to protect your hand from potential burns.
- Cooking high moisture content foods can create a 'steam burst' when the oven door is opened (**Fig. 1.5**). When opening the oven, stand well back and allow any steam to disperse.
- The inside door face is constructed with toughened safety glass. Take care **NOT** to scratch the surface when cleaning the glass panel.
- Accidental damage may cause the door glass panel to fracture.
- Keep oven vent ducts unobstructed.
- **DO NOT** use harsh abrasive cleaners or sharp metal scrapers to clean the oven door glass since they can scratch the surface, which may result in shattering of the glass.
- Make sure the shelves are pushed firmly to the back of the oven. **DO NOT** close the door against the oven shelves.
- **DO NOT** use aluminium foil to cover shelves, linings or the oven roof.
- When the oven is on, **DO NOT** leave the oven door open for longer than necessary, otherwise the control knobs may become very hot.
- **DO NOT** use the timed oven if the adjoining oven is already warm.
- **DO NOT** place warm food in the oven to be timed.
- **DO NOT** use a timed oven that is already warm.
- Use dry oven gloves when applicable – using damp gloves might result in steam burns when you touch a hot surface.



## Hob care

- **NEVER** allow anyone to climb or stand on the hob.
- **DO NOT** use the hob surface as a cutting board.
- **DO NOT** leave utensils, foodstuffs or combustible items on the hob when it is not in use (e.g. tea towels, frying pans containing oil).
- **DO NOT** place plastic or aluminium foil, or plastic containers on the hob.
- **ALWAYS** turn the control to the **OFF** position before removing a pan.
- Avoid heating an empty pan. Doing so may damage both the hob and pan.

## Grill/glide-out grill™ care

- When using the grill, make sure that the grill pan is in position and pushed fully in, otherwise the control knobs may become very hot.
- **DO NOT** leave the grill on for more than a few moments without the grill pan underneath it, otherwise the knobs may become hot.
- **NEVER** close the grill door when the grill is on.
- Accessible parts may be hot when the grill is in use. Young children should be kept away.

## Cooling fan

This appliance may have a cooling fan. When the grill or oven is in operation the fan will run to cool the fascia and control knobs.

## Cooker care

As steam can condense to water droplets on the cool outer trim of the oven, it may be necessary during cooking to wipe away any moisture with a soft cloth. This will also help to prevent soiling and discolouration of the oven exterior by cooking vapours (**Fig. 1.6**).

## Cleaning

- Isolate the electricity supply before carrying out any thorough cleaning. Allow the cooker to cool.
- In the interests of hygiene and safety, the cooker should be kept clean at all times as a build up in fats and other food stuff could result in a fire.
- Clean only the parts listed in this guide.
- Clean with caution. If a wet sponge or cloth is used to wipe spills on a hot surface, be careful to avoid steam burns. Some cleaners can produce noxious fumes if applied to a hot surface.
- **NEVER** use paint solvents, washing soda, caustic cleaners, biological powders, bleach, chlorine based bleach cleaners, coarse abrasives or salt.
- **DO NOT** mix different cleaning products – they may react together with hazardous results.
- All parts of the cooker can be cleaned with hot soapy water.
- Take care that no water seeps into the appliance.
- Before you remove any of the grill parts for cleaning, make sure that they are cool or use oven gloves.
- **DO NOT** use any abrasive substances on the grill and grill parts.
- **DO NOT** put the side runners in a dishwasher.
- **DO NOT** put the burner heads in a dishwasher.
- **NEVER** use caustic or abrasive cleaners as these will damage the surface.
- **DO NOT** use steel wool, oven cleaning pads or any other materials that will scratch the surface.
- **NEVER** store flammable materials in the drawer. This includes paper, plastic and cloth items, such as cookbooks, plastic ware and towels, as well as flammable liquids.
- **DO NOT** store explosives, such as aerosol cans, on or near the appliance.
- **DO NOT** use steel wool, oven cleaning pads, or any other materials that will scratch the surface.
- **DO NOT** attempt to disassemble or clean around any burner while another burner is on, otherwise an electric shock could result.

## 2. Cooker overview

Fig. 2.1

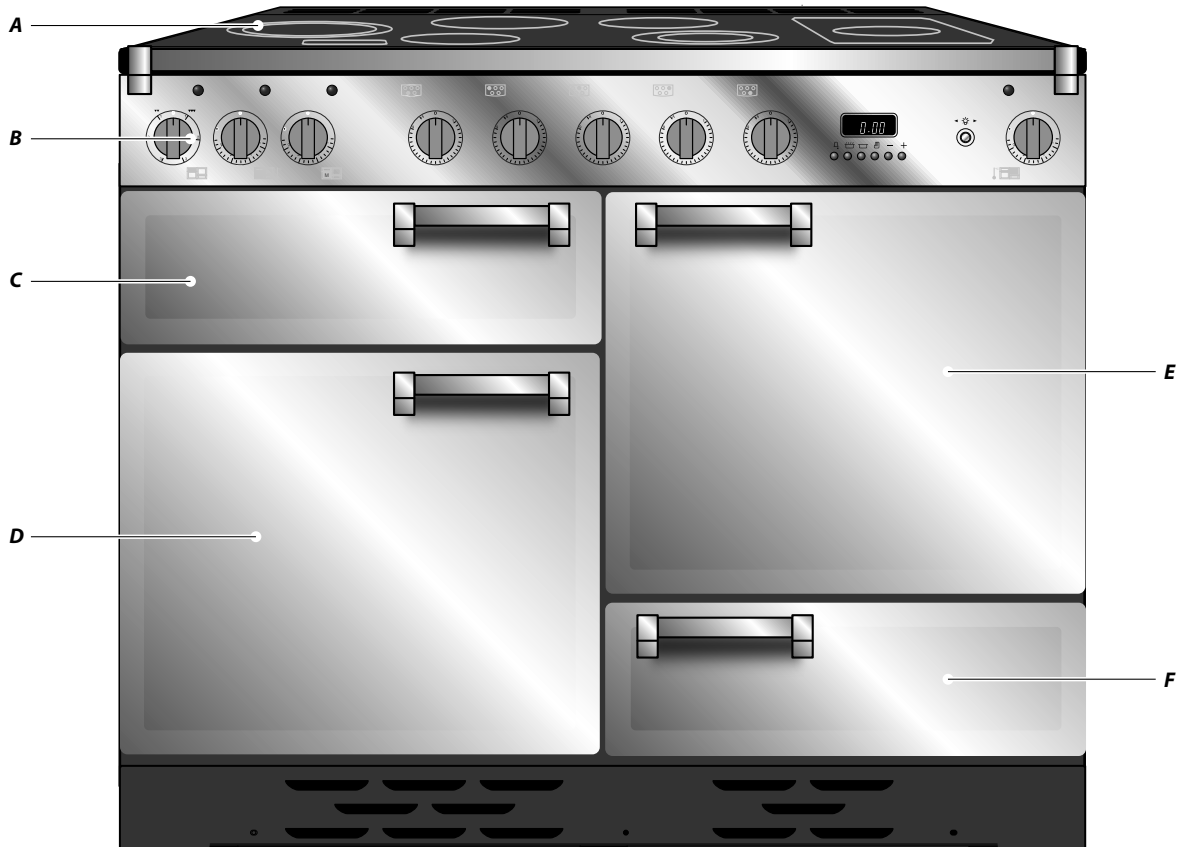

Fig. 2.2

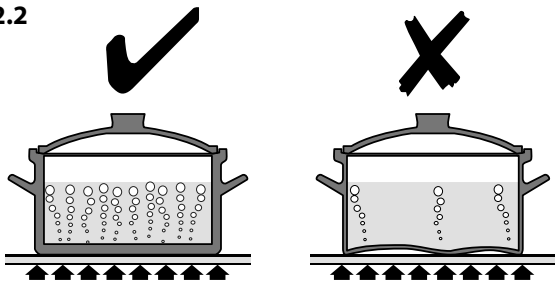

Fig. 2.3

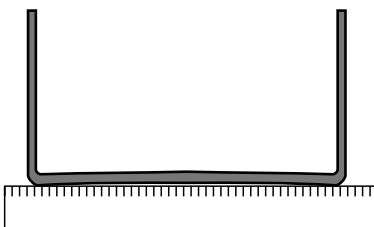
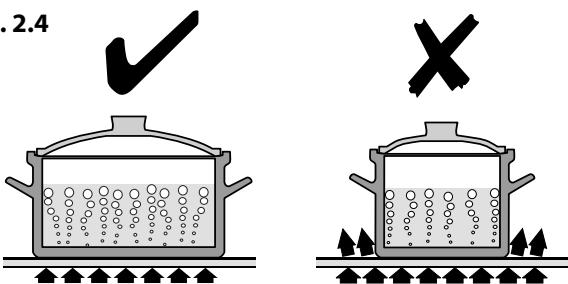

Fig. 2.4



The 110 ceramic cooker (Fig. 2.1) has the following features:

- A. Ceramic hob
- B. Control panel
- C. Separate grill or glide-out grill (depending on model)
- D.
 

<p><b>Zoned oven</b></p> <ul style="list-style-type: none"> <li>Kitchener</li> <li>Classic</li> <li>Professional+</li> </ul>	<p><b>Multi-function oven</b></p> <ul style="list-style-type: none"> <li>Classic Deluxe timed oven</li> </ul>
--	---
- E. Timed Fan oven (*not including Classic Deluxe*)
- F. Bread proving drawer

### The hob

Use only pans that are suitable for ceramic hobs. We recommend stainless steel and enamelled steel pans as pots and pans with copper or aluminium bases leave traces on the hob that are difficult to remove.

The kind of pan you use and the quantity of food affects the setting required. Higher settings are required for larger quantities of food.

Pots and pans should have thick, smooth, flat bottoms (Fig. 2.2). This allows the maximum heat transfer from the hob to the pan, making cooking quick and energy efficient. **NEVER** use a round-bottomed wok, even with a stand.

The very best pans have bases that are very slightly curved up when cold. If you hold a ruler across the bottom you will see a small gap in the middle (**Fig. 2.3**). When they heat up the metal expands and lies flat on the cooking surface.

Make sure that the base of the pan is clean and dry to prevent any residue burning onto the hob panel. This also helps prevent scratches and deposits.

**ALWAYS** use pans that are the same size as (or slightly larger than) the areas marked on the hob top (**Fig. 2.4**). Using smaller pans wastes heat, and any spillage will be burnt on. Using a lid will help the contents boil more quickly.

There are indicator lights for each of the cooking areas (**Fig. 2.5**). The lights come on when a hob control is turned on and stays lit while the surface cools.

**⚠ ALWAYS take care before touching the surface, even when the hob is turned off – it may be hotter than you think.**

The ratings of the different cooking areas are shown in (**Fig. 2.6**). These ratings are specified at 230 V.

When cooking on the hob, you may see the hob area you are using switch off and on: this is caused by a safety device that limits the temperature of the hob. This is quite normal, especially when cooking at high temperatures. If it happens a lot with a particular pan, however, it may mean the pan is not suitable – perhaps too small or too uneven – for a ceramic hob.

## Dual element hob plates

The areas marked with two concentric circles have an inner and an outer element. Rotate the control knob clockwise to heat the whole area for larger pans; turn it counter-clockwise to just heat the inner part for smaller pans (**Fig. 2.7**).

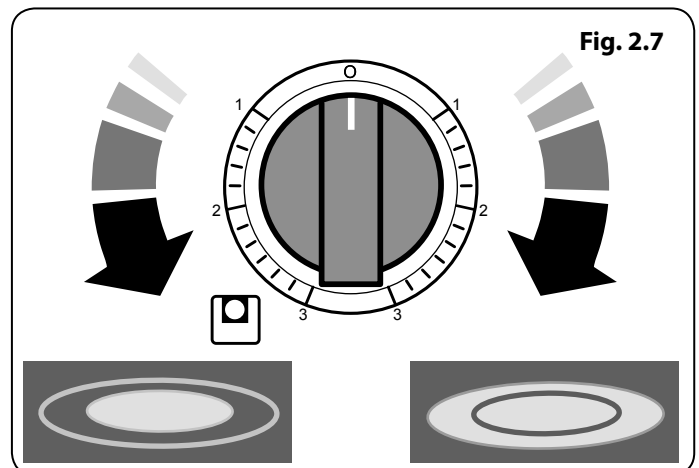
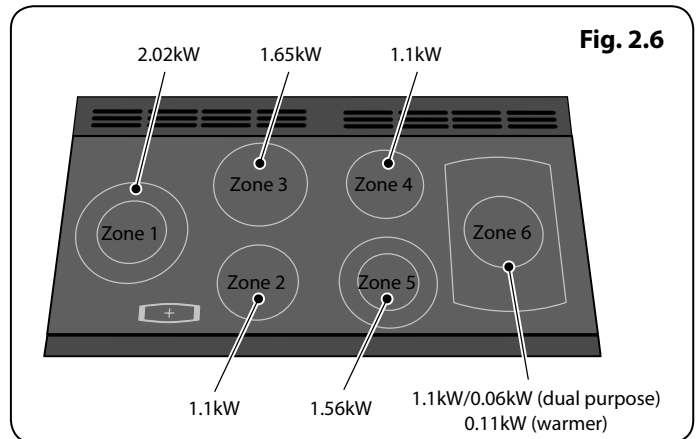
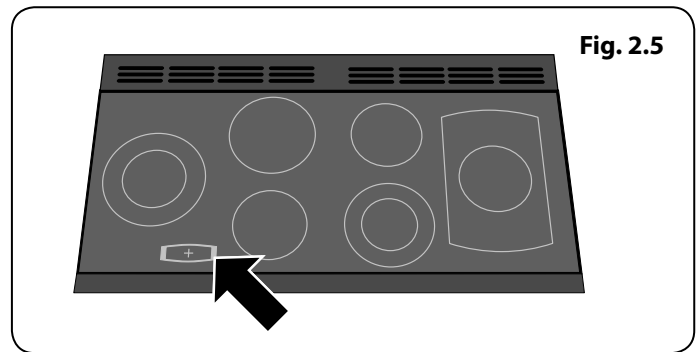

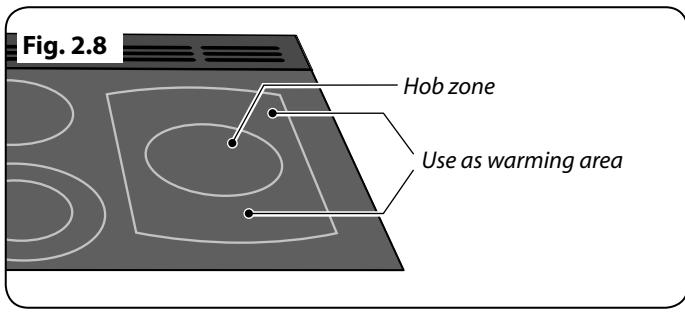

## Dual purpose hob/warmer area

On the right-hand side of the hob there is a dual purpose area. The inner ring marks out the 1.2 kW hob area (**Fig. 2.8**). The outer ring marks the extent of a warmer, which you can use for keeping food warm while the final touches are put to a meal. Refer to (**Fig. 2.9**) or (**Fig. 2.10**) for further details.

1. To use the warmer area, turn the control to the first (warmer) position to heat the whole area to a low temperature.
2. To use the dual purpose hob, turn it further to use the inner ring as a normal hob plate.

## Dual purpose hob/warmer area knob overview

Fig. 2.9

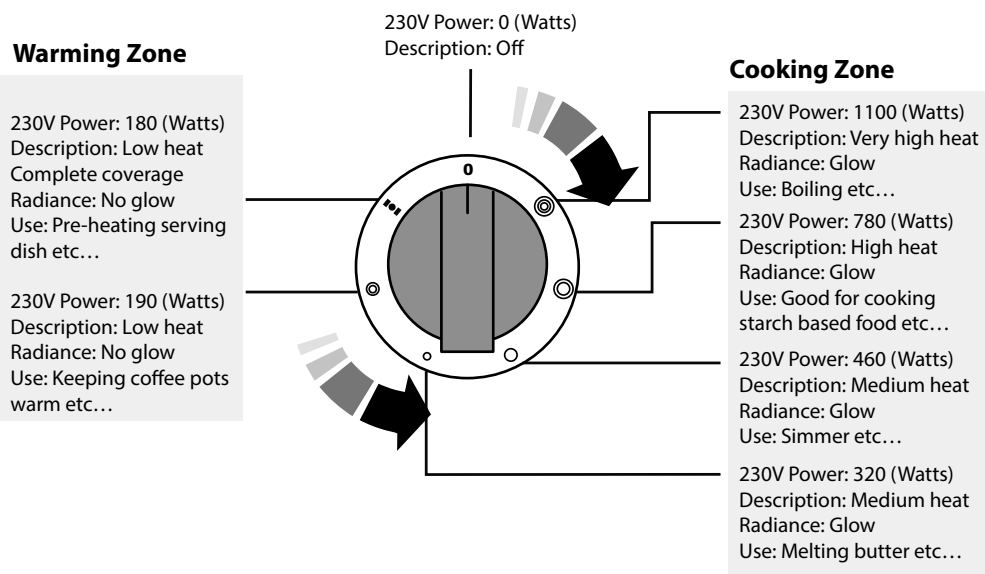
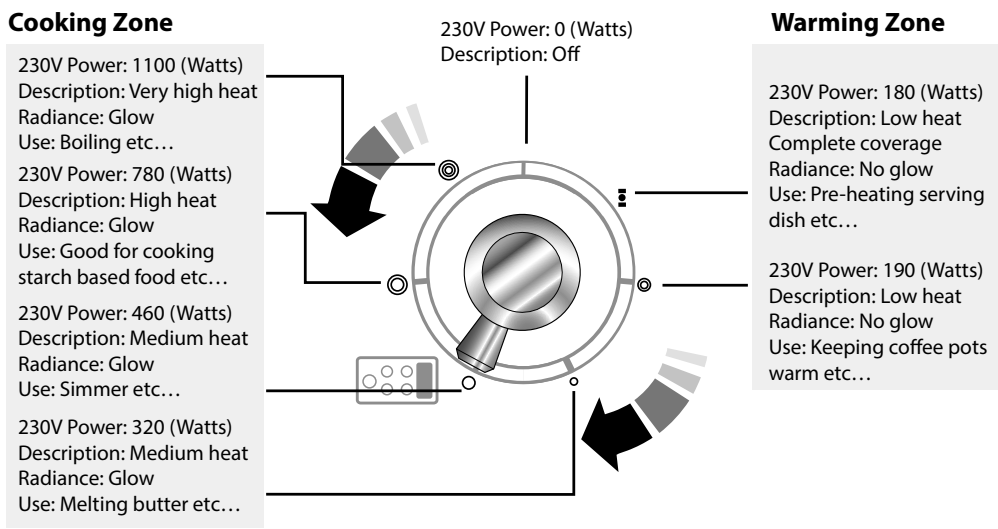

Fig. 2.10



## Grill / Glide-out Grill™

Open the door and pull the grill pan (Fig. 2.11) or carriage (Fig. 2.12 and Fig. 2.13) forward using the handle.

The grill has two elements that allow either the whole area of the pan to be heated or just the right-hand half.

Adjust the heat to suit by turning the control knob. To heat the whole grill, turn the knob clockwise (Fig. 2.14).

To heat the right-hand half, turn the control knob counter-clockwise. The neon indicator light by the grill control will come on.

For best results, leave the grill pan in the grill chamber and preheat the appropriate part(s) of the grill for two minutes. The grill trivet can be removed and the food placed on it while you are waiting for the grill to preheat.

**⚠ DO NOT leave the grill on for more than a few moments, without the grill pan underneath it, otherwise the knobs may become hot.**

Once the grill has preheated, take the grill pan out again and put the trivet back in place with the food on it. Slide the grill pan or carriage back into the grill chamber. Make sure that it is pushed right in.

**⚠ Accessible parts may be hot when the grill is in use. Young children should be kept away.**

The grill pan trivet in Fig. 2.11, Fig. 2.12, can be turned over to give two grilling positions (Fig. 2.15).

The grill pan trivet in Fig. 2.13 can be turned to give four grilling positions (Fig. 2.16).

**⚠ NEVER close the grill door when the grill is on.**

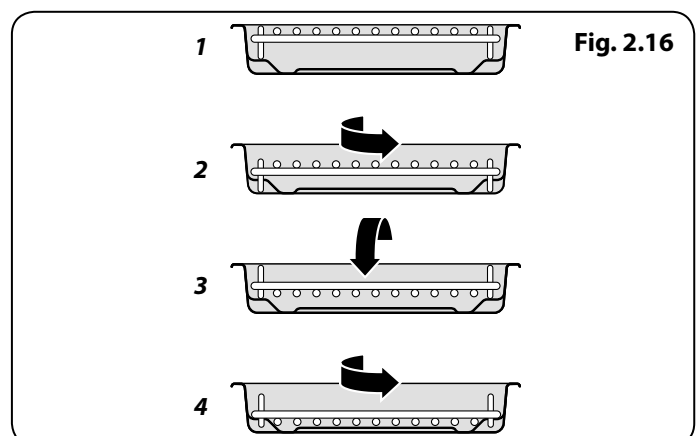
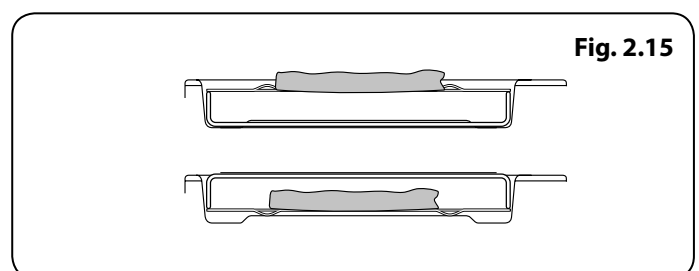
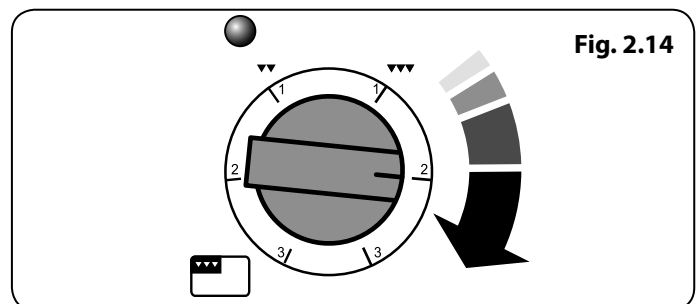
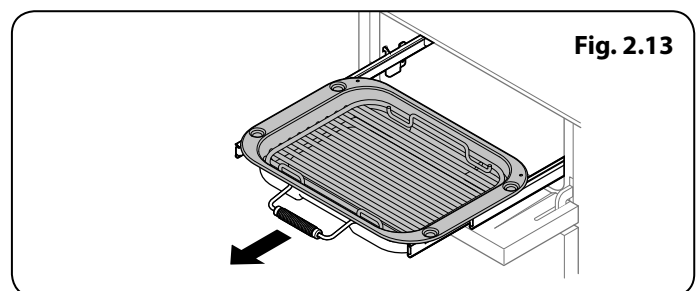
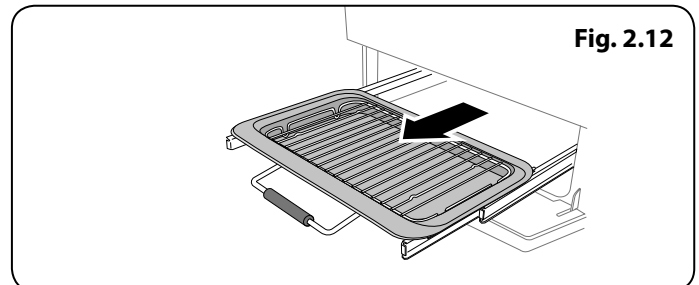
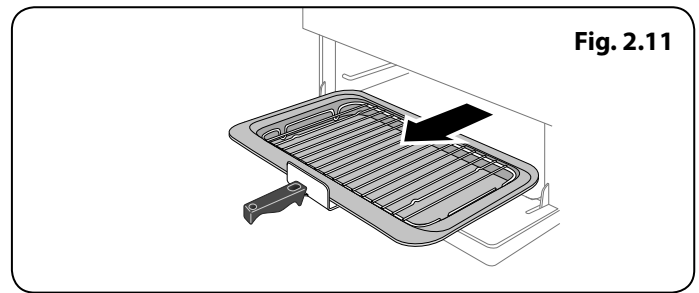

Fig. 2.17

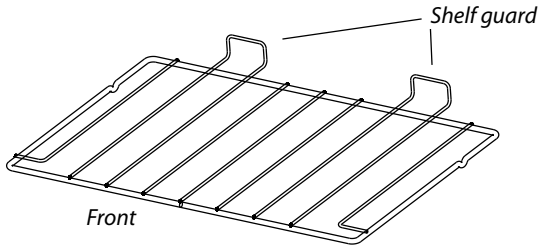

Fig. 2.18

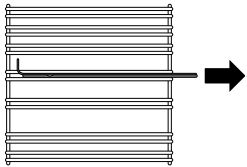

Fig. 2.19

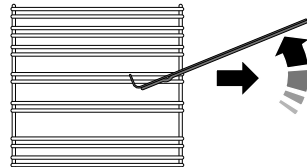

Fig. 2.20

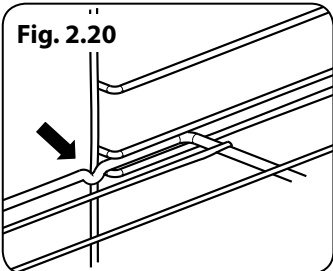

Fig. 2.21

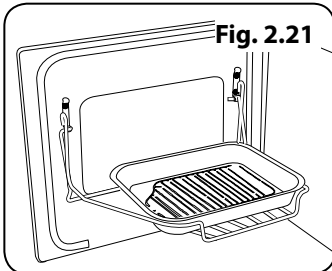

Fig. 2.22

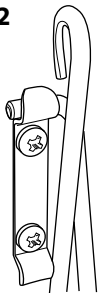

Fig. 2.23

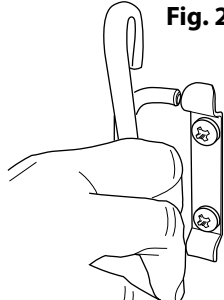

Fig. 2.24



## Accessories

### Oven shelves

The oven shelves (**Fig. 2.17**) are retained when pulled forward but can be easily removed and refitted.

Pull the shelf forward until the back of the shelf is stopped by the shelf stop bumps in the oven sides (**Fig. 2.18**).

Lift up the front of the shelf so the back of the shelf will pass under the shelf stop and then pull the shelf forward (**Fig. 2.19**).

To refit the shelf, line up the shelf with a groove in the oven side and push the shelf back until the ends hit the shelf stop. Lift up the front so the shelf ends clear the shelf stops, and then lower the front so that the shelf is level and push it fully back (**Fig. 2.20**).

### The handyrack (Main Oven)

The Handyrack (**Fig. 2.21**) fits to the left-hand oven door only. Food cooking on it is easy to attend to, because it is accessible when the door is open.

The maximum weight that can be held by the Handyrack is 5.5 kg (12 lb). It should only be used with the supplied roasting tin, which is designed to fit the Handyrack. Any other vessel could be unstable.

It can be fitted at two different heights. One of the oven shelves must be removed and the other positioned to suit.

When the Handyrack is used in its highest position, other dishes can be cooked on the bottom shelf position or base of the oven.

When the Handyrack is used in its lowest position, other dishes can be cooked on the second shelf position or base of the oven.

To fit the Handyrack, locate one side of it on the door bracket (**Fig. 2.22**). Then spring the other side out to clip it onto the other bracket (**Fig. 2.23**).

### Main oven light

Press the button to turn the light on (**Fig. 2.24**).

If the oven light fails, turn off the power supply before changing the bulb. See the 'Troubleshooting' section for details on how to change the bulb.

### Storage

The bottom drawer is for storing oven trays and other cooking utensils.

It can get very warm, so **DO NOT** store anything in it that may melt or catch fire. **NEVER** store flammable materials in the drawer. This includes paper, plastic and cloth items, such as cookbooks, plastic ware and towels, as well as flammable liquids. **DO NOT** store explosives, such as aerosol cans, on or near the appliance.

**⚠ Flammable materials may explode and result in fire or property damage.**

The drawer can be removed completely for cleaning, etc.

### 3. The ovens

The clock must be set to the time of day before the ovens will work. Read the clock section to set the time.

References to 'left-hand' and 'right-hand' ovens apply as viewed from the front of the appliance.

The left-hand oven is either:

- a conventional zoned oven
- a fan oven or
- a multi-function oven depending on model.

The right-hand oven is a fan oven.

#### Conventional zoned ovens

A conventional oven has two heating elements – one visible in the top of the oven and the other under the oven base.

**NOTE:** Be careful to avoid touching the top element and element deflector when placing or removing items from the oven.

#### Fan ovens

Fan ovens circulate hot air continuously, which means faster, more even cooking. The recommended cooking temperatures for a fan oven are generally lower than those for a non-fan oven.

#### Multifunction ovens

Multi-function ovens have an oven fan and oven fan element, as well as two extra heating elements. One element is in the top of the oven and the second is under the oven base. Take care to avoid touching the top element and element deflector when placing or removing items from the oven.

The multi-function oven has 3 main cooking functions, **fan**, **fan assisted** and **conventional cooking**. These functions should be used to complete most of your cooking.

The **browning element** and **base heat** can be used in the latter part of the cooking process to fine tune the results to your particular requirements.

Use **fanned grilling** for all your grilling needs and **defrost** to safely thaw small items of frozen food.

**Table 3.1** gives a summary of the multi-function modes.

The multi-function oven has many varied uses. We suggest you keep a careful eye on your cooking until you are familiar with each function. Remember, not all functions will be suitable for all food types.

Function	Use
<b>Defrost</b>	To thaw small items in the oven without heat
<b>Fan oven</b>	A full cooking function, even heat throughout, great for baking
<b>Fanned grilling</b>	Grilling meat and fish with the door closed
<b>Fan assisted</b>	A full cooking function good for roasting and baking
<b>Conventional oven</b>	A full cooking function for roasting and baking in the lower half of the oven
<b>Browning element</b>	To brown and crisp cheese topped dishes
<b>Base heat</b>	To crisp up the bases of quiche, pizza or pastry

**Table 3.1**

## Multifunction oven functions

### Rapid response *(Classic Deluxe only)*



The Rapid Response setting enables you to preheat the oven faster than normal. It uses the fan oven element with additional heat from one of the elements in the top of the oven. Fan ovens heat up quickly; but the Rapid Response feature speeds this process up enabling you to start cooking sooner.

To use the Rapid Response feature, turn the function control knob to **R** and set the temperature required. The light on the control panel next to the function control will come on.

When the required temperature is reached the top element will switch off and the light will go out.

The oven temperature is then maintained by the fan oven element and fan.

Should you choose to place food into the cold oven prior to cooking while using the Rapid Response function, make sure that cakes, etc. are not positioned too near the top of the oven.

### Fan oven



This function operates the fan and the heating element around it. An even heat is produced throughout the oven, allowing you to cook large amounts quickly.

Fan oven cooking is particularly suitable for baking on several shelves at one time and is a good 'all-round' function. It may be necessary to reduce the temperature by approximately 10°C for recipes previously cooked in a conventional oven.

If you wish to preheat the oven, wait until the indicator light has gone out before inserting the food.

### Fanned grilling



This function operates the fan whilst the top element is on. It produces a more even, less fierce heat than a conventional grill. For best results, place the food to be grilled, on a grid over a roasting tin, which should be smaller than a conventional grill pan. This allows greater air circulation. Thick pieces of meat or fish are ideal for grilling in this way, as the circulated air reduces the fierceness of the heat from the grill.

The oven door should be kept closed while grilling is in progress, so saving energy.

You will also find that the food needs to be watched and turned less than for normal grilling. Preheat this function before cooking.

For best results we recommend that the grill pan is not located on the uppermost shelf.

### Fan assisted oven



This function operates the fan, circulating air heated by the elements at the top and the base of the oven. The combination of fan and conventional cooking (top and base heat) makes this function ideal for cooking

large items that need thorough cooking, such as a large meat roast.

It is also possible to bake on two shelves at one time, although they will need to be swapped over during the cooking time, as the heat at the top of the oven is greater than at the base, when using this function.

This is a fast intensive form of cooking; keep an eye on the food cooking until you have become accustomed to this function.

### Conventional oven *(Top and Base Heat)*



This function combines the heat from the top and base elements. It is particularly suitable for roasting and baking pastry, cakes and biscuits.

Food cooked on the top shelf will brown and crisp faster than on the lower shelf, because the heat is greater at the top of the oven than at the base, as in 'Fan Assisted Oven' function. Similar items being cooked will need to be swapped around for even cooking. This means that foods requiring different temperatures can be cooked together, using the cooler zone in the lower half of the oven and hotter area to the top.

The exposed top element may cook some foods too quickly, so we recommend that the food be positioned in the lower half of the oven to cook. The oven temperature may also need to be lowered.

### Browning element



This function uses the element in the top of the oven only. It is a useful function for the browning or finishing of pasta dishes, vegetables in sauce, shepherds pie and lasagne, the item to be browned being already hot before switching to the top element.

### Base heat



This function uses the base element only. It will crisp up your pizza or quiche base or finish off cooking the base of a pastry case on a lower shelf. It is also a gentle heat, good for slow cooking of casseroles in the middle of the oven or for plate warming.

The Browning and Base Heat functions are useful additions to your oven, giving you flexibility to finish off items to perfection.

### Defrost



This function operates the fan to circulate cold air only. Make sure the temperature control is at 0°C and that no heat is applied. This enables small items such as desserts, cream cakes and pieces of meat, fish and poultry to be defrosted.

Defrosting in this way speeds up the process and protects the food from flies. Pieces of meat, fish and poultry should be placed on a shelf, over a tray to catch any drips. Be sure to wash the shelf and tray after defrosting.

Defrost with the oven door closed.

Large items, such as whole chickens and joints should not be defrosted in this way. We recommend this be carried out in a refrigerator.



Defrosting should not be carried out in a warm oven or when an adjoining oven is in use or still warm.

Make sure that dairy foods, meat and poultry are completely defrosted before cooking.

## Operating the ovens

### Conventional zoned ovens and fan ovens

Turn the oven knob to the desired temperature (**Fig. 3.1**).

The oven indicator light will glow until the oven has reached the temperature selected. It will then cycle on and off during cooking.

### Multifunction ovens

The multi-function oven has two controls: a function selector and a temperature setting knob (**Fig. 3.2**).

Turn the function selector control to a cooking function. Turn the oven temperature knob to the temperature required (**Fig. 3.1**).

The oven heating light will glow until the oven has reached the temperature you selected. It will then cycle on and off during cooking.

### The browning element *(conventional ovens)*

The browning element is positioned in the top of the left-hand oven. It can be used at the end of a normal cooking period to give extra browning to au gratin dishes or give a crisper finish to meat.

After the normal cooking is finished turn the left-hand oven thermostat knob clockwise to the browning position, indicated by (●●●●) on the fascia panel.

Only the browning element will operate when the thermostat is turned to this position. The top and base cooking elements will automatically switch off.

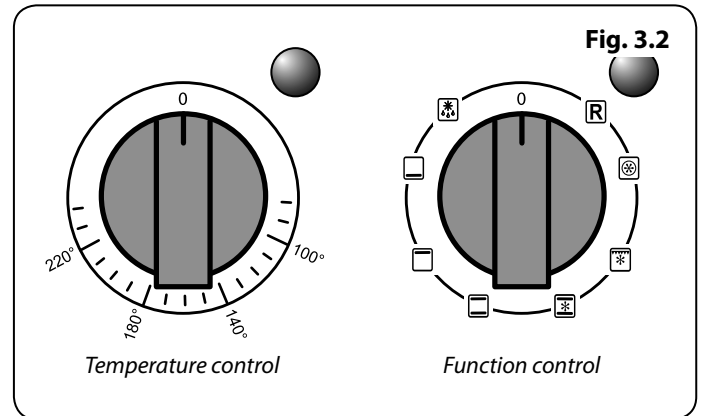
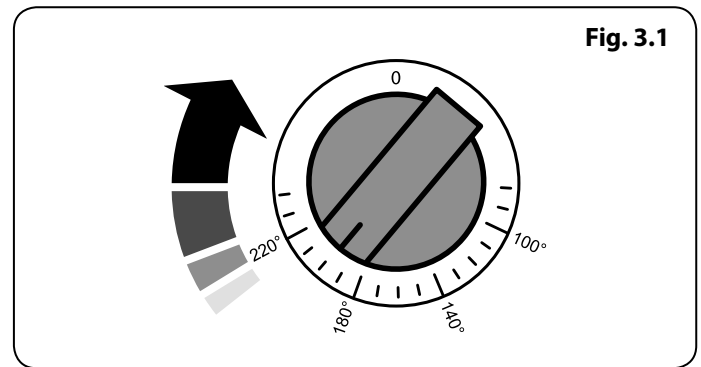

## 4. 2 Button - rotary clock

Fig. 4.1

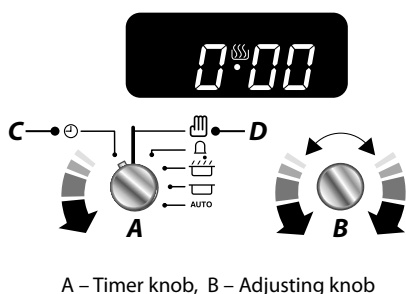

Fig. 4.2

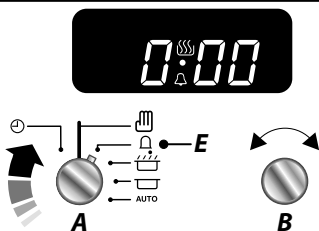

Fig. 4.3

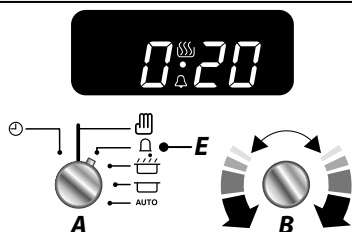
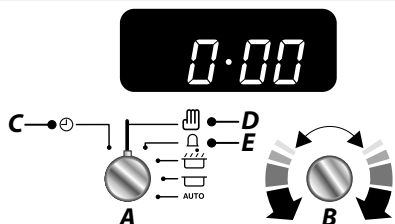

Fig. 4.4



The clock must be set to the time of day before the oven will work.

### Setting the Clock

1. Once the cooker is connected and switched on, the display will start to flash.
2. To set the time, turn the **Timer (A)** knob to the **Clock (C)** setting and back to the **Manual (D)** position. The centre dot will flash indicating the time can be set. Turn the **Adjusting (B)** knob either clockwise or counter-clockwise (**Fig. 4.1**) to set the time.
3. Once you have set the time, allow the centre dot to stop flashing, the time is now set.

### Setting the minute minder

A **Minute Minder (E)** is a feature that can be set for a number of minutes and sounds an alarm once the specified amount of time has elapsed.

1. Turn the **Timer (A)** knob to the **Minute Minder (E)** setting – it should click into position (**Fig. 4.2**).
2. Turn the **Adjusting (B)** knob to set the amount of time required. Minimum time 1 minute (**Fig. 4.3**).
3. Turn the **Timer (A)** knob back to the **Manual (D)** setting to see the current time and the 'Bell' symbol on the display.

### Cancel the timer alarm

Once the specified time has elapsed it will emit an alarm. There are two ways to cancel the alarm:

1. Turn the **Adjusting (B)** knob counter-clockwise or clockwise (**Fig. 4.4**).
2. Turn the **Timer (A)** knob to the **Clock (C)** or the **Minute Minder (E)** setting, and back to the **Manual (D)** mode, to return to normal cooking (**Fig. 4.4**).

#### NOTE

If the alarm is not manually switched off it will stop after approximately 2 minutes.

When the Minute Minder is active the clock will not dim between the hours of 10 pm and 6 am

## To stop the oven at a specific time of day

You have set the required temperature and function mode and you would like the oven to automatically stop.

### TOP TIP

Make a note of the current time so you do not forget.

1. Turn the **Timer (A)** knob to the **Stop Time (G)** setting. 'AUTO' will show in the display (**Fig. 4.5**).
2. Turn the **Adjusting (B)** knob to the amount of cooking time required. The display will show the current time plus the additional cooking time you have set (**Fig. 4.6**).
3. Turn the **Timer (A)** knob to the **Auto (H)** setting. The display will show the current time, the cooking symbol and the word 'AUTO' (**Fig. 4.7**).
4. Once the specified time has elapsed it will emit an alarm and the oven will stop working. The cook pot symbol on the display will disappear and the word 'AUTO' will flash (**Fig. 4.8**).
5. When you return, turn the **Timer (A)** knob to the **Manual (D)** setting to return to manual cooking (**Fig. 4.8**).

### TOP TIP

You can check how much time you have left, to the programmed stop time, by turning **Timer (A)** from **Auto (H)** to **Stop Time (G)** and back to **Auto (H)**.

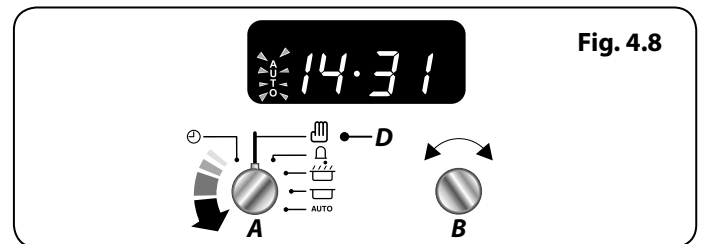
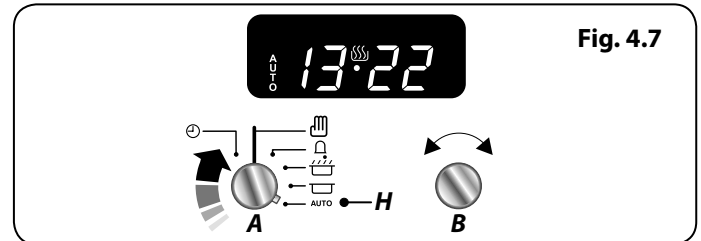
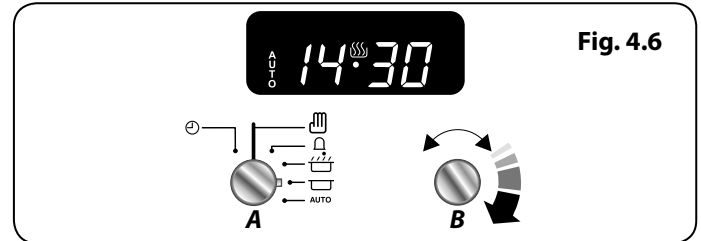
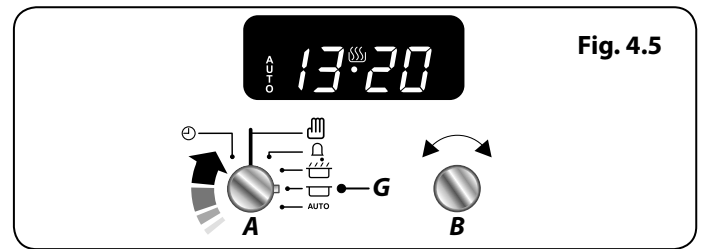

## To start and stop the oven automatically

The timer allows you to automatically start and stop by a combination of the length of the cooking time and the stop time. Giving you the flexibility to cook casseroles etc while you are out. You cannot set the actual start time.

1. Turn the **Timer (A)** knob to the **Cook Time (F)** setting. Turn the **Adjusting (B)** knob clockwise to set the length of the cooking time required (**Fig. 4.9**).
2. Turn the **Timer (A)** knob to the **Stop Time (G)** setting (**Fig. 4.10**). The display will show the current time of day plus the 'cook time' you just set.
3. Turn the **Adjusting (B)** knob to set the time of day you want the oven to stop cooking (**Fig. 4.11**).
4. Set the oven to the required cooking temperature and function mode.
5. Turn the **Timer (A)** knob to the **Auto (H)** setting (**Fig. 4.12**). If the display shows the current time and the word **'AUTO'** the oven is set to turn on and off.
6. When the program starts the oven, the cooking symbol will appear on the display. Once the specified time has elapsed it will emit an alarm and the Multifunction Oven will stop working. The 'Cooking' symbol on the display will disappear and the word **'AUTO'** will flash (**Fig. 4.13**).
7. Once the specified time has elapsed it will emit an alarm. There are two ways to cancel the alarm, refer to **"Cancel the timer alarm" on page 14**
  - The 'cook period', which is the length of time you want the oven to cook for.
  - The 'stop time', which is the time of day you want the oven to stop cooking.

## Reset to manual cooking

To cancel any automatic settings turn the **Timer (A)** knob to the **Manual (D)** setting and release (**Fig. 4.14**).

**NOTE:** Whilst this operation cancels all automatic program settings, it does not cancel the minute minder.

## Beeper tone adjustment

The beeper tone can be adjusted to three different levels.

Turn the **Timer (A)** knob to the **Clock (C)** setting. Turn the **Adjusting (B)** knob counter clockwise until the tone bars are displayed (**Fig. 4.15**).

To adjust the tone of the alarm, release the **Adjusting (B)** knob and then turn counter clockwise again (**Fig. 4.16**). The tone of the alarm will change. Repeat these steps until the desired alarm tone is set.

Fig. 4.9

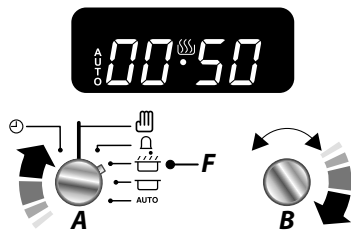

Fig. 4.10

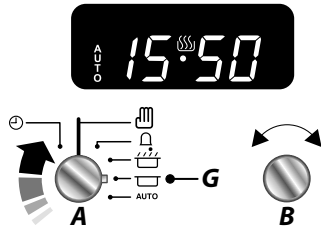

Fig. 4.11

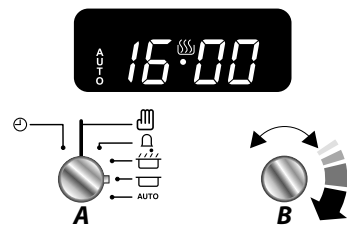

Fig. 4.12

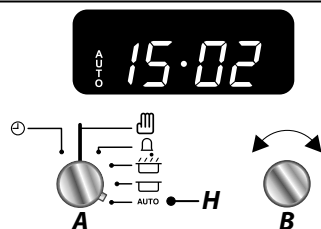

Fig. 4.13

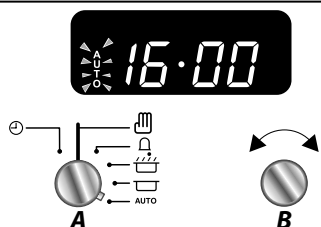

Fig. 4.14

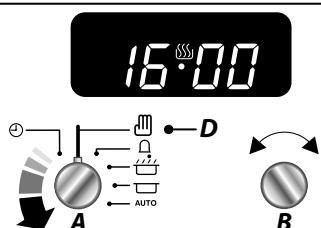

Fig. 4.15

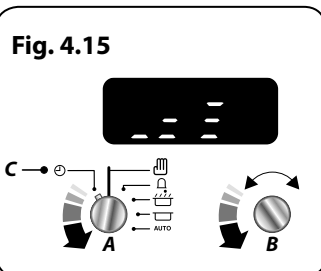
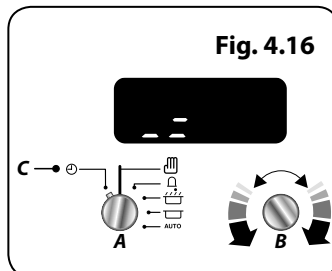

Fig. 4.16



## 5. 3 Button clock

### Using the clock

You can use the clock to turn the programmable oven on and off. **The clock must be set to the time of day before the oven will work.**

**NOTE:** When using the timer functions, first set the clock as required before setting the oven temperature.

The oven can be switched on when the cook symbol [🔥] is displayed.

### Setting the clock

1. The LCD clock is shown in **(Fig. 5.1)**. Once the cooker is connected and switched on, the display flashes (:00.00) and the time starts from (:00.00).
2. To set the clock press the [+] and [-] buttons simultaneously, the point between hours and minutes will start to flash for 5 seconds. Whilst the point is flashing press either the [+] or [-] button to set the correct time.

**IMPORTANT:** The timed oven will not operate unless the clock has been set.

### Program selection - Setting the minute minder

The minute minder [🔔] provides the ability to set a countdown from 00:01h to 23:59h, at the end of which an alarm will sound.

1. Press the mode [M] button once **(Fig. 5.2)**. The bell symbol [🔔] will flash on the display. Select the desired countdown from 00:01h to 23:59h using the [+] button **(Fig. 5.3)**. The countdown will automatically begin and the [🔔] symbol will show in the display.
2. Once the specified time has elapsed an alarm will sound.
3. To stop the alarm press any button.

### Re-set the minute minder

To re-set the minute minder, first select the minute minder program by pressing the mode [M] button. Then press the [+] and [-] buttons simultaneously.

- The 'cook period', which is the length of time you want the oven to cook for (dur).
- The 'stop time', which is the time of day you want the oven to stop cooking (End).

### To stop the programmable oven at a specific time of day

1. Press the mode [M] button 3 times, until the display flashes 'End' **(Fig. 5.4)**.
2. Select the 'stop time' using the [+] or [-] buttons. The display will show the current time along with the 'AUTO' and Cooking [🔥] symbols **(Fig. 5.5)**.

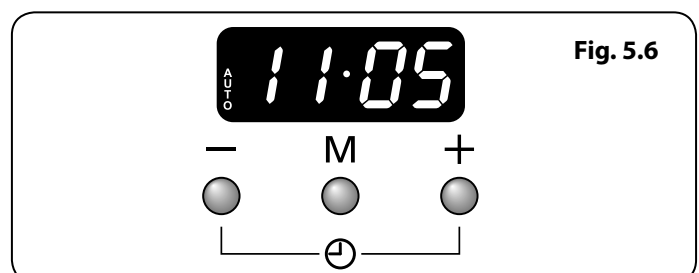
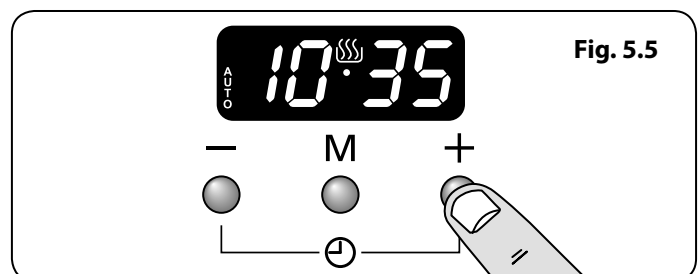
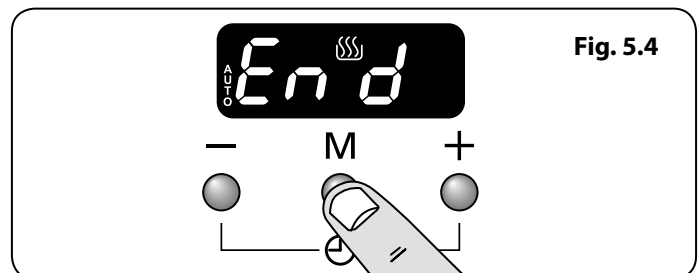
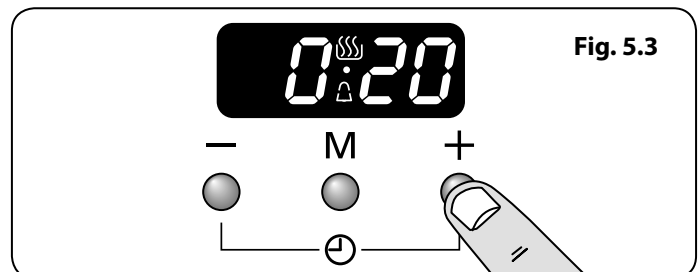
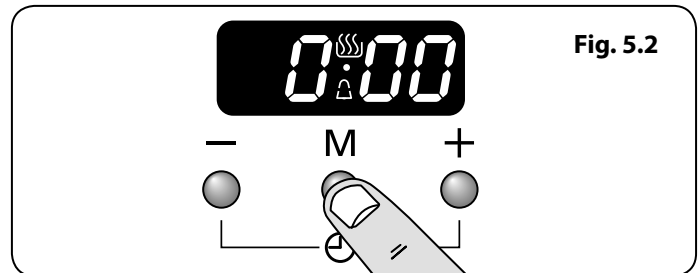
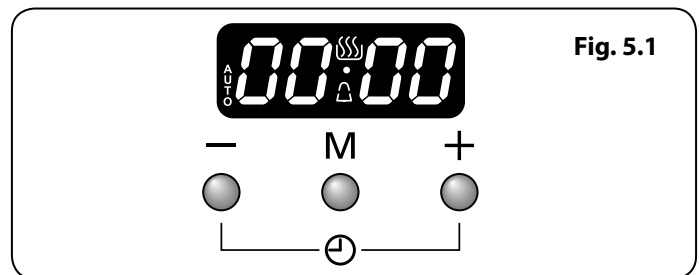

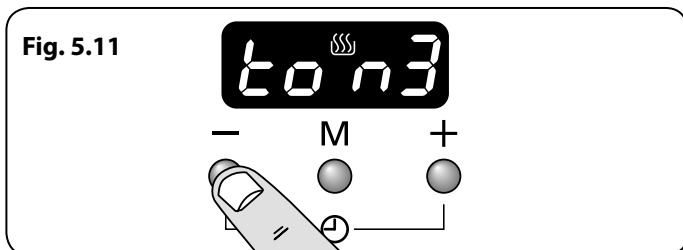
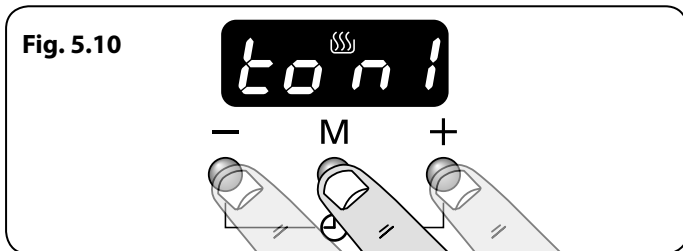
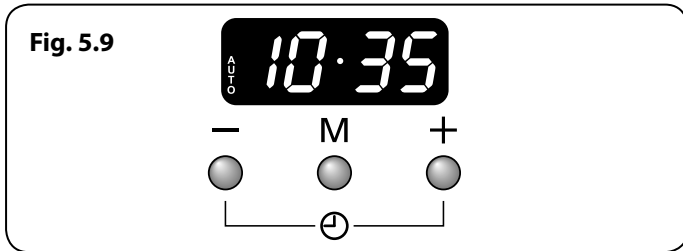
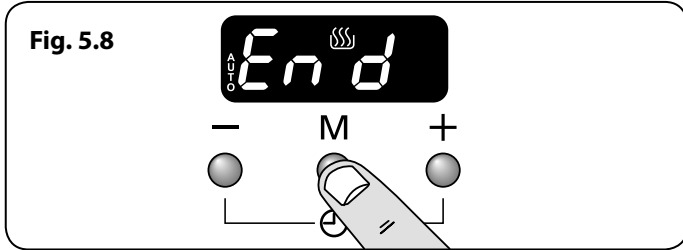
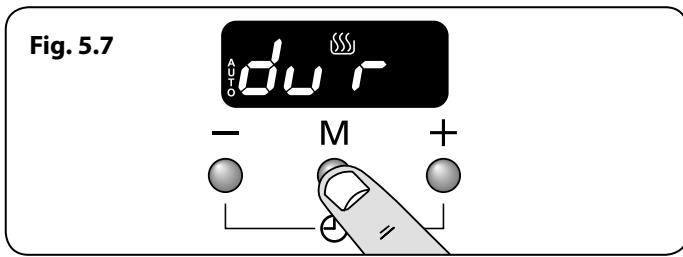

- When the 'stop time' is reached an alarm will sound and the oven will stop working. The word 'AUTO' will flash on the display (**Fig. 5.6**).
- Press any button to stop the alarm and return to manual cooking. If the alarm is not stopped, it will stop automatically after 7 minutes.

### To start and then stop the programmable oven

Set the programmable oven to automatically start and stop using a combination of the 'cook period' and 'stop time'.

You cannot set a start time directly – this is set automatically by a combination of the 'cook period' and 'stop time'.

- Press the mode [M] button until the display flashes 'dur' (**Fig. 5.7**). Then set the 'cook period' using the [+] or [-] buttons.
- Press the mode [M] button until the display flashes 'End' (**Fig. 5.8**). Then set the 'stop time' using the [+] or [-] buttons. Current time will be displayed along with the word 'AUTO' (**Fig. 5.9**).
- Set the oven to the required cooking temperature.
- During the 'cook period' the cook symbol [🔥] is illuminated in the display.
- When cooking is finished an alarm will sound. Press any button to stop the alarm and return to manual cooking. If the alarm is not stopped, it will stop automatically after 7 minutes.

### AUTO is showing, but you want to revert to manual cooking

You can cancel any automatic settings by pressing the [+] and [-] buttons simultaneously.

### Changing the frequency of the alarm

It is possible to change the alarm frequency.

- Press the the [+] and [-] buttons simultaneously, then the mode [M] button. The display will show 'ton1,2 or 3' (**Fig. 5.10**).
- To select the tone press the [-] button until desired tone is reached (**Fig. 5.11**).

## 6. 6 Button clock

### Using the clock

You can use the timer (**Fig. 6.1**) to turn the oven(s) on and off. **The clock must be set to the time of day before the oven(s) will work.**

**Table 6.1** describes the symbols shown on the digital display.

### Setting the time of day

When the cooker is first connected to the mains, or if there has been a prolonged power interruption, the clock display flashes [0:00] and [AUTO].

During the time setting process the centre dot will flash. When the process is complete the dot will stop flashing and the [🍳] symbol will be displayed.

The time of day can be set in two ways:

- Press and hold the [🕒] button. Now press the [+] or [-] buttons to increase or decrease the time (**Fig. 6.2**). Holding the [+] or [-] buttons for more than 2 seconds will advance / decrease the set time quickly. Release the buttons to set the time of day.
- Press and hold both the [🍳] and [🔧] buttons down (**Fig. 6.3**). Now press the [+] button (or [-] button) until the correct time shows.

### DO NOT forget that it is a 24-hour clock.

If you need to reset the clock/cooker, turn off the power and wait several minutes, then start again.

### Automatic dimming

Providing there are no automatic programs set, and the minute minder is not active, your clock will automatically dim during the hours between 22:00 and 06:00.

### Minute minder

Press and hold the [🕒] button (**Fig. 6.4**), and then press the [+] button (or [-] button) until the length of time you want to cook for is shown (**Fig. 6.5**).

You can check the time remaining by pressing [🕒]. When the beeper sounds cancel it by pressing any button.

To reset the minute minder time; simultaneously press the [+] and [-] buttons.

**NOTE:** This will clear all automatic programs.

- The 'cook period', which is the length of time you want the oven to cook for.
- The 'stop time', which is the time of day you want the oven to stop cooking.

### Setting a cook duration

Press and hold the [🍳] button and set the required 'cook period' by pressing the [+] button (or [-] button) (**Fig. 6.6**). The clock will now control the cook period of your oven(s). The [🍳] symbol and [AUTO] will be displayed.

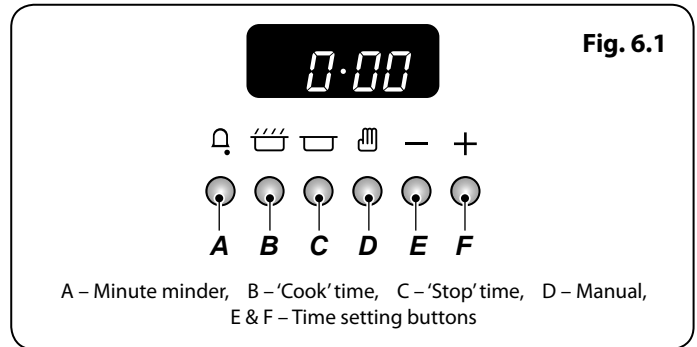

Symbol	Function	Notes
[🕒]	Minute Minder is active	
[🍳]	Oven(s) can be operated	If the 'cook' [🍳] symbol is not displayed the program has either: ended and the oven(s) are non-operational the oven(s) are being controlled by an automatic program that has not started
[AUTO]	Oven(s) are being controlled in semi-automatic or automatic mode	
[P]	Self clean (pyrolytic) mode has been enabled	Your cooker may not have this pyrolytic function
[dot]	Flashes during setting the time of day	

**Table 6.1**

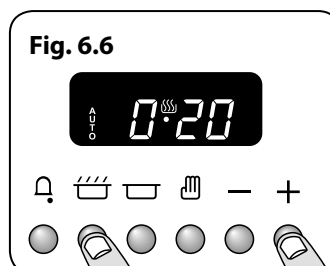
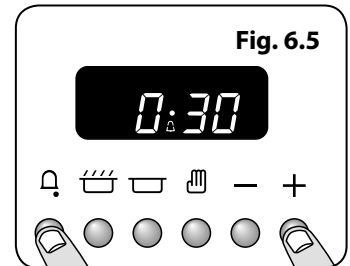
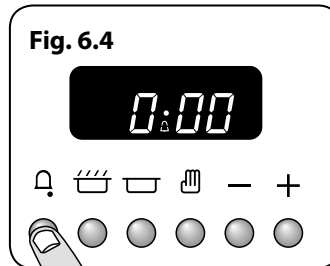
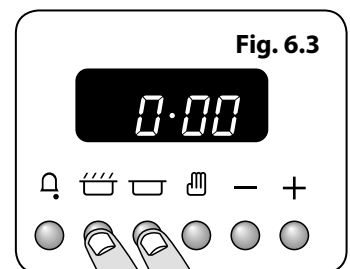
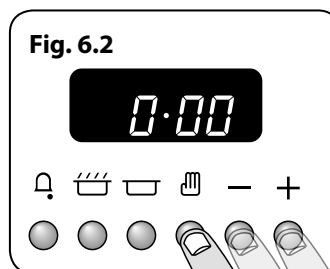

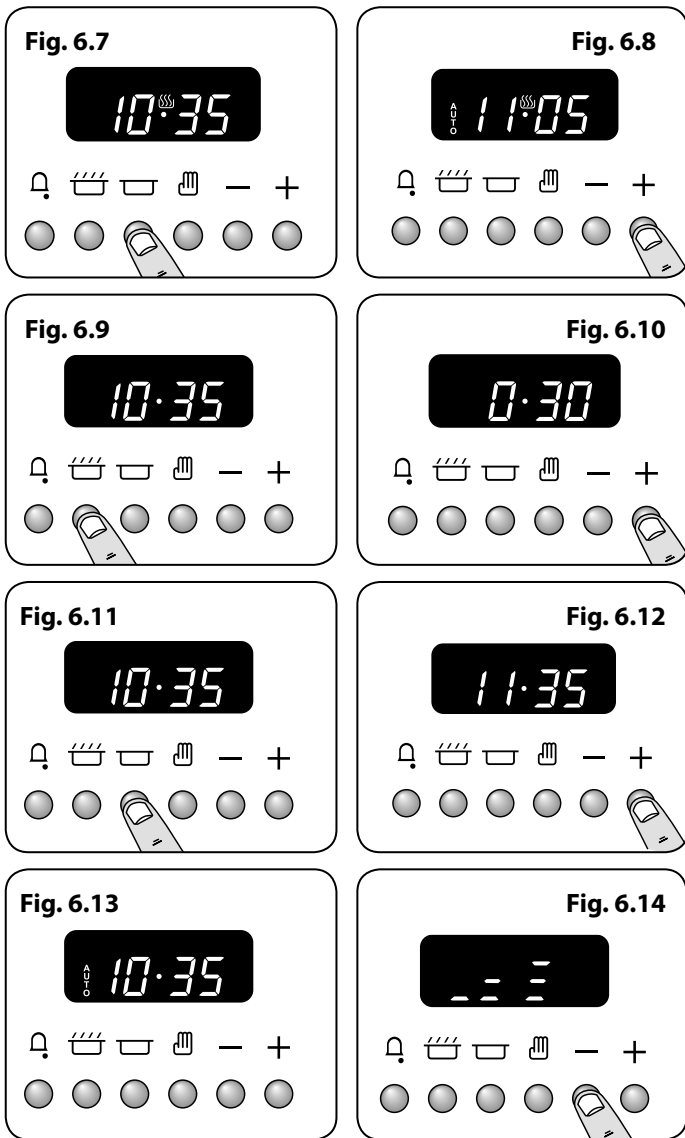

Symbol	Function	Notes
[🔔]	Sets the Minute Minder	Used with the [+] and [-] buttons
[🕒]	Sets the duration / cook period	Used with the [+] and [-] buttons
[🕒]	Sets the end / stop cook time	Used with the [+] and [-] buttons
[🕒] or [🕒]&[🕒]	Allows the time of day to be set when 'AUTO' is not active	Used with the [+] and [-] buttons
[🕒]	Resets the cooking control to manual	
[-]	Decreases time interval	Holding this button down allows a quick set
[+]	Increases time interval	Holding this button down allows a quick set
[+] & [-]	Clears all 'AUTO' and minute minder programs	

**Table 6.2**

Once the 'cook period' is reached, the beeper sounds and the [AUTO] symbol flashes. Turn the oven control knob to 0 and then press any button to stop the beep. Press [🕒] to return to manual cooking.

**Setting a cook end time**

Press and hold the 'stop time' [🕒] button (Fig. 6.7) and then press the [+] button (or [-] button) until the required 'stop time' shows (Fig. 6.8). The [🕒] symbol and [AUTO] will show in the display.

Once the 'stop time' is reached, the beeper sounds and the [AUTO] symbol flashes. Turn the oven control knob to 0 and then press any button to stop the beep. Press [🕒] to return to manual cooking.

**To start and stop the ovens automatically**

Before you set the clock for automatic operation you must have two numbers clearly in mind – the 'cook period' and the 'stop time'.

**NOTE:** You cannot set a start time directly – this is set automatically by setting the 'cook period' and the 'stop time'.

Press and hold the [🕒] button (Fig. 6.9) and then press the [+] button (or [-] button) until the required 'cook period' shows (Fig. 6.10).

Now press and hold the [🕒] button (Fig. 6.11) and then press the [+] button (or [-] button) until the required 'stop time' shows (Fig. 6.12). Release the buttons.

[AUTO] will now show in the display (Fig. 6.13).

Set the oven(s) to the required temperature. When cooking is finished [AUTO] will flash and the beeper will sound. Turn the oven knob(s) to the OFF position first, and then press any button once to stop the beep; press the [🕒] button to return to manual cooking.

If you are out, do not worry about the beeper going off, it stops after a while. When you return, turn the oven knob(s) to 0 first, and then press [🕒] to return to manual cooking.

**AUTO is showing, you want to reset to manual cooking**

To return to manual cooking mode from an Automatic setting, simultaneously press the [+] and [-] key, this will clear the automatic program and return to manual mode.

**NOTE:** This action will also clear the [Minute Minder] setting.

**Beeper tone adjustment.**

The beeper tone can be adjusted to three different levels.

Whilst in the time of day mode, press and hold the [-] button for a period until the display shows the Tone Bars (Fig. 6.14). Release the [-] button and immediately press again, this will adjust the tone down by a bar. Continue the process until a comfortable, tone is reached.

**NOTE:** During a power reset the clock will remember the last tone set.

For an overview of the functions refer to **Table 6.2**.



## 7. Cooking Tips

---

### Hints on Using Your Induction Cooker

If you have not used an induction cooker before please be aware of the following:

- Make sure that the pans you have or buy are suitable for use on the induction hob. Stainless steel, enamelled steel or cast iron is ideal. Double check before you buy pans – they must have bases that would attract a magnet.
- Allow time to get used to induction cooking; it is fast and powerful as well as being gentle. When simmering, you may notice that liquids appear to stop bubbling and then start again almost immediately. This is perfectly normal.
- You may notice a faint vibrating sound coming from the pans when using the induction hob. Again, this is perfectly normal and will depend upon the type and style of pans you are using.
- The induction heating elements will phase on and off when cooking. Although an active cooking zone may appear to switch on and off, a constant heat is still being supplied to the base of the pan – this is completely normal.

### Tips on Cooking with the Timer

If you want to cook more than one dish, choose dishes that require approximately the same cooking time. However, dishes can be 'slowed down' slightly by using small containers and covering them with aluminium foil, or 'speeded up' slightly by cooking smaller quantities or placing them in larger containers.

Very perishable foods such as pork or fish should be avoided if a long delay period is planned, especially in hot weather.

 **DO NOT place warm food in the oven to be timed.**

 **DO NOT use a timed oven that is already warm.**

 **DO NOT use the timed oven if the adjoining oven is already warm.**

Whole poultry must be thoroughly defrosted before being placed in the oven. Check that meat and poultry are fully cooked before serving.

### General Oven Tips

The wire shelves should always be pushed firmly to the back of the oven.

Baking trays with food cooking on them should be placed level with the front edge of the oven's wire shelves. Other containers should be placed centrally. Keep all trays and containers away from the back of the oven, as overbrowning of the food may occur.

For even browning, the maximum recommended size of a baking tray are:

- depth: 340 mm (13 3/8") by width: 340 mm (13 3/8") in the main oven

**When the oven is on, DO NOT leave the door open for longer than necessary, otherwise the knobs may get very hot.**

- Always leave a "finger's width" between dishes on the same shelf. This allows the heat to circulate freely around them.
- To reduce fat splashing when you add vegetables to hot fat around a roast, dry them thoroughly or brush lightly with cooking oil.
- Where dishes may boil and spill over during cooking, place them on a baking tray.
- The 'Cook & Clean' oven liners (see 'Cleaning Your Cooker') work better when fat splashes are avoided. Cover meat when cooking.
- Sufficient heat rises out of the oven while cooking to warm plates in the grill compartment.
- If you want to brown the base of a pastry dish, preheat the baking tray for 15 minutes before placing the dish in the centre of the tray.

## 8. Cooking Table

The oven control settings and cooking times given in the table below are intended to be used as a **guide only**. Individual tastes may require the temperature to be altered to provide a preferred result.

Food is cooked at lower temperature in a fan oven than in a conventional oven. When using recipes, reduce the fan oven temperature by 10°C and the cooking time by 5-10 minutes. The temperature in the fan oven does not vary with height in the oven so you can use any shelf.

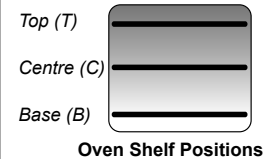

Food	Conventional Oven	Fan Oven	Approximate Cooking Time	
	Temperature °C (Shelf Position)	Temperature °C		
<b>Meat</b>				
Beef (no bone)	160 (C)	150	30-35 minutes per 500g +30-35 minutes.	<i>Thoroughly thaw frozen joints before cooking. Meat may be roasted at 220°C (210°C for fan oven) and the cooking time adjusted accordingly. For stuffed and rolled meats, add approximately 10 minutes per 500g, or cook at 200°C (190°C) for 20 minutes then 160°C (150°C) for the remainder.</i>
	200 (C)	190	20-25 minutes per 500g +20-25 minutes.	
Lamb	160 (C)	150	30-35 minutes per 500g +30-35 minutes.	
	200 (C)	190	25-30 minutes per 500g +25-30 minutes.	
Pork	160 (C)	150	35-40 minutes per 500g +35-40 minutes.	
	200 (C)	190	25-30 minutes per 500g +25-30 minutes.	
<b>Poultry</b>				
Chicken	160 (C)	150	20-25 minutes per 500g +20-25 minutes.	<i>For stuffed poultry, you could cook at 200°C (190°C) for 20 minutes then 160°C (150°C) for remainder. Do not forget to include the weight of the stuffing. For fresh or frozen prepacked poultry, follow instructions on the pack. Thoroughly thaw frozen poultry before cooking.</i>
	200 (C)	190	15-20 minutes per 500g +15-20 minutes.	
Turkey	160 (C)	150	20 minutes per 500g +20 minutes.	
	200 (C)	190	15 minutes per 500g +15 minutes.	
Duck	160 (C)	150	25-30 minutes per 500g.	
	200 (C)	190	20 minutes per 500g.	
<b>Casserole</b>	140-150 (C)	130-140	2-4 hours according to recipe.	
<b>Yorkshire Pudding</b>	220 (C)	210	Large tins 30-35 minutes; individual 10-20 minutes.	
<b>Cake</b>				
Very rich fruit - Christmas, wedding, etc.	140 (C/B)	130	45-50 minutes per 500g of mixture.	<i>Using the conventional oven: when two tier cooking leave at least one runner space between shelves. Position the baking tray with the front edge along the front of the oven shelf.</i>
Fruit 180 mm tin	150 (C/B)	140	2-2½ hours.	
Fruit 230 mm tin	150 (C/B)	140	Up to 3½ hours.	
Madeira 180 mm	160 (C/B)	150	80-90 minutes.	
Queen cakes	190 (C/B)	180	15-25 minutes.	
Scones	220 (C/B)	210	10-15 minutes.	
Victoria sandwich				<i>Up to three tiers can be cooked in a fan oven at the same time but make sure to leave at least one runner space between each shelf being cooked on.</i>
180 mm tin	180 (C/B)	170	20-30 minutes.	
210 mm tin	180 (C/B)	170	30-40 minutes.	
<b>Desserts</b>				
Shortcrust tarts	200 (C/B)	190	20-30 minutes on a preheated tray.	<i>Using the conventional oven: for even browning the maximum size of baking tray recommended is 340 mm x 340 mm. This ensures free heat circulation.</i>
Fruit pies	200 (C/B)	190	35-45 minutes.	
Tartlets	200 (C/B)	190	10-20 minutes according to size.	
Puff pastry	210 (C/B)	200	20-40 minutes according to size.	<i>If cooking a two tier load, the trays should be interchanged approximately halfway through the cooking time.</i>
Meringues	100 (C/B)	90	2-3 hours.	
Baked egg custard	160 (C/B)	150	45-60 minutes.	
Baked sponge pudding	180 (C/B)	170	40-45 minutes.	
Milk pudding	140-150 (C/B)	130-140	2 to 3 hours.	
<b>Bread</b>	210 (C)	200	20-30 minutes.	
<b>Fish</b>				
Fanned Grilling				
Fillet	190 (C/B)	190 (C/B)	15-20 minutes.	
Whole	190 (C/B)	190 (C/B)	15-20 minutes per 500g.	
Steak	190 (C/B)	190 (C/B)	Steaks according to thickness.	

## 9. Cleaning your cooker

- ⚠ **Isolate the electricity supply before carrying out any major cleaning. Then allow the cooker to cool.**
- ⚠ **NEVER use paint solvents, washing soda, caustic cleaners, biological powders, bleach, chlorine based bleach cleaners, coarse abrasives or salt.**
- ⚠ **DO NOT mix different cleaning products – they may react together with hazardous results.**

All parts of the cooker can be cleaned with hot soapy water – **but take care that no surplus water seeps into the appliance.**

Remember to switch the electricity supply back on and reset the clock before re-using the cooker.

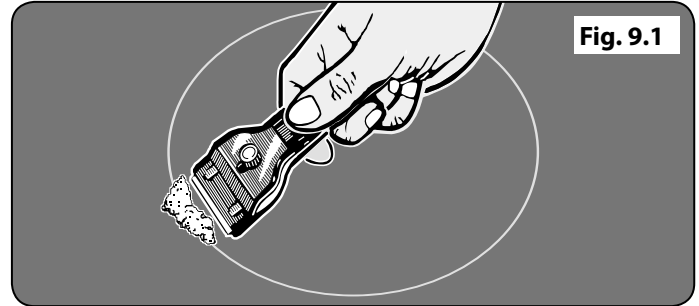

### Hob

#### Daily care

First of all, be sure that all heat indicator lights are off and that the cooking surface is cool. Apply a small dab of ceramic cleaning cream in the centre of each area to be cleaned. Dampen a clean paper towel and work the cream onto the cooking surface. As a final step, wipe the cooking surface with a clean, dry paper towel.

#### Cleaning spills

For spills and boil-overs that occur while cooking, turn off the unit and wipe the area surrounding the hot zone with a clean paper towel. If a spill (other than a sugary substance) is on the hot zone, do not clean until the unit has completely cooled down, and then follow the instructions below, 'Cleaning Burned-on Spills'.

If you accidentally melt anything on the surface, or if you spill foods with a high sugar content (preserves, tomato sauce, fruit juice, etc.), remove the spill **IMMEDIATELY** with a razor scraper, while the unit is still hot.

- ⚠ **IMPORTANT: Use an oven glove to protect your hand from potential burns.**

Scrape the major spill or melted material from the cooking zone and push into a cold area. Then, turn the unit 'OFF' and allow to cool before cleaning further. After the cooking surface cools down and the heat indicator lights go off, follow the 'Daily Care' procedure outlined above.

#### Cleaning burned-on spills

Make sure that the heat indicator lights are off and that the hob is cool. Remove the excess burned-on substance with a single-edged razor scraper. Hold the scraper at an angle of about 30° to the surface and then scrape off the burned-on matter (**Fig. 9.1**).

Once you have removed as much as possible with the scraper, follow the 'Daily Care' procedure outlined above.

Fig. 9.2

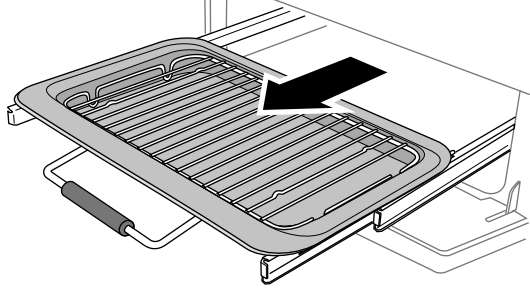

Fig. 9.3

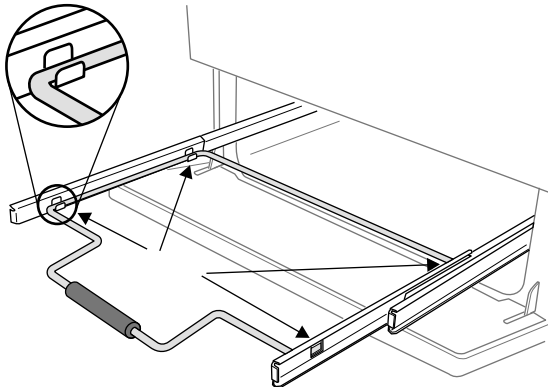

Fig. 9.4

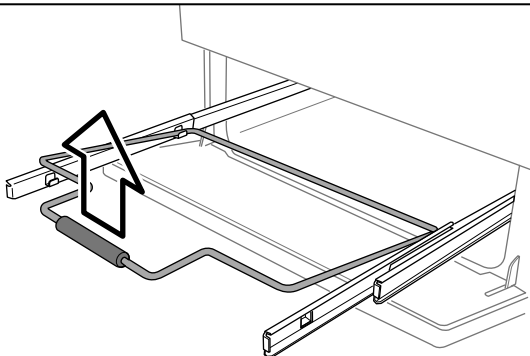

Fig. 9.5

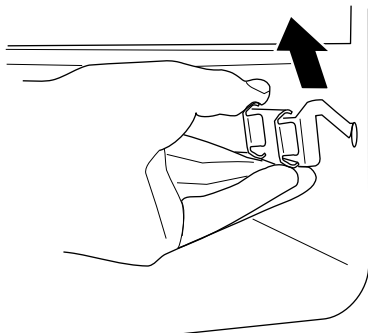
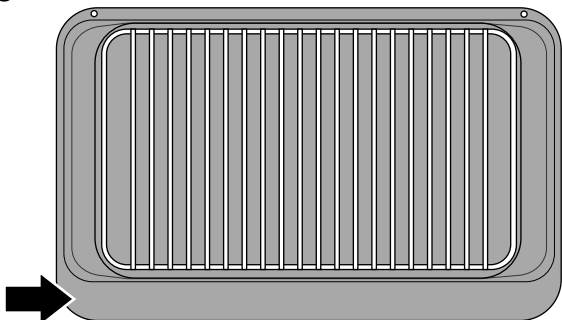

Fig. 9.6



## Grills

The grill pan and trivet should be washed in hot soapy water. After grilling meats or any foods that soil, leave to soak for a few minutes immediately after use. Stubborn particles may be removed from the trivet using a nylon brush. Alternatively, the grill pan can be washed in a dishwasher.

- ⚠ **Before you remove any of the grill parts for cleaning, make sure that they are cool, or use oven gloves.**
- ⚠ **DO NOT use any abrasive substances.**

## Removing the glide-out grill pan

The glide-out grill pan can be easily removed for cleaning as follows: Remove the grill pan support frame by pulling the grill pan forward (**Fig. 9.2**).

Lift the grill pan clear of the support frame. The support frame is held to the side rails by two clips on each side (**Fig. 9.3**).

For each side, support the side rail with one hand and with the other hand lift the frame up and out of the side clips (**Fig. 9.4**).

For safety, push the side rails back into the grill chamber.

If you need to remove the side rails to allow cleaning of the grill chamber, you can unhook them from the grill chamber sides (**Fig. 9.5**) and wipe the sides clean with a soft cloth and mild detergent.

- ⚠ **DO NOT put the side runners in a dishwasher.**

Once you have finished, hook the side rails back onto the sides of the chamber. To refit the frame, pull the side rails forward and, for each side in turn, support the side rail and press the frame down into the side rails. Replace the grill pan.

When refitting the grill pan, make sure that the wide rim is at the front (**Fig. 9.6**).

## Control panel and doors

Avoid using any abrasive cleaners, including cream cleaners. For best results, use a liquid detergent.

The same cleaner can also be used on the doors. Alternatively, use a soft cloth wrung out in clean hot soapy water. You can use the same method for cleaning the control panel and knobs. After cleaning, polish with a dry cloth.

## Glass fronted door panels

The oven door front panels can be taken off so that the glass panels can be cleaned. Move the cooker forward to gain access to the sides (see the 'Moving the Cooker' section under 'Installation').

Open the oven door slightly and remove the front panel fixing screws from the door sides, two each side (**Fig. 9.7**).

Carefully lift off the outer door panel. The inside face of the glass panels can now be cleaned – take care not to disturb or wet the door insulation.

**NOTE:** If the door is triple glazed then the inner two panels are fixed together and should not be separated. After cleaning, carefully refit the outer door panel and replace the side fixing screws.

**⚠ DO NOT use harsh abrasive cleaners or sharp metal scrapers to clean the oven door glass since they can scratch the surface, which may result in shattering of the glass.**

## Ovens

The oven door front panels can be taken off so that the glass panels can be cleaned. Move the cooker forward to gain access to the sides (see the 'Moving the Cooker' section under 'Installation').

### 'Cook & Clean' Panels

The ovens have side 'Cook & Clean' panels which have been coated with a special enamel that partly cleans itself. This does not stop all marks on the lining, but helps to reduce the amount of manual cleaning needed.

These panels work better above 200°C. If you do most of your cooking below this temperature, occasionally remove the panels and wipe with a lint free cloth and hot soapy water. The panels should then be dried and replaced and the oven heated at 200°C for about one hour. This will make sure that the panels are working effectively.

### Removing the panels to clean the enamel interior

Some of the lining panels can be removed for cleaning.

If you wish to clean the enamel interior of the oven, you will need to remove the shelves before removing the 'Cook & Clean' panels. To remove the side panels, simply lift the panel and slide forwards. (**Fig. 9.8**).

Once the panels have been removed, the oven enamel interior can be cleaned.

**⚠ DO NOT use steel wool, oven cleaning pads, or any other materials that will scratch the surface.**

Refit in the reverse order.

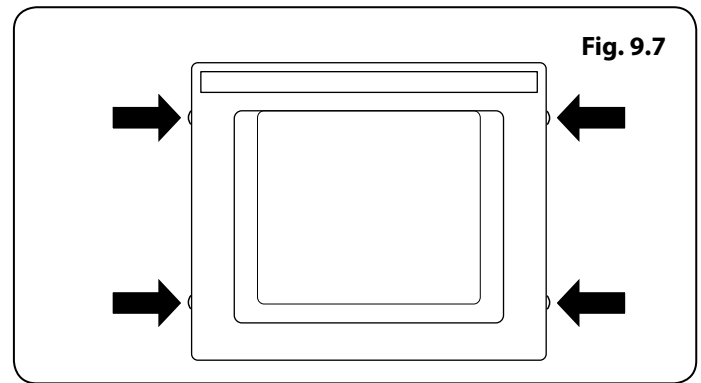

Fig. 9.7

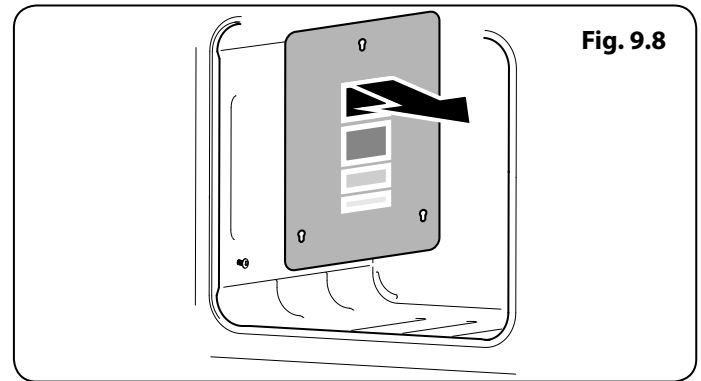

Fig. 9.8

## Cleaning table

Cleaners listed (**Table 9.1**) are available from supermarkets or electrical retailers as stated.

For enamelled surfaces use a cleaner that is approved for use on vitreous enamel.

Regular cleaning is recommended. For easier cleaning, wipe up any spillages immediately.

<b>Hotplate</b>		
<b>Part</b>	<b>Finish</b>	<b>Recommended Cleaning Method</b>
Hob top	Enamel or stainless steel	Hot soapy water, soft cloth. Any stubborn stains remove gently with a nylon scourer.
Ceramic/Induction hob	Toughened glass	Hot soapy water; cream cleaner/scourer if necessary.
Griddle plate (some models only)	Non-stick surface	Allow to cool. Wash in hot soapy water. Do not use abrasive cleaners/scourers. Dishwasher.
Warming zone (some models only)	Toughened glass	Hot soapy water, cream cleaner/scourer if necessary.
<b>Outside of Cooker</b>		
<b>Part</b>	<b>Finish</b>	<b>Recommended Cleaning Method</b>
Door, door surround and storage drawer exterior	Enamel or paint	Hot soapy water, soft cloth. Any stubborn stains, remove gently with a liquid detergent.
	Stainless steel	E-cloth (electrical retailers) or microfibre all-purpose cloth (supermarket).
Sides and plinth	Painted surface	Hot soapy water, soft cloth.
Splashback/rear grille	Enamel or stainless steel	Hot soapy water, soft cloth. Cream cleaner, with care, if necessary.
Control panel	Paint, enamel or stainless steel	Warm soapy water. Do not use abrasive cleaners on lettering.
Control knobs/handles & trims	Plastic/chrome, copper or lacquered brass	Warm soapy water, soft cloth.
	Brass	Brass polish.
Oven door glass/glass lid (some models only)	Toughened glass	Hot soapy water, cream cleaner/scourer if necessary.
<b>Oven and Grill</b>		
<b>Part</b>	<b>Finish</b>	<b>Recommended Cleaning Method</b>
Sides, floor & roof of oven NOT COOK & CLEAN OVEN PANELS (see below)	Enamel	Any proprietary oven cleaner that is suitable for enamel. CAUTION: CORROSIVE/CAUSTIC OVEN CLEANERS: FOLLOW MANUFACTURER'S INSTRUCTIONS. Do not allow contact with the oven elements.
Cook & Clean oven panels (some models only)	Special enamel that partly cleans itself	This surface cleans itself at 200°C and above, or the panels can be removed and washed with hot soapy water and a nylon brush.
Oven shelves, Handyrack, grill trivet, Handygrill rack (some models only)	Chrome	An oven interior cleaner that is suitable for chrome. Soap filled pad. Dishwasher.
Grill pan/meat tin (some models only)	Enamel	Hot soapy water. Soap filled pad. Dishwasher.

**Table 9.1**

## 10. Troubleshooting

---

**⚠ Interference with and repairs to the hob MUST NOT be carried out by unqualified persons. DO NOT try to repair the hob as this may result in injury and damage to the hob. Please arrange for repair by a suitably competent person.**

### **A crack has appeared in the hob surface**

Disconnect the cooker immediately from the power supply and arrange for its repair. **DO NOT** use the cooker until after the repair.

### **My hob is scratched**

Always use the cleaning methods recommended in this guide, and ensure that the pan bottoms are smooth and clean.

Marks from mineral deposits from water or food can be removed with a cleaning cream. However, tiny scratches are not removable but will become less visible in time as a result of cleaning.

### **The oven fan is noisy**

The note of the oven fan may change as the oven heats up – this is perfectly normal.

### **Grill not cooking properly**

Are you using the pan and trivet supplied with the cooker? Is the pan being used on the runners, not the floor of the compartment? Is the grill tray pushed back fully to the 'back stop' position?

### **The knobs get hot when I use the oven or grill. Can I avoid this?**

Yes, this is caused by heat rising from the oven or the grill, and heating them up. **DO NOT** leave the oven door open. Make sure that the grill pan is pushed right back to the 'back stop' when grilling.

Always grill with the grill compartment door open.

### **If there is an installation problem and I don't get my original installer to come back to fix it, who pays?**

You do. Service organisations will charge for their call-outs if they are correcting work carried out by your original installer. Therefore, it's in your own interest to keep track of this installer so that you can contact them as required.

### **Power failure**

In the event of a failure in the electrical supply, remember to reset the clock to ensure that the timed oven continues to operate.

### **Food is cooking too slowly, too quickly, or burning**

Cooking times may differ from your previous oven. Check that you are using the recommended temperatures and shelf positions – see the oven cooking guide. Then adjust the settings according to your own individual tastes.

### **The oven is not cooking evenly**

**DO NOT** use a baking tray with dimensions larger than those specified in the section on 'General Oven Tips'.

If you are cooking a large item, be prepared to turn it round during cooking.

If two shelves are used, check that space has been left for the heat to circulate. When a baking tray is put into the oven, ensure that it is placed centrally on the shelf.

Check that the door seal is not damaged and that the door catch is adjusted so that the door is held firmly against the seal.

A dish of water when placed on the shelf should be the same depth all over. (For example, if it is deeper at the back, then the back of the cooker should be raised up or the front lowered.) If the cooker is not level, arrange for your supplier to level it for you.

### **The timed oven is not coming on when turned on manually**

Is the power on? Is the clock illuminated? If not, there may be something wrong with the power supply. Is the cooker supply on at the isolator switch?

Has the time of day been set?

### **The timed oven is not coming on when automatic cooking**

Has the oven knob been left in the OFF position by mistake?

### **Oven temperature getting hotter as the cooker gets older**

If turning the temperature down using the oven control knob has not worked, or has only worked for a short time, then you may need a new thermostat. This should be fitted by a service person.

**Fig. 10.1**

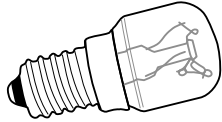

**The oven light is not working**

The bulb has probably blown. You can buy a replacement bulb (which is not covered under the guarantee) from most electrical stores. Ask for an Edison screw fitting 15W 230V lamp, FOR OVENS (**Fig. 10.1**). It must be a special bulb, heat resistant to 300 °C.

**Fig. 10.2**

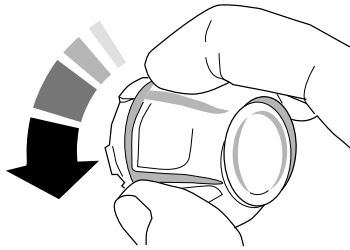

Before removing the existing bulb, turn off the power supply and make sure that the oven is cool. Open the oven door and remove the oven shelves.

Locate the bulb cover and unscrew it by turning it counter-clockwise – it may be very stiff (**Fig. 10.2**).

Taking care to protect your fingers with a glove in case the bulb should shatter, unscrew the old bulb.

Screw in the new bulb clockwise and then screw the bulb cover back on. Turn on the electricity supply and check that the bulb now lights.

**Fig. 10.3**

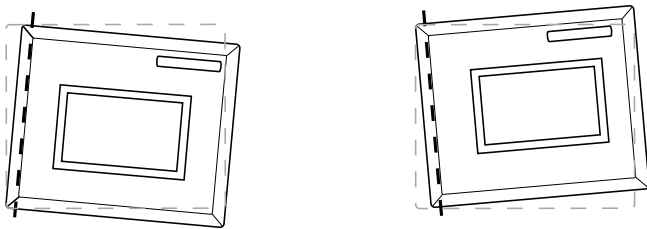

Effect of hinge adjustment – exaggerated for clarity

**The oven door is misaligned**

The bottom hinge of either oven door can be adjusted to alter the angle of the door (**Fig. 10.3**). Loosen the bottom hinge fixing screws and use the notch and a flat bladed screwdriver to move the position of the hinge to set the hinge position (**Fig. 10.4**).

Retighten the hinge screws.

**Fig. 10.4**

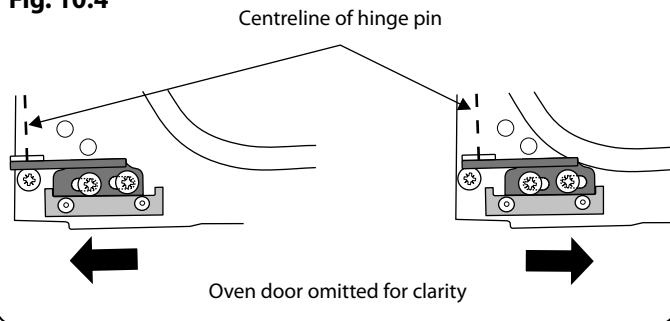



## INSTALLATION

Check the appliance is electrically safe when you have finished.

# 11. Installation

## Dear Installer

Before you start your installation, please complete the details below, so that, if your customer has a problem relating to your installation, they will be able to contact you easily.

<b>Installer's Name</b>
<b>Installer's Company</b>
<b>Installer's Telephone Number</b>
<b>Appliance Serial Number</b>

## Safety requirements and regulations

- ⚠ This cooker must be installed in accordance with the relevant instructions in this booklet, with the relevant national and local regulations, and with the local electricity supply companies' requirements.**
- ⚠ The appliance must be installed in accordance with the regulations in force and only in a well ventilated space.**
- ⚠ Read the instructions before installing or using this appliance.**

## Provision of ventilation

This appliance is not connected to a combustion products evacuation device. Therefore, particular attention must be given to the relevant requirements regarding ventilation.

All rooms require a window that can be opened, or equivalent, while some rooms require a permanent vent in addition to the window.

## Location of cooker

The cooker may be installed in a kitchen/kitchen diner but **NOT** in a room containing a bath or shower.

This appliance is designed for domestic cooking only. Use for any other purpose could invalidate any warranty or liability claim.

You will need the following equipment to complete the cooker installation satisfactorily:

- Multimeter (for electrical checks).

You will also need the following tools:

1. Steel tape measure
2. Cross-head screwdriver
3. Flat-bladed screwdriver
4. Spirit level
5. Pencil
6. Adjustable spanner
7. 3 mm and 4 mm Allen keys
8. 13 mm spanner or socket wrench

Checking the parts:

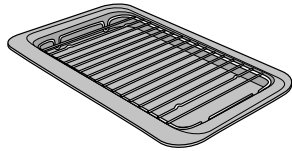
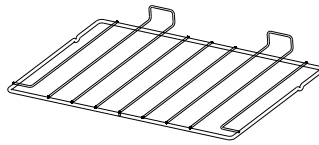
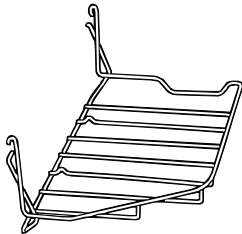
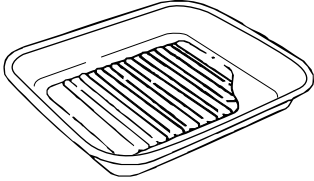
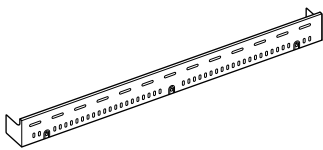
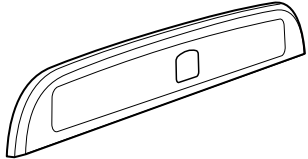
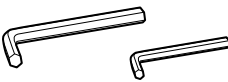
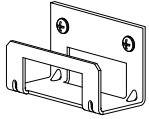
Grill pan and trivet (*depending on model)	Flat oven shelves
	
Handyrack	Roasting tin
	
Plinth (*depending on model)	Splashback (Classic and Classic Deluxe models)
	
Allen Keys	Stability location bracket
	
*Images may vary on different models	

## INSTALLATION

Check the appliance is electrically safe when you have finished.

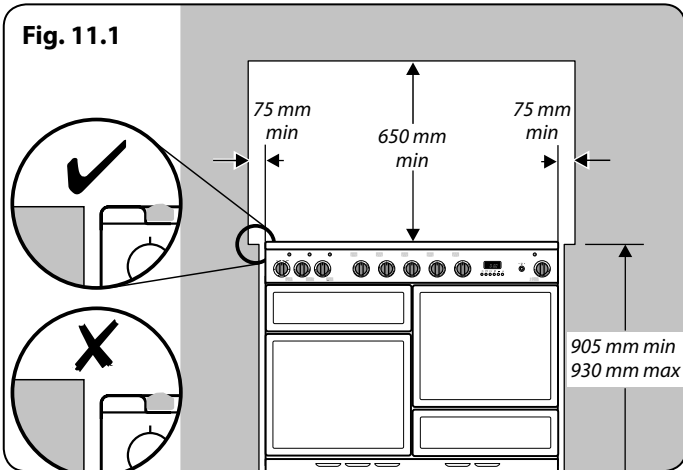

## Positioning the cooker

**Fig. 11.1** and **Fig. 11.2** show the minimum recommended distance from the cooker to nearby surfaces.

The cooker should not be placed on a base.

**Fig. 11.1** and **Fig. 11.2** Cookers installed into recess: The cooker must have side clearance **ABOVE** hob level of 75mm up to a height of 410mm. This can be reduced to 25mm if the surface of the side wall is non-combustible.

\*Any cookerhood should be installed in accordance with the hood manufacturer's instructions.

\*\*Any splashback must be fitted in accordance with the manufacturers instructions. Allowance should be made for the additional height of the flue trim, which is fitted to the cooker hob.

Surfaces of furniture and walls at the sides and rear of the appliance should be heat, splash and steam resistant. Certain types of vinyl or laminate kitchen furniture are particularly prone to heat damage and discolouration. We cannot accept responsibility for damage caused by normal use of the cooker to any material that de-laminates or discolours at temperatures less than 65 °C above room temperature.

**DO NOT** box the cooker in – it must be possible to move the cooker in and out for cleaning and servicing.

If the cooker is near a corner of the kitchen, a clearance of 130 mm is required to allow the oven doors to open (**Fig. 11.3**). The actual opening of the doors is slightly less, but this allows for some protection of your hand as you open the door.

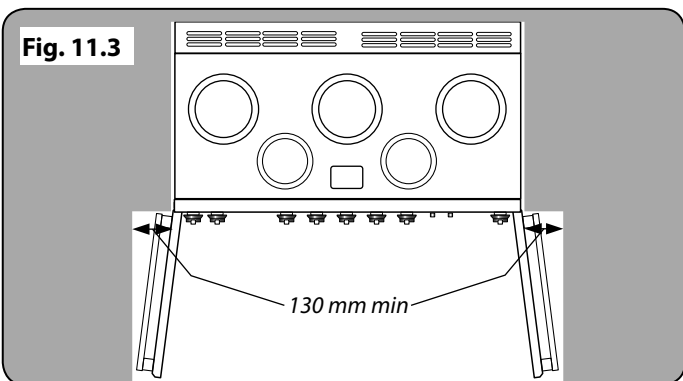
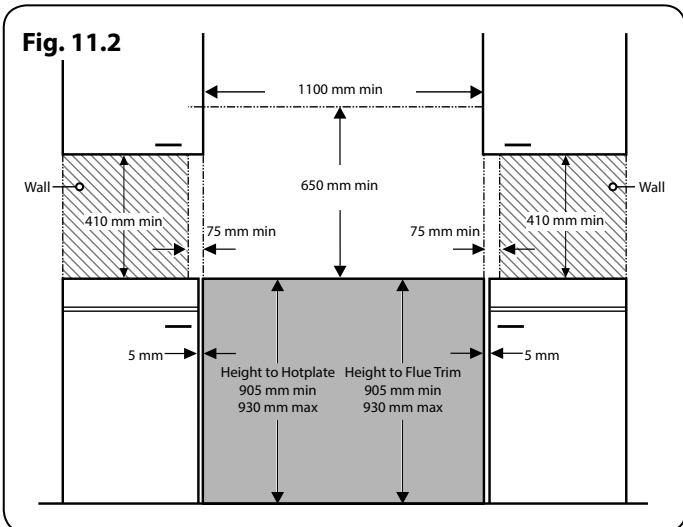

## Moving the cooker

**⚠ On no account try and move the cooker while it is plugged into the electricity supply.**

**⚠ The cooker is very heavy, so take great care.**

We recommend two people manoeuvre the cooker. Make sure that the floor covering is firmly fixed, or removed to prevent it being disturbed when moving the cooker around. To help you, there are two levelling rollers at the back and two screw-down levelling feet at the front.

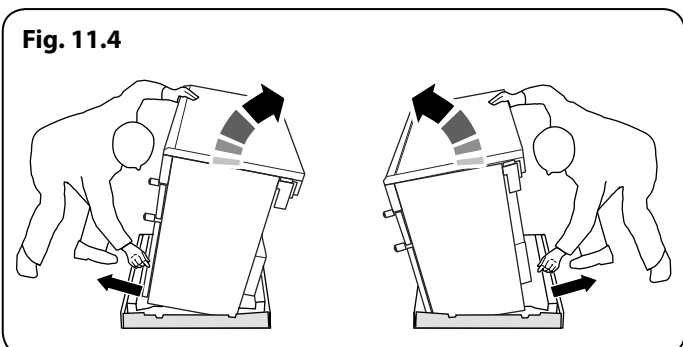

Remove the polystyrene base pack. From the front, tilt the cooker backwards and remove the front half of the polystyrene base (**Fig. 11.4**). Repeat from the back and remove the rear half of the polystyrene base.

## INSTALLATION

Check the appliance is electrically safe when you have finished.

### Lowering the two rear rollers

To adjust the height of the rear of the cooker, first fit a 13 mm spanner or socket wrench onto the hexagonal adjusting nut (Fig. 11.5).

Rotate the nut – clockwise to raise – counter-clockwise to lower. Make 10 complete (360°) turns clockwise.

Make sure you lower BOTH REAR ROLLERS.

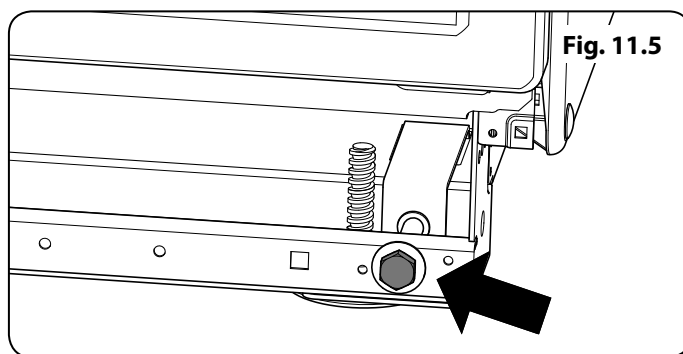

### Completing the move

Unfold the rear edge of the cardboard base tray. Open the grill door and right-hand oven door so that you can get a good grip on the bottom of the fascia panel as you move the oven (Fig. 11.6).

Carefully push the cooker backwards off the base tray. Remove the base tray.

Position the cooker close to its final position, leaving just enough space to get behind it (Fig. 11.7).

**⚠ DO NOT use the door handles or control knobs to manoeuvre the cooker.**

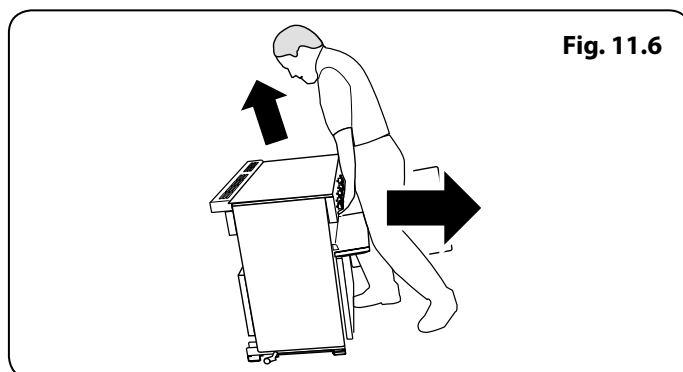

### Repositioning the cooker following connection

If you need to move the cooker once it has been connected, make sure it is switched off at the supply switch before gripping under the fascia panel and lifting the front of the cooker slightly (Fig. 11.6). Check behind the cooker to make sure that the electricity cable is not caught. As you progress, always make sure that the cable has sufficient slack to allow the cooker to move.

When you replace the cooker, check behind it again once more to make sure that the electricity cable is not caught or trapped.

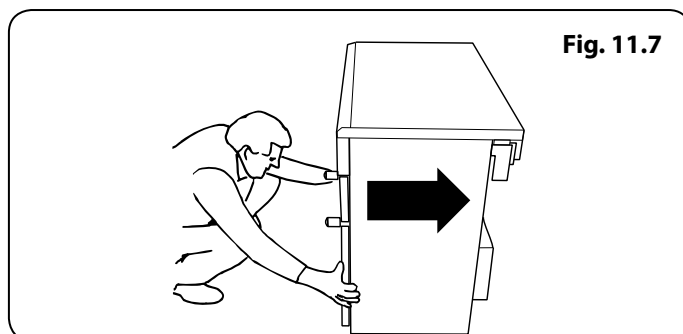

### Levelling the cooker

Place the cooker in its intended position. Take care not to twist it within the gap between the kitchen units, as otherwise, damage may occur to the cooker or units.

There are two screw-down feet at the front and two levelling rollers at the rear, which can be used to adjust the height and level of the cooker.

It is recommended that you use a spirit level on a shelf in one of the ovens to check for level.

## INSTALLATION

Check the appliance is electrically safe when you have finished.

### Current Operated Earth Leakage Breakers

The combined use of your induction cooker and other domestic appliances may cause nuisance tripping, so we recommend that the cooker is protected on an individual RCD (Residual Current Device) or RCBO (Residual Current Breaker with Overload).

**IF IN DOUBT, PLEASE CONSULT A SUITABLY QUALIFIED ELECTRICIAN.**

Fig. 11.8

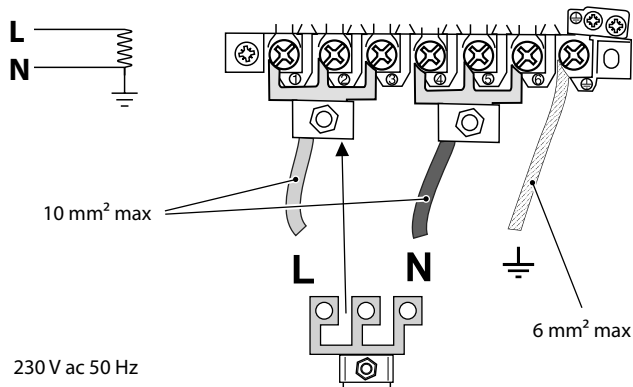
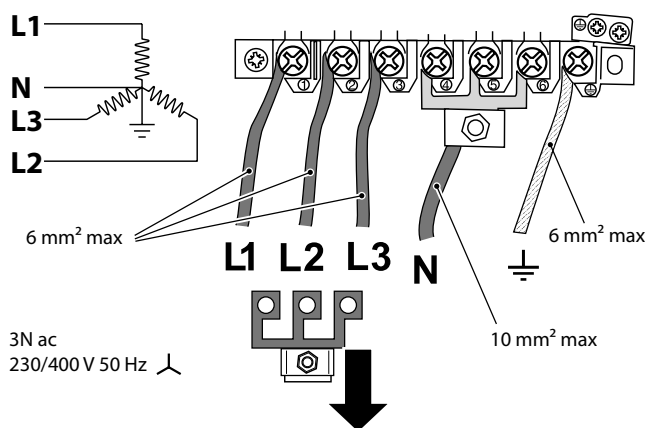

Fig. 11.9



## Electrical connection

The cooker must be installed by a qualified electrician, in accordance with all relevant British Standards/Codes of Practice (in particular BS 7671), or with the relevant national and local regulations.

**⚠ WARNING: THE APPLIANCE MUST BE EARTHED.**

**Note:** The cooker must be connected to the correct electrical supply as stated on the voltage label on the cooker, through a suitable cooker control unit incorporating a double-pole switch, having a contact separation of at least 3 mm in all poles.

**⚠ The cooker MUST NOT be connected to an ordinary domestic power point.**

Access to the mains terminal is gained by removing the electrical terminal cover box on the back panel. Connect the mains cable to the correct terminals for your electrical supply type (**Fig. 11.8** and **Fig. 11.9**). Check that the links are correctly fitted and that the terminal screws are tight. Secure the mains cable using the cable clamp.

## Final checks

### Hob check

Check each cooking zone in turn. Be sure to use pans of the correct size and material.

### Grill check

Turn on the grill control and check that the grill heats up.

### Oven check

Set the clock as described earlier, and then turn on the ovens. Check the oven fans start to turn and that the ovens heat up.

## INSTALLATION

Check the appliance is electrically safe when you have finished.

### Final fitting

#### Fitting the handles and handrail (depending on model)

Remove the 4 mm Allen screws from the doors (**Fig. 11.10**). Fit the door handles and secure using the 4 mm screws.

**⚠ The handles should be above the fixings.**

Remove the 4 mm Allen screws from the top corners of the fascia (**Fig. 11.11**). Fit the front handrail in position and secure using the 4 mm screws.

#### Fitting the 1-piece plinth

Loosen the three screws along the front bottom edge of the cooker. Hook the central keyhole over the central screw. Twist and fit each end keyhole over their respective screws. Tighten the fixing screws (**Fig. 11.12**).

#### Fitting the 2-piece plinth

Fit the inner plinth to the bottom front of the cooker using the 4 screws provided (**Fig. 11.13**).

Fit the outer plinth (2 screws, 1 each end) to the inner plinth. The height of the outer plinth can be adjusted by sliding it up or down via the slotted hole (**Fig. 11.14**).

#### Fitting the splashback (optional)

Position the splashback on the rear of the hotplate and secure with the screws supplied.

### Customer care

**Installer:** Please complete your details in this guide, inform the user how to operate the cooker and hand over the instructions.

Thank you.

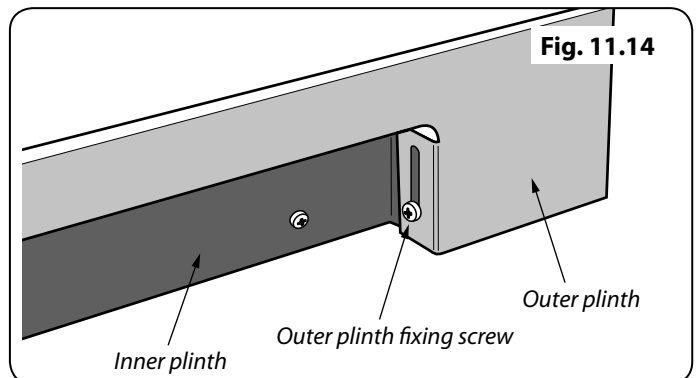
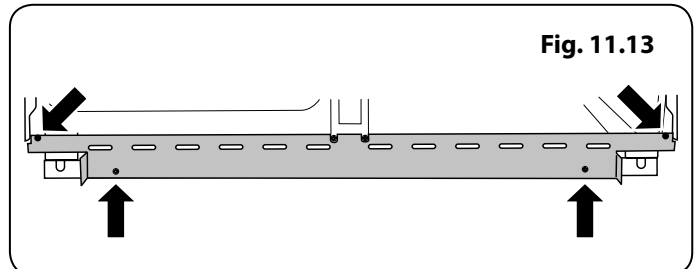
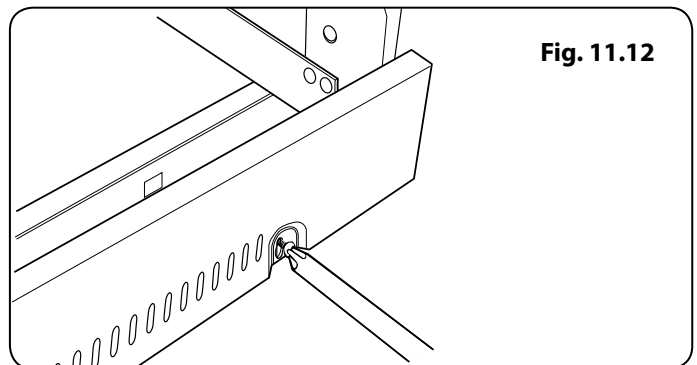
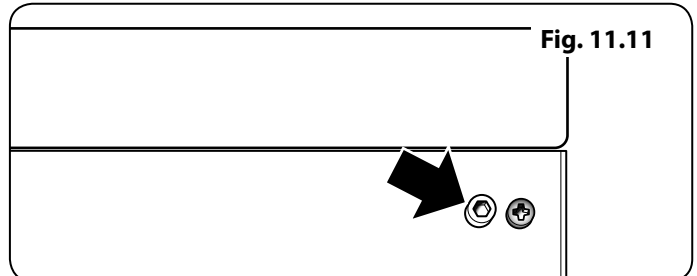
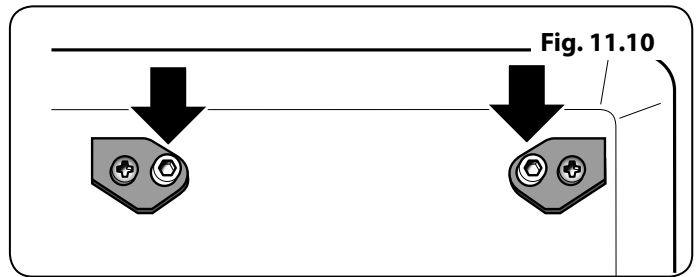

# 12. Circuit diagrams

## Hob Classic Deluxe

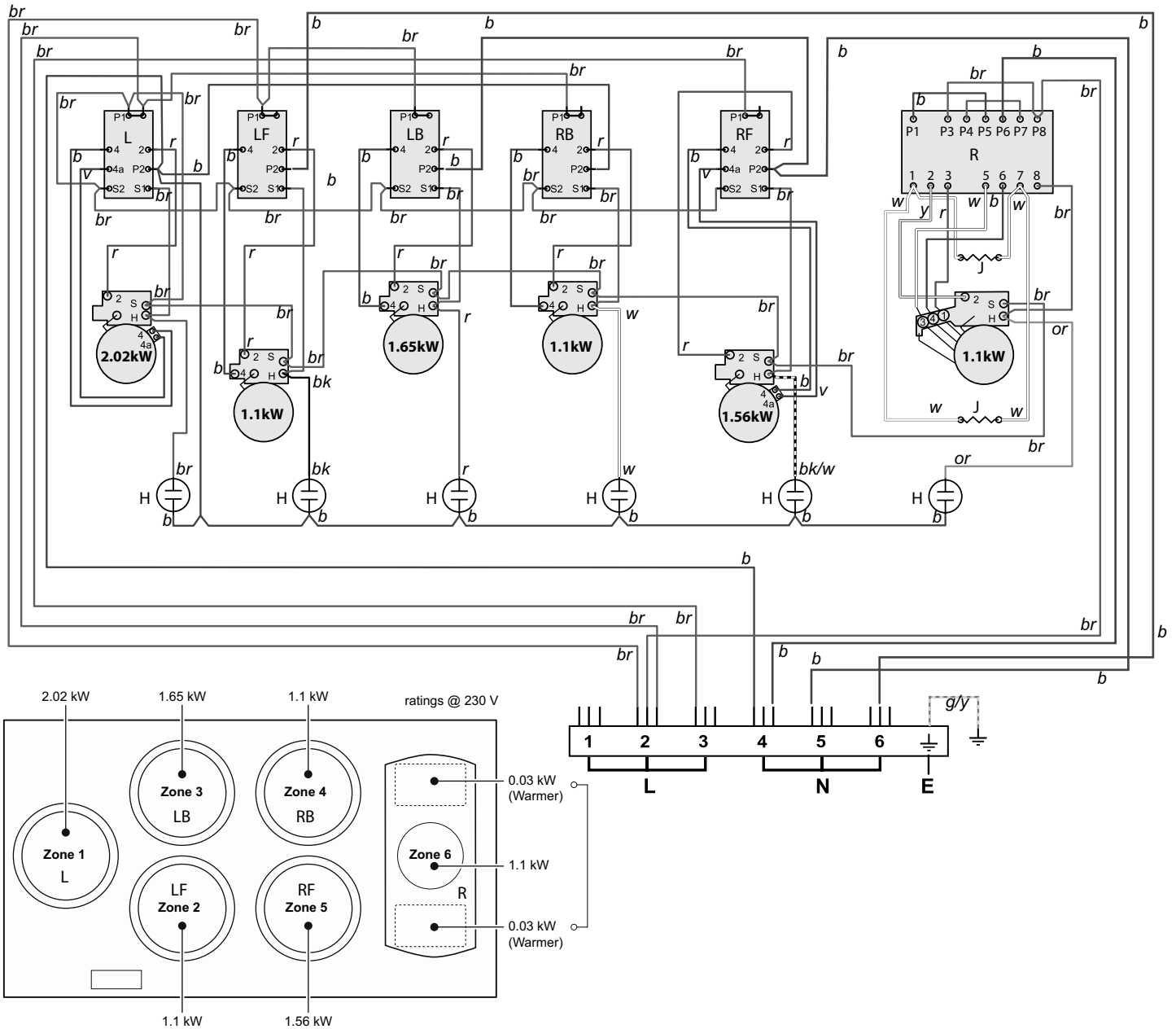

Connections shown in the circuit diagram are for single-phase. The ratings are for 230V 50Hz.

Code	Description
L	Left Ceramic Zone Control
LB	Left Back Ceramic Zone Control
LF	Left Front Ceramic Zone Control
RB	Right Back Ceramic Zone Control
RF	Right Front Ceramic Zone Control
R	Right Ceramic Zone Control
H	Indicator Neon
J	Warmer Zone Elements

Code	Colour
b	Blue
br	Brown
bk	Black
or	Orange
r	Red
v	Violet
w	White
y	Yellow
g/y	Green/yellow
gy	Grey
bk/w	Black / white

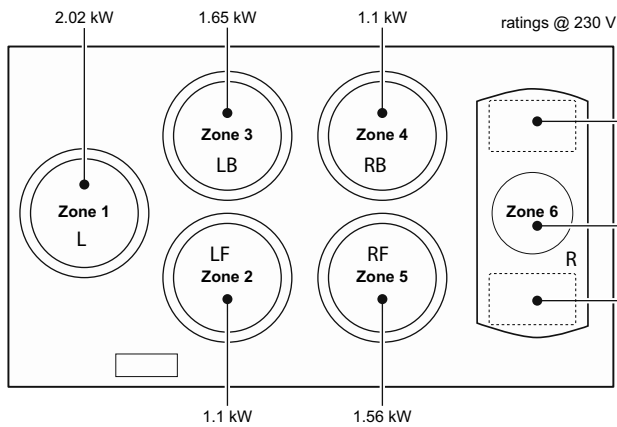
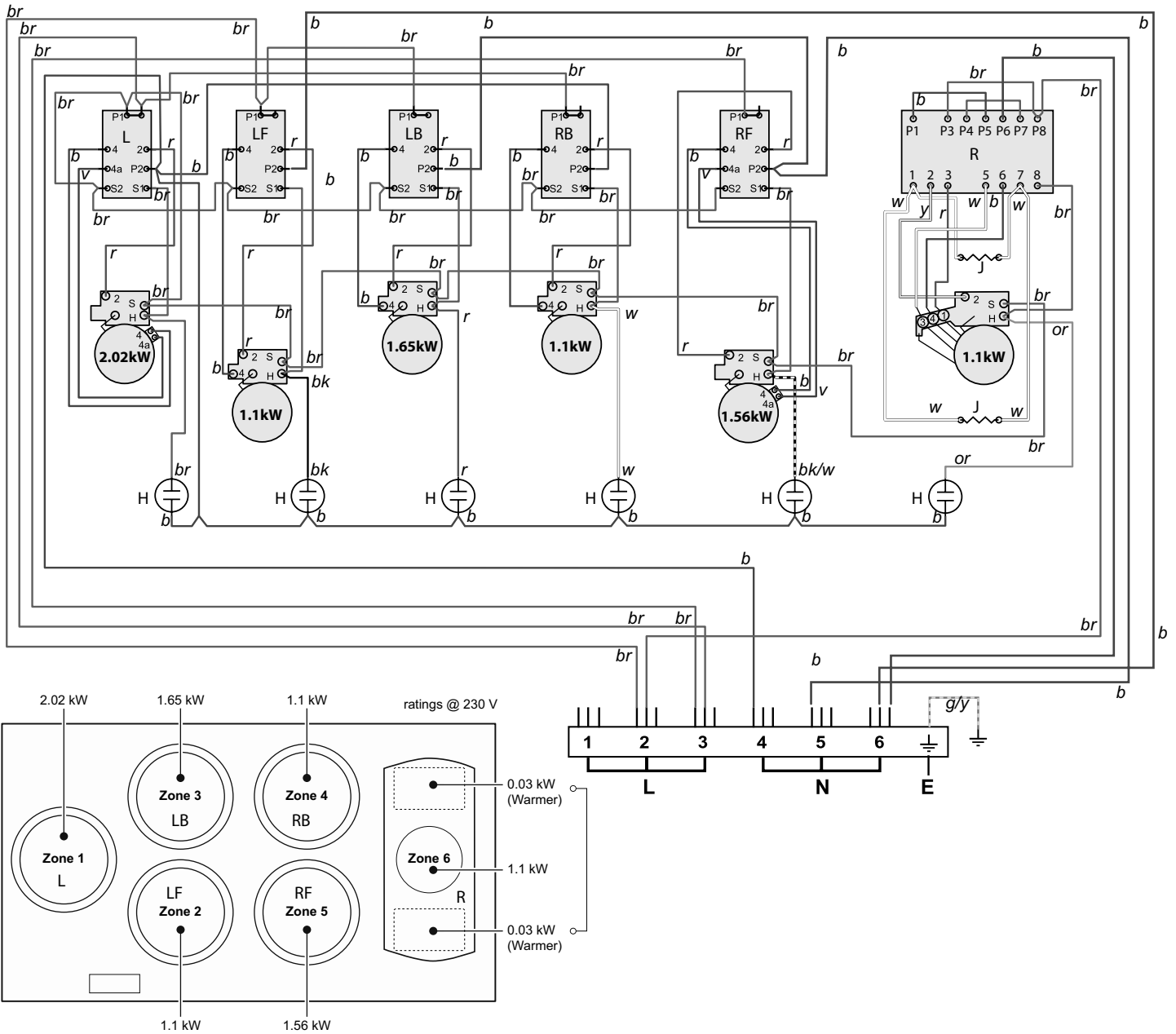

Connections shown in the circuit diagram are for single-phase. The ratings are for 230V 50Hz.

Code	Description
<b>L</b>	Left Ceramic Zone Control
<b>LB</b>	Left Back Ceramic Zone Control
<b>LF</b>	Left Front Ceramic Zone Control
<b>RB</b>	Right Back Ceramic Zone Control
<b>RF</b>	Right Front Ceramic Zone Control
<b>R</b>	Right Ceramic Zone Control
<b>H</b>	Indicator Neon
<b>J</b>	Warmer Zone Elements

Code	Colour
<b>b</b>	Blue
<b>br</b>	Brown
<b>bk</b>	Black
<b>or</b>	Orange
<b>r</b>	Red
<b>v</b>	Violet
<b>w</b>	White
<b>y</b>	Yellow
<b>g/y</b>	Green/yellow
<b>gy</b>	Grey
<b>bk/w</b>	Black / white

# Multifunction oven *Classic Deluxe*

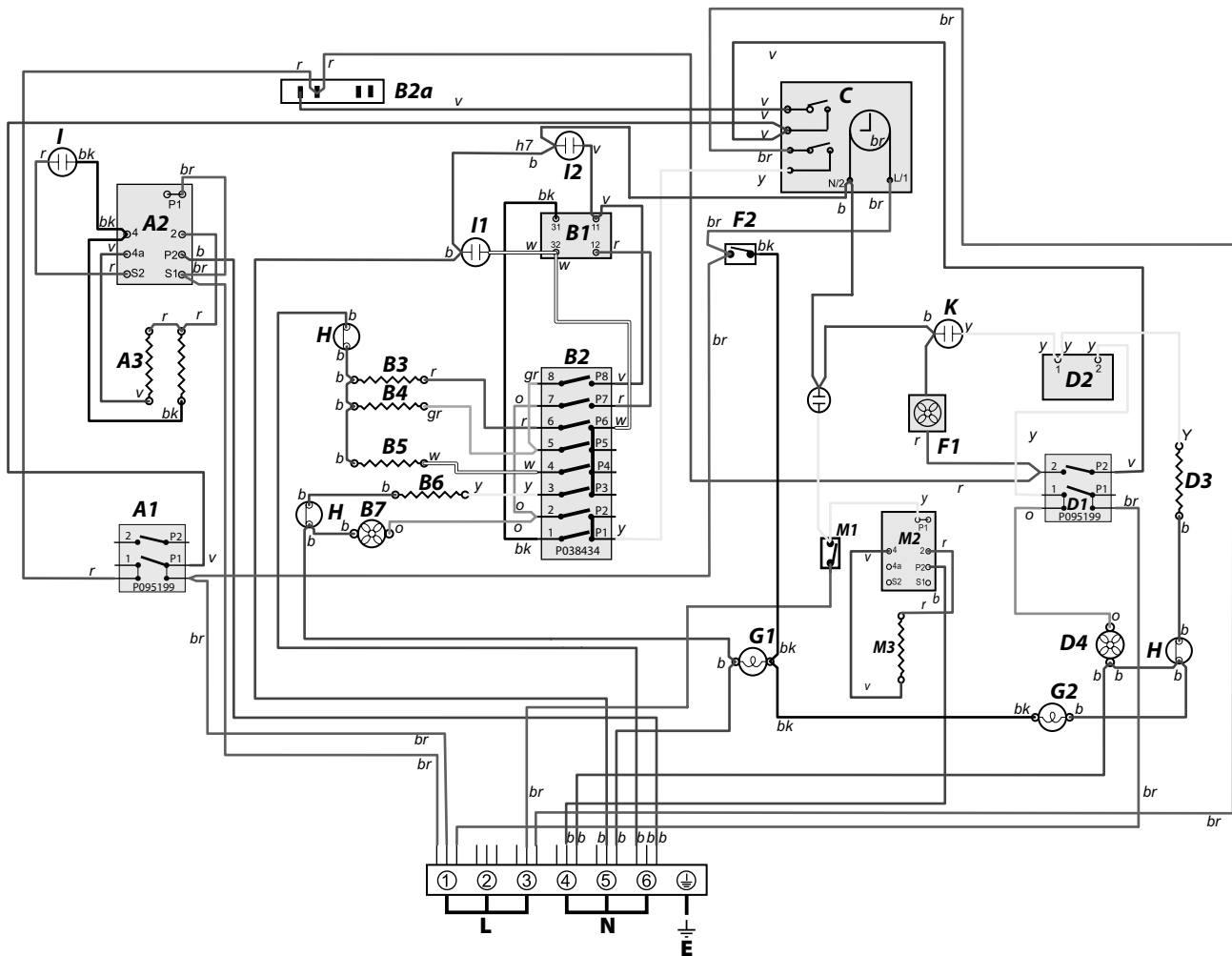

The connections shown in the circuit diagram are for single-phase. The ratings are for 230V 50Hz.

Code	Description
<b>A1</b>	Grill Energy Regulator
<b>A2</b>	Grill Elements
<b>A3</b>	Grill Front Switch
<b>B1</b>	Left Hand Multi Function Oven Thermostat
<b>B2</b>	Left Hand Multi Oven Control
<b>B2a</b>	Left Hand Multi Function Oven Thermostat front Switch
<b>B3</b>	Left Hand Multi Function Oven Base Element
<b>B4</b>	Left Hand Multi Function Oven Top Element (Outer Pair)
<b>B5</b>	Left Hand Multi Function Oven Top Element (Inner Pair)
<b>B6</b>	Left Hand Multi Function Oven Fan Element
<b>B7</b>	Left Hand Multi Function Oven Fan
<b>C</b>	Clock
<b>D1</b>	Right Hand Oven Front Switch
<b>D2</b>	Right Hand Oven Thermostat

Code	Description
<b>D3</b>	Right Hand Oven Element
<b>D4</b>	Right Hand Oven Fan
<b>F1</b>	Cooling Fan
<b>F2</b>	Oven Light Switch
<b>G1</b>	Left-hand oven light
<b>G2</b>	Right-hand oven light
<b>H</b>	Thermal Cut Out
<b>I</b>	Grill Neon
<b>I1</b>	Multi Function Neon
<b>I2</b>	Rapid Heat Neon
<b>K</b>	Right Hand Oven Neon
<b>M1</b>	Proving Draw Switch
<b>M2</b>	Proving Draw Energy Regulator
<b>M3</b>	Proving Draw Element

Code	Colour
<b>b</b>	Blue
<b>br</b>	Brown
<b>bk</b>	Black
<b>or</b>	Orange
<b>r</b>	Red
<b>v</b>	Violet
<b>w</b>	White
<b>y</b>	Yellow
<b>g/y</b>	Green/yellow
<b>gy</b>	Grey



# Conventional oven *Classic, Kitchener and Professional+*

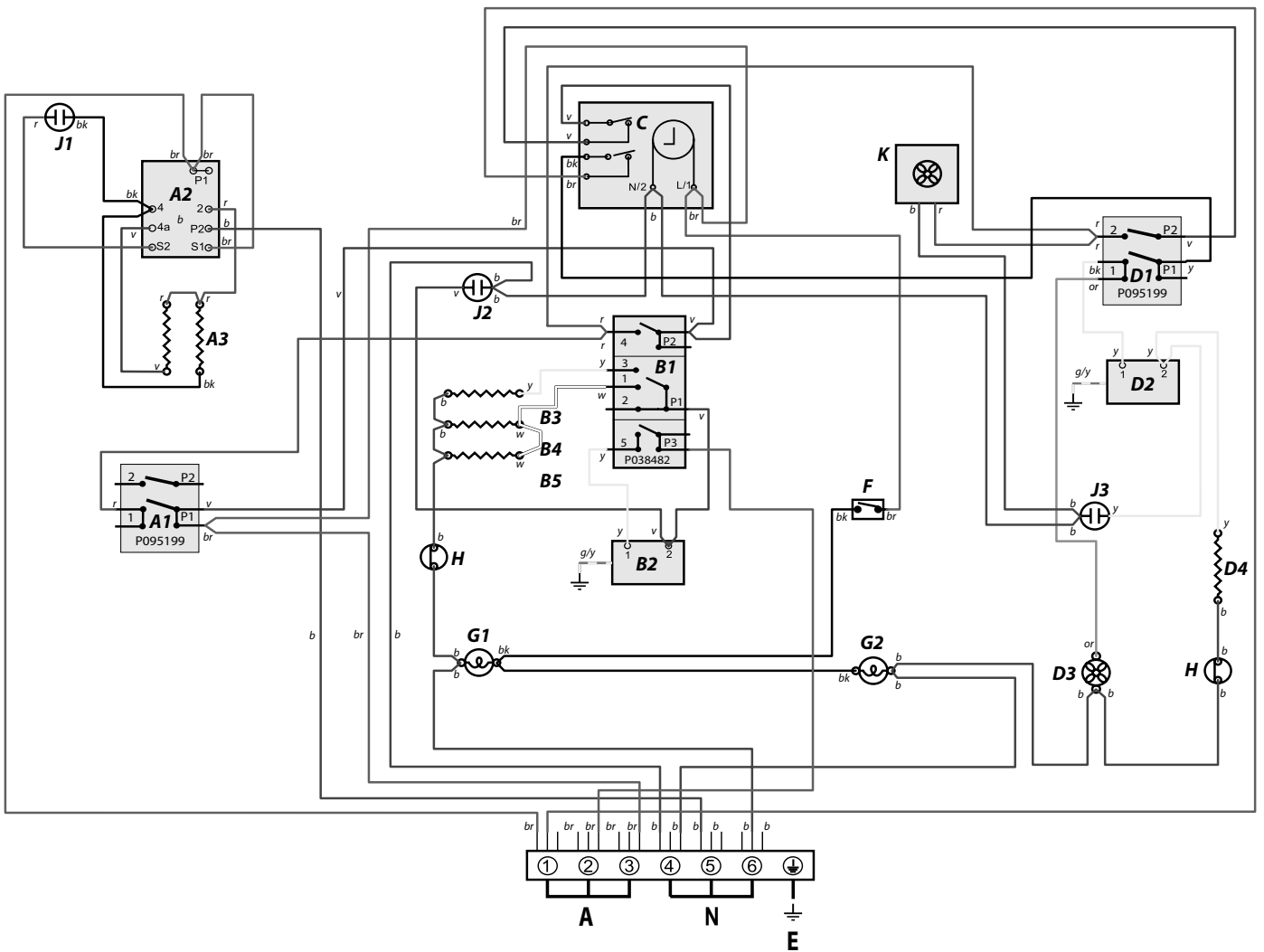

The connections shown in the circuit diagram are for single-phase. The ratings are for 230V 50Hz.

Code	Description
<b>A1</b>	Grill front switch
<b>A2</b>	Grill energy regulator
<b>A3</b>	Grill elements
<b>B1</b>	Zoned oven front switch
<b>B2</b>	Zoned oven thermostat
<b>B3</b>	Zoned oven browning element (inner pair)
<b>B4</b>	Zoned oven top element (outer pair)
<b>B5</b>	Zoned oven base element
<b>C</b>	Clock

Code	Description
<b>D1</b>	Right-hand oven front switch
<b>D2</b>	Right-hand oven thermostat
<b>D3</b>	Right-hand fan oven element
<b>D4</b>	Right-hand oven element
<b>F</b>	Oven light switch
<b>G1</b>	Left-hand oven light
<b>G2</b>	Right-hand oven light
<b>H</b>	Thermal cut-out
<b>J1</b>	Grill Neon
<b>J2</b>	Zoned Oven Neon
<b>J3</b>	Right-hand Oven Neon
<b>K</b>	Cooling fan

Code	Colour
<b>b</b>	Blue
<b>br</b>	Brown
<b>bk</b>	Black
<b>or</b>	Orange
<b>r</b>	Red
<b>v</b>	Violet
<b>w</b>	White
<b>y</b>	Yellow
<b>g/y</b>	Green/yellow
<b>gy</b>	Grey

## 13. Technical data

**INSTALLER:** Please leave these instructions with the user.

**DATA BADGE LOCATION:** Back of the cooker, serial number repeater badge below oven door opening.

**COUNTRY OF DESTINATION:** GB, IE.

### Connections

Electric	230 / 400V ~ 50 Hz 3N
----------	-----------------------

### Dimensions

Total height	Min 905 mm	Max 930 mm
Total width	1100 mm	
Total depth: Classic	608 mm excluding handles, 670 mm including handles	
Total depth: Classic Deluxe	608 mm excluding handles, 670 mm including handles	
Total depth: Kitchener	608 mm excluding handles, 656 mm including handles	
Total depth: Professional +	608 mm excluding handles, 646 mm including handles	

### Hotplate ratings

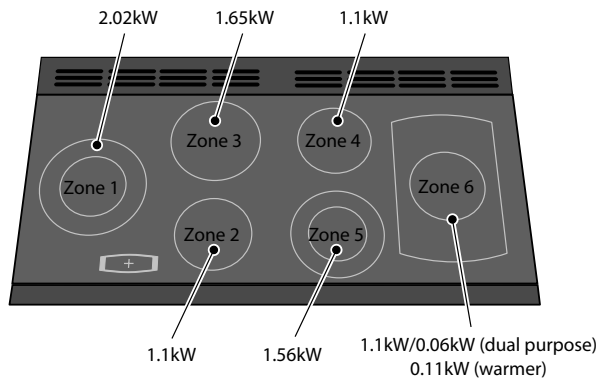

These ratings are specified at 230 V.

Hotplate energy saving tips	Oven energy saving tips
Use cookware with a flat base.	Cook meals together, if possible.
Use the correct size cookware.	Keep the pre-heating time short.
Use cookware with a lid.	<b>DO NOT</b> lengthen cooking time.
Minimise the amount of liquid or fat.	<b>DO NOT</b> open the oven door during the cooking period.
When liquid starts boiling, reduce the setting.	<b>DO NOT</b> forget to turn the appliance off at the end of cooking.

## Hotplate efficiency data

Brand	Rangemaster
Model Identification	Classic
	Classic Deluxe
	Kitchener
	Professional+
Size	110
Type	Ceramic

Type of Hob	Radiant
Number of electric zones	6
Zone 1 - Ø cm	14.5
Heating Technology	-
Energy Consumption (ECElectric cooking) - Wh/kg	175
Zone 2 - Ø cm	14.5
Heating Technology	-
Energy Consumption (ECElectric cooking) - Wh/kg	180
Zone 3 - Ø cm	18.5
Heating Technology	-
Energy Consumption (ECElectric cooking) - Wh/kg	177
Zone 4 - Ø cm	14.5
Heating Technology	-
Energy Consumption (ECElectric cooking) - Wh/kg	180
Zone 5 - Ø cm	18.5
Heating Technology	-
Energy Consumption (ECElectric cooking) - Wh/kg	177
Zone 6 - Ø cm	14.5
Heating Technology	-
Energy Consumption (ECElectric cooking) - Wh/kg	180
Energy Consumption (ECElectric hob) - Wh/kg (*)	178

Information marked thus (\*) is not required with mixed fuel hobs

## Oven data

Brand		Rangemaster
Model identification		Classic
		Kitchener
		Professional+
Mass	kg	117
Type of oven		Electric
Number of cavities		2
<b>Left-hand Efficiency</b>		
Fuel type		Electric
Cavity type		Convection
Power - conventional		2.2
Power - forced air convection		-
Volume	Litres	80
Energy consumption (electricity) - conventional	kWh / cycle	1.03
Energy consumption (electricity) - forced air convection	kWh / cycle	-
Energy efficiency index - conventional		116.3
Energy efficiency index - forced air convection		-
Energy class		B
<b>Right-hand Efficiency</b>		
Fuel type		Electric
Cavity type		Fanned
Power - conventional		-
Power - forced air convection		2.5
Volume	Litres	73
Energy consumption (electricity) - conventional	kWh / cycle	-
Energy consumption (electricity) - forced air convection	kWh / cycle	0.8
Energy efficiency index - conventional		-
Energy efficiency index - forced air convection		96.2
Energy class		A

<b>Additional Information</b>		
The oven complies with EN 60350-1		
Maximum output @ 230V 50Hz		
Conventional		2.2 kW
Multifunction		2.5 kW
Multifunction (with Rapid Response)		-
Forced Air Convection		2.5 kW
Grill		2.3 kW
Slow Oven		-
Bread Proving Drawer		-

<b>Maximum total electrical load at 230 V</b> (approximate total including hob, oven lights, oven fan, etc.):	16.0 kW
---	---------

## Oven data

Brand		Rangemaster
Model identification		Classic Deluxe
Mass	kg	118
Type of oven		Electric
Number of cavities		2
<b>Left-hand Efficiency</b>		
Fuel type		Electric
Cavity type		Multifunction
Power - conventional		2.2
Power - forced air convection		2.5
Volume	Litres	73
Energy consumption (electricity) - conventional	kWh / cycle	1.08
Energy consumption (electricity) - forced air convection	kWh / cycle	0.91
Energy efficiency index - conventional		126.1
Energy efficiency index - forced air convection		106.2
Energy class		A
<b>Right-hand Efficiency</b>		
Fuel type		Electric
Cavity type		Fanned
Power - conventional		-
Power - forced air convection		2.5
Volume	Litres	73
Energy consumption (electricity) - conventional	kWh / cycle	-
Energy consumption (electricity) - forced air convection	kWh / cycle	0.8
Energy efficiency index - conventional		-
Energy efficiency index - forced air convection		96.2
Energy class		A

<b>Additional Information</b>		
The oven complies with EN 60350-1		
Maximum output @ 230V 50Hz		
Conventional		2.2 kW
Multifunction		2.5 kW
Multifunction (with Rapid Response)		3.7 kW
Forced Air Convection		2.5 kW
Grill		2.3 kW
Slow Oven		-
Bread Proving Drawer		-

<b>Maximum total electrical load at 230 V</b> (approximate total including hob, oven lights, oven fan, etc.):	
Classic Deluxe (with Rapid Response)	17.4 kW



Name of Appliance & Colour*				
Appliance Serial Number*				
Fuel Type*	Natural Gas	<input type="checkbox"/>	LP Gas	<input type="checkbox"/>
	Dual Fuel	<input type="checkbox"/>	Electric	<input type="checkbox"/>
Retailer's Name & Address				
Date of Purchase				
Installer's Name & Address				
Installer's Telephone Number				
Date of Installation				

\*This information is on the appliance data badge - look in the appliance instructions to find out where the data badge is located.

### For warranty compliance, the requirements are that the appliance:

- Has been correctly installed in accordance with current legislation, relevant British and European Standards and Codes of Practice, by a suitably competent person registered with Gas Safe or equivalent body and, where applicable, a qualified electrician.
- Has been used solely for domestic cooking purposes.
- If in use in the UK\*, has not been taken abroad as a personal export. (In the Republic of Ireland conditions may vary, so consult your retailer.)
- Is not second-hand or a refurbished appliance. The manufacturer's warranty is not transferable.
- Has not been subject to misuse, accidental damage or modification, and has not deteriorated due to normal domestic wear and tear, and the manufacturer's recommendations concerning cleaning materials have been followed.
- Has not been repaired by persons or organisations other than those authorised to act on behalf of AGA Rangemaster.

### Exceptions:

- Items not included under the free 1 year guarantee include pan supports, griddles, wok rings, baking trays, grill pans, trivets, filters, light bulbs and other consumable accessories.
- Any damage caused other than through normal use.
- Breakdowns associated with cooking spillage.
- Cosmetic deterioration deemed to be normal wear and tear.

### This warranty is in addition to your Statutory Rights.

\* Only certain models can be adapted for use with Mains Gas supplied in the Channel Islands and Isle of Man.

## OUT OF WARRANTY

We recommend that Rangemaster appliances are serviced regularly throughout their life to maintain optimum performance and efficiency. Service work should only be carried out by technically competent and suitably qualified personnel.

For your own safety, always make sure that work is carried out by a Gas Safe registered engineer for gas appliances or an approved electrician for electrical models.

For a competitive quote and to arrange for a Rangemaster approved engineer to attend, call Consumer Services on: 0800 804 6261 or 0370 789 5107 from a mobile.

## SPARE PARTS

To maintain optimum and safe performance, we recommend that only genuine Rangemaster spare parts are used. These are available from most major spares stockists, including ourselves.

Contact Consumer Services on 0800 804 6261 or 0370 789 5107 from a mobile, who will be happy to help.

## STANDARDS

Rangemaster cookers are designed and manufactured to a recognised international quality standard, which meets the requirements of BS EN ISO 9001, BS EN ISO 14001 and OHSAS 18001 for continually improving environmental procedures.

Rangemaster cookers comply with the essential requirements of the appropriate European Directives, and carry the CE mark.

## CONSUMER SERVICE

If you have any product enquiries, or in the event of a problem with your appliance once it has been installed, please telephone 0800 804 6261 or 0370 789 5107 from a mobile.

## CONSUMER SERVICE LINES OPEN:

Monday to Thursday 8am-6pm

Friday 8am-5pm

## WARRANTY

Your manufacturer warranty covers goods of our own brand for defective workmanship and materials for a period of 1 year from the date of purchase. This warranty covers mechanical breakdown and proven cosmetic and manufacturing defects.

You will receive an additional FREE full 12 months guarantee by registering your purchase using the FREEPOST form provided. Alternatively, call free on 0800 587 5747, quoting reference RMGX57A, or register online at [www.rangemaster.co.uk](http://www.rangemaster.co.uk).

Any damage, blemishes or chips identified upon receipt of the product must be reported within 90 days - proof of purchase may be required to establish validity. Scratches on the surface of ceramic hobs must be reported within 14 days. Scratches caused by usage are not covered. Accidental damage is not covered by the manufacturer's warranty.

*Designed to impress*  
**The Co-ordinating Collection.**

• Refrigeration • Sinks & Taps • Hoods & Splashbacks • Built-in Cooking • Dishwashing



Built from experience

Clarence Street  
Royal Leamington Spa  
Warwickshire  
CV31 2AD  
England

Consumer Services: +44 (0)800 804 6261 or (0)370 789 5107 from a mobile.

Fax: +44 (0)1926 450526

E-mail: [consumers@agarangemaster.co.uk](mailto:consumers@agarangemaster.co.uk)

[www.rangemaster.co.uk](http://www.rangemaster.co.uk)

For UK Trade Enquiries Tel: +44 (0)115 946 4000

Fax: +44 (0)115 973 6602

E-mail: [sales@agarangemaster.co.uk](mailto:sales@agarangemaster.co.uk)

For ROI Enquiries Tel: 1850 302 502

Rangemaster is a trading name of AGA Rangemaster Limited

Registered in England and Wales. Registration No. 354715

Registered Office: c/o Aga Rangemaster, Meadow Lane, Long Eaton, Nottingham, NG10 2GD

**AGA RANGemaster**



Rangemaster continuously seeks improvements in specification, design and production of products and thus, alterations take place periodically. Whilst every effort is made to produce up-to-date literature, this brochure should not be regarded as an infallible guide to current specification, nor does it constitute an offer for the sale of any particular appliance.

