



CARPET WASHER

Model # DDW03-E01



1·2·3...

USER GUIDE



LET'S GO.™

WARNING

BASIC SAFETY PRECAUTIONS

This carpet washer is intended for household use only and NOT for commercial or industrial use.

- Only use the carpet washer indoors and keep the area you're cleaning well lit.
- Keep fingers, hair and loose clothing away from moving parts and openings whilst using the carpet washer.
- This appliance can be used by children aged from 8 years and above and persons with reduced physical, sensory or mental capabilities or lack of experience and knowledge if they have been given supervision or instruction concerning use of the appliance in a safe way and understand the hazards involved. Children shall not play with the appliance. Cleaning and user maintenance shall not be made by children without supervision.
- Before using the carpet washer test your carpets/rugs/upholstery for colourfastness and pile distortion.
- Only Dirt Devil recommended tools and solution should be used with this carpet washer. Using other solutions may invalidate the guarantee.

DON'TS

- Don't leave the carpet washer plugged in when unattended.
- Don't use this carpet washer if it has been dropped, damaged or left outdoors.
- Don't run over the power cord or use carpet washer if the power cord or plug is damaged. Please contact our Customer Care Line on: 0330 026 2626 (Mon-Fri 9:00am to 5:00pm).
- Don't use your carpet washer to pick up any flammable or combustible materials (lighter fluid, petrol, kerosene etc.) or use the carpet washer in an area with explosive vapours or liquid.
- Don't handle the plug or use the carpet washer with wet hands.
- Don't carry the carpet washer while it's switched on.
- Don't pull or carry this carpet washer by the power cord.
- Don't use the power cord as a handle, pull the power cord around corners, sharp edges or close a door over the power cord. Don't unplug carpet washer by pulling on the power cord.
- Don't attempt to remove blockages with sharp objects as this may cause damage to your carpet washer.





WARNING



DON'TS CONTINUED...

- Don't use your carpet washer to pick up hot coals, cigarette butts, matches or smoking hot burning items or use in an area where there may be harmful fluids (chlorine, bleach, and ammonia drain cleaner).
- Don't use the carpet washer with incorrect voltage as this may result in damage or injury to the user. The correct voltage is listed on the ratings label.

DO'S

- Check with the manufacturer of your flooring prior to using the carpet washer to ensure its suitability.
 - The clean water tank should be filled with warm water (max 40C) only. Filling the clean water tank with hot or boiling water will damage the machine and invalidate the guarantee.
 - Always vacuum your carpets thoroughly before using the carpet washer.
 - Always unplug the carpet washer before carrying out any maintenance and before connecting or disconnecting the hose/accessories.
 - Turn off all controls on the carpet washer before disconnecting or connecting the power cord, after use always wrap the power cord around the cord clips provided.
 - Always replace the fuse in the plug with a British 13amp fuse.
 - Always protect the power cable from heated surfaces or near open flames.
 - Always keep the power cord away from the brushes while in use
 - Use only CE approved 13amp extension cords, non-approved extension cords may overheat. Care should be taken to arrange the extension cord as it can be a trip hazard.
 - Always use the carpet washer with all water/solution tank and filters in place.
 - Keep all openings clear and free from debris as this may affect the airflow/suction.
 - Always use the carpet washer in an upright position. To prevent motor damage from dirty water, never hold the carpet washer upside down or on its side.
 - Store the carpet washer in a cool, dry area. Before storing the carpet washer please ensure all water/solution tanks and filters are thoroughly clean and dry.
- PLEASE KEEP INSTRUCTIONS FOR FURTHER USE.**



HI. WELCOME.

Congrats on purchasing your new Dirt Devil® Carpet Washer. Inside, you'll find everything you want to know from the quick start guide to how to.

So what are you waiting for? LET'S GO.™



PRODUCT REGISTRATION

Be sure to register your product at www.dirtdevil.co.uk

Hint: Attach your sales receipt to this User Guide. Verification of date of purchase may be required for warranty service of your Dirt Devil® product.

For quick reference, please record your product information below.

Model #: _____

Serial number: _____

(Serial number located on the machine's rating label on back or bottom of product)

TABLE OF CONTENTS



Preparing the carpet



1·2·3...

Quick Start Assembly

How to

Fill the water/solution tank

Wash and rinse your carpets

Use Max Extract Function

Use the Power Scrub and upholstery wash tool

Empty the dirty water tank

Clean the base lint filter

Clean the nozzle

Remove blockages from the Power Scrub brushes

Maintain Power Scrub brushes



Trouble Shooting



Limited Guarantee

PREPARING THE CARPET

1. Vacuum carpet thoroughly with a Dirt Devil® vacuum.
2. Place plastic or foil under and around the legs of furniture until the carpet has completely dried.

HELPFUL HINTS FOR CLEANING CARPET

- Plan your route so you don't walk over previously cleaned areas.
- Additional applications may be needed for heavily soiled areas.
- Stay off of the carpet until it is dry.
- Do not oversaturate your carpet with cleaning solution.
- Be sure to rinse carpet thoroughly with water.
- Wipe cleaning solution from wood to prevent damage.



CAUTION

Do not use the carpet cleaner as a dry vacuum.



CAUTION

Do not store the carpet cleaner in garage or area where unit could freeze.

AFTER CLEANING

- Allow carpet to dry completely. Try not to walk on the carpet until it is dry.
- If you need to walk on the carpet, place white towels on the areas you want to walk.
- If the carpet is not dry and the furniture must be placed back in the room, use plastic or foil under the furniture to prevent staining the carpet.



NOTE: Do not transport the carpet cleaner with either the Clean Water Solution Tank or Dirty Water Tank full.

QUICK START

TEST FOR COLOUR FASTNESS

Wet a white absorbent cloth with the solution. In a small hidden area of your carpet/rugs /upholstery gently rub with the dampened cloth. Wait ten minutes and check for colour removal or bleed with white paper towel or cloth. If your carpet has more than one colour, check all colours.

Test your carpet/rugs/upholstery – Run the carpet washer over a small hidden area. If no pile distortion occurs continue cleaning.

IMPORTANT: Your dirty water tank is fitted with a float. When the dirty water tank is full, or the nozzle is not in contact with the carpet the float will shut off the suction on the carpet washer. You will be able to hear if this has happened as the motor noise on the machine will increase. Once the float is activated, empty the dirty water tank if full. If the dirty water tank is not full then turn off your machine at the power switch and wait for the float to settle.

Always unplug the carpet washer before performing any maintenance/ troubleshooting checks.

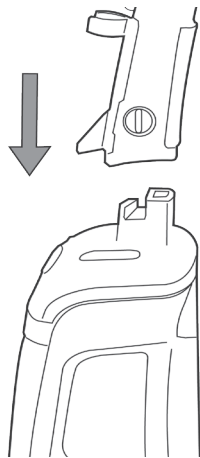

1

Push handle into main body.



2

Turn handle lock dial clockwise to lock in place.

⚠ CAUTION

To reduce the risk of fire, electric shock, or injury: ensure the power cord is out of the way before attaching the upper handle.

⚠ CAUTION

To reduce the risk of damage: Do not use this carpet washer on hard floors. Using this machine on hard floors may scratch or damage your floors.

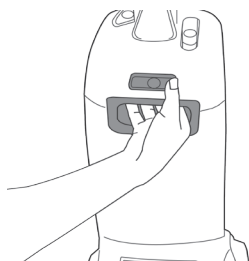

3

Press clean water tank release button.

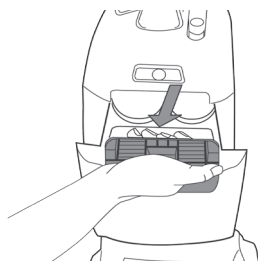

4

Pull to remove clean water tank.

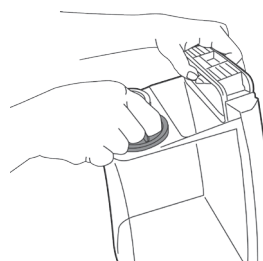

5

Twist clean water tank cap anti clockwise to remove.

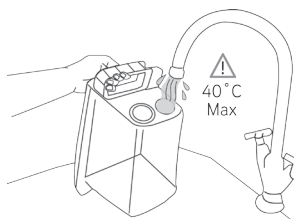

6

Fill clean water tank to 'max' fill mark.

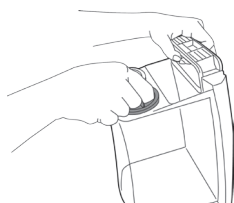

7

Line up tabs on water tank cap with clean water tank, twist clockwise to re-fit.

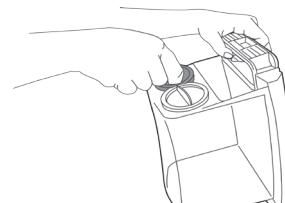

8

Twist solution cap anti-clockwise to remove.

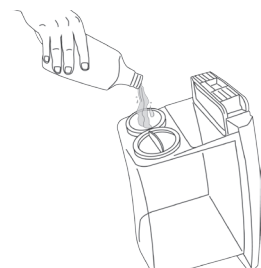

10

Pour required carpet solution into tank.

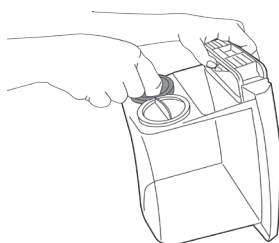

11

Line up tabs on solution cap with clean water tank, twist clockwise to re-fit.



NEED HELP?

Go to www.DirtDevil.co.uk or contact our Customer Service Department at 0330 026 2626 (Mon-Fri 9:00am to 5:00pm).

HOW TO

WASH YOUR CARPETS



CAUTION

Avoid saturating your carpet, do not use more than 4 wet strokes over one area. Always end with dry strokes. For heavily soiled areas, it may be necessary to repeat the cleaning process. Make crisscrossing strokes to the original pattern and overlap each pass.



1. Plug into mains, press the on/off button to switch on.



2. Press the recline pedal and pull handle backwards.



3. Select WASH on the mode selector switch.

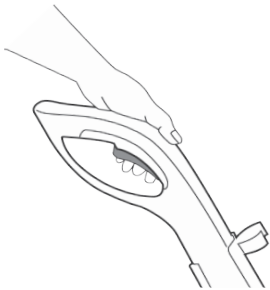

4. Squeeze trigger to release solution and water mix.

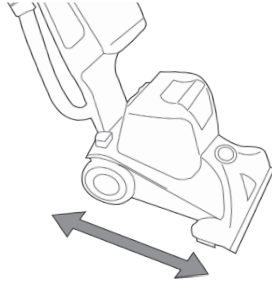

5. Squeeze trigger on the forward stroke, release trigger on backward stroke to recover solution/water.

RINSE YOUR CARPETS

Rinsing is not necessary, but will help remove solution residue leaving your carpets looking fresher.



1. Select RINSE on the mode selector switch.



2. Squeeze trigger to release water.

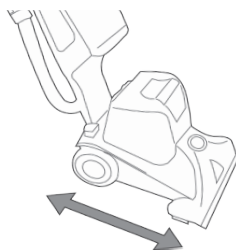

3. Squeeze trigger on forward stroke, release trigger on backward stroke to recover water.

MAX EXTRACT

For superior drying performance use the Max Extract pedal with Max Extract on the mode selector switch. The Power Scrub brushes will not spin when the Max Extract pedal is pressed, the entire power of the carpet washer is used to extract water/solution from your carpets.



1. Select Max Extract on the mode selector switch.

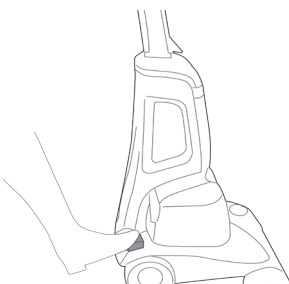

2. Press the Max Extract pedal to activate the Max Extract mode.

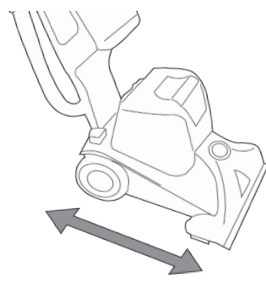

3. The brushes will not spin when the Max Extract pedal is pressed but may turn slowly as the carpet washer is moved forwards/backwards.

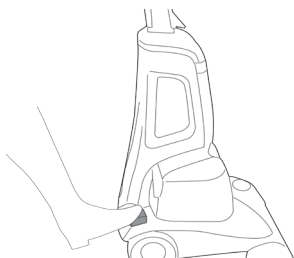

4. Press the Max Extract pedal to de-activate the Max Extract mode.

HOW TO

USE THE POWER SCRUB AND UPHOLSTERY WASH TOOL

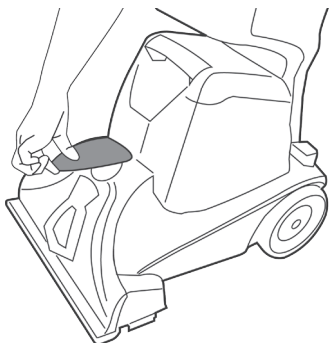

1. Lift cover on hose connection port.

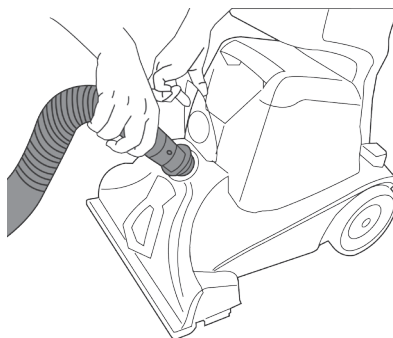

2. Line up tabs on hose into hose connection port. Push and twist hose clockwise to lock into place.

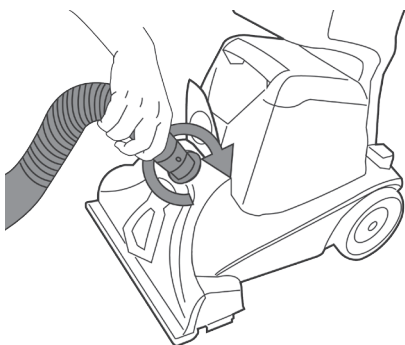

3. Line up solution tube connector with solution tube connection port. Push and twist clockwise to lock into place.

⚠ IMPORTANT: Check the cleaning code on your upholstery. Use the cleaner only on upholstery marked 'W' or 'W/S'. Check with the manufacturer before use. Run the Power Scrub brush and upholstery wash tools over a small hidden area to test before cleaning. When using the hose, select Wash on the mode selector switch. No water/solution will be delivered on Rinse or Max Extract mode.

CHOOSE AN ACCESSORY

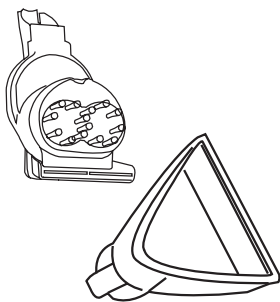

1. Choose an accessory.

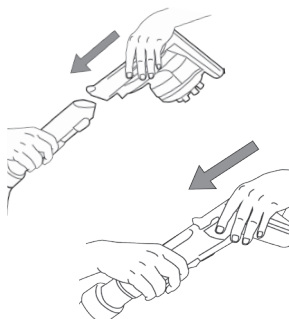

2. Slide accessory tool over tab at end of hose until it clicks into place.



3. Press the on/off button to switch on. Select WASH on mode selector switch (No water/solution will be delivered on RINSE mode).



4. Press trigger on hose to release solution/water.

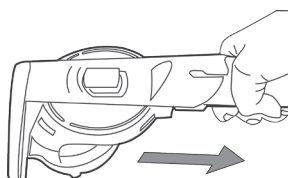

5. Squeeze trigger on the forward stroke, release trigger on backward stroke to recover solution/water.

HOW TO

EMPTY THE DIRTY WATER TANK

CAUTION

Always switch off and unplug the carpet washer from the mains before assembling, filling and emptying the clean water tank, emptying the dirty water tank or before connecting or disconnecting the attachments.

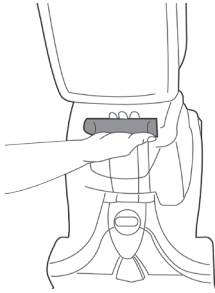

1. Lift dirt water tank by carry handle.

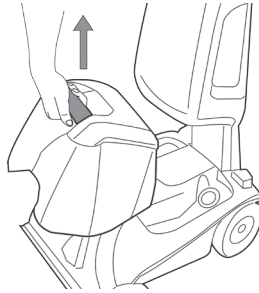

2. Pull to remove dirty water tank.

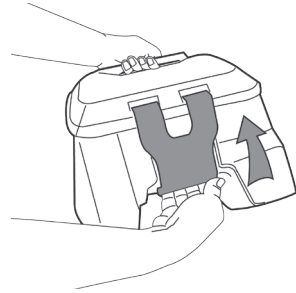

3. Lift dirty water tank clip up and outward to release.

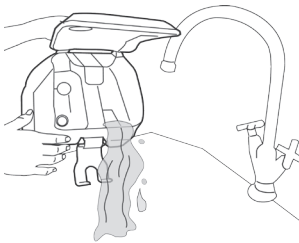

4. Empty dirty water over the sink. Rinse dirty water tank and lid under water to remove debris.

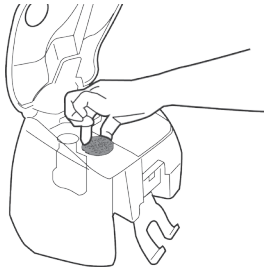

5. Clean the filter screen located at the back of the dirty water tank.

 **IMPORTANT:** If the hose or tools are blocked, switch off the carpet washer and remove the blockage(s) before re-starting your machine.

 **IMPORTANT:** Empty and rinse out clean and dirty water tanks and leave to air dry before replacing. Do not leave solution/water stored in the tanks between uses.

! CAUTION

Always unplug the carpet washer before performing any maintenance/troubleshooting checks. All water and solution must be removed from tanks.

CLEAN THE BASE LINT FILTER

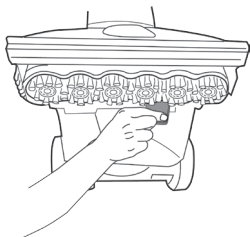

1. Lie carpet washer on its back. The filter is located behind the brushes.

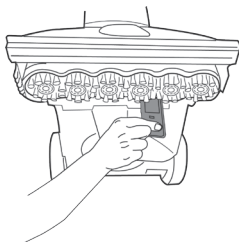

2. Pull filter to remove.

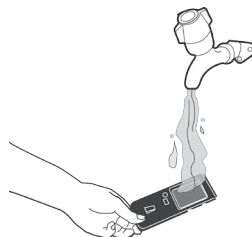

3. Rinse filter under water to remove debris.

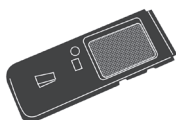
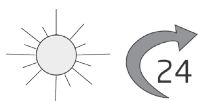

4. Leave to dry for 24 hours or until fully dry before placing back in the carpet washer.

CLEAN THE NOZZLE

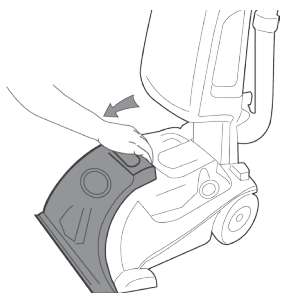

1. Remove dirty water tank. Lift and pull top of nozzle to remove.

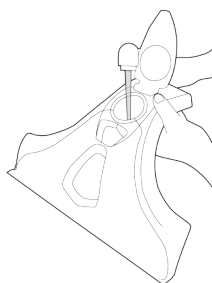

2. Rinse nozzle under water to remove debris.

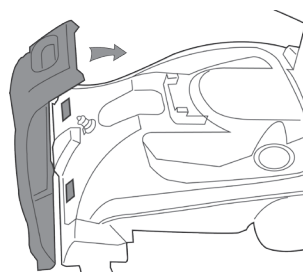

3. Line up tabs on nozzle with holes in carpet washer. Slide tabs into holes, press down on nozzle until clicks into place.

HOW TO

REMOVE BLOCKAGES FROM THE POWER SCRUB BRUSHES

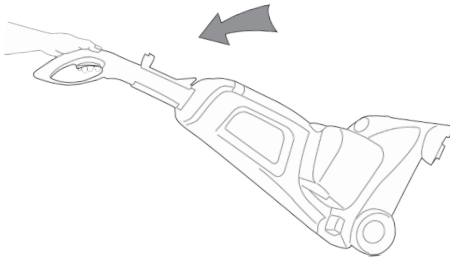

1. Lie carpet washer on its back.

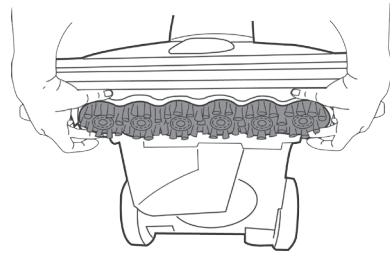

2. Firmly pull sides of Power Scrub cover to remove.

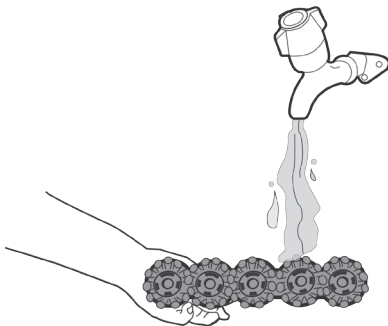

3. Remove any threads or hair caught around the brush, rinse under water to remove debris.

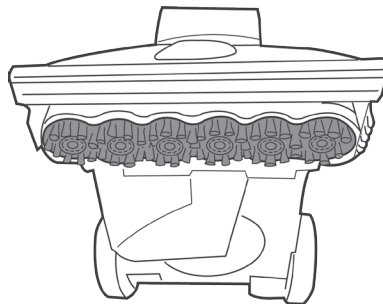

4. Leave to fully dry. Line up tabs on side of Power Scrub cover into carpet washer, push firmly until clicks into place.

MAINTAIN POWER SCRUB BRUSHES

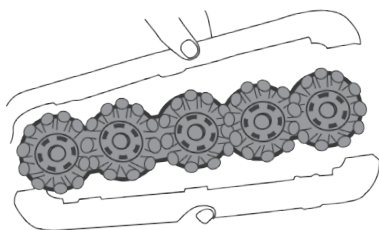

1. Pull firmly to unclip each side of Power Scrub cover (one side at a time).

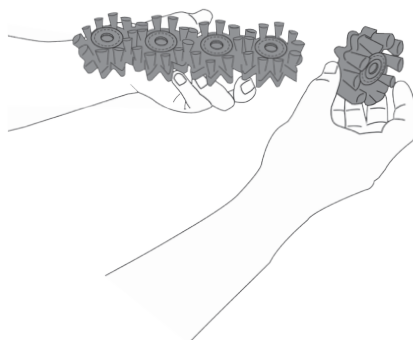

2. Remove individual brushes, clean and rinse under running water to remove debris.

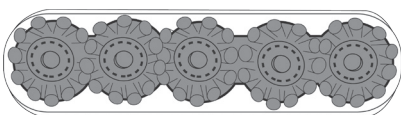

3. Refit the individual brushes. Line up tabs on Power Scrub cover with tabs on brush frame. Push and clip covers until click into place.

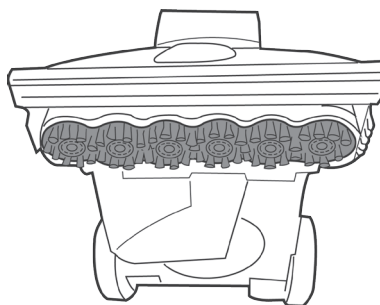

4. Leave to fully dry. Line up tabs on side of Power Scrub cover with carpet washer, push firmly until clicks into place.

TROUBLESHOOTING

If a minor problem occurs, it usually can be solved quite easily when the cause is found by using the checklist below. If not please call the Customer Care Line on 0330 026 2626.

⚠ CAUTION ⚠
TO REDUCE THE RISK OF PERSONAL INJURY - UNPLUG BEFORE CLEANING OR SERVICING.

Problem	Possible Solution
Why won't the carpet washer turn on?	It may not be plugged into the mains correctly: ensure that the plug is pushed in securely and switched on.
	The power button on the carpet washer may not be fully depressed.
	If the carpet washer cuts out during use, disconnect from the electrical socket, allow to cool for one hour, empty the dirty water tank, clean the filter and check hose and Power Scrub brushes for blockages.
Why won't the cleaner pick up solution/spills?	The float in the dirty water tank may have been activated. Empty the dirty water tank if full. If the dirty water tank is not full then switch the carpet washer off and wait for the float to settle before re-starting your machine.
	The dirty water tank may be full and the auto shut off engaged. Empty the dirty water tank.
	Ensure the dirty water tank is fitted correctly and the cover on the hose connection port is closed.
	Check the nozzle is fitted correctly and for blockages.
	Check the Power Scrub brushes for blockages.
	Check the hose for blockages.
Why won't the solution/clean water dispense?	Make sure the clean water tank is fitted securely.
	The solution/clean water tank may be empty.
	Check the carpet washer is on the correct setting no water will be dispensed when using the Max Extract mode.
	No water will be dispensed on 'rinse 'or 'max extract' mode when using the hose.
Why won't the brushes rotate?	The brushes will only rotate when the carpet washer is reclined and turned on.
	Check the lint filter and clean if necessary.
	The brushes will not rotate when set in the Max Extract mode.

GUARANTEE



LIMITED GUARANTEE

It's quick and easy to register for your free 1 year guarantee online at www.dirtdevil.co.uk. Monday-Friday 9am-5pm

Please retain your original receipt for proof of purchase.
Please make a note of the serial number and model number of the product before calling.



**Call our Customer
Service Department at
0330 026 2626**

Monday-Friday 9:00am to 5:00pm.

www.DirtDevil.co.uk

Dirt Devil, 2 Colmore Square, 38 Colmore Circus, Queensway, Birmingham, B4 6BN.



EEC Statement of Compliance: Manufacturer/EEC importer: Vax Limited trading as Dirt Devil, hereby on our own responsibility, declare that the DDW03-E01 series is manufactured in compliance with the following Directives:
Safety: 2006/95/EC Low Voltage Directive. **EMC:** 2004/108/EC Electromagnetic Compatibility Directive



Waste electrical products should not be disposed of with household waste. Please recycle where facilities exist.
Check with your Local Authority or retailer for recycling advice.