

TUMBLE DRYER

EN**English****TVFS 73B****www.hotpoint.co.uk**

 This symbol reminds you to read this instruction manual.

! Keep this manual at hand for immediate reference whenever necessary. Always store this manual close to the tumble dryer and remember to pass it on to any new owners when selling or transferring the appliance, so they may familiarise with the warnings and suggestions herein contained.

! Read these instructions carefully: the following pages contain important information on installation and useful suggestions for operating the appliance.

Contents

Installation, 2

Where to install the tumble dryer
Ventilation
Electrical connections
Levelling the tumble dryer
Before you start your dryer

Warnings, 4

General safety
Saving energy and respecting the environment

Care and maintenance, 6

Disconnecting the power supply
Cleaning the filter after each cycle
Checking the drum after each cycle
Cleaning the tumble dryer

Description of the tumble dryer, 7

Features
Control panel

How to carry out a drying cycle, 10

Starting and selecting a programme

Programmes and options, 11-12-13

Programme chart
Special programmes
Options
Opening the door

Laundry, 14

Sorting laundry
Care labels
Drying times

Troubleshooting, 15

Assistance and Guarantee, 16

Spare parts
Information on recycling and disposal

GB

To activate you free* 5 years parts guarantee

Call free on 0800 519 2102

*Labour charges not included. Terms and conditions apply. Lines open 364 days a year.
Calls are free from a BT landline. Charges from other providers and mobiles may apply.

Installation

GB

Where to install the tumble dryer

• Install the dryer far from gas ranges, stoves, radiators or hobs, as flames may damage it. If the dryer is installed below a worktop, ensure there are 10 mm between the upper panel of the dryer and any objects above it, and 15 mm between the sides of the machine and the walls or furniture units adjacent to it. This ensures adequate air circulation. Make sure the air inlets on the rear panel are not blocked or obstructed.

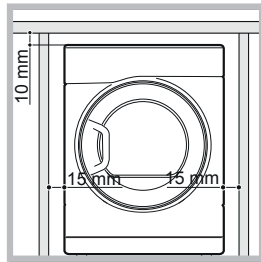

- You should also make sure that the room in which the tumble dryer is installed is not damp, and that it is adequately ventilated.
- **!** We do not recommend that the dryer is installed in a cupboard but the dryer must never be installed behind a lockable door, a sliding door or a door with a hinge on the opposite side to that of the dryer door.
- **!** The appliance must be installed with the rear surface placed against a wall.

Ventilation

This appliance gently dries laundry by taking in cold, clean and relatively dry air, heating it and passing it through the fabric. To facilitate the drying process, damp air is expelled at the rear, through a ventilation hose. When the dryer is in use, there has to be adequate ventilation to avoid a back flow of gases into the room from appliances burning other fuels, including open fires.

Mobile ventilation system

When using the tumble dryer with the mobile ventilation system, a ventilation hose must be connected. The hose should be securely fastened to the ventilation hole at the rear of the appliance (see "Description of the tumble dryer"). We recommend the hose is connected to an outlet near the tumble dryer, if possible. If it cannot be installed in a permanent spot, the tumble dryer will still function perfectly well if the ventilation hose is passed through a partially-opened window.

! Make sure you do not point the ventilation hose towards the air inlet, which is located on the rear of the appliance.

! The ventilation hose should not exceed a maximum length of 2.4 metres; it should also be shaken frequently to remove any fluff, dust or water deposits inside it. Make sure you do not crush the hose.

Fixed ventilation system

We recommend the ventilation hose is connected to a ventilation system for windows or doors, available from the retailer which originally sold you the appliance or from your local spare parts stockist.

Wall ventilation hole

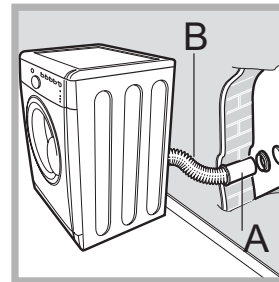

1. Leave an opening in the wall to the left of the tumble dryer installation site.
2. Make the hose as short and straight as possible, in order to prevent any moisture from condensing and leaking back into the appliance.
3. The hole in the wall must also be straight and pointing

downwards, so that the flow of air coming out is not impeded.

Areas **A** and **B** should be checked frequently, to prevent the accumulation of fluff or debris, particularly if the tumble dryer is used very often. The hose adaptor must be fitted correctly, in order to prevent damp air from coming back into the room.

Window ventilation hole

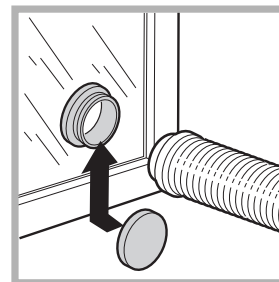

The ventilation hole should be directly behind the dryer in order to keep the hose as short as possible.

! Make sure you do not push the tumble dryer too far backwards, as this could lead to the ventilation hose being crushed, bent or even disconnected.

! There should be no cuts, kinks or "U"-shaped bends in the hose, as these could impede ventilation or trap condensation.

Ventilation through an open window

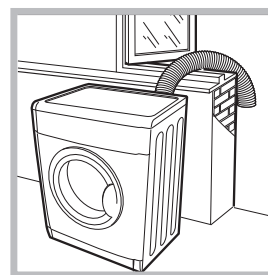

The end of the hose must be facing downwards, in order to prevent the hot, damp air from forming condensation in the room or the tumble dryer.

! Make sure that the tumble dryer is adequately ventilated, and that the end of the ventilation hose is not pointing towards the air inlet pipe on the rear of the appliance.

! The ventilation hose must always be fitted to ensure optimum performance.

! Make sure that the ventilation hose and the air inlet vents are not obstructed or blocked.

! Do not let the tumble dryer recirculate exhaust air.

! Improper use of the tumble dryer may result in fire hazards.

! The air emitted by the tumble dryer must not be expelled in the same duct as used for the fumes produced by different appliances which burn gas or other fuels.

! Do not discharge the exhaust air into an extraction system or any duct with an extractor fan. This will affect the way the thermal controls operate and can result in a fire hazard.

Electrical connections

Before plugging the appliance into the socket, check the following:

- Make sure your hands are dry.
- The socket must have an earth connection.
- The socket must be able to withstand the machine's maximum power output as indicated on the rating plate (see *Description of the tumble dryer*).
- The power supply voltage must fall within the values indicated on the rating plate (see *Description of the tumble dryer*).
- The socket must be compatible with the dryer's plug. Should this not be the case, replace the plug or the socket.

! DO NOT USE EXTENSION CORDS.
(MAIUSCOLO)

! The dryer must not be installed outdoors, even if the space is sheltered. It can be very dangerous if exposed to rain or storms.

! Once installed, the dryer's electrical wire and plug must be within reach.

! The power cord must not be bent or squashed.

! If the plug being replaced is a non-rewirable type, then the cut-off plug must be disposed of safely. DO NOT leave it where it can be inserted into a socket and create a shock hazard.

! The electric cord must be regularly checked. If the supply cord is damaged, it must be replaced by the manufacturer, its service agent or similarly qualified persons in order to avoid a hazard. (see *Service*). New or longer power cords are supplied at an extra charge by authorized dealers.

! The manufacturer denies any responsibility should any of these rules not be followed.

! If in doubt about any of the above consult a qualified electrician.

Levelling the tumble dryer

The tumble dryer should be installed level in order to operate correctly.

After installing the tumble dryer in its permanent position, make sure it is level; check its side-to-side levelling first, followed by front-to-back.

If the tumble dryer is not perfectly level, use a wooden block to support it while you adjust the two front feet, up or down as necessary.

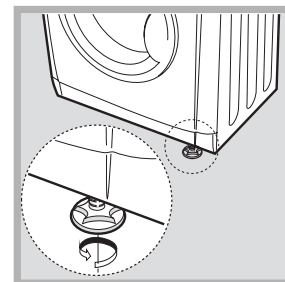
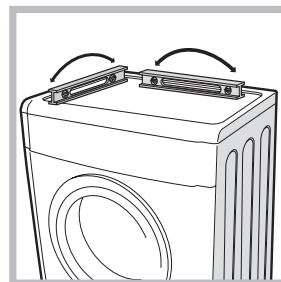

Before you start your dryer

Once the tumble dryer is installed, clean the inside of the drum before operating it and remove any dirt accumulated during transportation.

Warnings

GB

! This appliance has been designed and built according to international safety standards. These warnings are given for safety reasons and must be followed carefully.

General safety

- This appliance can be used by children aged from 8 years and above and persons with reduced physical, sensory or mental capabilities or lack of experience and knowledge if they have been given supervision or instruction concerning use of the appliance in a safe way and understand the hazards involved.
- This tumble dryer has been designed for home, and not professional, use.
- Do not touch the appliance while barefoot or with wet hands or feet.
- Unplug the machine by pulling on the plug, not the cord.
- Children should be supervised to ensure that they do not play with the dryer.
- Cleaning and user maintenance shall not be made by children without supervision.
- Children of less than 3 years should be kept away from the appliance unless continuously supervised.
- The appliance must be installed correctly and have proper ventilation. The air intake vents behind the machine, the outlet vents and the vent tube should never be obstructed (see Installation).
- Never direct the vent tube outlet towards the air intake at the back of the machine.
- Never allow the tumble dryer to recycle exhaust air.
- Never use the dryer on carpeting where the pile height would prevent air from entering the dryer from the base.
- Check to see if the dryer is empty before loading it.
-  The back of the dryer could become very hot. Never touch it while in use.
- Do not use the dryer unless the filter, is securely in place (see Maintenance).
- Do not overload the dryer (see Laundry for maximum loads).
- Do not load items that are dripping wet.
- Carefully check all instructions on clothing labels (see Laundry).
- Do not tumble dry large, very bulky items.
- Do not tumble dry acrylic fibres at high temperatures.
- Do not turn off the dryer when there are still

warm items inside.

- Clean the filter after each use (see Maintenance).
- Do not allow lint to collect around the dryer.
- Never climb on top of the dryer. It could result in damage.
- Always follow electrical standards and requirements (see Installation).
- Always buy original spare parts and accessories (see Service).

To minimise the risk of fire in your tumble dryer, the following should be observed:

- Tumble dry items only if they have been washed with detergent and water, rinsed and been through the spin cycle. It is a fire hazard to dry items that HAVE NOT been washed with water.
- Do not dry garments that have been treated with chemical products.
- Do not tumble dry items that have been spotted or soaked with vegetable or cooking oils, this constitutes a fire hazard. Oil-affected items can ignite spontaneously, especially when exposed to heat sources such as a tumble dryer. The items become warm, causing an oxidation reaction with the oil. Oxidation creates heat. If the heat cannot escape, items can become hot enough to catch fire. Piling, stacking or storing oil-affected items can prevent heat from escaping and so create a fire hazard. If it is unavoidable that fabrics containing vegetable or cooking oil or those that have been contaminated with hair care products be placed in a tumble dryer they should first be washed with extra detergent - this will reduce, but not eliminate the hazard. They should not be removed from the dryer and piled or stacked while hot.
- Do not tumble dry items that have previously been cleaned in or washed in, soaked in or soiled with petrol/gasoline, dry cleaning solvents or other flammable or explosive substances. Highly flammable substances commonly used in domestic environments including cooking oil, acetone, denatured alcohol, kerosene, spot removers, turpentine, waxes and wax removers. Ensure these items have been washed in hot water with an extra amount of detergent before being dried in the tumble dryer.
- Do not tumble dry items containing foam

rubber (also known as latex foam), or similarly textured rubber like materials. Foam rubber materials can, when heated, produce fire by spontaneous combustion.

- Fabric softener or similar products should not be used in a tumble dryer to eliminate the effects of static electricity unless the practice is specifically recommended by the manufacturer of the fabric softener product.
- Do not tumble dry undergarments that contain metal reinforcements eg. bras with metal reinforcing wires. Damage to the tumble dryer can result if the metal reinforcements come loose during drying.
- Do not tumble dry rubber, plastic articles such as shower caps or babies waterproof covers, polythene or paper.
- Do not tumble dry rubber backed articles, clothes fitted with foam rubber pads, pillows, galoshes and rubber coated tennis shoes.
- Remove all objects from pockets such as lighters and matches.

WARNING: Never stop the dryer before the end of the drying cycle unless all items are quickly removed and spread out so that the heat is dissipated.

Save energy and respect the environment

- Wring out all items to eliminate excess water before tumble drying (if you use a washing machine first, select a high spin cycle). Doing this will save time and energy during drying.
- Always dry full loads - you save energy: single items or small loads take longer to dry.
- Clean the filter after each use to contain energy consumption costs (see *Maintenance*).

Maximum load sizes: 7 kg

Product Data - Regulation 392/2012.	
Brand	Hotpoint
Model	TVFS 73B GP (UK) TVFS 73B GG (UK) TVFS 73B GK (UK) TVFS 73B GX (UK)
Rated capacity of cotton laundry for the "standard cotton programme" at full load - kg	7.0
This household tumble drier is a	Vented
Energy efficiency class on a scale from A+++ (low consumption) to D (high consumption)	B
The weighted Annual Energy Consumption (AEC)* kWh 1)	444.5
This household tumble drier is a	Automatic
Energy consumption full load; E _{dry} - kWh 2)	3.77
Energy consumption partial load; E _{dry} ^{1/2} - kWh 2)	2.02
Power consumption: off-mode (P _o) - Watts	0.14
Power consumption: left-on mode (P _l) - Watts	1.96
Duration of the 'left-on mode' for power management system - minutes	30
Prog. Time - weighted (T _t) full & partial load - minutes 3)	78
Full load (T _{dry}) - minutes	103
Partial load (T _{dry} ^{1/2}) - minutes	59
Condensation efficiency class on a scale from G (least efficient) to A (most efficient)	N/A
Average condensation efficiency - %	
weighted (C _t) full & partial load 3)	
full load (C _{dry})	
partial load (C _{dry} ^{1/2})	
Airborne acoustical noise emissions - dB(A) re 1 pW	69.0
1) The "standard cotton" at full and partial load are the standard programmes to which the information in the label and the fiche relates. The standard cotton program is suitable to dry at cupboard level (0%) cotton laundry and is the most efficient programme in terms of energy consumption. Partial load is half the rated load.	
2) based on 160 drying cycles of the standard cotton programme at full and partial load, and the consumption of the low-power modes. Actual energy consumption will depend on how the appliance is used.	
3) Weighted average of 3 cycles at full load and 4 cycles at half load.	
Regulation 932/2012.	
Energy consumption in kWh, for program "Synthetics" full load	0.0
Programme time in minute, for program "Synthetics" full load	0
Partial load for program "Synthetics" N/A	

Care and maintenance

GB

Disconnecting the power supply

! Disconnect the dryer when not in use or during cleaning and maintenance operations.

Cleaning the filter after each cycle

The filter is a fundamental component of the dryer: its function is to collect lint and fluff that form during drying.

Clean the filter once drying is completed, by rinsing it under running water or cleaning it with a vacuum cleaner. Should the filter become clogged, the flow of air inside the dryer will be seriously hampered: drying times become longer and more energy is consumed. Moreover, the dryer may become damaged.

- Periodically check the vent hose and all other parts of the venting system and remove any accumulations of fluff and lint.

! Do not use solvents or abrasives.

! Have the dryer checked regularly by authorised technical personnel in order to ensure that the electrical and mechanical parts work safely (see *Assistance*).

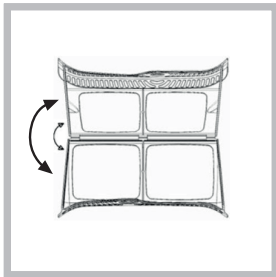

The filter is located behind of the dryer seal (see *Picture*).

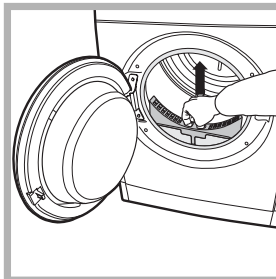

Removing the filter:

1. Pull the filter's plastic handle upwards (see *Picture*).
2. Clean the fluff off the filter and replace it correctly. Ensure that the filter is pushed fully home.

! Do not use the dryer unless the filter has been replaced in its holder.

Checking the drum after each cycle

Rotate the drum manually to remove smaller items (handkerchiefs) that could have been left inside the dryer.

Cleaning the drum

! Avoid using abrasives, steel wool or stainless steel cleaning agents to clean the drum.

A coloured film may appear on the stainless steel drum surface: it may be caused by a combination of water and/or cleaning agents such as fabric conditioners. This coloured film does not affect the dryer's performance.

Cleaning the tumble dryer

- The external metal and plastic parts and the rubber parts can be cleaned with the aid of a damp cloth.

Description of the tumble dryer

Front side

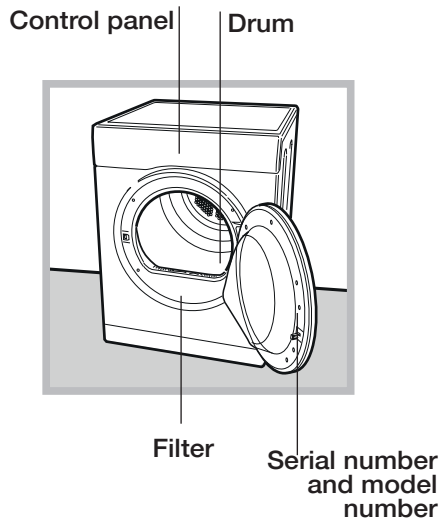

Rear side

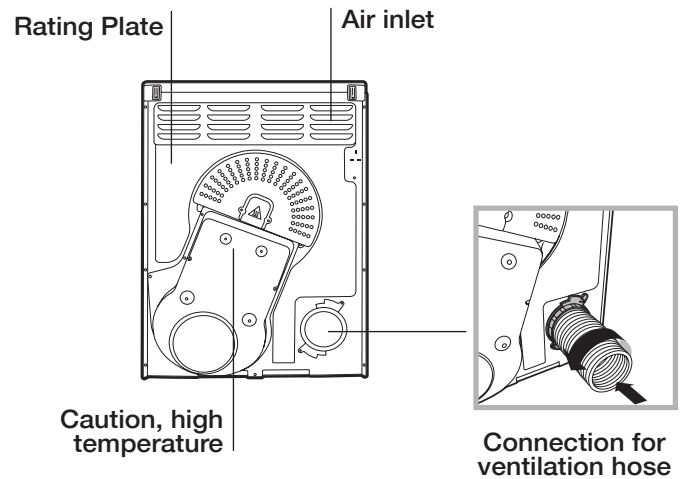

GB

Control panel

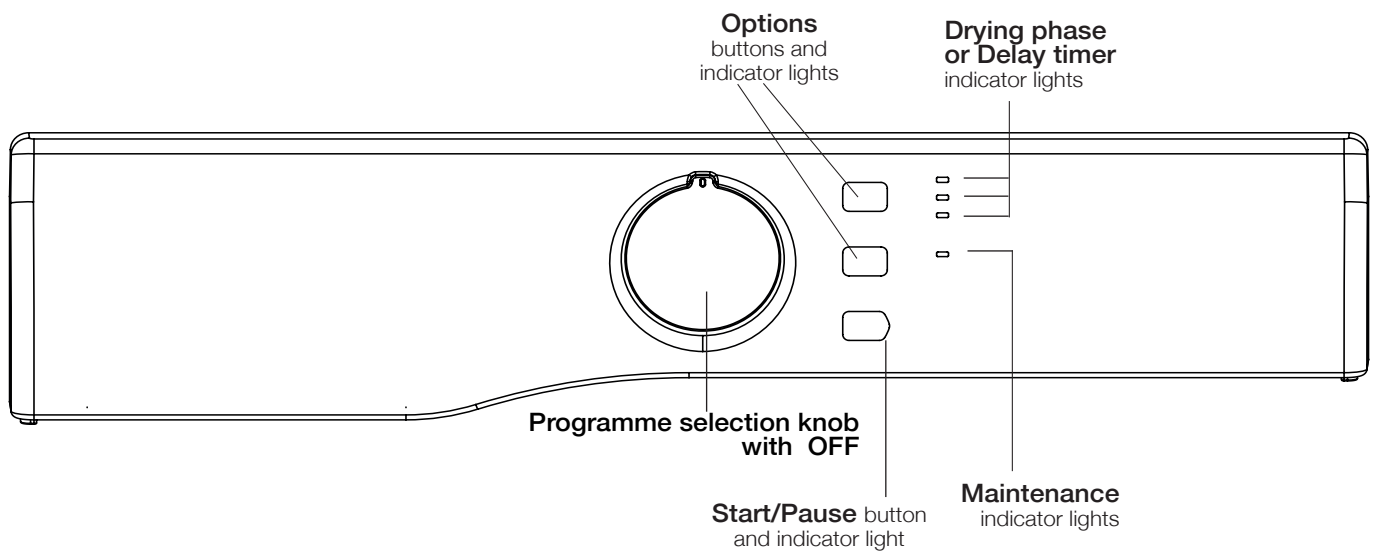

Programme selection knob

Allows for setting the programme: turn until the indicator points towards the desired programme. The OFF position switches off the dryer (see *Starting and selecting a programme*).

Options buttons

Allow for selecting the options available for the selected programme. The relative indicator lights turn on when the option has been selected (see *Programmes and options*).

START/PAUSE button and indicator light

When the green light flashes slowly, press the button to start the programme. When the cycle is under way, the indicator light remains on. To put the programme into pause mode, press the button again; the indicator light will turn orange and start flashing again. To resume the programme from the point it was interrupted, press the button again (see *Start and programme selection*).

Indicator lights

The indicator lights provide important information. They indicate the following:

“Clean filter” indicator light

Before each programme, the “Clean filter” indicator light  signals that it is essential to clean the filter each time before using the tumble dryer (see *Care and maintenance*).

“Drying phases” indicator lights

The  **DRYING** indicator light signals that the drying phase is running.

The  **COOL TUMBLE** indicator light signals that the cooling phase is running.

The **END** indicator light signals that the programme has ended.

“Delay start” indicator light

If the “Delay start” option has been activated (see *“Programmes and options”*), after the programme has started, the indicator light corresponding to the chosen delay time will start flashing:

As time passes, the remaining delay will be displayed and the corresponding indicator light will flash:

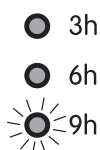

Once the set delay time ends, the flashing LED will turn off and the set programme will start.

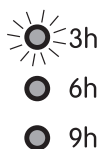

How to carry out a drying cycle

Starting and selecting a programme

1. Plug the dryer into the power supply socket.
 2. Select the programme according to the type of laundry (see *Laundry*).
 3. Open the door, ensure that the filter is clean and securely placed (see *Care and maintenance*).
 4. Load the machine, making sure that no piece of laundry gets between the door and the relative seal. Close the door.
 5. After consulting the programme chart and the indications for each type of fabric (see *Laundry*), turn the Programme selection knob towards the programme corresponding to the type of laundry to be dried (see *Programmes and options*).
! Warning: If the position of the programme selection knob changes after pressing the START/PAUSE button, the selected programme will NOT be modified. To modify the programme, press the START/PAUSE button to put the programme in pause mode (the indicator light flashes orange), then select a new programme and the relative options. Press the START/PAUSE button to start the new programme.
 6. If necessary, set the time of the delayed start and any other options (see *Programmes and options*).
 7. Press the START/PAUSE button to start the drying cycle.
Laundry can be checked while the drying programme runs and any garments already dry can be removed, while drying continues for the remaining items. After closing the door, press the START/PAUSE button to resume machine operation.
 8. The final COOL TUMBLE phase (i.e. the fabrics are cooled) activates during the last few minutes of the drying programme; always allow this phase to terminate.
 9. When the **END** indicator light turns on, the programme has ended. The buzzer will beep 3 times to let you know that your programme is complete. Open the door, remove the laundry then clean the filter and replace it (see *Care and maintenance*).
- If the clothes are not removed at the end of the cycle the automatic **POST CREASE CARE** action will, on those programmes with this feature, continue to rotate the drum intermittently for up to 10 hours to minimise creasing. The phase is stopped when the door is opened or when the knob is set to OFF
10. Set the program knob to OFF to switch off the machine.
 11. Disconnect the dryer from the power supply.

Automatic pre-post Anti Crease

This is an automatic function which provides an anti crease treatment both before and after the drying programme. By periodically rotating the drum before the start of the drying cycle, when a delayed start is selected, the formation of creases is prevented. On certain programmes the drum also rotates periodically at the end of the drying cycle on. The phase is stopped when the door is opened or when the knob is set to OFF

Stand-by mode

This tumble dryer, in compliance with new energy saving regulations, is fitted with an automatic standby system which is enabled after about 30 minutes if no activity is detected.

Turn the knob to the desired program to restart dryer operation (to start the program press START/PAUSE). The OFF position switches off the dryer.

Programmes and options

GB

Programme chart

	Programme	Max. load (kg)	Compatible options	Cycle duration*
Cottons				
1	Ready to Wear	max	Delay timer	120'
2	Standard Cotton	max	Delay timer - Fibre Care	110'
3	Easy Iron	max	Delay timer - Fibre Care	120'
Delicates				
4	Synthetics	4	Delay timer	60'
5	Synthetics Easy Iron	4	Delay timer	40'
6	Silk	0.5	-	30'
Esclusive Care				
7	Bed & Bath	max	Delay timer	140'
8	Shirts	3	Delay timer - Fibre Care	80'
9	Jeans	3	Delay timer	75'
10	Baby Cycle	2	Delay timer	50'
Timed drying				
	15' - 40' - 60' - 90' minutes.	-	Delay timer - Fibre Care	
Extra				
	Refresh	-	-	20'

* **note:** The duration of these programs will depend on the size of the load, types of textiles, the spin speed used in your washer and any extra options selected.

Special Programmes

Cottons

Ready to Wear: Dries your items to the maximum possible dryness level. Even drier than Standard Cotton dry.

Standard Cotton: Dries your items to a dryness level that allows you to put your clothes away straight from the dryer.

Easy Iron: Dries your items to a dryness level that allows them to minimise ironing.

Synthetics

Recommended to delicately dry synthetic fabrics.

Synthetics Easy Iron

This is a programme for items of Synthetic or Synthetic/Cotton mixtures, with a level of dryness that minimizes ironing.

Silk

This is a programme for drying your delicate silk. Loads dried using this programme are usually ready to use, but on some heavier garments the edges may be slightly damp. If this is the case, remove the load and open them out and then run the programme again for a short period.

Bed & Bath

- This is a programme for Cotton Towels and sheets.
- Loads dried using this programme are usually ready to use; the edges or seams may be slightly damp especially on large items. If this is found try opening them out and running the programme again for a short period.

Shirts

This is a programme for shirts made from cotton. It can be used for load sizes up to 3kg (approximately 10 shirts).

Shirts and Fibre Care option

This is a programme for shirts made from synthetic materials or a mixture of natural and synthetic materials, such as polyester and cotton. It can be used for load sizes up to 3kg (approximately 14 shirts).

Loads dried using this program are usually ready to wear, the edges or seams may be slightly damp. If this is the case, try turning the shirts inside out and running the programme again for a short period.

Jeans

This is a programme for jeans made from denim cotton. Before drying your jeans turn the front pockets inside out. Do not mix dark and light coloured items.

It can also be used on other garments made from the same material, such as jackets.

Loads dried using this programme are usually ready to wear, the edges or seams may be slightly damp. If this is the case, try turning the jeans inside out and running the programme again for a short period.

! We do not recommend that you use this programme if your jeans have elastic waist bands, studs or embroidery.

Baby Programme

This is a programme for drying your baby's small delicate items of clothing and bedding (Cotton and Chenille) and for drying your delicate clothes.

DO NOT dry items such as bibs and nappy pants with plastic coverings.

It can be used for load sizes up to 2kg.

Loads dried using this programme are usually ready to wear, but on some heavier garments the edges may be slightly damp. If this is the case, try turning items inside out and running the programme again for a short period.

Timed drying cycle (15' - 40' - 60' - 90")

These programmes can be used if you want to set drying time and temperature.

The COOL TUMBLE cycle runs during the final minutes of the programme.

15' timed programme is ideal to remove damp from tea towels and bathrobe used once.

40': this is a quick timed programme, ideal for drying garments spun at high speed in the washing machine, for example shirts used in a work week.

60': a timed programme, ideal for drying garments spun at high speed in the washing machine, for example a change of sheets.

90': timed programme is ideal for drying more quantity of garments (see below table)

Refresh

A short programme suitable for refreshing fibres and garments. It lasts about **20** minutes.

! As this is not a drying programme, it is not to be used for garments that are still wet.

It can be used on any load size but is more effective on smaller loads.

Fabric	Load				
	1 kg	2 kg	3 kg	4 - 5 kg	6 kg
Cotton –	40 minutes	40 or 60 minutes	60 or 90 minutes	90 minutes	-
Synthetics – 4kg	40 or 60 minutes	40 or 60 minutes	40 or 60 minutes	60 or 90 minutes	-
Acrylics – fibre care	40 minutes	60 minutes	-	-	-

Options

The options allow for customising the selected programme according to one's own needs.

Delay timer

The start of some programmes (see *Programmes and options*) may be delayed up to 9 hours. Press the button repeatedly to enter the desired delay time. Before setting a delayed start, make sure that the filter is clean. The drum will rotate occasionally before the drying programme starts to prevent the formation of creases.

Fibre care

Fibre Care is a special option designed to gently dry delicate clothes.

Press this button to select the low temperature setting; the light next to the button will switch on. Activating this option will increase the duration of the cycles.

Key Lock

Prevents the program settings from being changed. After having selected the program and the available options, hold down the two option buttons for 3 seconds (see "Dryer description")

A prolonged beep will sound when the buttons are pressed and the LEDs on the options buttons will flash slowly twice. The LEDs on the previously selected options will then remain lit but will no longer be modifiable.

If you attempt to change the settings with KEY LOCK activated, 3 short beeps will sound and 3 rapid flashes will warn you that it is not possible to modify the program or the options underway.

Hold down the options buttons for three seconds to deactivate the KEY LOCK option. KEY LOCK can be selected with all programs.

The OFF position switches off the dryer.

! Not all options are available on all programmes (see *Programmes and options*).

Opening the door

If the door is opened (or the START/PAUSE button is pressed) while a programme is running, the dryer stops and the following may occur:

- The START/PAUSE button flashes orange.
- When a delayed start is running, the delay countdown continues. It is necessary to press the START/PAUSE button to resume the "Delay timer" programme. One of the "Delay timer" indicator light flashes to signal the delay time entered.
- It is necessary to press the START/PAUSE button to resume the programme. The progress indicator lights signal the running phase and the START/PAUSE indicator light stops flashing and turns green.
- When post care phase is active it means that drying programme is already ended. Pressing the START/PAUSE button reactivates a new programme from the beginning.
- By turning the Programme selection knob, a new programme is selected and the START/PAUSE indicator light flashes green. This procedure can be used to select the COOL TUMBLE programme to cool garments if they are judged to be dry enough. Press the START/PAUSE button to start the new programme.

Note: If you have a power cut, switch off the power or remove the plug. When power is restored, plug in the machine. Turn the knob to the desired program to restart dryer operation (to start the program press START/PAUSE). The OFF position switches off the dryer.

Sorting laundry

- Check the symbols on the care labels of the various garments to verify whether the garments can be safely tumble dried.
- Sort laundry according to the type of fabric.
- Empty all pockets and check for loose buttons.
- Close zips and hooks and fasten belts and strings without tightening them.
- Wring out garments to remove the maximum amount of water possible.

! Do not load the dryer when garments are dripping wet.

Maximum load sizes

Do not overload the drum.

The following values indicate the weight of dry garments:

Natural fibres: maximum 7 kg

Synthetic fibres: maximum 4 kg

! Do not overload the dryer as this may result in reduced drying performance.

Care labels

Always check the care labels, especially when placing garments in the tumble dryer for the first time. Below are the most commonly used symbols:

- May be tumble dried.
- Do not tumble dry.
- Tumble dry – high heat.
- Tumble dry – low heat.

Drying times

Drying times are approximate and may vary depending on the following:

- Amount of water retained by items after the spin cycle: towels and delicate items retain a lot of water.
- Fabrics: items of the same fabric, but with different texture and thickness may have different drying times.
- Amount of laundry: single items and small loads may take longer to dry.
- Drying: if items are to be ironed, they can be removed from the dryer while still slightly damp. Items that require complete drying can be left longer.
- Heat setting.
- Temperature of the room: the lower the temperature of the room, the longer it will take for the dryer to dry clothing.
- Bulk: certain bulky items require special care during the drying process. We suggest removing these items and replacing them in the dryer once they have been shaken out: repeat this procedure several times during the course of the drying cycle.

! Do not over-dry items.

All fabrics contain natural dampness which helps to keep them soft and fluffy.

The drying times provided refer to the automatic Cupboard dry programmes.

The Timed drying settings are also indicated to enable you to select the most suitable timed option.

The weight refers to dry items.

Automatic drying times

Cotton						
Drying times after 800-1000 rpm wash cycles - with an initial humidity level of 60%						
1 kg	2 kg	3 kg	4 kg	5 kg	6 kg	7 kg
20 - 30 minutes	35 - 45 minutes	45 - 60 minutes	60 - 70 minutes	70 - 80 minutes	80 - 100 minutes	90 - 120 minutes
Synthetics Fibre Care						
Drying times after wash cycles at lower speeds - with an initial humidity level of 40%						
1 kg	2 kg	3 kg	4 kg			
20 - 30 minutes	35 - 45 minutes	45 - 60 minutes	60 - 80 minutes			
Acrylics Fibre Care						
Drying times after wash cycles at lower speeds - with an initial humidity level of 40%						
1 kg			2 kg			
50 - 70 minutes			90 - 130 minutes			

Troubleshooting

GB

If you feel that the dryer is not working properly, consult the following troubleshooting suggestions before contacting the Technical Assistance Centre (see *Assistance*).

Problem:

Possible causes / Solutions:

The dryer does not start.

- The plug has not been inserted far enough into the socket to make contact.
- There has been a power cut.
- The the fuse has blown. Try connecting another appliance to the same socket.
- If an extension cord is used, try connecting the dryer plug directly into the socket.
- The door has not been closed properly.
- The programme has not been set correctly (see *How to carry out a drying cycle*).
- The START/PAUSE button has not been pressed (see *How to carry out a drying cycle*).

The drying cycle does not start.

- A delayed start time has been set (see *Programmes and options*).
- The START/PAUSE button has been pressed; a short delay follows before the dryer starts running. Wait for the drying cycle to start; do not press the START/PAUSE button otherwise the dryer switches to the pause mode and the drying cycle will not start.

Drying times are too long.

- The filter has not been cleaned (see *Care and maintenance*).
- The heat setting is not suited to the type of fabric to be dried (see *Programmes and options*).
- An incorrect drying time was selected for the type of load (see *Laundry*).
- The flexible ventilation hose may be blocked (see *Installation*).
- The air inlet may be blocked or obstructed (see *Installation*).
- The fixed ventilation flap, on the protective weatherproof cover, may be obstructed (see *Installation*).
- The items are too wet (see *Laundry*).
- The dryer is overloaded (see *Laundry*).

The programme is finished but the items are damper than expected.

- ! For safety reasons, the dryer programmes last a maximum of 4 hours. If an automatic programme has not detected the final dampness level required in this interval, the dryer completes the programme and stops. Check the above points and repeat the programme; if the items are still damp, contact the Technical Assistance Centre (see *Assistance*).

The dryer is noisy during the first few minutes of operation.

- This is normal, especially if the dryer has not been used for a long time. If the noise persists during the entire cycle, contact the Technical Assistance Centre.

The lights on the dryer control panel are off although the dryer is switched on.

- The dryer has gone into standby mode to save power. This occurs if you have left the dryer on or have had a power cut. It occurs after 30 minutes:
 - if you leave the dryer without starting a programme;
 - after your drying programme has finished.Turn the knob to the desired program to restart dryer operation (to start the program press **START/PAUSE**). The **OFF** position switches off the dryer.

Before contacting the Technical Assistance Centre:

- Follow the troubleshooting guide to check whether problems can be solved personally (see *Troubleshooting*).
- If not, switch the dryer off and contact the Technical Assistance Centre closest to you.

Provide the following data when contacting the Technical Assistance Centre:

- name, address and postal code
- telephone number
- type of malfunction
- date of purchase
- the appliance model (Mod.)
- the dryer's serial number (S/N)

This information can be found on the data plate located behind the door.

Spare parts

This dryer is a complex machine. Attempting to repair it personally or with the aid of an unqualified personnel may put the safety of people at risk, damage the machine or invalidate the spare parts guarantee. Always contact a qualified technician when experiencing problems with this machine.

GB

Information on recycling and disposal

As part of our continual commitment towards environmental protection, we reserve the right to use recycled quality components to reduce costs for our customers and to minimise materials wastage.

- Disposing of the packaging materials: follow local regulations to allow for recycling of packaging materials.
- In order to minimise the risk of injury to children, remove the door and plug, then cut the power supply cord flush with the appliance. Dispose of these parts separately to prevent the appliance from being connected to a power supply socket.

Disposal of old household appliances



European Directive 2012/19/EC concerning Waste Electrical and Electronic Equipment (WEEE) states that household appliances should not be disposed of using the normal solid urban waste cycle. Exhausted appliances should be collected separately in order to optimise the cost of re-using and recycling materials comprising the machine, while preventing potential damage to public health and the environment. The crossed-out wheeled bin symbol appears on all products to remind owners of the obligations regarding separate waste collection.

Owners should contact their local authorities or appliance dealers for further information concerning the correct disposal of household appliances.



This appliance conforms to the following EU directives:

- 2006/95/EC (Low Voltage Directive)
- 2004/108/EC (Electromagnetic Compatibility Directive).



06/2014 - Xerox Fabriano

GB

Essential Contact Information

HOTPOINT SERVICE - Service You Can Rely On

At Hotpoint we pride ourselves on offering our customers the best service we possibly can, wherever you are in the UK and Ireland. Rest assured though, no one knows a Hotpoint appliance better than we do and our service is second to none...

Wherever you are we can be there – we have over 1,000 highly skilled Hotpoint engineers covering the whole of the UK and Ireland ensuring fast, reliable, local service.

'Right first time' – our engineers have the latest tools to help get your Hotpoint appliance back up and running the first time we visit. Experts in our field – all of our engineers are trained to the highest standard at our Hotpoint Training Centre of Excellence with unrivalled expertise and product knowledge.

Skilled staff – we have over 400 skilled UK based call centre staff, dedicated to offering you excellent service 364 days a year.

Telephone in the United Kingdom: 08448 224 224

Telephone in the Republic of Ireland: 0818 313 413

www.hotpointservice.co.uk

Please note:

Our advisors will require the following information:

- name, address and postal code
- telephone number
- type of malfunction
- date of purchase
- model number
- serial number

This information can be found on the data plate located behind the door.

Indesit Company S.p.A.

Viale Aristide Merloni, 47

60044 Fabriano (AN)