

BUSH

Instruction manual

55/148F





Important Guarantee Information

Congratulations on purchasing this television. We hope you have many years of trouble free enjoyment from your purchase.

Your product is covered under the manufacturers guarantee for 12 months from the date of purchase.

If you experience any difficulties with your TV, please refer to the 'Frequently asked questions' section in this user guide.

If you are still unable to remedy the issue, try resetting the TV to factory settings. (Details in the 'Settings menu' section of this user guide). Alternatively you can contact the helpline on the number below.

In the event that a fault is diagnosed, the helpline will arrange to collect the TV from your home or work address, return it to our service centre, repair the item and then return it to you.

If we believe we cannot offer a permanent repair, we will replace the item.

Helpline Information

Telephone UK 0330 024 0805, ROI 01443 3940

Web support: www.umc-uk.co.uk

The telephone opening hours are Monday to Friday 8.30am to 6pm, Saturday 9am – 5pm. (Calls are charged at the standard rate of your network provider.)

You must retain all packaging materials, in addition to your proof of purchase/receipt, as you will need these in the event of warranty/service support.

This guarantee is in addition to and does not affect your statutory rights.

If you need to call the helpline, you will need the following information.

- 1) Model Ref _____ (You can find this on the rear of the TV)
- 2) Date of purchase _____ (You can find this on your sales receipt)
- 3) Serial Number _____ (You can find this on the rear of the TV)

EXAMPLE OF LABEL ON REAR OF TV

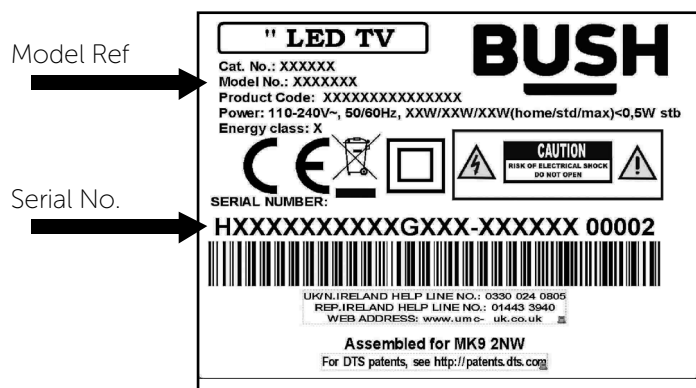

This TV is for domestic use only



If you require any technical guidance or find that your TV is not operating as intended, a simple solution can often be found in the **Troubleshooting** section of these instructions.



Contents

1 Safety information

Safety information 8-10

2 Getting to know your TV

Accessories 14

Stand installation 15

Detaching the stand 16

Securing the TV with anti-tip straps 16

Wall mounting 17

TV buttons 18

Remote control 19

3 Connections

TV buttons and input source 22

TV connections 23-24

4 Standard features

How to navigate the menus 28

Channel menu 29

Picture menu 30

Sound menu 31

Time menu 31

Setup menu 32

Lock menu 33

5 Advanced features

Network configuration 36

7 day TV guide 37

USB media player 38

6 Product support

Connecting a sky digital set top box 42-43

Frequently asked questions 44-45

Technical specification 46-47

Bush warranty information 48



For DTS patents, see <http://patents.dts.com>. Manufactured under license from DTS Licensing Limited. DTS, the Symbol, & DTS and the Symbol together are registered trademarks, and DTS TruSurround is a trademark of DTS, Inc. © DTS, Inc. All Rights Reserved.

or online at www.argos-support.co.uk If you still require further assistance, call one of our experts on 0330 024 0805. (Calls are charged at the standard rate of your network provider).





Safety information

1

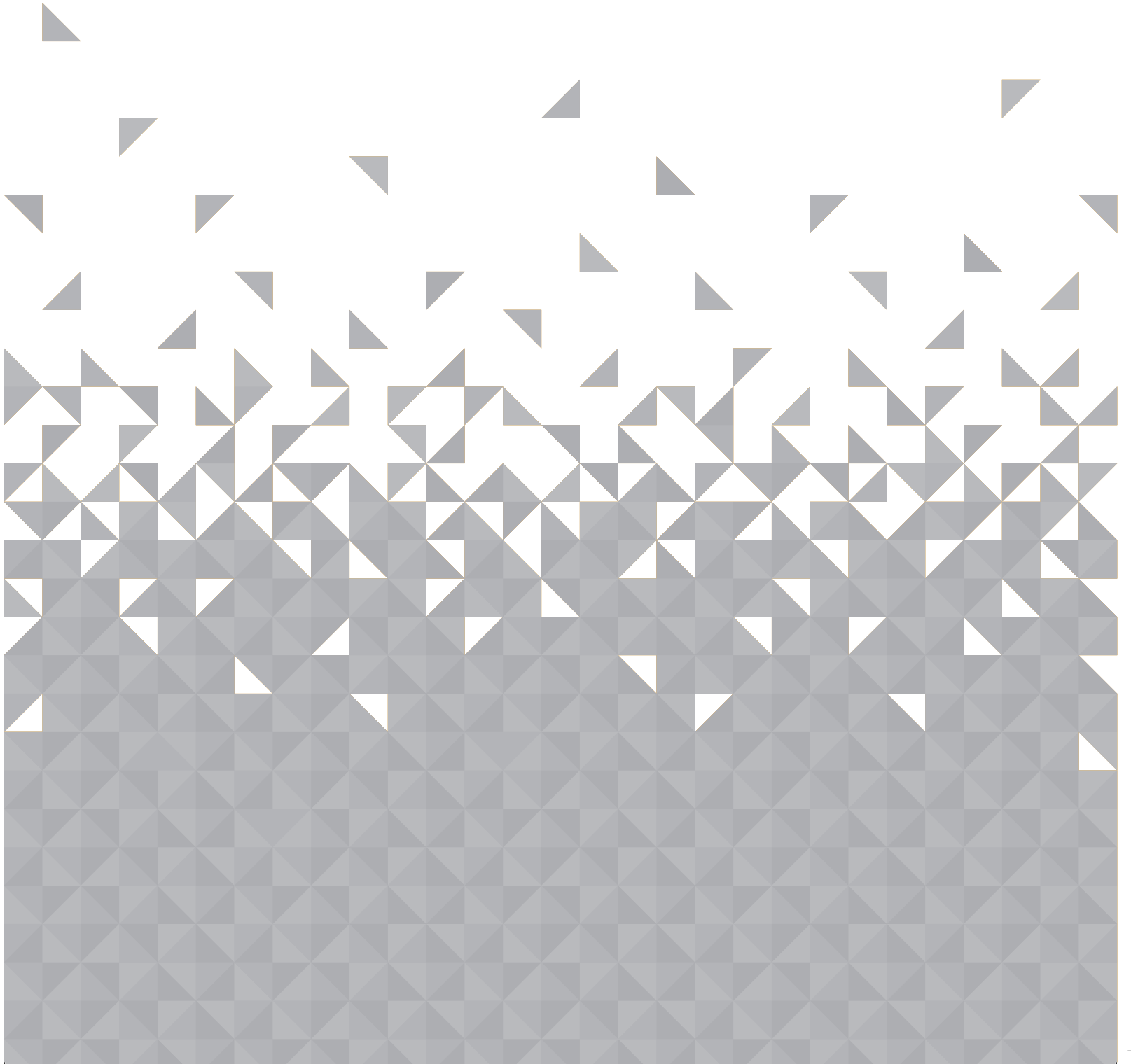



Safety information

Important - Please read these instructions fully before installing or operating



Warnings

- Television sets which weigh 20kg or more must be lifted and carried by at least 2 people.
- This television does not contain any parts that are serviceable by the user. In case of a fault, contact the manufacturer or authorised service department. Exposing the internal parts inside the TV may endanger your life. The manufacturer's guarantee does not extend to faults caused by repairs carried out by unauthorised third parties.

To prevent the spread of fire, keep candles or other open flames away from this product at all times



- To reduce the risk of fire, electric shock or damage to the TV, do not expose it to dust, rain or moisture. Never expose the TV to dripping or splashing and do not place objects filled with liquids on or near the TV.
- Do not connect any external devices (DVD player, games console etc) when the TV is switched on. Disconnect both the TV and device from the mains before connecting. Only switch appliances on when the connection process is complete.
- Do not place the television in a confined space and do not obstruct the ventilation openings at the rear of the television.
- When installing on a wall, ensure the TV is at least 5cm from the wall for ventilation.
- Always ensure that the TV's ventilation openings are not covered with items such as newspapers, table-cloths, curtains, etc.
- Ensure this TV is used in moderate climates only.

WARNING - Never place a television set on an unstable location. A television set may fall, causing serious personal injury or death. Many injuries, particularly to children, can be avoided by taking simple precautions such as:

- Use cabinets or stands recommended by the manufacturer of the television set.
- Only use furniture that can safely support the television set.
- Ensure the television set is not overhanging the edge of the supporting furniture.
- Do not place the television set on tall furniture (for example, cupboards or bookcases) without anchoring both the furniture and the television set to a suitable support.
- Do not place the television set on cloth or other materials that may be located between the television set and supporting furniture.
- Please educate children about the dangers of climbing on furniture to reach the television set or its controls.
- If your existing television set is being retained and relocated, the same considerations as above should be applied.

Safety

- Dispose of this television and any components including batteries in an environmentally friendly manner. If in doubt, please contact your local authority for details of recycling.
- For your safety, this appliance is fitted with a fused 3 pin mains plug. Should the fuse need to be replaced, ensure that any replacement is of the same amperage and approved with the BSI mark.
- Never try and replace the mains plug unless you have adequate qualifications and are legally authorised to do so. In the event that a replacement mains cable is required, contact the manufacturer for a suitable replacement.
- Never use the television if it is damaged in any way.

If you require any technical guidance or find that your TV is not operating as intended, a simple solution can often be found in the **Troubleshooting** section of these instructions.



Safety information

Important - Please read these instructions fully before installing or operating

- Always place the television on a flat level surface avoiding anywhere which may be subject to strong vibration.
- The ideal distance to watch the television is approximately five times the length of the diagonal measurements of the TV screen. Ensure the television is not placed on top of the power cable as the weight of the television may damage the cable and cause a safety hazard.
- Never place mobile phones, speakers or any other device which may cause magnetic or radio interference, near the television. If interference is apparent, move the device causing the interference away from the television.
- To isolate the TV from the mains power, please use the power switch located on the side, underside or rear of the TV set.
- Ensure that the power switch on the unit and the mains plug are always easily accessible.

WARNING: Excessive noise when using earphones and headphones can cause loss of hearing.

- To clean your TV, wipe with a soft, dry cloth. If the surfaces are extremely dirty, use a soft cloth dipped in a soap and water solution or a weak detergent solution.
- Never use alcohol, paint thinner or benzene to clean this unit.
- Before using a chemically treated cloth, read the instructions that came with the cloth carefully.

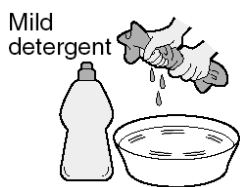

CAUTION: If water or other liquid enters the television through the display panel surface, a malfunction may occur.

Packaging

- The safest way to transport your item is in the original box/packaging - please save your packaging for this.
- You will need the original box/packaging in the event of warranty/service repair or support. We are unable to carry out warranty/service if you are unable to package the item correctly.

IMPORTANT: Information regarding use of video games, computers, captions or other fixed image displays

The extended use of fixed image program material can cause a permanent "shadow image" on the LCD/LED panel, also known as "screen burn".

This "shadow image" can appear in the background during normal viewing. This type of irreversible LCD/LED panel deterioration can be limited by observing the following steps:

1. Reduce the brightness/contrast setting to a minimum suitable viewing level.
2. Do not display the fixed image for extended periods of time.
3. Turn the power off when not in use.

Examples of images that are more likely to cause "screen burn" are as follows:

- TV channel logos: e.g. shopping channel logos and pricing displays - especially if they are bright and stationary. Moving or low-contrast graphics are less likely to cause ageing of the screen.
- Teletext: Do not view a stationary page for a long period of time
- Time displays.
- TV/DVD menus: e.g. listings of DVD disc content.
- Pause mode: Do not leave the TV in pause mode for long periods of time, e.g. when watching DVDs or videos.

IMPORTANT: Once 'shadow image/screen burn' occurs, it will never disappear and is not repairable under warranty.



Safety information

Important - Please read these instructions fully before installing or operating

Disposal



UK: Waste electrical products should not be disposed of with household waste. Please dispose of the product at a designated collection point for recycling of WEEE. For your nearest facilities, please see www.recycle-more.co.uk or in store for details.

ROI: Waste electrical products should not be disposed of with household waste. Separate disposal facilities exist. Check with your local authority or retailer for recycling advice.

Batteries



Cd

- Do not expose batteries to high temperatures, excessive heat, prolonged sunshine or fire as this may cause leakage, explosion or ignition. Observe the correct polarity when inserting batteries.
- Do not use different types of batteries together or mix old and new batteries.
- Dispose of batteries in an environmentally friendly way.
- Certain regions may regulate the disposal of batteries. Please consult your local authority.

- HDMI, the HDMI logo and High-Definition Multimedia Interface are trademarks or registered trademarks of HDMI Licensing LLC.
- The "HD TV" Logo is a trademark of DIGITALEUROPE.
- The "HD TV 1080p" Logo is a trademark of DIGITALEUROPE.
- The DVB logo is the registered trademark of the Digital Video Broadcasting - DVB – project.
- Manufactured under license under U.S. Patent Nos: 5,956,674; 5,974,380; 6,487,535 & other U.S. and worldwide patents issued & pending. DTS, the Symbol, & DTS and the Symbol together are registered trademarks & DTS 2.0+Digital Out is a trademark of DTS, Inc. Product includes software. © DTS, Inc. All Rights Reserved.
- FREEVIEW HD
The FREEVIEW HD words and logos are trade marks of DTV Services LTD. © DTV Services Ltd.

If you require any technical guidance or find that your TV is not operating as intended, a simple solution can often be found in the **Troubleshooting** section of these instructions.



or online at www.argos-support.co.uk If you still require further assistance, call one of our experts on **0330 024 0805**. (Calls are charged at the standard rate of your network provider).







Getting to know your TV

2

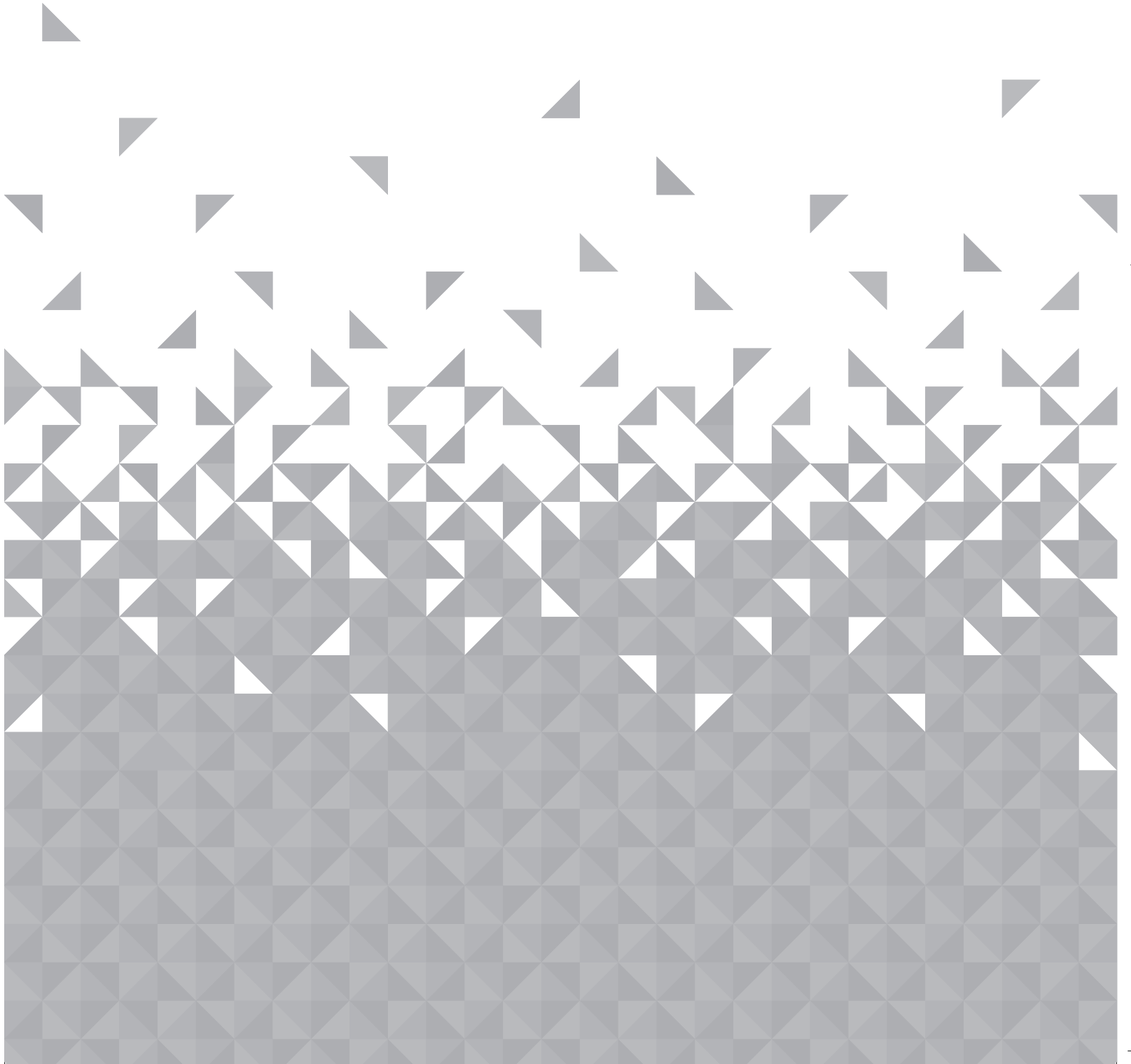

Getting to know your TV

You'll be up and running in no time

Accessories

1 x User guide

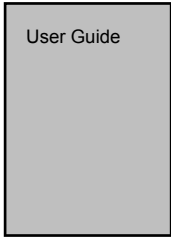

1 x Quick start guide



1 x TV



1 x RF cable



1 x Remote control



2 x AAA batteries



1 x Mini Component / YPbPr Cable



1 x Mini AV Cable

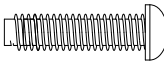

1 x Standard installation pack

4 x 

1 x L (left)

1 x R (right)

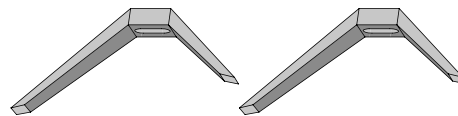

Note: Please save your box/packaging as you will need this in the event of warranty/service repair or support. We are unable to carry out warranty/service if you are unable to package it correctly. The safest way to package your item in the event of warranty/service repair is in its original box/packaging.

If you require any technical guidance or find that your TV is not operating as intended, a simple solution can often be found in the **Troubleshooting** section of these instructions.

Getting to know your TV

You'll be up and running in no time

Stand installation

To complete the stand installation you will require a cross head screw driver.

The stand installation pack comes with 4 screws and 2 x stand feet.

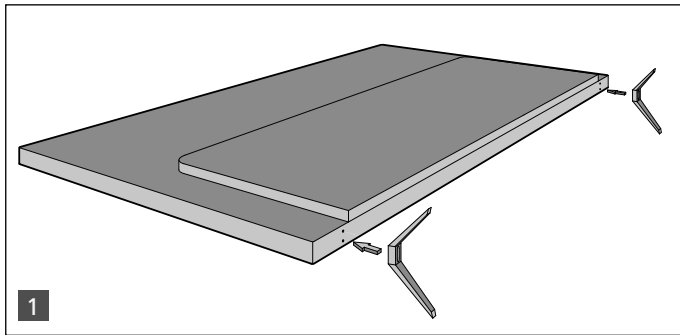
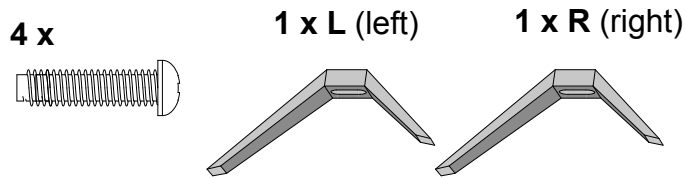

fig 1) Place the TV set on a flat and clean surface with the panel facing downwards to avoid damage, then fix the stand feet shown.

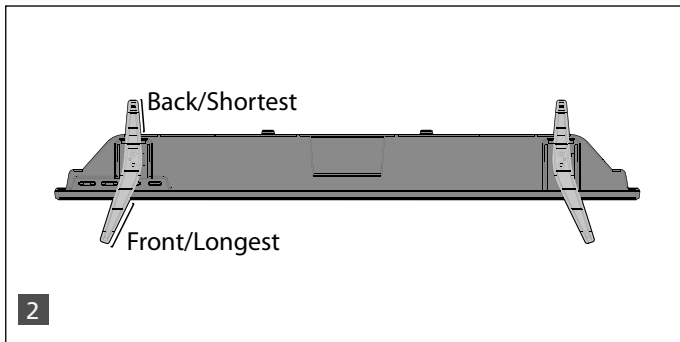

fig.2) When the stand feet are installed correctly the stand feet will be longest at the front of the TV and shortest at the back with the feet pointing away from each other.

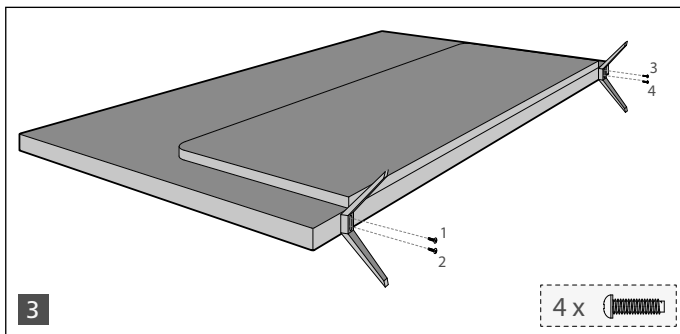

fig 3) When the stand feet are in the correct position, secure the stand feet to the underside of the TV set using the 4 screws provided.

or online at www.argos-support.co.uk If you still require further assistance, call one of our experts on 0330 024 0805. (Calls are charged at the standard rate of your network provider).

Getting to know your TV

You'll be up and running in no time

Detaching the stand

To detach the stand please remove the 4 screws highlighted then remove the stand feet from the rear of the TV set.

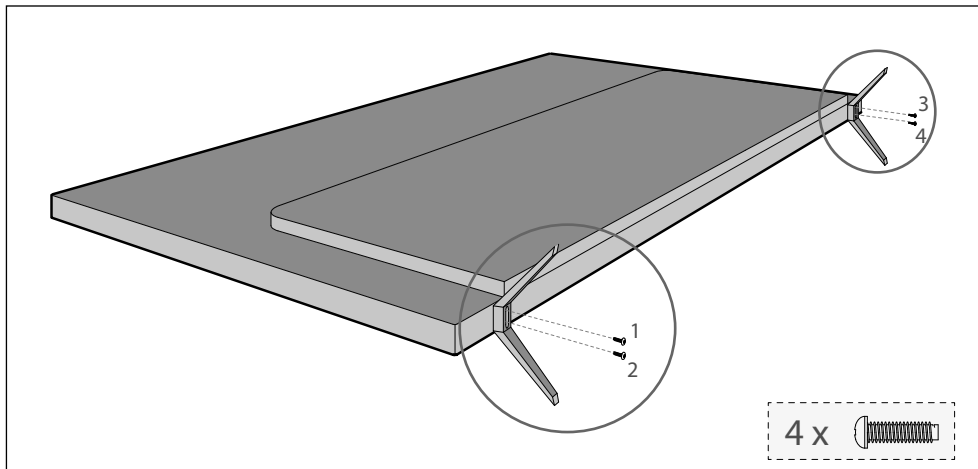

Securing the TV using anti-tip straps

For maximum security in the home, when using a TV with its stand, anti-tip straps should be fitted. These are available from supermarket websites and other websites and are an easy, inexpensive and effective way of ensuring your TV stays safely upright. Straps are designed to be attached to the rear of the TV and then tethered to the wall or the furniture the TV is stood on, these are fitted as follows.

NOTE: Please ensure that children do not climb on the TV set.

A) Using one or both of the top wall-mounting holes and screws fasten one end of the fastening cord/s to the TV. (the screws are already supplied in the wall mounting holes)

B) Secure the other end of the fastening cord/s to your wall. (you will need screws/fixings suitable for your wall type - available separately from most DIY stores).

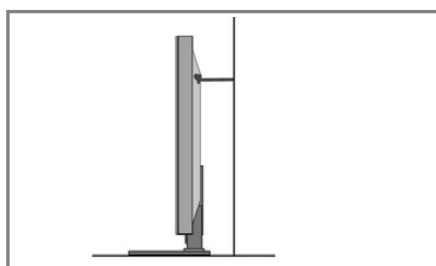
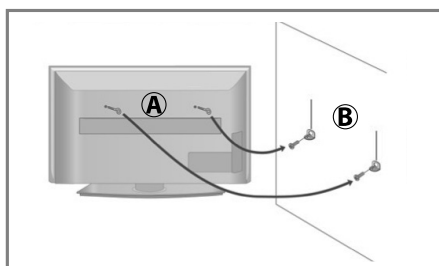

The Royal Society for the Prevention of Accidents is urging people to take care with flat-screen televisions.

RoSPA stated in 2010 that "Toddlers are particularly at risk of pulling flat-screen televisions on to themselves. They are unsteady on their feet and are attracted by colourful television images."

The risk is increased as televisions become lighter.

If you require any technical guidance or find that your TV is not operating as intended, a simple solution can often be found in the **Troubleshooting** section of these instructions.

Getting to know your TV

You'll be up and running in no time

Wall mounting

IMPORTANT: Before drilling any holes in the wall ensure you are not drilling where there could be any electric wires, water or gas pipes.

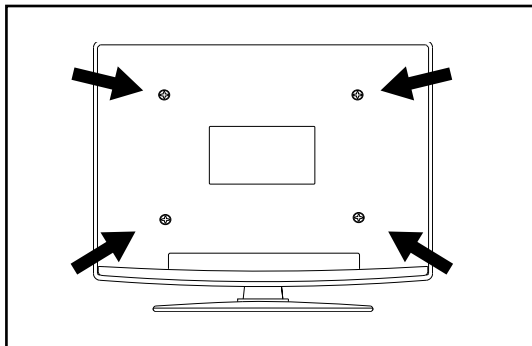

- 1) Remove the four screws located at the back of the TV set.
- 2) The wall mount can now be easily attached to the mounting holes, located on the back of the TV, using the same four screws removed.

IMPORTANT: If wall mounting this TV, only use the screws already provided in the wall mounting holes. Using other screws which are longer could cause irreparable damage to internal parts.

For optimum viewing, if wall mounting the TV higher than eye level, the TV should be tilted downwards so that the TV's screen is 'face on'. See fig 1 and 2 below.

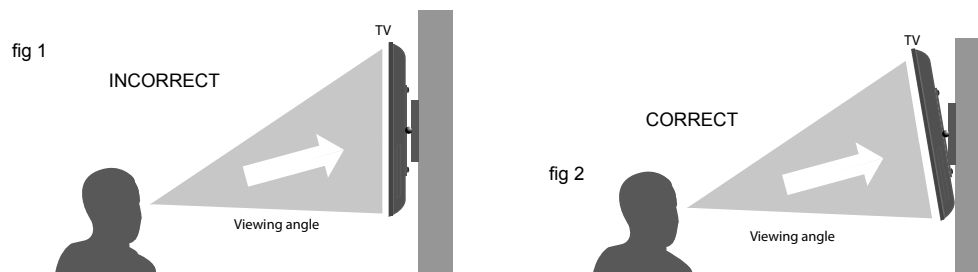

For VESA wall mounting information please refer to the Technical Specification page.

or online at www.argos-support.co.uk If you still require further assistance, call one of our experts on 0330 024 0805. (Calls are charged at the standard rate of your network provider).

Getting to know your TV

You'll be up and running in no time

TV buttons and input source

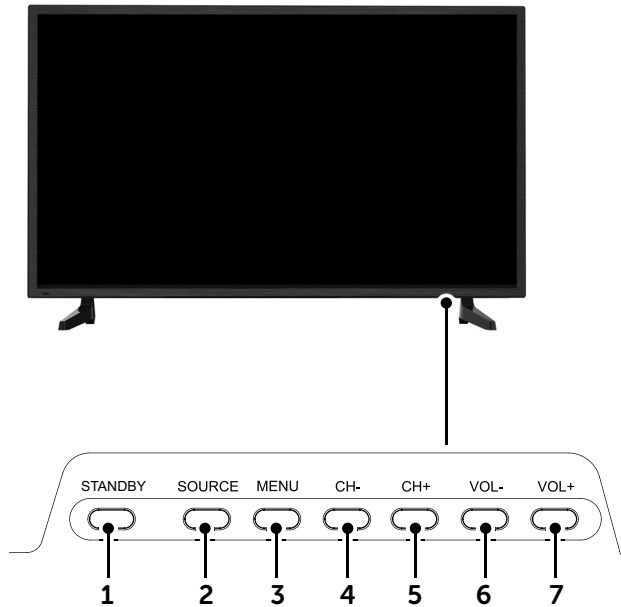

- 1) Standby Power On/Off
- 2) Displays the input source menu
- 3) Displays Menu/OSD
- 4) Programme/Channel down and menu down
- 5) Programme/Channel up and menu up
- 6) Volume down and menu left
- 7) Volume up and menu right

Choosing mode and input/source

To switch between the different input/connections.

A) Using the buttons on the remote control:

- 1) Press [SOURCE] - The source menu will appear.
- 2) Press [V] or [^] to select the input you require.
- 3) Press [OK].

B) Using the buttons on the Television:

- 1) Press [SOURCE].
- 2) Scroll up / down using CH+/ CH- buttons to the input/source you require.
- 3) Press Vol+ to change input/source to the one selected.

For further information on input/connections please view 'Connections' pages.



Example of Source menu depending on the TV model

If you require any technical guidance or find that your TV is not operating as intended, a simple solution can often be found in the **Troubleshooting** section of these instructions.

Getting to know your TV

You'll be up and running in no time

Remote control functions

⊙ For Models with Integrated DVD players

▶ For Models with PVR Function

📀 For Models with USB Playback

△ For Models with 3D Feature

1) STANDBY

2) MUTE

3) DTV

4) RADIO

⊙ 5) DVD

📀 6) USB

7) NUMBER BUTTONS

8) TV GUIDE

9) ↻ - To return to the previous channel viewed

10) P.MODE - Scrolls through picture mode options

11) VOL ▲/▼

12) CH ▲/▼

13) S.MODE - Scrolls through sound mode options

14) FAV - To display favourites menu

15) MENU

16) EXIT

17) (▲/▼/◀/▶/OK) - Allows you to navigate the on-screen menus and adjust the system settings to your preference

18) SOURCE/AV

19) INFO - Press once for now/next channel information. Press twice for programme information about current programme

20) ASPECT

21) SLEEP

22) SUBTITLE

23) AUDIO

24) TEXT

25) TEXT HOLD

26) DISPLAY

⊙ 27) TEXT ZOOM/DVD ZOOM

📀 ⊙ 28) DVD Menu/Record:

⏮ - To restart the current chapter

⏭ - To advance forward to the next chapter

⏏ - To stop/eject Disc (hold for 4 seconds to eject disc)

⏪ - To play in fast rewind mode

⏩ - To play in fast forward mode

⏸ - To play/pause

▶ 29) REC LIST

▶ 30) GOTO

▶ 31) A-B

▶ 32) REPEAT

⊙ 33) ANGLE/ △ 3D - Change to 3D mode

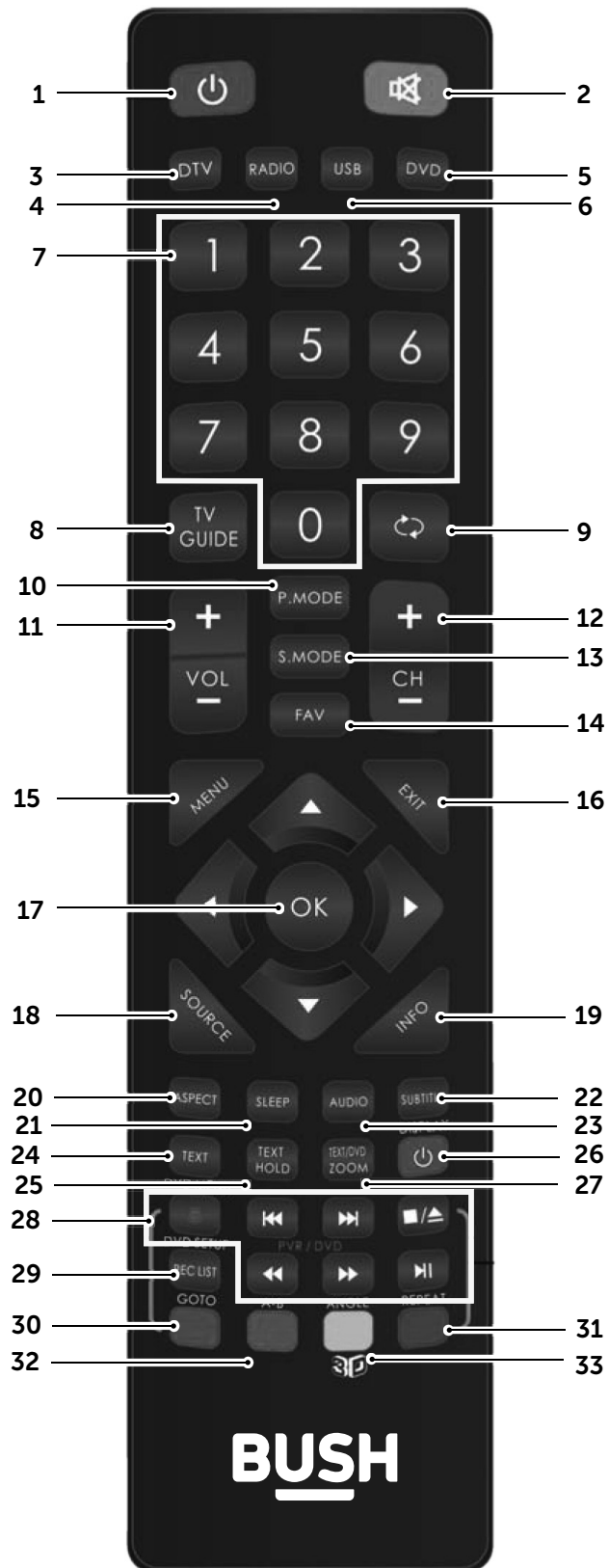

or online at www.argos-support.co.uk If you still require further assistance, call one of our experts on 0330 024 0805. (Calls are charged at the standard rate of your network provider).





Connections

3

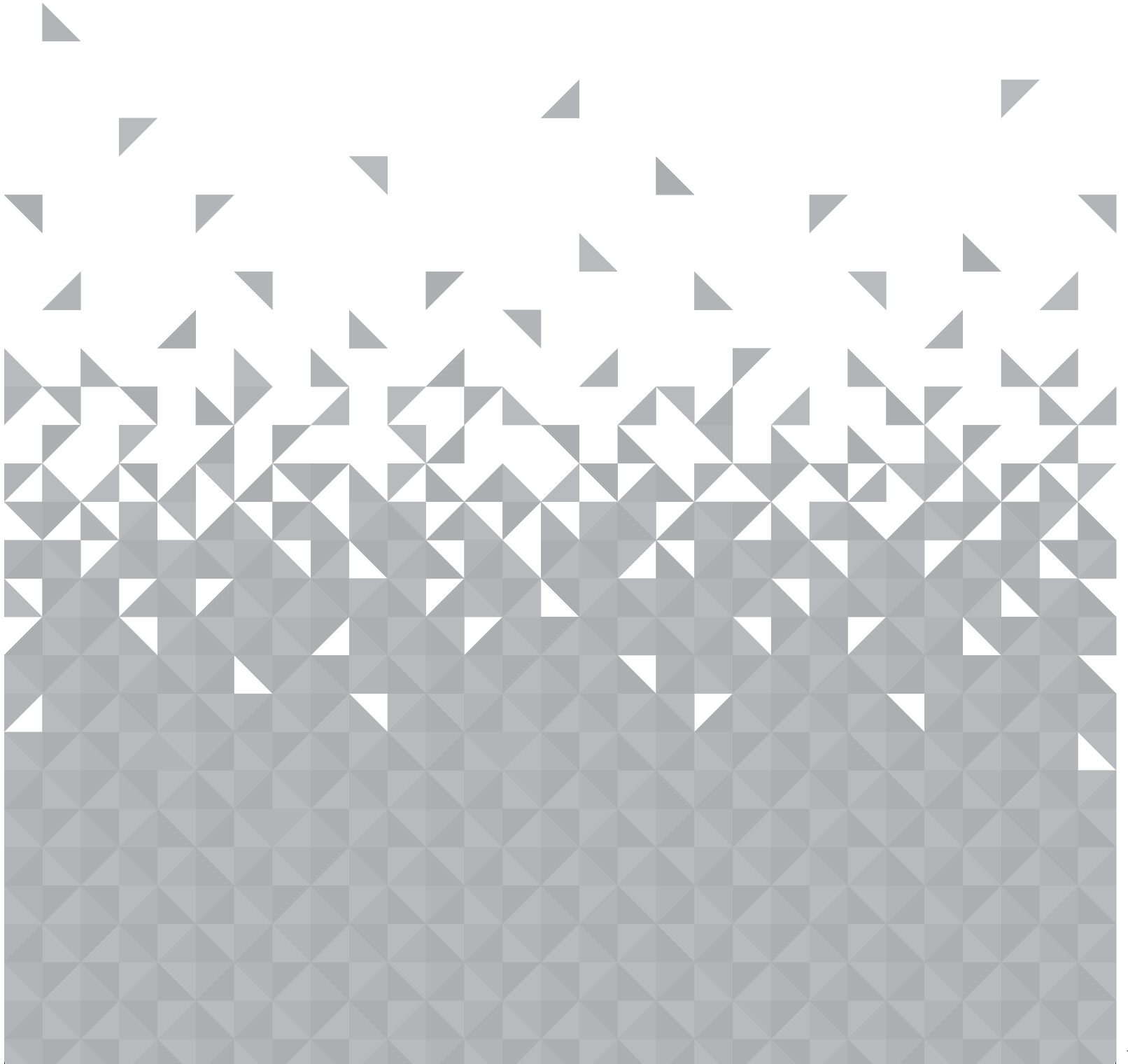

Connections

Bringing it all together

Connections

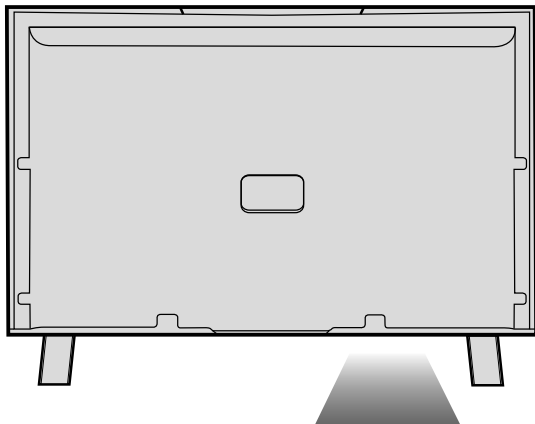

- | | | |
|----|-----------------|------------------------------|
| 1 | LAN* | Network connection |
| 2 | DIGITAL AUDIO | Digital optical audio output |
| 3 | HDMI 1 | HDMI input |
| 4 | HDMI 2 (ARC) | HDMI input |
| 5 | VGA/PC | VGA/PC input |
| 6 | VGA/PC AUDIO IN | 3.5mm PC audio input |
| 7 | RF IN | RF / TV aerial input |
| 8 | EARPHONE | Earphone socket |
| 9 | HDMI 3 | HDMI input |
| 10 | COMPONENT (HD) | Component input (YPbPr) |
| 11 | AV IN | Audio/Video input |
| 12 | CI CARD IN | Common Interface module |
| 13 | USB | USB input |

*The Ethernet port is used only for Freeview HD services only.

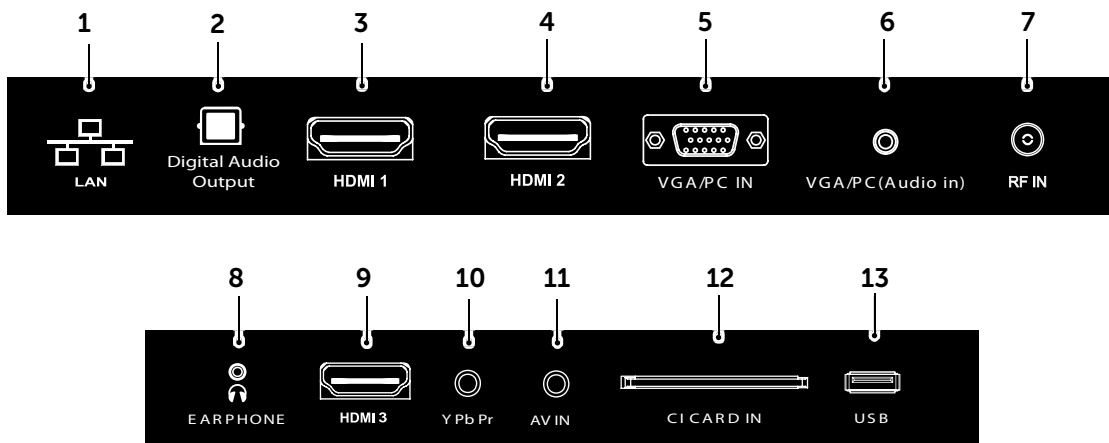

If you require any technical guidance or find that your TV is not operating as intended, a simple solution can often be found in the **Troubleshooting** section of these instructions.

Connections

Bringing it all together

Connections

Connecting a camcorder, camera or games console.

The TV source should be set to composite/AV.

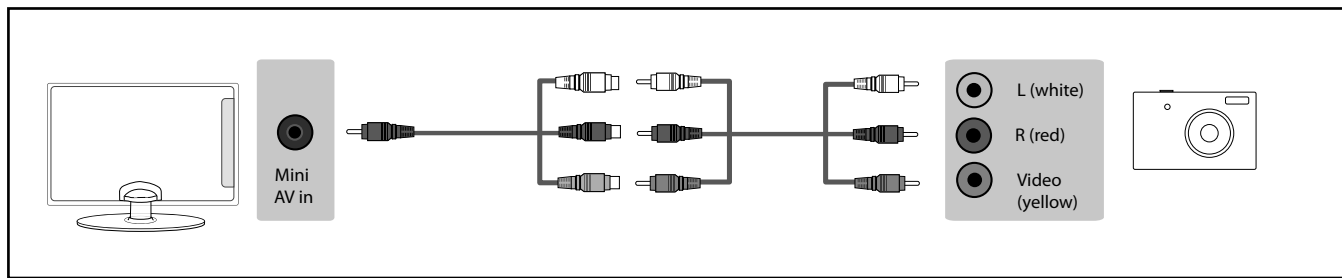

Connecting a DVD player/recorder, video recorder or cable/satellite box.

Source should be set to composite/video.

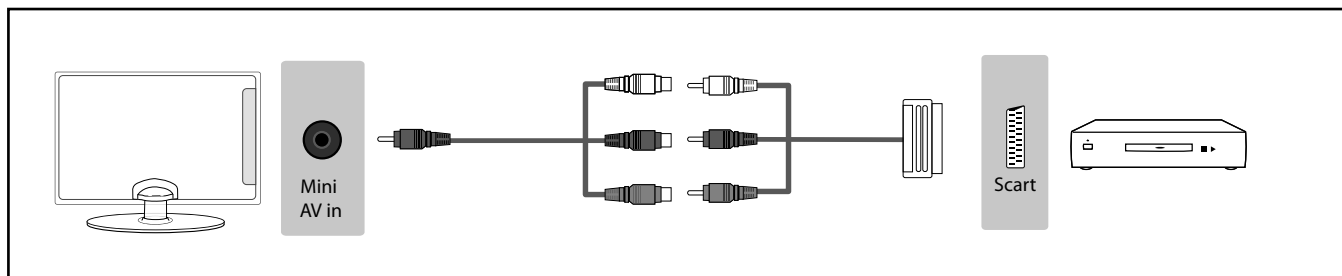

Connecting a High Definition (HD) Device Option 1 - via HDMI to HDMI cable

A HDMI cable can output both video and audio and enables you to enjoy digital-quality video and audio with minimal loss of quality.

TVs Source should be set to the corresponding HDMI Port (HDMI 1, HDMI 2, etc).

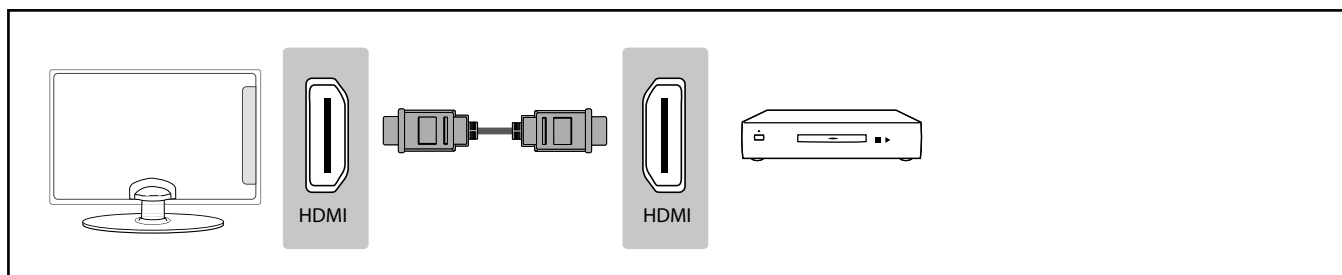

or online at www.argos-support.co.uk If you still require further assistance, call one of our experts on 0330 024 0805. (Calls are charged at the standard rate of your network provider).

Connections

Connecting a High Definition (HD) Device Option 2 - via Component cable

If you are supplied with a cable from the device which has RED, GREEN, BLUE, RED & WHITE connectors you must connect via Component (for picture) and by phono cable (for sound).

TV Source should be set to Component/YPbPr.

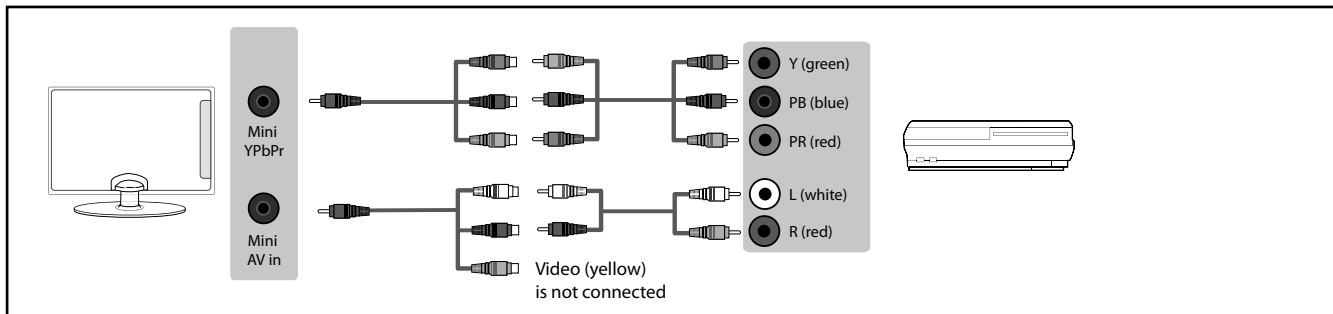

Connecting to a device with VGA/PC output (Laptop or Desktop Computer)

Source should be set to VGA/PC

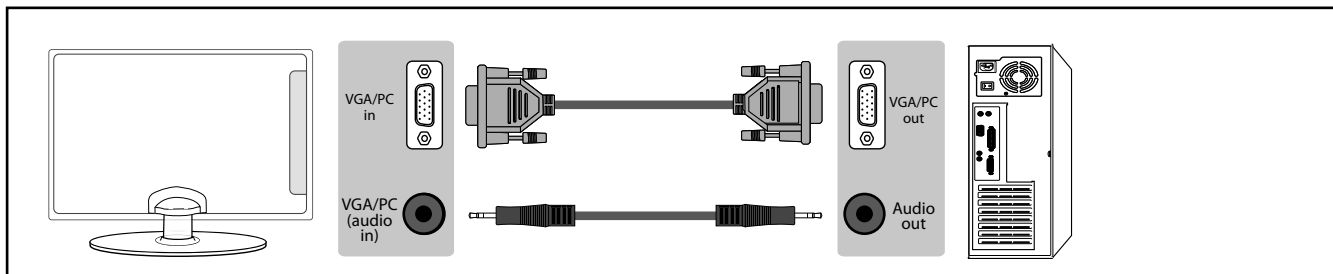

Connecting to an external audio device (Amplifiers, Surround Sound, Sound Bars etc)

When connecting via the TV's 3.5mm Earphone output, this will disable the TV speakers.

There are two options when connecting a device via the 3.5mm Earphone Output and the Digital Optical Audio Output

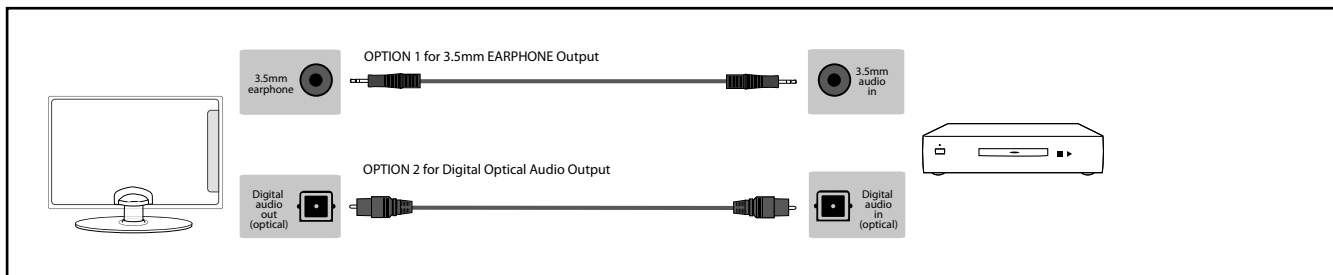

Connecting an Ethernet/Network cable

The Ethernet port is used only for Freeview HD services only.

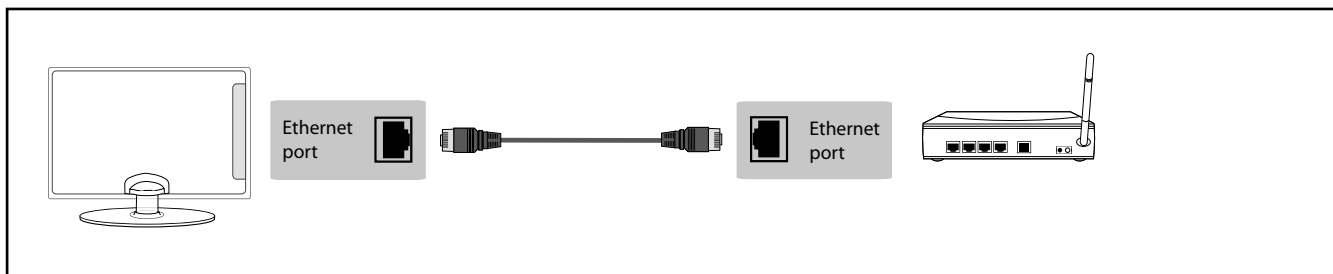

If you require any technical guidance or find that your TV is not operating as intended, a simple solution can often be found in the **Troubleshooting** section of these instructions.







Standard features

4

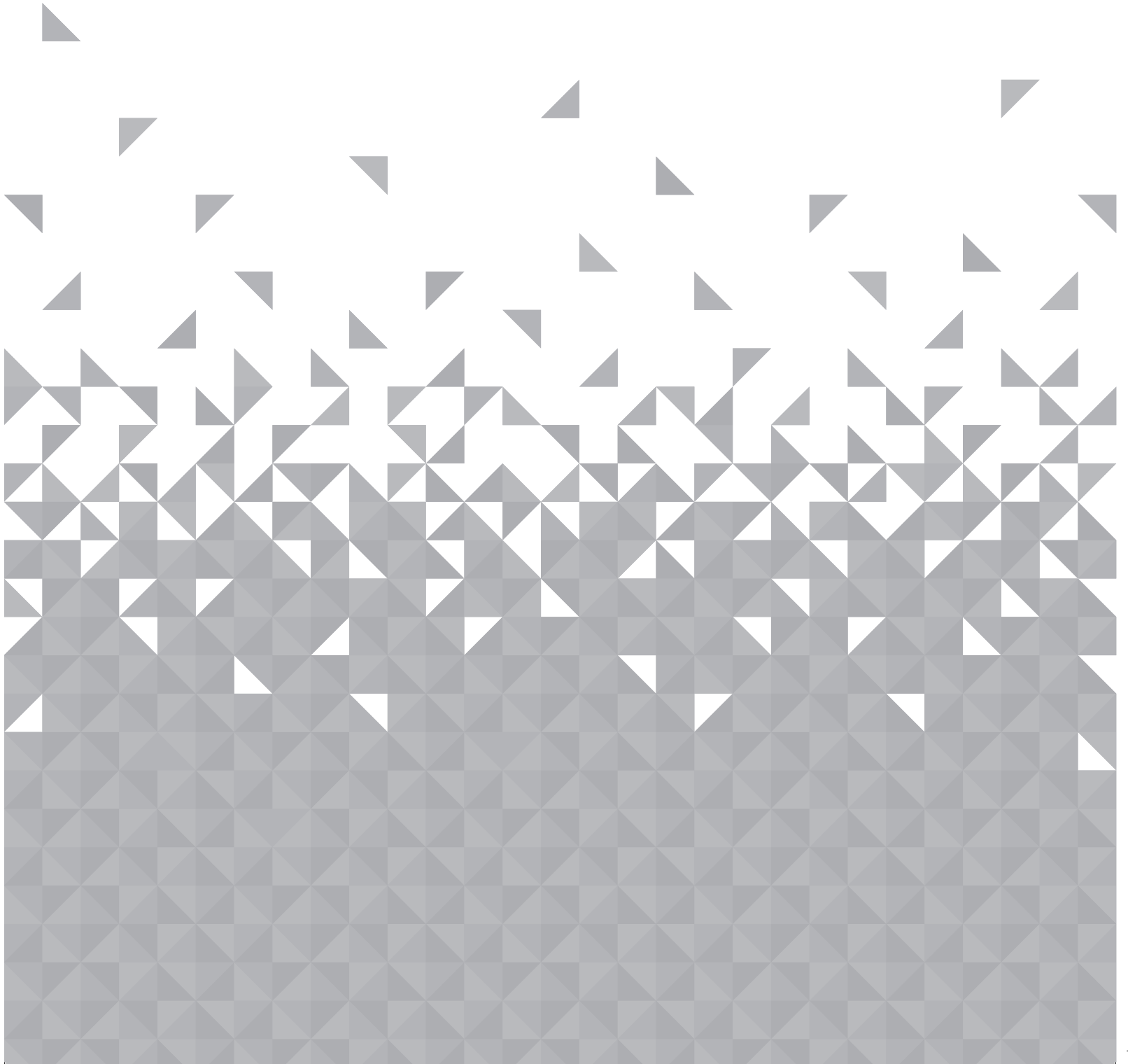

Standard features

Simple everyday use

How to navigate the menu

To access this menu, press [MENU] button on the remote control. To enter a menu press [OK]

If you wish to make changes to any of the default settings, use the scroll ▲▼▶◀ buttons. To confirm any settings press [OK] button.

To exit this menu at anytime, press [EXIT] button.



Tip: If you do not press any buttons for 30 seconds, the menu will automatically exit. You can change the length of time before the menu exits automatically - see 'OSD Timer' in the Time Menu.

If you require any technical guidance or find that your TV is not operating as intended, a simple solution can often be found in the **Troubleshooting** section of these instructions.

Standard features

Simple everyday use

Channel menu



Auto Tuning - Allows you to retune the television for all digital channels, digital radio stations and analogue channels.

Freeview Manual Tuning - Allows you to manually tune your digital signal

Analogue Manual Tuning - Allows you to manually tune your analogue signal

Channel Edit - Allows you to delete, move, skip and add favourite channels.

Signal Information - Displays signal strength information

CI Information - Pay per view services require a "smartcard" to be inserted into the TV. If you subscribe to a pay per view service the provider will issue you with a 'CAM' and a "smartcard". The CAM can then be inserted into the COMMON INTERFACE PORT (CI Card In).

Schedule List - Lists your programme reminders

Software Update (OAD) - Switch on/off OAD updates

Tip: If you do not press any buttons for 30 seconds, the menu will automatically exit. You can change the length of time before the menu exits automatically - see 'OSD Timer' in the Time Menu.

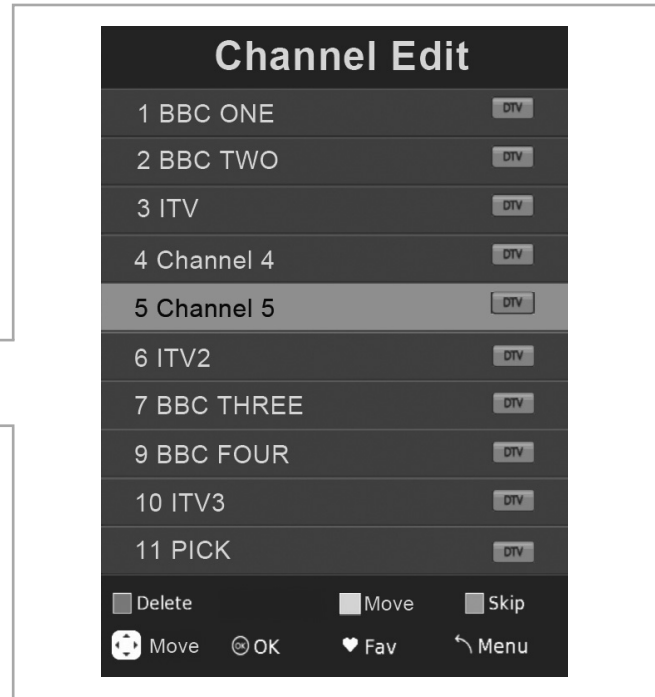

Important: To receive Freeview channels, in particular Freeview HD channels, you will need a Digital TV aerial and be in a good Freeview coverage area. You can check coverage for your postcode at www.freeview.co.uk

Please note that any Freeview HD channels found during tuning will be placed in channel positions above 100. For example, 101 (BBC1 HD) 102 (BBC2 HD) etc.

Standard features

Simple everyday use

Picture menu



Dynamic - Recommended settings for fast moving pictures.

Standard - Default settings.

Mild - Set to be lighter in colour and less bright.

Personal - Lets you manually alter all the settings.

Economy - Power saving mode which reduces the energy used by up to 25% (by reducing the power to the LED/LCD panel). In Economy mode, the TV will switch itself to Standby mode after 3-5 hours in the event that the TV buttons or remote control buttons are not pressed (change the picture mode to another setting to de-activate this function).

Contrast - Switch the balance between black and white.

Brightness - Increase or decrease the brightness of the picture.

Colour - Increases the colour from black and white.

Tint - Lets you increase or decrease the level of tint within the picture (only available in VGA/PC source mode).

Sharpness - Increase or decrease the sharpness of the picture.

Colour Temperature

- **Normal** - Default settings.
- **Warm** - Increases red within the picture.
- **Cool** - Increases blue within the picture.

Aspect Ratio - Within the UK the picture format varies depending on the channel/broadcast. There are a number of different options to best meet your needs.

- **Point2Point** - Will display the picture in its original resolution without any change. Only available when the TV source is set to HDMI.
- **Auto** - Automatically displays the best picture format. So the picture is in the correct position. May have black lines at the top/bottom and/or sides.
- **4:3** - Displays the 4:3 picture in its original size. Side bars are shown to fill the 16:9 screen.

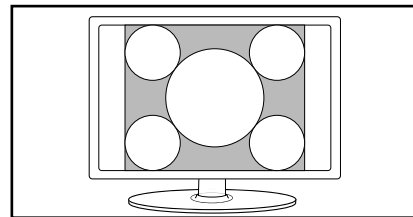

- **16:9** - Fills the screen with a regular 16:9 signal and 4:3 will stretch to fill the screen.

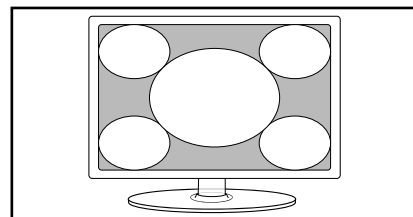

- **Zoom1 and Zoom 2** - The picture is the correct proportion but zoomed in to fill the screen.

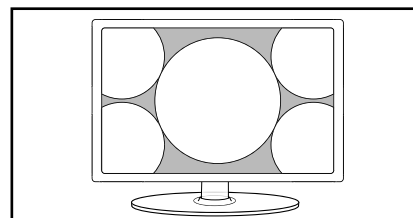

Noise Reduction

- **Off** - Turns noise reduction off.
- **Low** - Minor system adjustment.
- **Middle** - Medium system adjustments.
- **High** - Maximum system adjustments.

Screen - Allows you to adjust screen settings when the TV is used a PC monitor and the TV is set to VGA/PC source.

If you require any technical guidance or find that your TV is not operating as intended, a simple solution can often be found in the **Troubleshooting** section of these instructions.

Standard features

Simple everyday use

Sound menu



Sound Mode

Standard - Default settings.

Music - Emphasises music over voices.

Movie - Provides live and full sound for movies.

Sports - Emphasises sound for sports.

Personal - Selects your personal sound settings.

Balance - To switch the sound between the left and right speakers.

Auto Volume Level (AVL) - When 'on' is selected, the volume will stay at a constant level regardless of input/source.

Surround Sound

- **Off** - Off.
- **TruSurround HD** - TruSurround HD™ creates an immersive, feature-rich surround sound experience from two speakers, complete with rich bass, high frequency detail and clear dialog.

Audio Description - This allows the user to increase and decrease the AD (Audio Description) volume level. (Audio Description is a service available on certain programmes. It provides a description of what is happening during the selected programme for a person who is visually impaired).

Digital Output

- **Off** - Off.
- **Auto** - Selects the best settings automatically.
- **PCM** - Select this option if you are connecting to a Stereo Hi-fi via coax cable (Pulse-code modulation (PCM) is a digital representation of an analogue signal).

Audio Delay - Enables the user to adjust setting to sync picture and audio.

Tip: Treble and bass levels can only be adjusted when the sound mode 'personal' is selected.



For DTS patents, see <http://patents.dts.com>. Manufactured under license from DTS Licensing Limited. DTS, the Symbol, & DTS and the Symbol together are registered trademarks, and DTS TruSurround is a trademark of DTS, Inc. © DTS, Inc. All Rights Reserved.

or online at www.argos-support.co.uk If you still require further assistance, call one of our experts on 0330 024 0805. (Calls are charged at the standard rate of your network provider).

Standard features

Simple everyday use

Time menu



Clock - Shows the date and time.

Time Zone - Change your current time zone.

Sleep Timer - Lets you set the sleep timer so the television automatically switches off after a set amount of time. Off -> 10min -> 20min -> 30min -> 60min -> 90min -> 120min -> 180min -> 240min.

OSD Timer - Lets you adjust the amount of time the On Screen Menu stays on the screen before disappearing.

Auto standby - Set Auto standby between 3 hours, 4 hours and 5 hours (to turn off this function you must exit Home Mode in the Picture Menu).

Setup menu

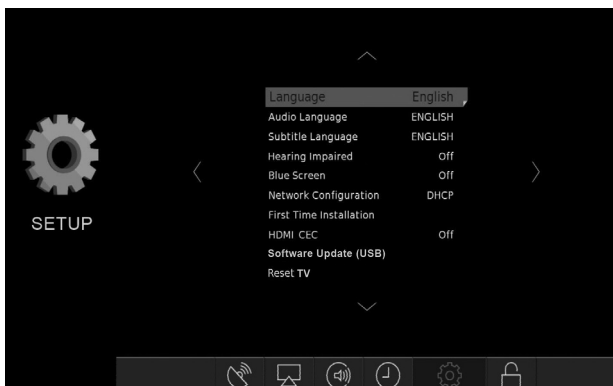

Language - Allows you to change the language of the menu.

Audio language - Allows the user to change the audio language.

Subtitle Language - Allows the user to change the subtitle language.

Hearing Impaired - This allows the user to turn on the Hearing Impaired function, this produces subtitles on the screen which provide a description of what is happening during the selected program.

PVR File System - Allows you to view the format and performance of a USB key.

Blue Screen - Changes the background when there is no input between clear and a blue background (Only available on some sources).

Network Configuration - Allows you to manually set your network settings on the TV (for more information please see 'Network Configuration' page).

First Time Installation - Allows you to retune the television for all digital channels, digital radio stations and analogue channels.

HDMI CEC (Consumer Electronic Control) - Allows HDMI devices to control each other and allows the user to operate multiple devices with one remote control. (only available with compatible devices)

Software Update (USB) - This menu lets you install the new software/firmware onto the television. Further details of how to do this will be issued with the firmware. Contact the helpline or refer to the 'product support' section of the website.

Reset TV - This resets the menus to factory settings and will erase all TV channels stored on the television.

If you require any technical guidance or find that your TV is not operating as intended, a simple solution can often be found in the **Troubleshooting** section of these instructions.

Standard features

Simple everyday use

Lock menu

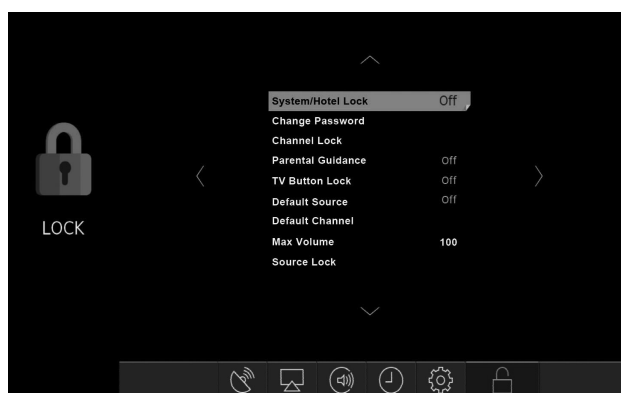

System/Hotel Lock - Allows you to lock or unlock the menu. You will be asked to enter a 4 digit password use the ◀ button to quit the password input. Use the ▶ button to clear. Default password is 0000

Change Password - Allows you to change the password

Channel Lock - Allows you to lock certain channels manually

Parental Guidance - Allows you to set the rating to block certain content based on age information

TV Button Lock - Allows you to lock the buttons on the side of the TV set

Default Source - Allows the user to set the default source. The default source is the source the TV starts on when first switched on

Default Channel - Allows the user to set a channel as the default channel on the Digital source. The default channel is the channel the TV starts on when first switched on

Max Volume - Allows you to adjust and set the maximum volume

Source Lock - Allows you to lock the source menu

or online at www.argos-support.co.uk If you still require further assistance, call one of our experts on 0330 024 0805. (Calls are charged at the standard rate of your network provider).





Advanced features

5

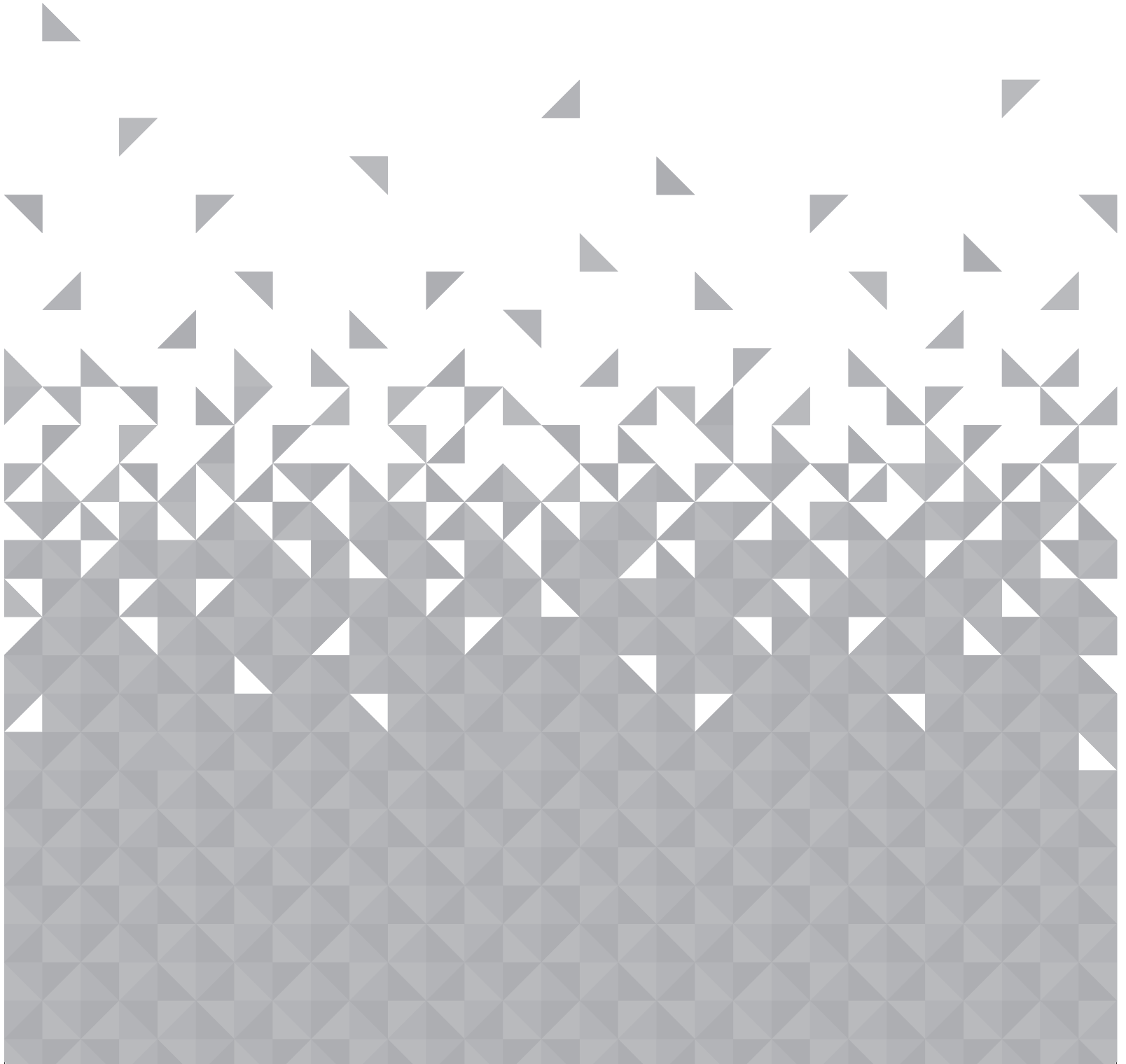

Advanced features

Getting the most from your TV

Network configuration

For the network configuration to work the TV will need to be connected to your home network via an Ethernet cable, with these requirements in place the TV will connect to the network automatically.

If you are looking to change the configuration to a static IP address this can be done by following the instructions below.

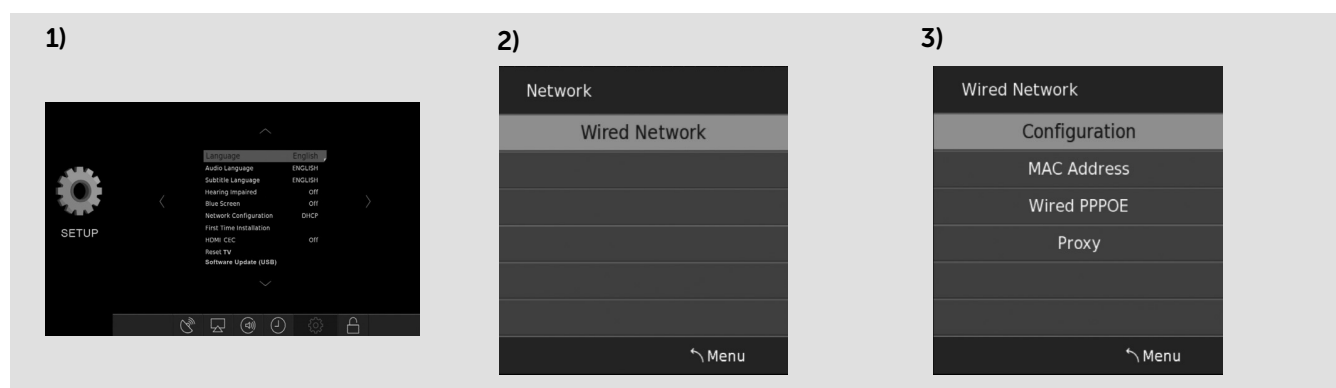

- 1) In the Setup Menu you will need to highlight and select Network Configuration.
- 2) When the Network menu appears highlight and select Wired Network.
- 3) Next the Wired Network menu will appear please highlight and select Configuration.

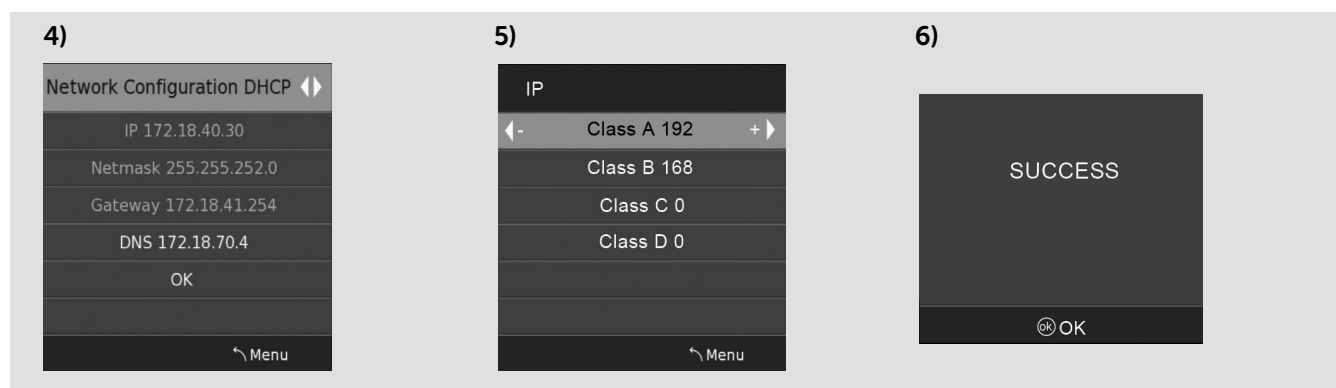

- 4) The Network Configuration menu allows you to choose between DHCP and Static.
DHCP - will automatically connect the TV to your home network (this is the default setting and is highly recommended).
Static - is an advanced option and allows you to manually change the IP, Netmask, Gateway and DNS information.
- 5) If the static option is chosen you will be able to scroll down and manually change the IP, Netmask, Gateway and DNS information.
- 6) When the connection process is completed with either DHCP or Static option the Success screen will appear.

If you require any technical guidance or find that your TV is not operating as intended, a simple solution can often be found in the **Troubleshooting** section of these instructions.

Advanced features

Getting the most from your TV

7 day TV guide and channel list

TV Guide is available in Digital TV mode. It provides information about forthcoming programmes (where supported by the freeview channel). You can view the start and end time of all programmes and on all channels for the next 7 days and set reminders.

1) Press [TV GUIDE]. The following 7 Day TV Guide will appear.

7 Day TV GUIDE		11 Dec 2014 12: 58			
1 BBC ONE Oxford		Lifestyle			
12:15 - 13:00 11 Dec 2014					
Norfolk: Tim wonnacott and the teams are in Norfolk in search of great buys to take to auction. Expertise comes from Catherine Southon and Jonathan Pratt, and Tim visits Ham House.					
CHANNEL	12:00	Now	13:00	13:30	
1 BBC ONE Oxford		Bargain Hunt	BBC News at One	South...	Doctors
2 BBC TWO		Daily Politics	Jame...	The Blue Planet	
3 ITV		Let's Do Christmas with Gino and Mel		ITV News & Weather	
4 Channel 4		Come Dine with Me	Come Dine with Me	Come Dine...	
5 Channel 5		Three Wise Women		5..	Home and Away
6 ITV2		Coronation Street	You've Been Framed!	Royal...	
7 BBC THREE		This is BBC Three			
9 BBC FOUR		This is BBC Four			
<input type="checkbox"/> Record	<input type="checkbox"/> Prev. Day		<input type="checkbox"/> Next Day	<input type="checkbox"/> Remind	
<input type="checkbox"/> Move	<input type="checkbox"/> Info	<input type="checkbox"/> EXIT	<input type="checkbox"/> OK		

2) Navigate through the menu using ▲▼▶◀

You can now:

View a previous day by pressing **GREEN**,

View the next day by pressing **YELLOW**

Set a reminder by pressing **BLUE**

3) Press [EXIT] to exit the 7 day TV Guide.

Channel list

Channel List	
1 BBC ONE	DTV
2 BBC TWO	DTV
3 ITV	DTV
4 Channel 4	DTV
5 Channel 5	DTV
6 ITV2	DTV
7 BBC THREE	DTV
9 BBC FOUR	DTV
10 ITV3	DTV
11 PICK	DTV
<input type="checkbox"/> HD <input type="checkbox"/> SD <input type="checkbox"/> Radio <input type="checkbox"/> All	Move
	Exit

To view the channel list, please ensure that the TV is set to either the analogue or digital source and no menus or TV notifications are displayed.

1) Press [OK] on the remote control and the channel list menu will appear.

2) Scroll through the channel list by using ▲▼ buttons then press [OK] to view the channel that is currently highlighted.

You can also:

View Freeview HD channels by pressing **RED**

View standard definition Freeview channels by pressing **GREEN**

View radio channels by pressing **YELLOW**

View all channels by pressing **BLUE**

3) Press [EXIT] to exit the channel list.

or online at www.argos-support.co.uk If you still require further assistance, call one of our experts on 0330 024 0805. (Calls are charged at the standard rate of your network provider).

Advanced features

Getting the most from your TV

USB media player

USB mode offers playback of various different types of content that you have saved on your USB Memory Stick.

On switching to USB source the menu screen will appear. The content will be divided into Photo, Music, Movie and Text based on file type.

- 1) You can navigate through the menus using the scroll ▲▼▶◀ buttons. To confirm the item you wish to play/view press [OK] button.
- 2) Select the drive you require.(If your drive only has 1 partition you will only see 1 item).
- 3) You can now access the item. Press OK to view.
- 4) While viewing you control the item using (Fig A) or by pressing (i) and using ▲▼▶◀ and (OK).

Tip: If you experience a playback issue, please ensure the files being used are the correct format (example - the picture plays but no sound)

For the best performance, do not use USB extension cable. See technical specification page for compatible file types.

1)

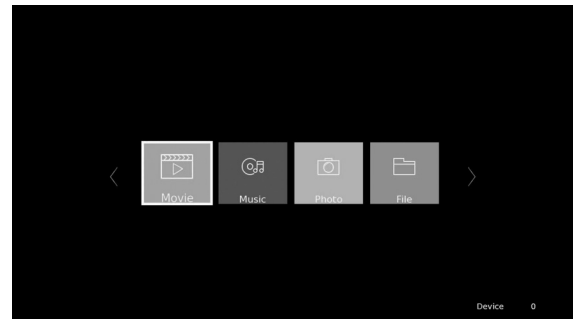

2)

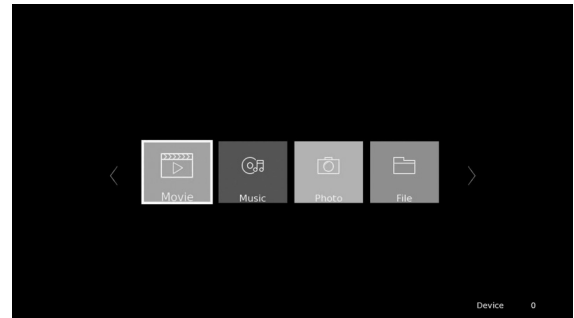

3)

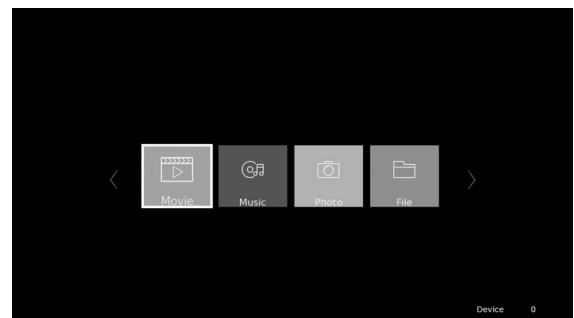

4)

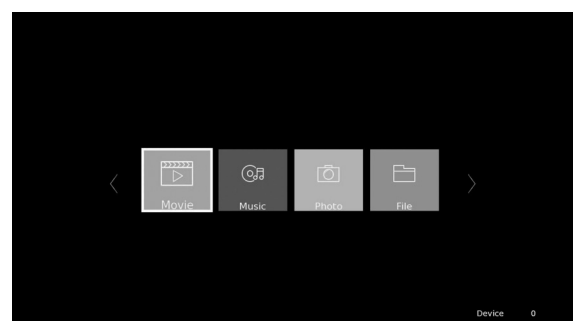

Fig A



If you require any technical guidance or find that your TV is not operating as intended, a simple solution can often be found in the **Troubleshooting** section of these instructions.



or online at www.argos-support.co.uk If you still require further assistance, call one of our experts on **0330 024 0805**. (Calls are charged at the standard rate of your network provider).







Product support

6

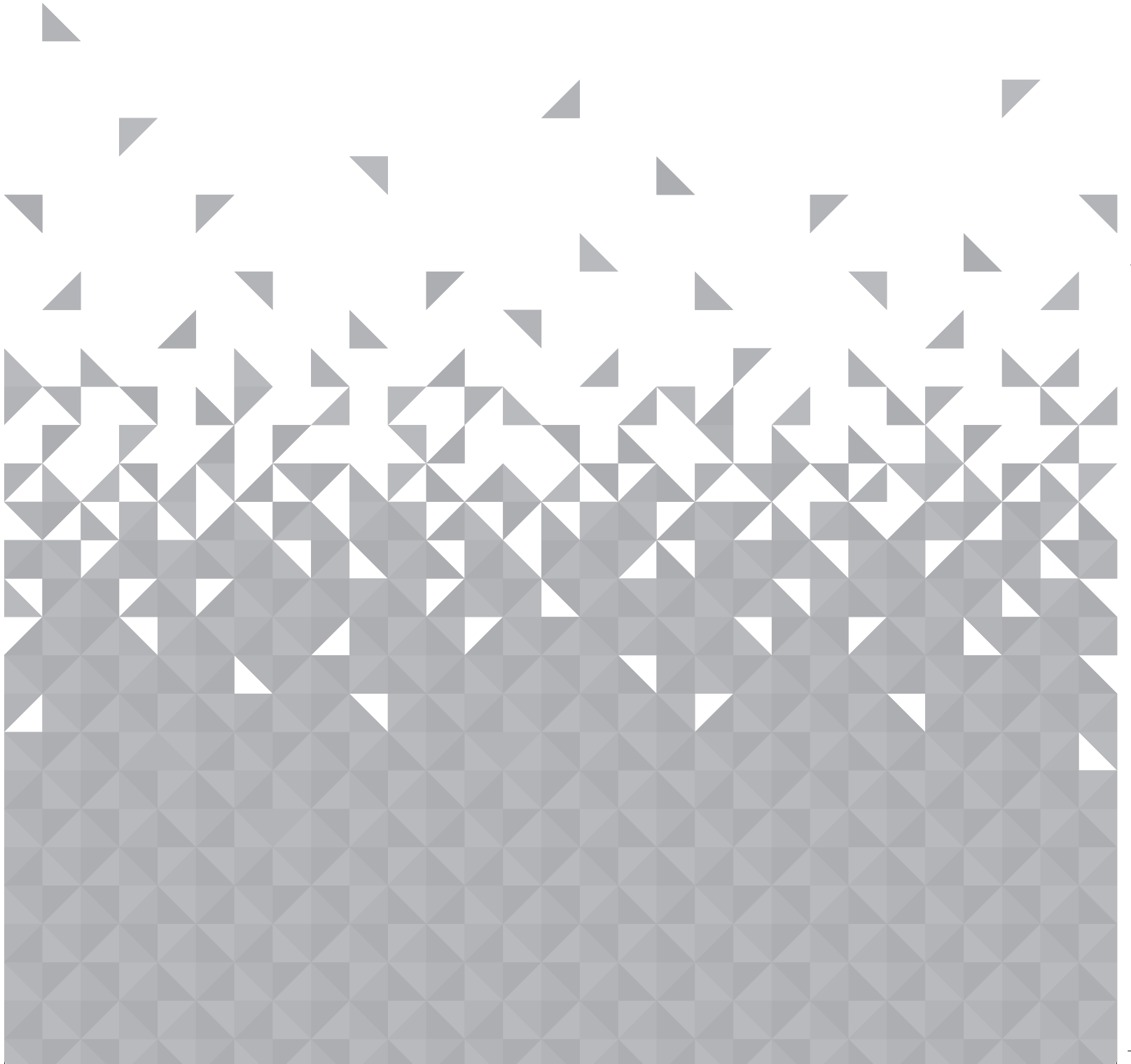

Product support

Help is always at hand

Connecting a sky digital set top box

Using a Sky Remote or a Universal Remote to operate your TV

Sky Remote Control - If you wish to use your Sky remote to operate the basic functions of your TV, you need to program a 4 digit code into it. Please note - you will need a Sky Revision 9 remote control (or later). If you wish to upgrade/replace your existing Sky remote control to the latest version, you can do so on our website.

Universal Remote Control - If you wish to use a Universal remote control to operate your TV, please refer to the website for a full list of codes. (Please note we only have codes for One for All branded remote controls, if you have an alternative brand of Universal remote, please refer to the manufacturer for the code).

Connecting your TV to your Sky box (when both the TV and Sky Box are located in the same room)

Option 1)

Depending on your Sky Box & TV model, connect either by SCART or HDMI cables (available separately).

If connecting by SCART, select the 'Input source' on the TV as SCART. If your TV model does not have SCART, please refer to the 'Connections' pages in this user guide for alternative ways to connect.

If connecting by HDMI, select the 'Input source' on the TV as HDMI (if the TV has more than 1 HDMI port, ensure you select the input source to match the HDMI numbered port on the rear of the TV).

If you wish to use your Sky remote to operate the TV's functions, you will need a Sky remote control (Revision 9 or later) and you will need to program a 4 digit code into it.

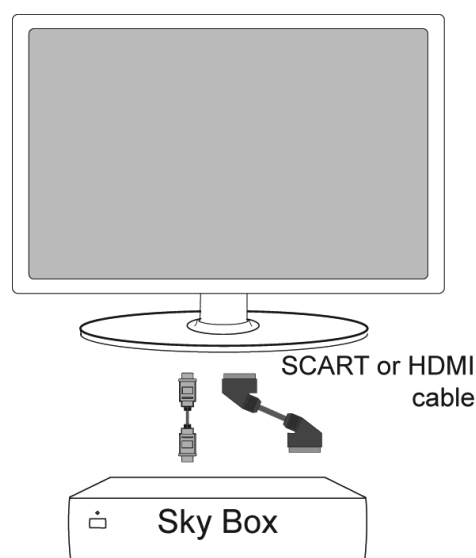

If you require any technical guidance or find that your TV is not operating as intended, a simple solution can often be found in the **Troubleshooting** section of these instructions.

Product support

Help is always at hand

Connecting your TV to your Sky box (when your Sky box is located in a different room to the TV)

Option 2)

Please note, if you are adding a 'Magic Eye/TV Link' to your system so that you can use your Sky remote control to change the Sky channel in the room where the 2nd TV is located, please refer to the instructions included with the TV link/magic eye in order to ensure the RF or RF2 output on your Sky box is powered on. (The red LED light on the TV link/magic eye will light up if the RF/RF2 output is correctly set up) If you do not have the instructions that came with the TV link/magic eye, instructions on how to do it can be found on our website.

- 1)** To tune the TV to the Sky box, on the 2nd TV, select the 'Analogue' input source.
- 2)** Select the channel that you wish to store the Sky box/channel on. (If you do not use channels 1-5 because you no longer have analogue terrestrial channels after digital switchover, you may choose to select channel 1 to store the Sky box/channel, if you still have and use analogue channels 1-5, you may for example decide that channel 6 is the best option for you)
- 3)** Press the corresponding number on the remote control to select the desired analogue channel chosen as per point 2 above.
- 4)** On the TV remote control, press Menu. Now navigate through the menus to select Manual Tuning or Analogue Manual Tuning (refer to the Tuning/Channel menu section of this user guide if necessary)
- 5)** Manually tune in the channel (usually, the Sky box is at a frequency between 800Mhz and 850Mhz) once the Sky box/channel is found, press 'OK' to store it. If you wish to use your Sky remote to operate the TV's functions, you will need a Sky remote control (Revision 9 or later) and you will need to programme a 4 digit code into it.

If you wish to use your Sky remote to operate the TV's functions, you will need a Sky remote control (Revision 9 or later) and you will need to programme a 4 digit code into it.

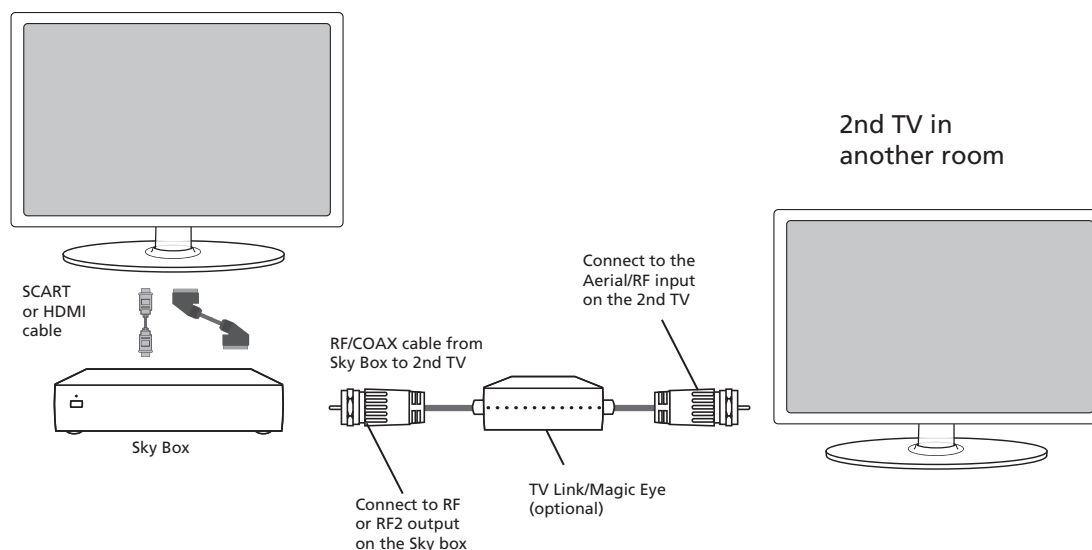

or online at www.argos-support.co.uk If you still require further assistance, call one of our experts on **0330 024 0805**. (Calls are charged at the standard rate of your network provider).

Other information

Helpful technical information

Frequently asked questions

General	I would like to have louder sound by connecting additional speakers.	<ol style="list-style-type: none"> 1) Use the 3.5mm headphone output and a 3.5mm to phono cable (available separately) to connect to an amplifier/surround sound system. Please note this will deactivate the TV's built in speakers. 2) Connect a COAX cable from the TV's COAX output to your amplifier/surround systems COAX input.
General	Why are some options in the menu unavailable and greyed out.	Some options are only available in certain sources, i.e. HDMI. They are unavailable in the other sources where they have no affect.
General	Can I stop my TV automatically turning off after 4hrs?	Yes, in the 'Time' menu settings, scroll down to Auto standby and select OFF.
TV	I have tuned in Digital TV but I am not receiving any or all of the channels and/or the channels I receive are breaking up.	<ol style="list-style-type: none"> 1) Check you are in an area that can receive Freeview/Saorview, visit www.freeview.co.uk or www.saorview.ie 2) Check you are using an aerial that is able to receive a good digital signal. In most cases, you will need an outdoor digital hi-gain/wideband aerial. In areas that have excellent digital coverage, you may be able to use a loft type aerial but it is highly likely that you will also need to connect a booster between the back of the TV and the TV aerial wall socket. Unfortunately, to receive a good enough digital signal, it is not possible to use a portable/indoor type aerial.
TV	I have re-tuned my television but when I switch it off it is not storing the channels.	<p>If the TV does not save the channels when you power it off, it's likely the channel database has become corrupt.</p> <ol style="list-style-type: none"> 1) Turn off the TV. 2) Remove the RF/Aerial cable from the rear of the TV and then turn the TV back on again. 3) Using the remote control, press Menu followed by 8-8-8-8 to enter the initial setup/first time installation menu. 4) Press OK (let the TV run the full tuning process). 5) Once completed, turn off the TV, reconnect the RF/Aerial cable then turn the TV back on again. 6) Repeat steps 3 & 4.
VCR/DVD Recorder	I have connected the TV to my VCR or DVD Recorder via SCART but it is not recording.	In addition to connecting via SCART, you should connect the aerial cable from the wall socket to your VCR/DVD Recorder and another aerial cable from the VCR/DVD Recorder to the TV.
Game Consoles	I have connected my Playstation/Xbox to the TV via HDMI, but I am not receiving any pictures or sound on my Television.	<ol style="list-style-type: none"> 1) Ensure the TVs' source is set to HDMI. 2) Check your settings on your Playstation/Xbox are as per the Playstation/Xbox instruction manual.

If you require any technical guidance or find that your TV is not operating as intended, a simple solution can often be found in the **Troubleshooting** section of these instructions.

Product support

Help is always at hand

Frequently asked questions

Game Consoles	I have connected my Playstation/Xbox to the TV via Component cables (red, green & blue) but I am not receiving any sound.	Component cables only provide HD pictures. For the sound you will need to connect the red & white audio cables on the Playstation/Xbox to the red & white phono inputs (or mini AV input where fitted) on the rear of the TV. Please refer to the 'Connections' pages.
System Lock	I have changed the password on the television and now forgotten it.	There is a master password of 4711, to gain access to the TV menu and reset the normal password.
USB Mode	I have inserted a USB Memory Key, but the TV does not recognise it.	Ensure the USB Memory Key is formatted to type FAT32.
USB Mode	Using a USB portable hard drive / larger than 32GB.	If you wish to use a portable hard drive larger than 32GB, please note that it must be formatted to the FAT32 file system in order to operate on this TV. Windows XP/Vista computers are only capable of formatting up to 32GB, therefore, you will need a software programme/utility to format larger hard drives. Please refer to the website, www.umc-uk.co.uk , for more information.
Freeview HD	I cannot access all Freeview channels	Some data channels for Freeview can only be obtained when the TV receives an internet connection.

or online at www.argos-support.co.uk If you still require further assistance, call one of our experts on **0330 024 0805**. (Calls are charged at the standard rate of your network provider).

Product support

Help is always at hand

Technical specification

Product fiche

Trademark	Bush
Model ID	55/148F
Energy efficiency class	A +
Visible screen size (diagonal)	139 cm / 55 inches
On mode power consumption	85.0 W
Annual energy consumption *1	124 kWh
Standby power consumption *2	<0.50 W
Off mode power consumption	0 W
Screen resolution	1920 (H) x 1080 (V)
*1: Energy consumption XYZ kWh per year, based on the power consumption of the television operating 4 hours per day for 365 days. The actual energy consumption will depend on how the television is used.	
*2: When the TV is turned off with the remote control/standby button and no function is active.	

Additional Technical Information	
RF	75 ohm Antenna / Analog / DVB
Video Inputs	3 x HDMI, 1 x USB, 1 x Mini Composite/Video, 1 x Mini Component/YPbPr, 1 x VGA/PC,
Sound Inputs	1 x shared audio for Composite/Video & Component/YPbPr, 1 x 3.5mm jack for PC audio input
Sound Outputs	1 x Digital Optical Audio output, 1 x 3.5mm Headphone
Speaker / Amplifier Watts (RMS)	2 x 10W / 2 x 8W
Dimensions including stand (mm)	1259 W x 795 H x 254 D
Net weight	15 kgs
Energy Consumption Info	
Voltage and power consumption	110-240v 50 / 60Hz 85 / 110 / 150W (ecomode/standard/max) EEI - A+ (Energy Rating)
Wallmounting VESA	200 x 200 (mm)

If you require any technical guidance or find that your TV is not operating as intended, a simple solution can often be found in the **Troubleshooting** section of these instructions.

Product support

Help is always at hand

Technical specification

Compatible files in USB Mode

Media	File Ext.	Video Decoder		Remark
		Video	Audio	
Movie	.mpg/.mpeg /.dat	MPEG-1, MPEG-2	MP3, WMA, AAC, LPCM	Max Solution: 1920×1080 Max Data Rate: 40 Mbps
	.ts/.trp/.tp/. m2ts	MPEG-2, H.264,VC1,AVS		
	.vob	MPEG-2		
	.mp4	MPEG-4, Xvid, H.264		
	.rm/.rmvb	Rm codec		
	.mkv	MPEG-1, MPEG-2, MPEG-4, H.264		Max Solution: 640×480 Max Data Rate: 10 Mbps
	.avi	MPEG-2, MPEG-4, Xvid, H.264		
	Motion JPEG	JPEG		
	.asf,wmv	VC1		
.flv/.swf	H.264, AVC, Sorenson H.263	Max Solution: 1920×1080 Max Data Rate: 40 Mbps		
Music	.mp3	--	MPEG1/2 (Layer1, Layer2, Layer3)	Sample Rate: 16KHz~48KHz BitRate: 32K~448Kbps
	.wma/.asf	--	WMA	BitRate: 128Kbps~320Kbps Sampling rate : 8KHz-48KHz
			WMA pro	BitRate: <768Kbps Sampling rate : ~96KHz
	.ogg	--	OGG	Sample Rate: ~48KHz
	.m4a/.aac	--	AAC HEAAC	Sample Rate: 8K~48KHz Bit Rate: 24K~384Kbps
Photo	.jpg/ .jpeg	Progressive JPEG		Max Resolution: 1024×768
		Baseline JPEG		Max Resolution: 1920×8×1088×8
	.bmp	BMP		Max Resolution: 9600×6400
	.png	Non-Interlaced		Max Resolution: 9600×6400
		Interlaced		Max Resolution: 1200×800

or online at www.argos-support.co.uk If you still require further assistance, call one of our experts on 0330 024 0805. (Calls are charged at the standard rate of your network provider).

Product support

Help is always at hand



Call us now and activate your 12 month guarantee

Thank you for choosing Bush. Your new product is guaranteed against faults and breakdowns for 12 months. Don't forget to register it with us today so we can provide you with our best possible after-sales service and useful updates.

www.bushregistration.co.uk

FREEPHONE*

0800 597 8548

Lines are open 8am - 8pm, 365 days a year. *Calls may be recorded and monitored.

Your Bush Guarantee

This product is guaranteed for twelve months from the date of original purchase. Any defect that arises due to faulty materials or workmanship will be repaired free of charge (or if applicable the product will be replaced or the purchase price refunded) where possible during this period by the dealer from who your purchased the unit.

The guarantee is subject to the following provisions:

- The guarantee does not cover accidental damage, misuse, cabinet parts, knobs or consumable items.
- The product must be correctly installed and operated in accordance with the instructions contained in the manual.
- It must be used solely for domestic purposes. The guarantee will be rendered invalid if the product is re-sold or has been damaged by inexpert repair.
- Specifications are subject to change without notice.
- Bush disclaim any liability for loss or damage arising from the breakdown of the product.
- This guarantee is in addition to and does not diminish your statutory or legal rights.

Important Data Protection Information

If you provide us with information about another person, you confirm that they have appointed you to act for them, to consent to the processing of their personal data including sensitive personal data and that you have informed them of our identity and the purposes (as set out in the Important Data Privacy notice displayed overleaf) for which their personal data will be processed.

You are entitled to ask for a copy of the information we hold about you (for which we may charge a small fee) and to have any inaccuracies in your information corrected.

For quality control and training purposes, we may monitor or record your communications with us.

If your personal details change, if you change your mind about any of your marketing preferences or if you have any queries about how we use your information, please let us know by contacting our Data Protection Officer, Domestic & General, Leicester House 17 Leicester Street, Bedworth, Warwickshire CV12 8JP.

Guarantor: Argos Limited - 489 - 499 Avebury Blvd. - Milton Keynes - MK9 2NW



BUSH

Contact:

www.umc-uk.co.uk

Helpline: 0330 024 0805

