

newWORLD

Instruction manual

Dishwasher
NWLC15FSBC

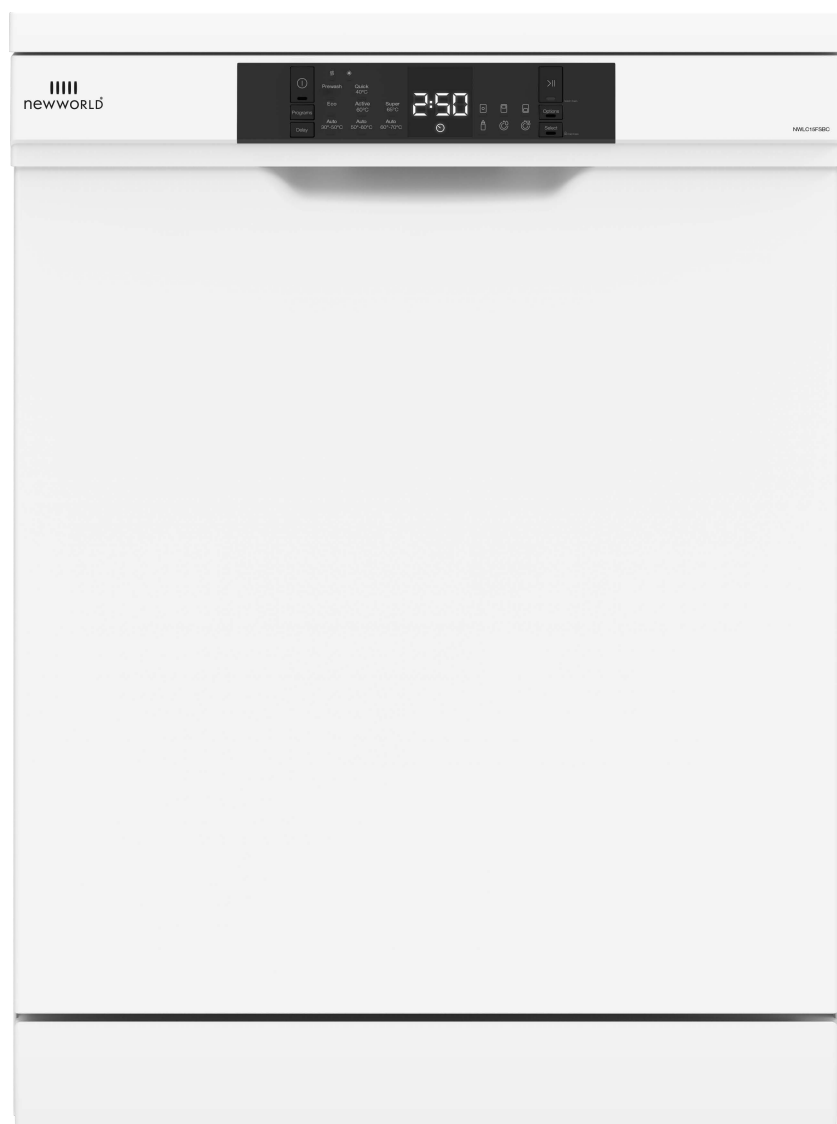

You'll soon be enjoying your new Dishwasher.

It all begins here, with your instructions. Don't worry, there's nothing too technical coming up. Just simple, step-by-step guidance to get you up and running quickly. Sound good? Then let's get started.

Help and Guidance

We're here to help you get the most from your Dishwasher. Should you require any guidance, a simple solution can often be found online at:

www.newworldassist.co.uk

If you still require further assistance, call one of our experts on **0333 305 2263**.

If you require any technical guidance or find that your product is not operating as intended, a simple solution can often be found in the **Troubleshooting** section of these instructions, or online at www.newworldassist.co.uk. If you still require further assistance, call one of our experts on **0333 305 2263**.

Contents

1 Safety information

Safety information 6

2 Getting to know your Dishwasher

Ready? Let's begin 10

Accessories 13

3 Installing your Dishwasher

Installation requirements 16

Connections (electrical, water) 17

4 Functions

Functions 20

5 Using your Dishwasher

First use of Dishwasher 24

Standard and advanced functions/use 25

6 Care and Maintenance

Cleaning 28

Maintenance actions 28

Technical specifications 29

7 Product support

Troubleshooting 32

Help and assistance 34





Declaration of conformance to product standards 35

Disposal 35

Guarantee 36

Safety information

1

Icon	Type	Meaning
	WARNING	Serious injury or death risk
	RISK OF ELECTRIC SHOCK	Dangerous voltage risk
	FIRE	Fire risk
	CAUTION	Injury or property damage risk
	IMPORTANT / NOTE	Operating the system correctly



Safety information

Important - Please read these instructions fully before installing or operating. Keep this manual for future reference.

Before use

- Carefully read all instructions before using your appliance and keep this manual for future reference.
- Check the machine and its packaging for any damage. If the supply cord is damaged, it must be replaced by the manufacturer, their service agent or similarly qualified persons in order to avoid a hazard.
- Unwrap the packaging as indicated and dispose of it according to the rules provided.
- Packing materials may be dangerous to the children. Please keep all packing materials (plastic bags, foams etc) far away from children.
- This appliance can be used by children aged from 8 years and above, and by persons with reduced physical, sensory or mental capabilities or lack of experience and knowledge if they have been given supervision or instruction concerning the use of the appliance in a safe way and understand hazards involved. Children should not play with the appliance. Cleaning and user maintenance shall not be done by children without supervision.
- Children should be supervised to ensure that they do not play with the appliance. There may be some residue left in the machine after washing. Keep children away from the machine when it is open.
- Ensure old machines do not threaten child safety. Children can lock themselves in old machines. To prevent such a situation, break the door lock and cut the mains cable..
- Only original spare parts should be used with the machine.
- Check the heat-resistance of plastic items before washing them in the machine.
- Do not put unsuitable items for dishwashing into the machine and do not over-fill any basket above its capacity.
- Our company will not be responsible for any deformation inside of the machine due to misuse.

WARNING: Some dishwasher detergents are strongly alkaline. They can be extremely dangerous if swallowed. Avoid contact with the skin and eyes and keep children away from the dishwasher when the door is open. Check that the detergent receptacle is empty after completion of the wash cycle.

Installation Warnings

- Choose a suitable and safe place to install your machine.
- Follow the instructions on installing and connecting the machine.
- Unplug the machine before installation.
- Machine should be installed by authorised service agent or similarly qualified persons only.
- Check whether the indoor electrical fuse system is connected according to regulations.
- All electrical connections must match the values on the plate
- Ensure the machine does not stand on the electrical supply cable.
- NEVER use an extension cord or a multiple socket connection.
- The plug should be accessible after the machine is installed.
- After installation, run your machine unloaded for the first time.
- The machine MUST not be plugged in during positioning.
- Always use the plug supplied with your machine.
- The machine's electrical cable should be replaced in case of a damage by an authorised service agent or similarly qualified person to prevent a hazard.

If you require any technical guidance or find that your product is not operating as intended, a simple solution can often be found in the **Troubleshooting** section of these instructions, or online at www.newworldassist24.co.uk. If you still require further assistance, call one of our experts on "03 305 2263".















Safety information

Important - Please read these instructions fully before installing or operating your Dishwasher

During Use

This machine is for domestic use only, do not use it for other purposes. Commercial use will void the guarantee.

-  • Do not stand, sit or place loads on the open door of the dishwasher.
 -  • Only use detergents and rinse aids produced specifically for dishwashers. Our company is not responsible for any damage that may occur due to misuse.
 -  • Do not drink water from the machine.
 -  • Due to the danger of an explosion, do not place any chemical dissolving agents into the machine's washing section.
 -  • Do not open the door while the machine is in operation, hot water may spill out. Safety devices ensure the machine stops if the door is opened.
 -  • The machine door should not be left open. It may present a trip hazard or cause accidents.
 -  • Place knives and other sharp objects in the cutlery basket in a blade-down position.
 -  • For safety, disconnect the plug once a program has finished.
 -  • To avoid an electric shock, do not unplug the machine with wet hands.
 -   • Pull the plug to disconnect the machine from the mains, never pull on the cord.
-   • For models with the automatic door-opening system, when the EnergySave option is active, the door will open at the end of a program. To prevent damage to your dishwasher, do not force the door close after 1 minute of auto-open. For effective drying, keep the door open for 30 minutes after a programme is complete. Do not stand in front of the door after the auto-open signal sounds.
 -  • In the case of a malfunction, repair should only be performed by authorised service personnel. Otherwise, the warranty will be void.
 -   • Before repair work, the machine should be disconnected from the mains. Do not pull the cable to unplug the machine. Switch off the water tap.
 - Operation at a low voltage will cause a decline in performance levels.
 - Do not use this appliance if there are any missing or damaged parts.
 - Do not attempt to repair the appliance yourself. contact the manufacturer, their approved service agent or the customer helpline on: 0333 305 2263.

If you require any technical guidance or find that your product is not operating as intended, a simple solution can often be found in the **Troubleshooting** section of these instructions, or online at www.newworldassist.co.uk If you still require further assistance, call one of our experts on "0333 305 2263."

This page is left intentionally blank

Getting to know your Dishwasher

2



Getting to know your Dishwasher

You'll be up and running in no time

Ready? Let's begin...

Please read these instructions carefully. They contain important information which will help you get the best from your Dishwasher and ensure safe and correct installation and operation.

If you require any further assistance, our technical experts are happy to help. For full details, refer to the product support section at the end of these instructions.

If you require any technical guidance or find that your product is not operating as intended, a simple solution can often be found in the **Troubleshooting** section of these instructions, or online at www.newworldassist.co.uk If you still require further assistance, call one of our experts on "03 305 2263".

Getting to know your Dishwasher

You'll be up and running in no time

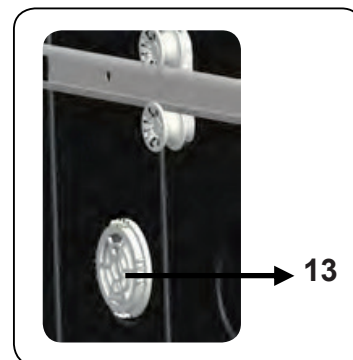
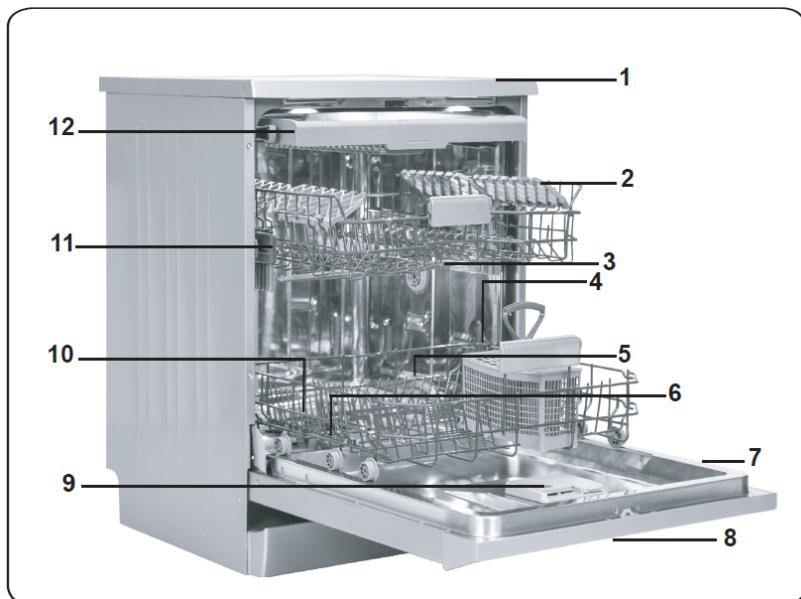

1. Worktop
2. Upper Basket with racks
3. Upper Spray Arm
4. Lower Basket
5. Lower Spray Arm
6. Filters
7. Rating Plate
8. Control Panel
9. Detergent and Rinse-aid Dispenser
10. Salt Dispenser
11. Upper Basket Track Latch
12. Cutlery Basket
13. Turbo Drying Unit: This system provides better drying performance

Capacity	15 place settings
Dimensions	
Height	844(mm)
Width	598(mm)
Depth	595(mm)
Net weight	44 (kg)
Operating voltage / frequency	220-240V 50 (Hz)
Total current	10(A)
Total power	1900(W)
Water supply pressure	Maximum: 1 (Mpa) Minimum: 0.03 (Mpa)

If you require any technical guidance or find that your product is not operating as intended, a simple solution can often be found in the **Troubleshooting** section of these instructions, or online at www.newworldassist24.co.uk. If you still require further assistance, call one of our experts on "03 305 2263".

Getting to know your Dishwasher

You'll be up and running in no time

Model	Capacity	Power	Energy Class	Drying Class
NWLC15FSBC	15 pcs	1900W	A++	A

Accessories

This machine includes the below accessories, please install these parts before operating.

- Water Inlet Hose x1
- Drain Hose x1

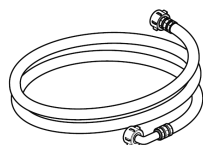

Installing your Dishwasher

3



Installing your Dishwasher

Bringing it all together

Positioning your Dishwasher

When positioning the machine, place it in an area where dishes can be easily loaded and unloaded. Do not put the machine in an area where the ambient temperature falls below 0°C.

Read all warnings located on the packaging before removing the packaging and positioning the machine.

Place the machine close to a water tap and drain. Take into consideration that the connections will not be altered once the machine is in position.

Do not hold the machine by its door or panel.

Leave an adequate distance around the machine to allow ease of movement when cleaning.

 Ensure the water inlet and outlet hoses are not squeezed or trapped and that the machine does not stand on the electrical cable while positioning.

Adjust the feet so the machine is level and balanced. The machine should be placed on flat ground otherwise it will be unstable and the door of the machine will not close properly.

Water connection

We recommend fitting a filter to your water inlet supply in order to prevent damage to your machine due to contamination (sand, rust, etc.) from indoor plumbing. This will also help prevent yellowing and deposit formation after washing.

Water Inlet Hose





 **WARNING:** Use the new water inlet hose supplied with your machine, do not use an old machine's hose.

 **WARNING:** Run water through the new hose before connecting.

 **WARNING:** Connect the hose directly to the water inlet tap. The pressure supplied by the tap should be a minimum of 0.03MPa and a maximum of 1 MPa. If the pressure exceeds 1MPa, a pressure relief valve must be fitted between the connection.

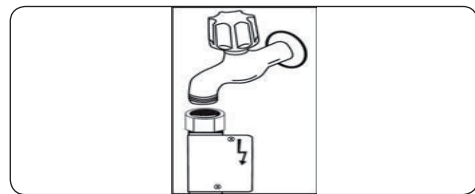
 **WARNING:** After the connections are made, turn the tap on fully and check for water leaks. Always turn off the water inlet tap after a wash program has finished.



 **WARNING:** An Aquastop water spout is available with some models. Do not damage it or allow it to become kinked or twisted.

Installing your Dishwasher

Bringing it all together

Drain Hose Connection

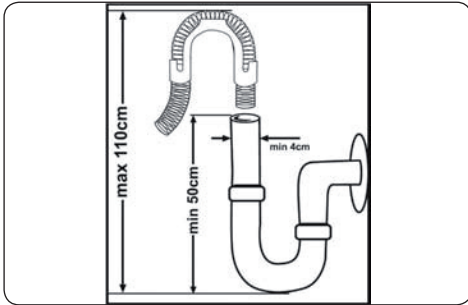

Connect water drain hose directly to water drain hole or to the sink outlet spigot. This connection should be minimum 50cm and maximum 110cm from floor plane.

IMPORTANT: Items will not wash properly if a drain hose longer than 4m is used.

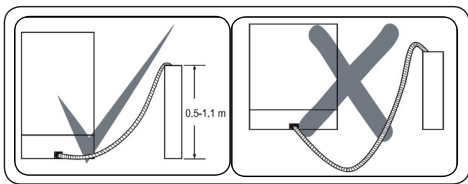

Electrical Connection

Machine should be installed by authorised service agent or similarly qualified persons only.

! WARNING: Your machine is set operates at 220-240V. If the mains voltage supply to your machine is 110V, connect a transformer of 110/220V and 3000 W between the electrical connection.

! **⚡** The earthed plug of the machine must be connected to an earthed outlet supplied by suitable voltage and current.

! **⚡** In the absence of earthing installation, an authorised electrician should carry out an earthing installation. In the case of use without earthing installed, we will not be responsible for any loss of use that may occur.

! The indoor fuse current value should be 10-13A.

Installing your Dishwasher

Bringing it all together

Fitting the machine undercounter

If you wish to fit your machine undercounter, there must be sufficient space to do so and the wiring-plumbing must be suitable to do so (1). If the space under the countertop is suitable for fitting your machine, remove the worktop as shown in the illustration (2).

! WARNING: The countertop, of which the machine will be placed under, must be stable in order to prevent imbalance.

The top panel of the dishwasher must be removed to fit the machine under the counter.

To remove the top panel, remove the screws that hold it on, located at the rear of the machine. Then, push the panel 1cm from the front towards the rear and lift it. Adjust the machine feet according to the slope of the floor (3).

Fit your machine by pushing it under the counter, taking care not to crush or bend the hoses (4).

! WARNING: After removing the top panel of your dishwasher, the machine should be placed in a space of the dimensions shown in the following figure.

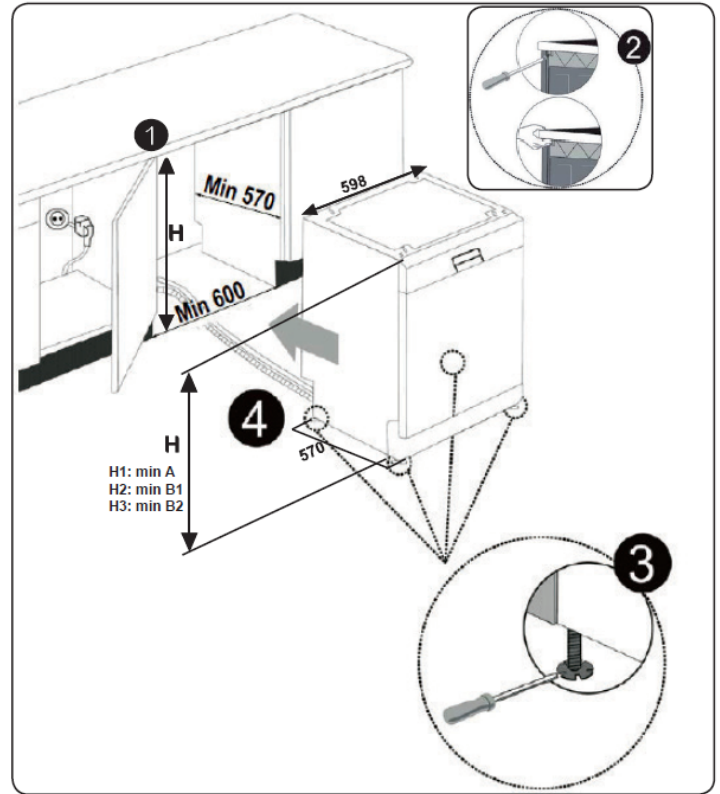

	A	B	
	All Products	B ₁	B ₂
Product's Height (±2 mm)	820 mm	830 mm	835 mm

A: If there is no felt on the top of the product, you should take into account this product height

B1: If there is felt on top of the product with 2nd basket, you should take into account this product height.

B2: If there is felt on top of the product with 3rd basket, you should take into account this product height.

Functions 4



Functions

Simple everyday use

Programme Table

Programme	Duration (min)	Description
Prewash	15	To rinse dishes that you plan to wash later.
Quick 30'	30	For lightly soiled dishes and a quick wash.
Eco (Reference)	171	Standard programme for dishes which are used daily but are not heavily soiled.
Daily	94	For dishes which are used daily but are not heavily soiled.
Super 50'	50	A faster programme for dishes which are used daily but are not heavily soiled.
Auto Delicate	64-92	Automatic programme for delicate dishes which are not heavily soiled.
Auto Normal	100-121	Automatic programme for dishes which are not heavily soiled.
Auto Intensive	111-178	Automatic programme for heavily soiled dishes.



NOTE: THE PROGRAMME DURATION MAY CHANGE ACCORDING TO THE AMOUNT OF DISHES, THE WATER TEMPERATURE, THE AMBIENT TEMPERATURE AND SELECTED ADDITIONAL FUNCTIONS.

- Only use powder detergent for short programmes.
- To assist drying, we recommend slightly opening the door after a cycle is complete.

Functions

Simple everyday use

Control Panel

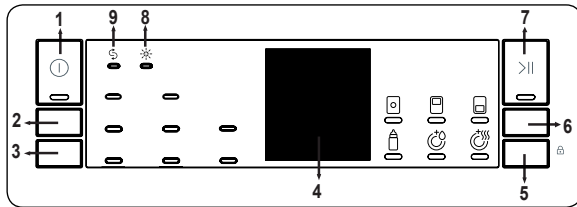

1. On/Off Button

Switch the machine on by pressing the On/Off button. The On/Off lamp lights as long as the machine is on.

2. Program Selection Button

Select a suitable programme by pressing the Programme button.

3. Delay Button

You can delay the start time of the programme for 1-2...24 hours by pressing the delay button (3) before the programme starts. If you want to change the delay time, first press the Start/Pause button and then the delay button to select a new delay time. To activate the new delay time, press the Start/Pause button. To cancel the delay, you need to switch to 0 hour by using the delay when the machine is paused.

4. Remaining Time Indicator

Programme flow can be monitored via the Wash, Rinse, Dry, End lamps and Remaining Time Indicator. The machine remains silent for about 40-50 minutes with respect to the flow of the programme you have selected.

5. Select Button

Options can be selected by pressing the Options button repeatedly. The chosen option will be indicated by a blinking LED. Select the option by pressing the Select button. The LED for the chosen option will then remain lit.

6. Options Button

If you have used an extra feature on the latest washing programme, this feature will remain active on the next washing programme. If you want to cancel this feature on the newly selected washing programme, press the options button to browse the options and press the select button to deactivate the related option or turn the machine off with the on/off button. If you would like to use an extra feature with a newly selected programme, select the desired function.

7. Start/Pause Button

Press the Start/Pause button to start the programme. The wash lamp turns on and the Remaining Time Indicator shows the programme duration. It also indicates the remaining time during the programme flow. If you open the door of your machine when the programme is running the duration of the programme pauses, and the Start/Pause led blinks.

8. Rinse Aid Indicator

When the rinse aid level is low, the rinse aid lack warning indicator turns on and you should fill the rinse aid chamber.

9. Salt Indicator

When there is insufficient softening salt, the salt lack warning indicator turns on and you should fill up the salt chamber.



NOTE: By selecting the half load option, three sorts of washing can be executed: both baskets, upper basket and lower basket. These options are ideal for smaller loads, allowing the dishwasher to perform smaller washes with reduced consumption.



NOTE: Select the Tablet option when using combined detergent that contains salt, rinse aid and extra functions.



NOTE: You may select Hygiene in order to obtain a more hygienic and a cleaner washing process by altering the water temperature and washing time of the programme you have selected.



NOTE: If the Rinse option is selected, washing-rinsing steps will be added into the selected programme, so you can ensure that your dishes will be extra clean and shiny.



NOTE: If the Drying lamp is on, extra heating and drying steps will be added into the selected programme, so your dishes will be dried more thoroughly.



NOTE: Child lock is activated/deactivated by pressing the select button (5) for about 3 seconds. When it is activated, all leds blink and "CL" is shown on the Re



NOTE: If you switch the machine to off position after selecting the delay time and the programme has started, the delayed time is cancelled.

Functions

Simple everyday use

Changing a programme

If you would like to change the programme when the machine is already running:

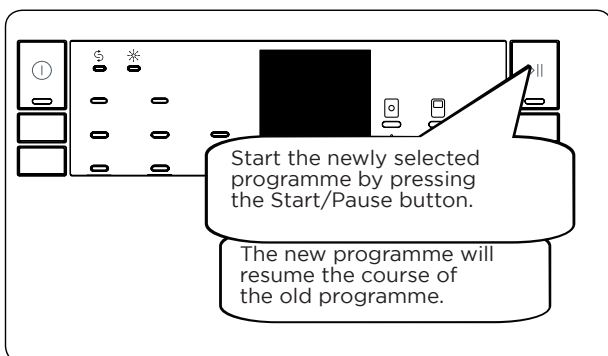
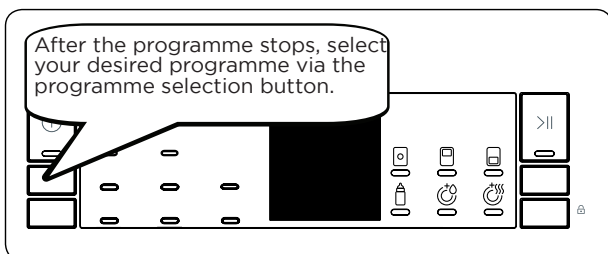
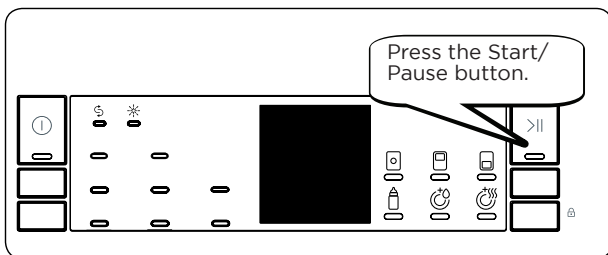

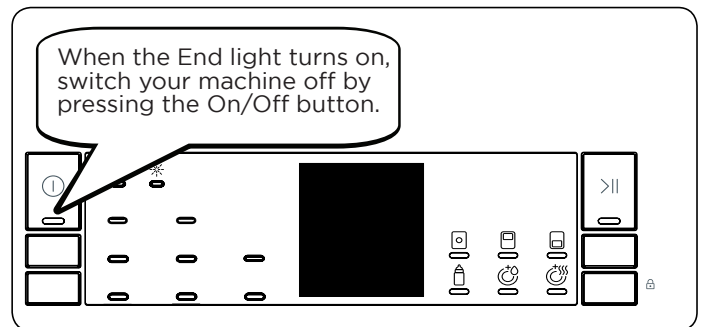
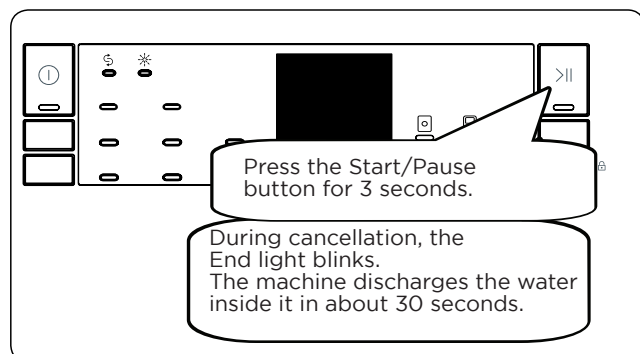

Cancelling a programme

If you would like to cancel a programme when it is running:

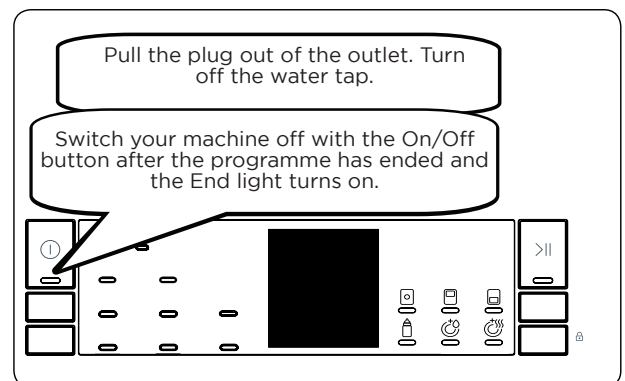

Switching the machine off



 NOTE: Do not open the door before the programme ends.

 NOTE: At the end of the washing programme, you can leave the door of your machine ajar to aid the drying.

 NOTE: If the door of machine is opened or the power is cut off during washing, the programme will continue when the door is closed or the power is restored.

Using your Dishwasher

5



Using your Dishwasher

Getting the most from your appliance

Before using your appliance

Preparing your Dishwasher for first use

Check whether the electricity and supply water specifications match the values indicated in the installation instructions for the machine.

Remove all packaging materials inside the machine.

Set the water softener level.

Fill the rinse aid compartment.

Fill the salt (If Available)

To fill with softener salt, open the salt compartment cap by turning it counter clockwise. (1) (2) At first use, fill the compartment with 1 kg salt and water (3) until it is almost overflowing. If available, using the funnel (4) provided will make filling easier. Replace the cap and close it. After every 20th-30th wash, add salt into your machine until it fills up (approx. 1 kg).

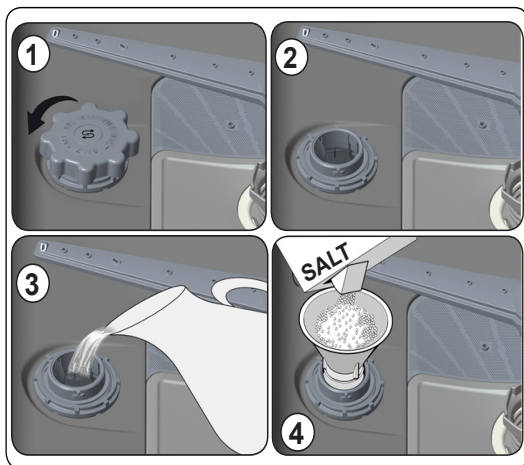

Fill the salt compartment with water the first time you fill the salt compartment only.

Use softener salt specifically produced for use in dishwashers.

When you start your dishwasher, the salt compartment is filled with water, therefore put the softener salt in prior to starting your machine.

If the softener salt has overflowed and you do not start the machine immediately, run a short washing program to protect your machine against corrosion.

Test Strip

Run water through tap (1min.)	Keep the strip in water(1sec)	Shake the strip.	Wait (1min.)	Set the hardness level of your machine.
				1 2 3 4 5 6

NOTE: Level is set 3 as default. If the water is well water or has a hardness level above 90 dF, we recommend that you use filter and refinement devices.

Water Hardness Table

Level	German dH	French dF	British dE	Indicator
1	0-5	0-9	0-6	L1 is shown on display.
2	6-11	10-20	7-14	L2 is shown on display.
3	12-17	21-30	15-21	L3 is shown on display.
4	18-22	31-40	22-28	L4 is shown on display.
5	23-31	41-55	29-39	L5 is shown on display.
6	32-50	56-90	40-63	L6 is shown on display.

Water Softener System

The dishwasher is equipped with a water softener which reduces the hardness in the mains water supply. To find out the hardness level of your tap water, contact your water company or use the test strip (if available)

Setting

- Turn on the machine by pressing On/Off button.
- Press Program button for at least 3" immediately after machine is turned on.
- Release Program button when "SL" is shown. Next, the last setting is displayed.
- Press Program button to set the desired level. At any pressure of program button hardness level is increased. Hardness level 1 returns after hardness level 6.
- The last selected water hardness level is stored in the memory by turning machine off with On/Off button.

If you require any technical guidance or find that your product is not operating as intended, a simple solution can often be found in the **Troubleshooting** section of these instructions, or online at www.newworldassist.co.uk. If you still require further assistance, call one of our experts on "03 305 2263".

Using your Dishwasher

Getting the most from your appliance

Before using the appliance

Detergent usage

Only use detergents specifically designed for domestic dishwashers.
Add the recommended amount of detergent for the selected programme to ensure the best performance.
Keep your detergents in cool, dry places out of reach of children.
See the detergent manufacturer's instructions for a further information.

Filling the detergent

Push the latch to open the dispenser and pour in the detergent.
Close the lid and press it until it locks in place. The dispenser should be refilled just before the start of each programme. If the dishes are heavily soiled, place additional detergent in the pre-wash detergent chamber.

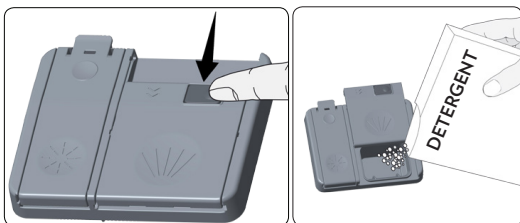

Using combined detergents

These products should be used according to the manufacturer's instructions.

Never put combined detergents into the interior section or the cutlery basket.

Combined detergents contain not only the detergent but also rinse-aid, salt replacement substances and additional components depending on the combination.

We recommend you do not use combined detergents in short programmes.

Please use powder detergents in such programmes.

If you encounter problems when using combined detergents, please contact the detergent manufacturer.

When you stop using combined detergents, make sure that water hardness and rinse aid settings are set to correct level.

Rinse-aid usage

Rinse-aid makes dishes sparkle and helps them to dry without spotting. Rinse-aid is required for stain-free utensils and clear glasses. Use only rinse-aid for domestic dishwashers.

Filling the rinse-aid and setting

To fill the rinse aid compartment, open the rinse-aid compartment cap. Fill the compartment with rinse aid to the MAX level and then close the cap. Be careful not to overfill the rinse aid compartment and wipe up any spills.

In order to change the rinse aid level, follow the below steps before turning on the machine:

- Push the programme button and hold it down.
- Turn on the machine.
- Hold down the programme button until "rA" disappears from the display. Rinse aid setting follows water hardness setting.
- The machine will display the last setting.
- Set the level by pushing the programme button.
- Switch off the machine to save the setting.
- The factory setting is "4".

If the dishes are not drying properly or are spotted, increase the level. If blue stains form on your dishes, decrease level.

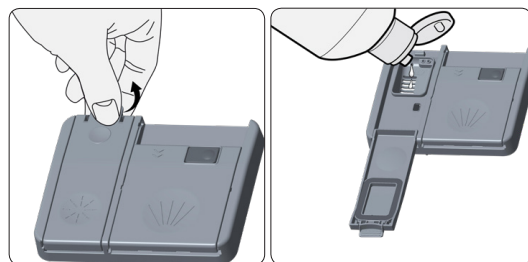

Level	Brightener Dose	Indicator
1	Rinse-aid not dispensed	r1 is shown on the display.
2	1 dose is dispensed	r2 is shown on the display.
3	2 doses are dispensed	r3 is shown on the display.
4	3 doses are dispensed	r4 is shown on the display.
5	4 doses are dispensed	r5 is shown on the display.

Using your Dishwasher

Getting the most from your appliance

Loading your Dishwasher

For best results, follow these loading guidelines.

We recommend that you place large items (pots, pans, lids, plates and bowls) which are heavily soiled in the lower basket.

The upper basket is designed for delicate and lighter dishware such as glasses, coffee and tea cups and saucers. Position the dishes so that they will not get moved by the spray of water.

Cutlery should be placed in the cutlery basket. Items should be loaded individually into the appropriate slots with their handles downwards. Long utensils should be placed horizontally on the baskets.

 **WARNING:** Take care not to obstruct the rotation of spray arms.

Recommendations

Remove any coarse residue on dishes before placing the dishes in the machine. Start the machine with full load.

NEVER overload the drawers or place dishes in the wrong basket.

 **WARNING:** Always place sharp utensils with the sharp point down and open utensils with their openings down.

Upper Basket

Height Adjustment

Turn the Rail Stop Clips, at the ends of the rails, to the sides to open them (as shown in the following image), then pull out and remove the basket. Change the position of the wheels, then reinstall the basket to the rail, making sure to close the Rail Stop Clips. When the upper basket is in the higher position, large items such as pans can be placed on the lower basket.

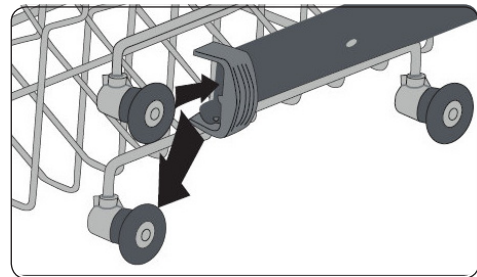
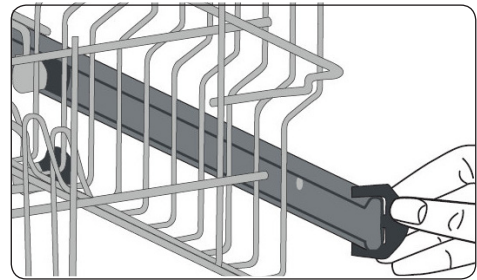

Height Adjustable Rack (peg type)

The height adjustable racks enable glasses and cups to be placed on or under the racks. The racks can be adjusted to 2 different heights. Cutlery and utensils can also be placed on the racks horizontally.

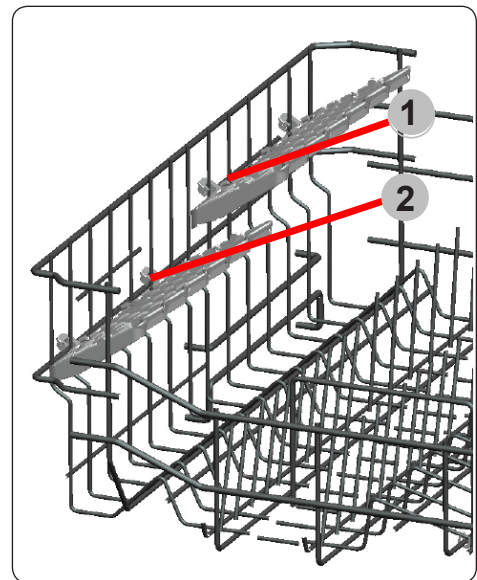

Four Folding Racks

The folding racks allow easier placement of larger items, such as pots and pans. Each section can be folded separately. The racks can be raised up, or folded down as shown in the images.

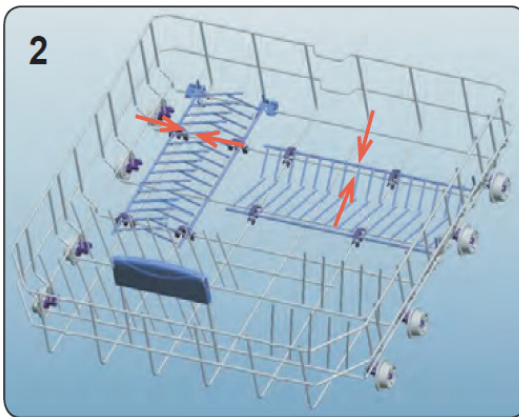
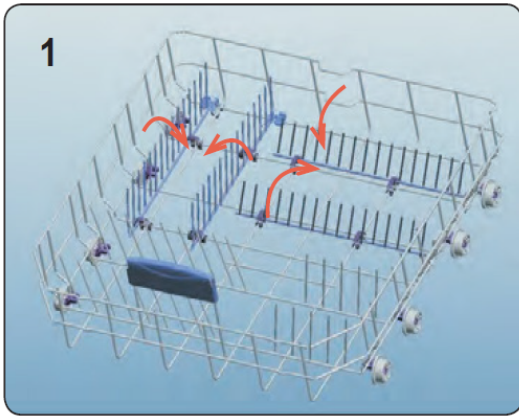

Alternative basket loads

Lower basket

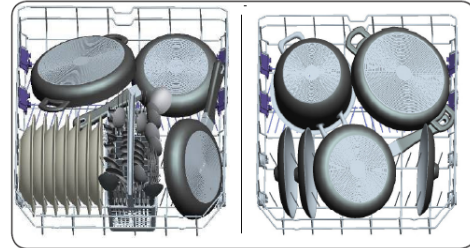

Upper basket

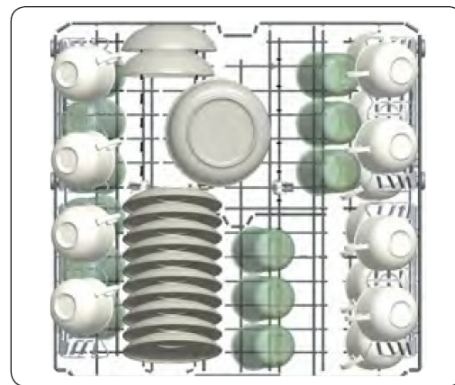

Upper Cutlery Basket

The upper cutlery basket is designed for the placement of large and small cutlery and utensils..



 **WARNING:** Knives and other sharp objects must be placed horizontally in the cutlery basket.

If you require any technical guidance or find that your product is not operating as intended, a simple solution can often be found in the **Troubleshooting** section of these instructions, or online at www.newworldassist24.co.uk If you still require further assistance, call one of our experts on "03 305 2263".

Incorrect loads

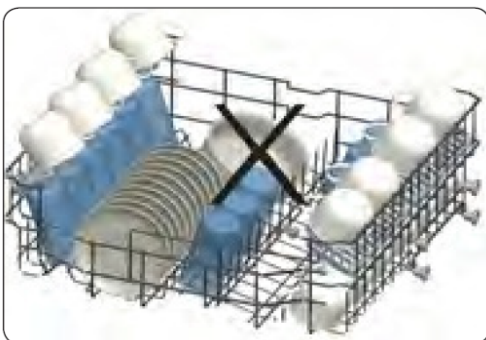
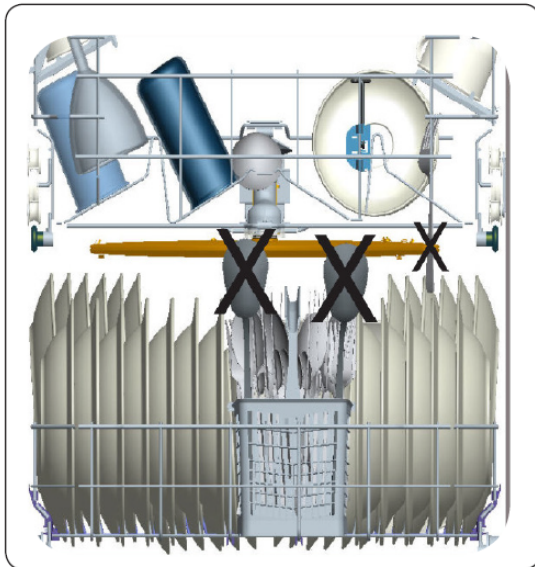
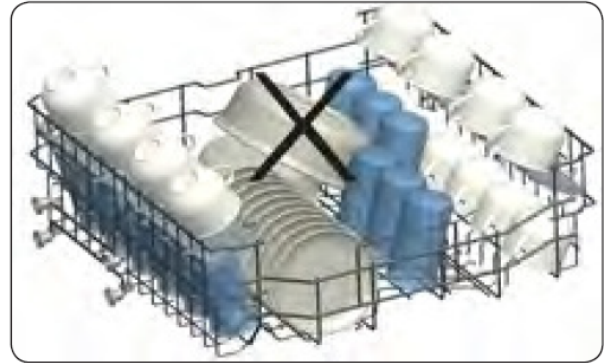
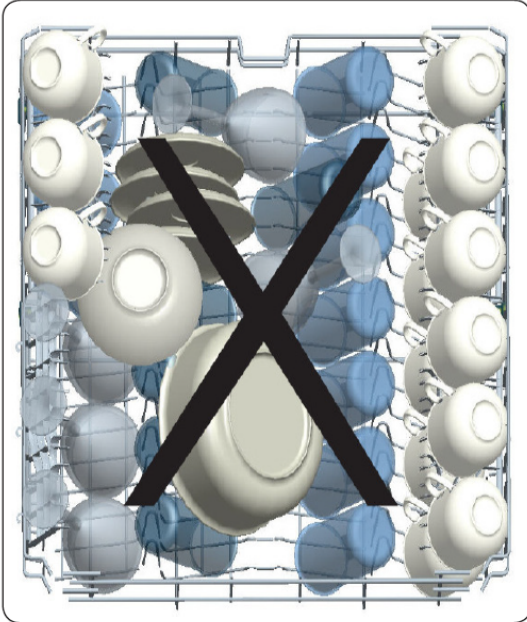

Unsuitable items for dishwashing

Cigarette ashes, candle leftovers, polish, paint, chemical substances, iron-alloy materials.

Forks, spoons and knives with wooden, bone, ivory or nacrecoated handles, glued items, items soiled with abrasive, acidic or base chemicals.

Temperature-sensitive plastics, copper or tin-coated containers.

Aluminum and silver objects.

Some delicate glasses, ornamental printed porcelains: some crystal items, adhered cutlery, lead crystal glasses, cutting boards, synthetic fibred items.

Absorbent items such as sponges or kitchen rugs.

IMPORTANT: In future, purchase dishwasher-proof kitchenware.

Important Note for Test Laboratories

For detailed information required for tests according to EN normatives and a softcopy of the manual, please send the model name and serial number to the following address: dishwasher@standardtest.info

If you require any technical guidance or find that your product is not operating as intended, a simple solution can often be found in the **Troubleshooting** section of these instructions, or online at www.newworldassist24.co.uk If you still require further assistance, call one of our experts on "03 305 2263".

Care and maintenance

6



Care and maintenance

Looking after your appliance

Cleaning

Cleaning your Dishwasher is important to maintain the machine's service life.

Oil and limescale may build up in your Dishwasher over time. If this occurs:

- Fill the detergent compartment but do not load any dishes. Select a programme which runs at high temperature and run the Dishwasher empty. If this does not clean your Dishwasher sufficiently, use a cleaning agent designed for use with dishwashers.
- Wipe the door seals regularly with a damp cloth to remove any accumulated residue.

Cleaning machine and filters

Clean the filters and spray arms at least once a week. If any food waste remains on the coarse and fine filters, remove them and clean them thoroughly with water.

- a) Micro Filter
c) Metal Filter

- b) Coarse Filter

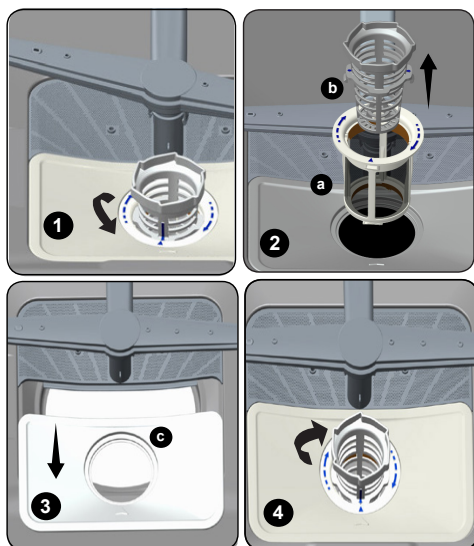

To remove and clean the filter combination, turn it counter clockwise and remove it by lifting it upwards (1). Pull the coarse filter out of the micro filter (2). Then pull and remove the metal filter (3). Rinse the filter with lots of water until it is free of residue. Reassemble the filters. Replace the filter insert, and rotate it clockwise (4).

- Never use your Dishwasher without a filter.
- Incorrect fitting of the filter will reduce the washing effectiveness.
- Clean filters are necessary for proper running of the machine.

Spray arms

Make sure that the spray holes are not clogged and that no food waste is stuck to the spray arms. If there is any clogging, remove the spray arms and clean them under water. To remove the upper spray arm undo the nut holding it in position by turning it clockwise and pulling it downwards. Make sure that the nut is properly tightened when refitting the upper spray arm.

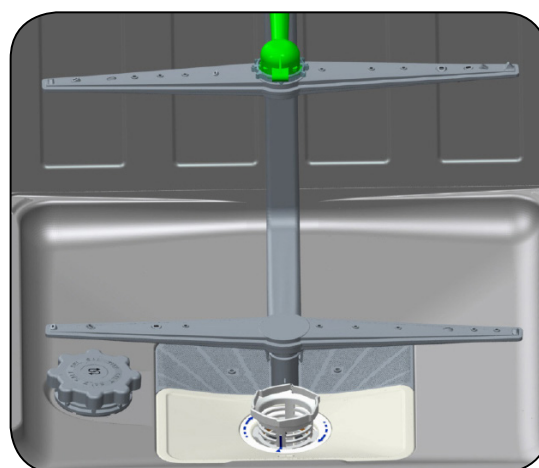

Care and maintenance

Looking after your appliance

Technical specifications

Supplier's trade mark	NEW WORLD
Supplier's model	NWLC15FSBC
Capacity of dishwasher	15
The energy efficiency class	A++
Annual energy consumption in kWh per year (AEc) (280 Cycle)*	270
Energy consumption (Et) (kWh per cycle)	0,94
Off-mode power consumption (W) (Po)	0,50
Left-on mode power consumption (W) (Pi)	1,00
Annual water consumption in litres per year (AWc) (280 Cycle)**	2520
Drying efficiency class***	A
Standard programme name****	Eco
Programme time for standard cycle (min)	171
Duration of the left-on mode (T ₁) (min)	-
Airborne acoustical noise emissions (dB(A) re 1 pW)	49
Freestanding/Built-in	Freestanding

* Energy consumption 270 kwh per year, based on 280 standard cleaning cycles using cold water fill and the consumption of low power modes. Actual energy consumption will depend on how the appliance is used.

** Water consumption 2520 litres per year based on 280 standard cleaning cycles. Actual water consumption will depend on how appliance is used.

*** Drying efficiency class A on a scale from G (least efficient) to A (most efficient).

**** The "Eco" is the standard cleaning cycle to which the information in the label and the fiche relates. This programme is suitable to clean normally soiled tableware and it is the most efficient programme in terms of combined energy and water consumption.

Product support

7



Product support

Help is always at hand

Troubleshooting

FAULT	POSSIBLE CAUSE	TROUBLESHOOTING
The programme does not start.	Your Dishwasher is not plugged in.	Plug your Dishwasher in.
	Your Dishwasher is not switched on.	Switch your Dishwasher on by pressing the On/Off button.
	Fuse blown.	Check your indoor fuses.
	Water inlet tap is closed.	Turn on the water inlet tap.
	Your Dishwasher door is open.	Close the Dishwasher door.
	Water inlet hose and machine filters are clogged.	Check the water inlet hose and machine filters and make sure they are not clogged.
Water remains inside the machine.	Water drain hose is clogged or twisted.	Check the drain hose, then either clean or untwist it.
	The filters are clogged.	Clean the filters.
	The programme is not finished yet.	Wait until the programme is finished.
Machine stops during washing.	Power failure.	Check mains power.
	Water inlet failure.	Check water tap.
Shaking and hitting noises are heard during a wash operation.	The spray arm is hitting the dishes in the lower basket.	Move or remove items blocking the spray arm.
Partial food wastes remain on the dishes.	Dishes placed incorrectly, sprayed water not reaching affected dishes.	Do not overload baskets.
	Dishes leaning each another.	Place dishes as instructed in the section on loading your dishwasher.
	Not enough detergent used.	Use the correct amount of detergent, as instructed in the programme table.
	Wrong wash programme selected.	Use the information in the programme table to select the most appropriate programme.
	Spray arms clogged with food waste.	Clean the holes in the spray arms with thin objects.
	Filters or water drain pump clogged or filter misplaced.	Check the drain hose and filters are correctly fitted.

If you require any technical guidance or find that your product is not operating as intended, a simple solution can often be found in the **Troubleshooting** section of these instructions, or online at www.newworldassist24.co.uk. If you still require further assistance, call one of our experts on "03 305 2263".

Care and maintenance

Looking after your appliance

FAULT	POSSIBLE CAUSE	TROUBLESHOOTING
Whitish stains remains on dishes.	Not enough detergent used.	Use the correct amount of detergent, as instructed in the programme table.
	Rinse aid dosage and/or water softener setting set too low.	Increase rinse aid and/or water softener level.
	High water hardness level.	Increase water softener level and add salt.
	Salt compartment cap not closed properly.	Check that the salt compartment cap is closed properly.
Dishes do not dry.	Drying option is not selected.	Select a programme with a drying option.
	Rinse aid dosage set too low.	Increase rinse aid dosage setting.
Rust stains form on the dishes.	Stainless-steel quality of the dishes is insufficient.	Use only dishwasher-proof sets.
	High level of salt in wash water.	Adjust the water hardness level using water hardness table.
	Salt compartment cap not closed properly.	Check that the salt compartment cap is closed properly.
	Too much salt spilled in the Dishwasher while filling it with salt.	Use funnel while filling salt to the compartment to avoid spillage.
	A poor mains grounding.	Consult a qualified electrician immediately.
Detergent remains in the detergent compartment.	Detergent was added when the detergent compartment was wet.	Make sure detergent compartment is dry before use.

Product support

Help is always at hand

AUTOMATIC FAULT WARNINGS AND WHAT TO DO

TROUBLE CODE	POSSIBLE FAULT	WHAT TO DO
F5	Insufficient water	Make sure the water inlet tap is open and water is flowing
		Separate the inlet hose from the tap and clean the filter of the hose.
		Contact for service if the error continues.
F3	Continuous water input	Close the tap and contact for service.
F2	Inability to discharge water	Water discharge hose and filters may be clogged.
		Cancel the program.
		If the error continues, contact for service.
F8	Heater error	Contact for service.
F1	Overflow	Unplug the machine and close the tap.
		Contact for service.
FE	Faulty electronic card	Contact for service.
F7	Overheating	Contact for service.
F9	Divisor position error	Contact for service.
F6	Faulty heater sensor	Contact for service.

PRACTICAL INFORMATION

1. When the machine isn't in operation:
 - Disconnect the plug and close the tap.
 - Leave the door slightly open to prevent odour formation.
2. Select the dry option to remove water droplets.
3. Place dishes in the machine properly to achieve the best energy consumption, washing and drying performance. Please see the programme and consumption table for more information.
4. Rinse dirty dishes before placing them in the dishwasher.
5. Only use the Prewash programme when necessary.
6. Do not place the machine near a refrigerator because it will reach high temperatures.
7. If the machine is located in an area that is at risk of freezing, close the tap, disconnect the inlet hose from the tap and drain the water inside the hose and the machine completely.

If you require any technical guidance or find that your product is not operating as intended, a simple solution can often be found in the **Troubleshooting** section of these instructions, or online at www.newworldassist.co.uk. If you still require further assistance, call one of our experts on "03 305 2263".



Product support

Help is always at hand

Help and assistance

If you require any technical guidance or find that your Dishwasher is not operating as intended, a simple solution can often be found in the **Troubleshooting** section of these instructions or online at www.newworldassist.co.uk

If you still require further assistance, call one of our experts on **0333 305 2263**. To help give us give you a fast and efficient service please have the following information ready:

Model Ref.	<input type="text"/>	You can find these on the rating plate - a small information panel (usually a sticker or metal plate) on the rear of your appliance
Serial number	<input type="text"/>	
Date of purchase	<input type="text"/>	This will be shown on your receipt

Lines open 8am-7pm Monday to Saturday and 9am-5pm Sunday.

*Calls to New World enquiry lines may attract a charge and set up fee from residential lines depending on your call plan/tariff. Mobile and other providers costs may vary, see www.bt.com/pricing for details.

For Security and training purposes, telephone calls to and from customer service centres maybe recorded and monitored. Calls from Republic of Ireland will attract international call charges.

Product support

Help is always at hand

Declaration of conformance to product standards

We declare that our products meet the applicable European Directives, Decisions and Regulations and the requirements listed in the standards referenced.

Packaging and the Environment

Packaging materials protect your machine from damage that may occur during transportation. The packaging materials are environmentally friendly as they are recyclable. The use of recycled material reduces raw material consumption and therefore decreases waste production.

Recycling

- Some machine components and packaging consist of recyclable materials.
- Plastics are marked with the international abbreviations: (>PE<, >PP<, etc.)
- The cardboard parts consist of recycled paper. They can be put into waste paper containers for recycling.
- Material unsuitable for domestic waste must be disposed of at recycling centres.
- Contact a relevant recycling centre to obtain information about disposal of different materials.

Disposal



The symbol on the product or on its packaging indicates that this product may not be treated as household waste. Instead, it shall be handed over to the applicable collection point for the recycling of electrical and electronic equipment. By ensuring this product is disposed of correctly, you will help prevent potential negative consequences for the environment and human health, which could otherwise be caused by inappropriate waste handling of this product. For more detailed information about recycling of this product, please contact your local city office, your household waste disposal service or the shop where the product was purchased.



Call us now and activate your 24 month guarantee

Thank you for choosing New World. Your new product is guaranteed against faults and breakdowns for 24 months. Don't forget to register it with us today so we can provide you with our best possible after-sales service and useful updates.

www.newworldassist.co.uk

0333 305 2263

Your New World Guarantee

This product is guaranteed for twenty-four months from the date of original purchase. Any defect that arises due to faulty materials or workmanship will be repaired free of charge (or if applicable the product will be replaced or the purchase price refunded) where possible during this period by the dealer from who your purchased the unit.

The guarantee is subject to the following provisions:

- The guarantee does not cover accidental damage, misuse, cabinet parts, knobs or consumable items.
- The product must be correctly installed and operated in accordance with the instructions contained in the manual.
- It must be used solely for domestic purposes. The guarantee will be rendered invalid if the product is re-sold or has been damaged by inexpert repair.
- Specifications are subject to change without notice.
- We disclaim any liability for loss or damage arising from the breakdown of the product.
- This guarantee is in addition to and does not diminish your statutory or legal rights.

Important Data Protection Information

To find out how we use your data please refer to the guarantee registration material or visit

www.newworldassist.co.uk



Contact:

www.newworldassist.co.uk

Helpline: **0333 305 2263**

52279210 R35