

Chile - 3FT Bed

Assembly Instructions - Please keep for future reference

482/1254

501/5856

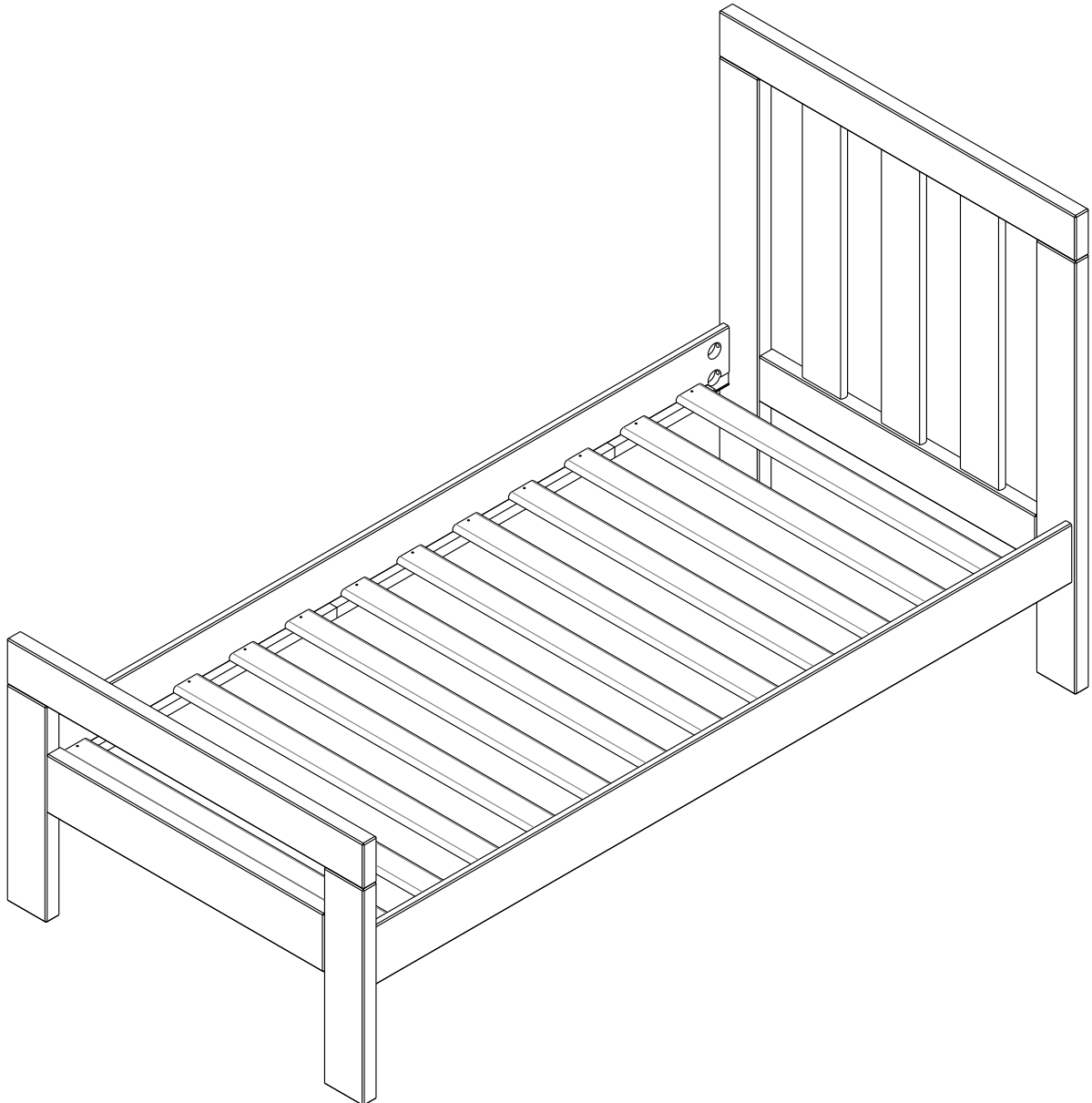

Dimensions

Width - 97.1cm

Depth - 197.6cm

Height - 112.8cm

Important – Please read these instructions fully before starting assembly

If you need help or have damaged or missing parts, call the **Customer Helpline: 03456 400 800**



Safety and Care Advice

Important – Please read these instructions fully before starting assembly

- Check you have all the components and tools listed on pages 2 and 3.
- Remove all fittings from the plastic bags and separate them into their groups.
- Keep children and animals away from the work area, small parts could choke if swallowed.
- Make sure you have enough space to layout the parts before starting.
- Do not stand or put weight on the product, this could cause damage.
- Assemble the item as close to its final position (in the same room) as possible.
- Assemble on a soft level surface to avoid damaging the unit or your floor.

- This product has been produced from natural timber; you may notice some variation in the grain and colour of different component parts which is normal for furniture produced using natural wood and is not the result of any manufacturing fault.

- The product has been treated with a wax and oil finish to prevent dirt ingress and preserve moisture.

- On unpacking the furniture you may notice an odour due to this treatment; this will disappear once the furniture is unpacked and assembled after a period of time.

- This process may leave some staining on the packaging material; please take care to ensure this does not transfer to clothing or carpeted surfaces during assembly.



as this could damage the unit. Only use hand screwdrivers.

- We do not recommend the use of power drill/drivers **for inserting screws**,

- Parts of the assembly will be easier with 2 people.

- Dispose of all packaging carefully and responsibly.

Care and maintenance

- Use an appropriate furniture polish for natural wood furniture and a dry cloth to clean the product.
- Avoid placing the furniture in direct sunlight as this will cause the timber to prematurely age.

- From time to time check that there are no loose screws on this unit.

- This product should not be discarded with household waste. Take to your local authority waste disposal centre.

Note: If required the next page can be cut out and used as reference throughout the assembly. Keep this page with these instructions for future reference.

Components - Panels

Please check you have all the panels listed below

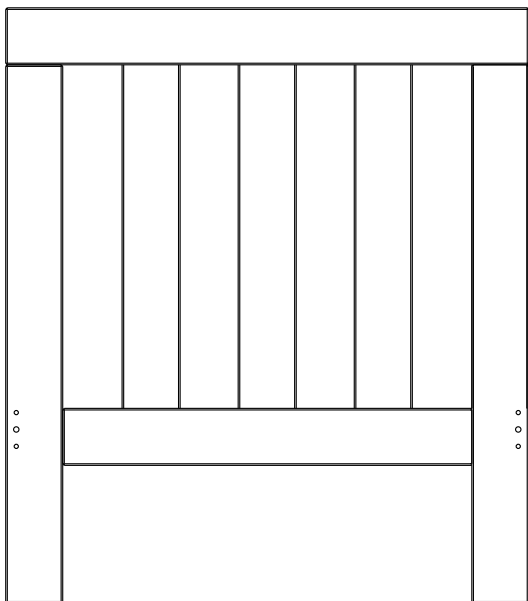

1 Headboard (112.8 x 97.1cm)

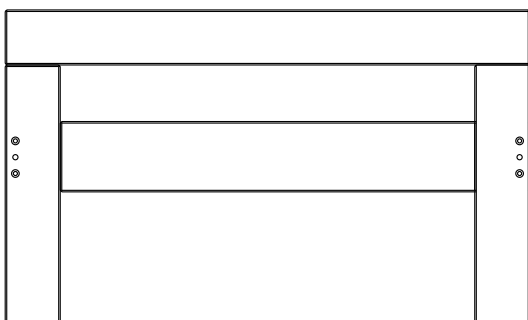

2 Footboard (61.8 x 97.1cm)

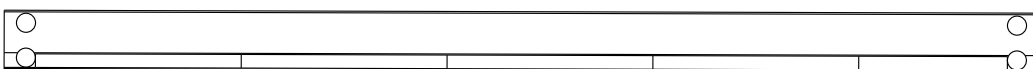

3 Side rail x 2 (190.0 x 14.0cm)



4 Slats x 12 (91 x 7.0cm)







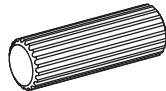
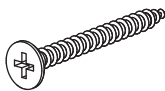

Components - Fittings

If you have damaged or missing components, call the **Customer Helpline: 03456 400 800**

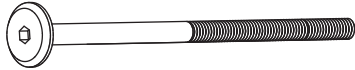
Please check you have all the fittings listed below

Note:

The quantities below are the correct amount to complete the assembly.
In some cases more fittings may be supplied than are required.

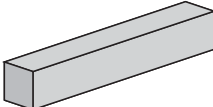
<p>A</p>  <p>Wooden dowel x 4 10 x 50mm</p>	<p>D</p>  <p>4 x 35mm Screw x 24</p>	<p>E</p>  <p>Headless bolt 1/4 x 75mm x 4</p>
<p>F</p>  <p>1/4 x 80mm Bolt x 4 Cab. 17</p>	<p>G</p>  <p>Half moon nut 1/4 x 4</p>	<p>H</p>  <p>Nut 1/4 x 4</p>
<p>K</p>  <p>Washer x 4 Cod. 330103</p>	<p>L</p>  <p>Spanner</p>	<p>M</p>  <p>Allen key x 1</p>
<p>N</p>  <p>82mm Spacer x 2</p>		

Tools required

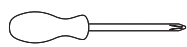

Phillips screwdriver
(medium & large)

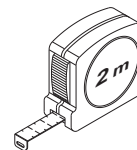

Ruler/tape
measure

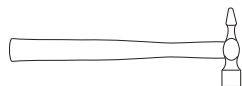

Small
hammer



Eye protection
(when using a
hammer or glue)

Ruler - Use this ruler to help correctly identify the screws



Assembly Instructions

Step1

Screw headless bolts **E** into footboard **2**.

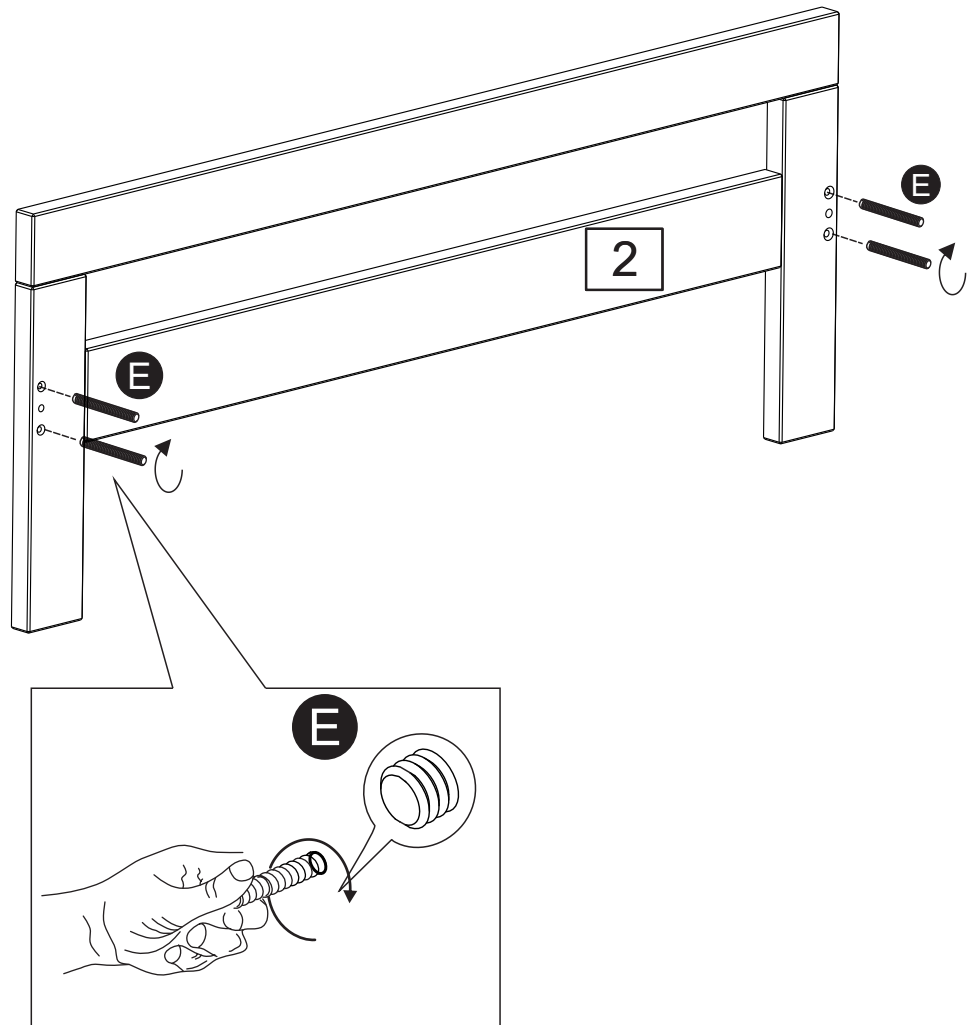

Step2

Insert dowels **A** into the side rails **3**.

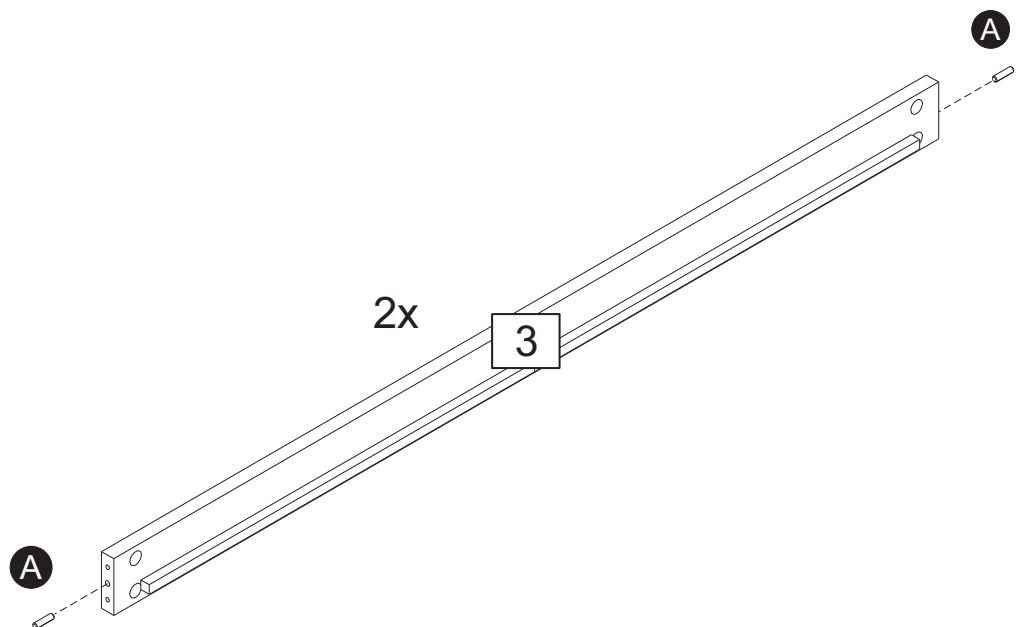

Assembly Instructions

Step 3

Assembling side rails.



Important:
Two people are required for an easier assembly.

With help, fit one side **3** to the headboard **1**. Insert half moon nuts **G** as shown, then fix parts using bolts **F** and allen key **M**.

Repeat step 5 for the other side rail.

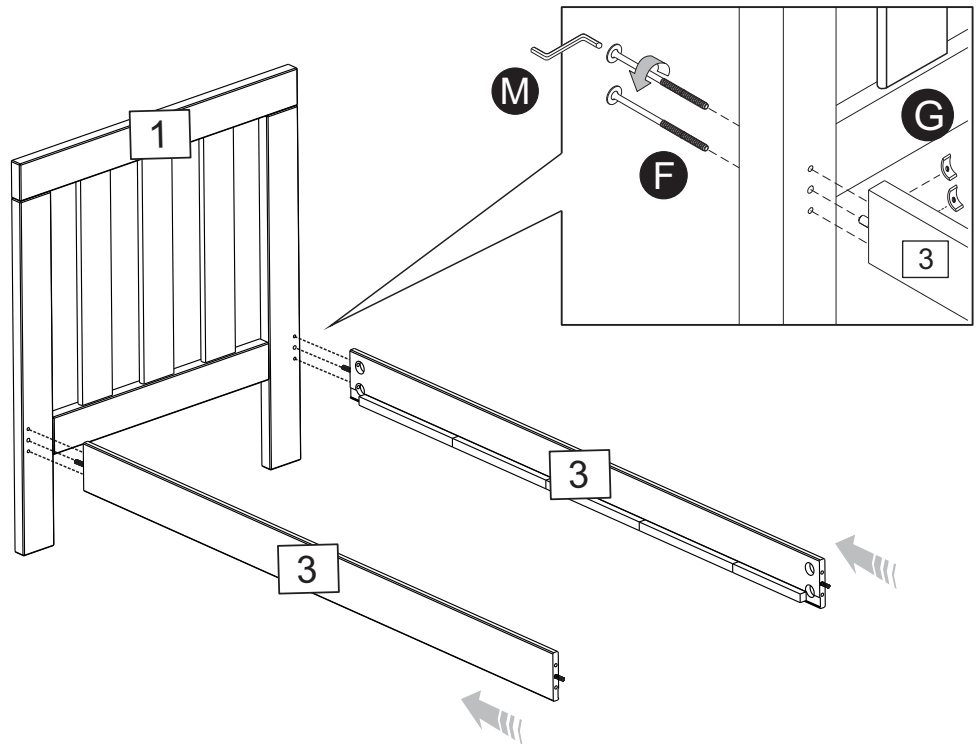

Step 4

a: Insert washer **K** into the side rails. Fit the headless bolts in the footboard through the washers.

b: Fix headless bolts **E** using nuts **H** and spanner **L**.

 Assembling of Step 5 and Step 6 will be easier with **2** people. It can also avoid damages or brakes of any part or component.

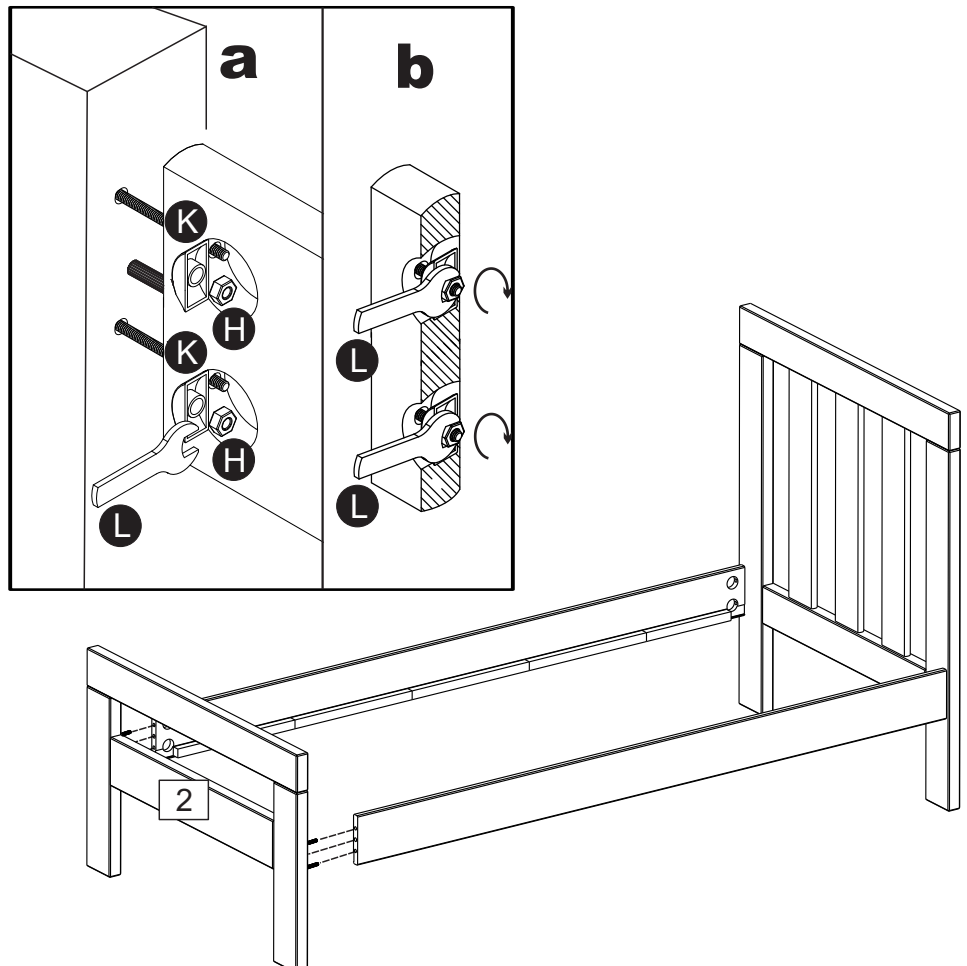

Assembly Instructions

Step 5

Assembling slats

Please fix the first slat at the end of the rail and work towards the middle of the bed using the spacer **N** as shown to ensure correct spacing.

Fix slats in one side first, then fix them in the other side by pushing the rail against the slats if necessary.

Use screws **D** for fixing.

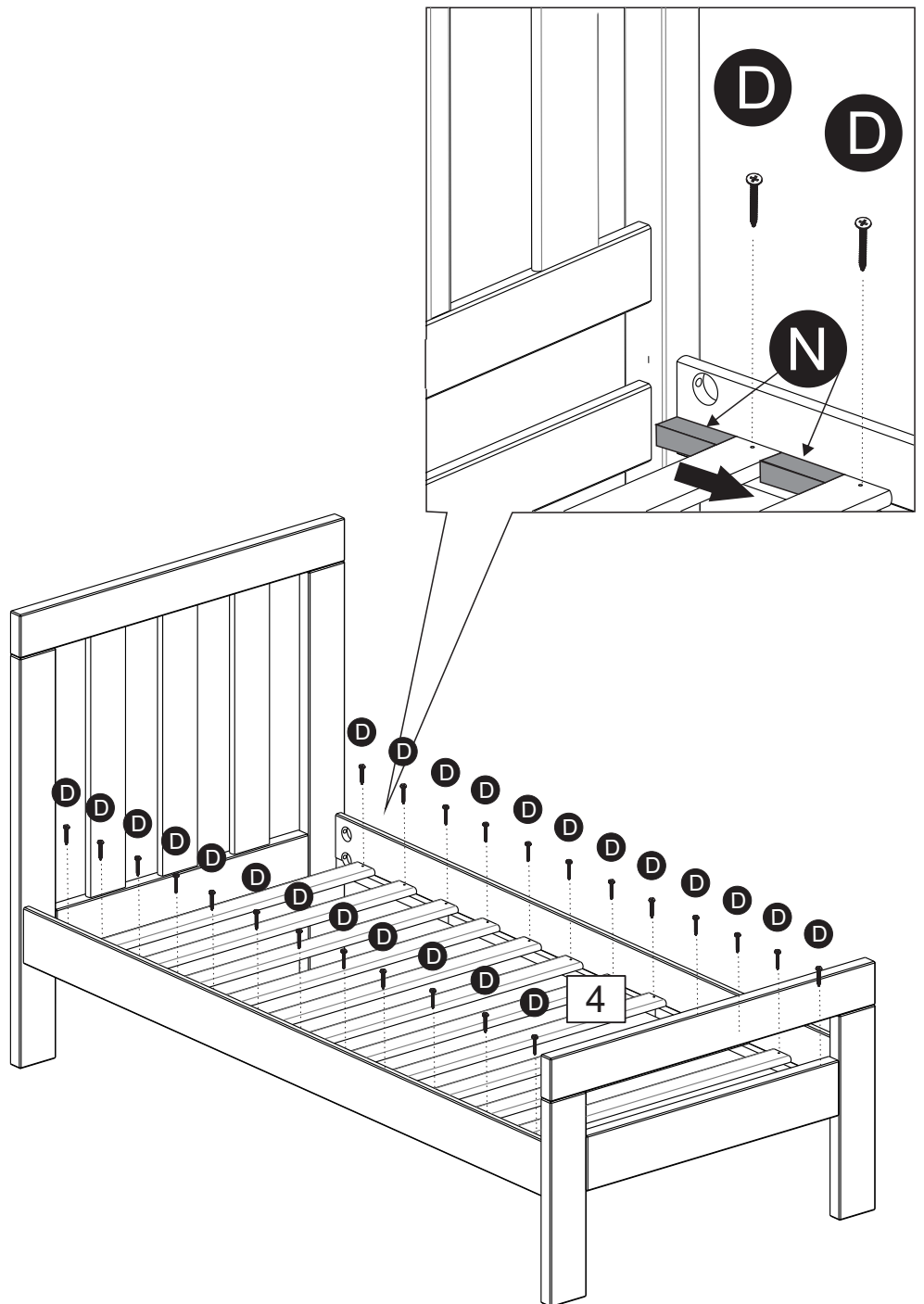

Assembly is complete.

If you need help or have damaged or missing parts, call the **Customer Helpline: 03456 400 800**